

## Inverter Grade Thyristors (Stud Version), 195 A



TO-209AB (TO-93)

**FEATURES**

- Center amplifying gate
- High surge current capability
- Low thermal impedance
- High speed performance
- Compression bonding
- Designed and qualified for industrial level
- Material categorization: For definitions of compliance please see [www.vishay.com/doc?99912](http://www.vishay.com/doc?99912)

**RoHS  
COMPLIANT**
**PRODUCT SUMMARY**

$I_{T(AV)}$	195 A
$V_{DRM}/V_{RRM}$	400 V, 800 V
$V_{TM}$	1.80 V
$I_{TSM}$ at 50 Hz	4900 A
$I_{TSM}$ at 60 Hz	5130 A
$I_{GT}$	200 mA
$T_J$	-40 °C to 125 °C
Package	TO-209AB (TO-93)
Diode variation	Single SCR

**TYPICAL APPLICATIONS**

- Inverters
- Choppers
- Induction heating
- All types of force-commutated converters

**MAJOR RATINGS AND CHARACTERISTICS**

PARAMETER	TEST CONDITIONS	VALUES	UNITS
$I_{T(AV)}$		195	A
	$T_C$	85	°C
$I_{T(RMS)}$		306	A
$I_{TSM}$	50 Hz	4900	
	60 Hz	5130	
$I^2t$	50 Hz	120	kA <sup>2</sup> s
	60 Hz	110	
$V_{DRM}/V_{RRM}$		400 to 800	V
$t_q$		15 to 20	µs
$T_J$		-40 to 125	°C

**ELECTRICAL SPECIFICATIONS**
**VOLTAGE RATINGS**

TYPE NUMBER	VOLTAGE CODE	$V_{DRM}/V_{RRM}$ , MAXIMUM REPETITIVE PEAK VOLTAGE V	$V_{RSM}$ , MAXIMUM NON-REPETITIVE PEAK VOLTAGE V	$I_{DRM}/I_{RRM}$ MAXIMUM AT $T_J = T_J$ MAXIMUM mA
VS-ST183S	04	400	500	40
	08	800	900	



CURRENT CARRYING CAPABILITY							
FREQUENCY							UNITS
50 Hz	570	370	900	610	7040	5220	A
400 Hz	560	360	940	630	3200	2280	
1000 Hz	500	300	925	610	1780	1200	
2500 Hz	340	190	760	490	880	560	
Recovery voltage $V_r$	50		50		50		V
Voltage before turn-on $V_d$	$V_{DRM}$		$V_{DRM}$		$V_{DRM}$		
Rise of on-state current $di/dt$	50		-		-		A/μs
Case temperature	60	85	60	85	60	85	°C
Equivalent values for RC circuit	47/0.22		47/0.22		47/0.22		Ω/μF

ON-STATE CONDUCTION						
PARAMETER	SYMBOL	TEST CONDITIONS			VALUES	UNITS
Maximum average on-state current at case temperature	$I_{T(AV)}$	180° conduction, half sine wave			195	A
					85	°C
Maximum RMS on-state current	$I_{T(RMS)}$	DC at 74 °C case temperature			306	A
Maximum peak, one half cycle, non-repetitive surge current	$I_{TSM}$	t = 10 ms	No voltage reappplied	Sinusoidal half wave, initial $T_J = T_J$ maximum	4900	
		t = 8.3 ms			5130	
		t = 10 ms	100 % $V_{RRM}$ reappplied		4120	
		t = 8.3 ms			4310	
Maximum $I^2t$ for fusing	$I^2t$	t = 10 ms	No voltage reappplied		120	
		t = 8.3 ms			110	
		t = 10 ms	100 % $V_{RRM}$ reappplied		85	
		t = 8.3 ms			78	
Maximum $I^2\sqrt{t}$ for fusing	$I^2\sqrt{t}$	t = 0.1 to 10 ms, no voltage reappplied			1200	$kA^2\sqrt{s}$
Maximum peak on-state voltage	$V_{TM}$	$I_{TM} = 600$ A, $T_J = T_J$ maximum, $t_p = 10$ ms sine wave pulse			1.80	V
Low level value of threshold voltage	$V_{T(TO)1}$	$(16.7\% \times \pi \times I_{T(AV)}) < I < \pi \times I_{T(AV)}$ , $T_J = T_J$ maximum			1.40	
High level value of threshold voltage	$V_{T(TO)2}$	$I > \pi \times I_{T(AV)}$ , $T_J = T_J$ maximum			1.45	
Low level value of forward slope resistance	$r_{t1}$	$(16.7\% \times \pi \times I_{T(AV)}) < I < \pi \times I_{T(AV)}$ , $T_J = T_J$ maximum			0.67	$m\Omega$
High level value of forward slope resistance	$r_{t2}$	$I > \pi \times I_{T(AV)}$ , $T_J = T_J$ maximum			0.58	
Maximum holding current	$I_H$	$T_J = 25$ °C, $I_T > 30$ A			600	mA
Typical latching current	$I_L$	$T_J = 25$ °C, $V_A = 12$ V, $R_a = 6$ Ω, $I_G = 1$ A			1000	



SWITCHING				
PARAMETER	SYMBOL	TEST CONDITIONS	VALUES	UNITS
Maximum non-repetitive rate of rise of turned-on current	di/dt	T <sub>J</sub> = T <sub>J</sub> maximum, V <sub>DRM</sub> = Rated V <sub>DRM</sub> I <sub>TM</sub> = 2 x di/dt	1000	A/μs
Typical delay time	t <sub>d</sub>	T <sub>J</sub> = 25 °C, V <sub>DM</sub> = Rated V <sub>DRM</sub> , I <sub>TM</sub> = 50 A DC, t <sub>p</sub> = 1 μs Resistive load, gate pulse: 10 V, 5 Ω source	1.1	μs
Maximum turn-off time	minimum	T <sub>J</sub> = T <sub>J</sub> maximum, I <sub>TM</sub> = 300 A, commutating di/dt = 20 A/μs V <sub>R</sub> = 50 V, t <sub>p</sub> = 500 μs, dV/dt: 200 V/μs	15	
	maximum		20	

BLOCKING				
PARAMETER	SYMBOL	TEST CONDITIONS	VALUES	UNITS
Maximum critical rate of rise of off-state voltage	dV/dt	T <sub>J</sub> = T <sub>J</sub> maximum, linear to 80 % V <sub>DRM</sub> , higher value available on request	500	V/μs
Maximum peak reverse and off-state leakage current	I <sub>RRM</sub> , I <sub>DRM</sub>	T <sub>J</sub> = T <sub>J</sub> maximum, rated V <sub>DRM</sub> /V <sub>RRM</sub> applied	40	mA

TRIGGERING				
PARAMETER	SYMBOL	TEST CONDITIONS	VALUES	UNITS
Maximum peak gate power	P <sub>GM</sub>	T <sub>J</sub> = T <sub>J</sub> maximum, f = 50 Hz, d% = 50	60	W
Maximum average gate power	P <sub>G(AV)</sub>		10	
Maximum peak positive gate current	I <sub>GM</sub>	T <sub>J</sub> = T <sub>J</sub> maximum, t <sub>p</sub> ≤ 5 ms	10	A
Maximum peak positive gate voltage	+ V <sub>GM</sub>		20	V
Maximum peak negative gate voltage	- V <sub>GM</sub>		5	
Maximum DC gate current required to trigger	I <sub>GT</sub>	T <sub>J</sub> = T <sub>J</sub> maximum V <sub>A</sub> = 12 V, R <sub>a</sub> = 6 Ω	200	mA
Maximum DC gate voltage required to trigger	V <sub>GT</sub>		3	V
Maximum DC gate current not to trigger	I <sub>GD</sub>	T <sub>J</sub> = T <sub>J</sub> maximum, rated V <sub>DRM</sub> applied	20	mA
Maximum DC gate voltage not to trigger	V <sub>GD</sub>		0.25	V

THERMAL AND MECHANICAL SPECIFICATIONS				
PARAMETER	SYMBOL	TEST CONDITIONS	VALUES	UNITS
Maximum junction operating temperature range	T <sub>J</sub>		-40 to 125	°C
Maximum storage temperature range	T <sub>Stg</sub>		-40 to 150	
Maximum thermal resistance, junction to case	R <sub>thJC</sub>	DC operation	0.105	K/W
Maximum thermal resistance, case to heatsink	R <sub>thCS</sub>	Mounting surface, smooth, flat and greased	0.04	
Mounting torque, ± 10 %		Non-lubricated threads	31 (275)	N · m (lbf · in)
		Lubricated threads	24.5 (210)	
Approximate weight			280	g
Case style		See dimensions - link at the end of datasheet	TO-209AB (TO-93)	

ΔR <sub>thJC</sub> CONDUCTION				
CONDUCTION ANGLE	SINUSOIDAL CONDUCTION	RECTANGULAR CONDUCTION	TEST CONDITIONS	UNITS
180°	0.016	0.012	T <sub>J</sub> = T <sub>J</sub> maximum	K/W
120°	0.019	0.020		
90°	0.025	0.027		
60°	0.036	0.037		
30°	0.060	0.060		

**Note**

- The table above shows the increment of thermal resistance R<sub>thJC</sub> when devices operate at different conduction angles than DC

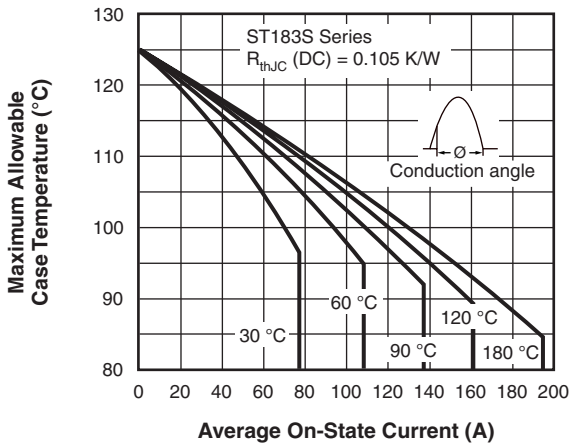

Fig. 1 - Current Ratings Characteristics

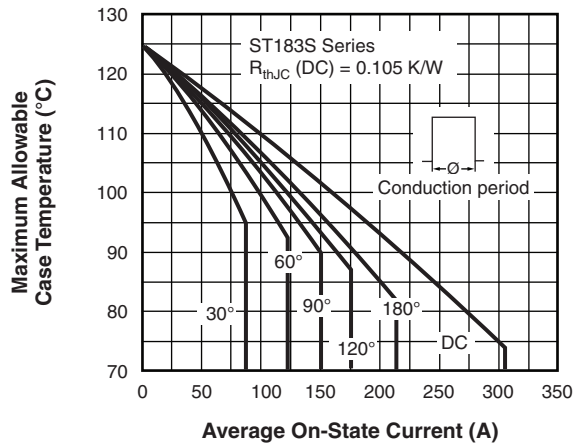

Fig. 2 - Current Ratings Characteristics

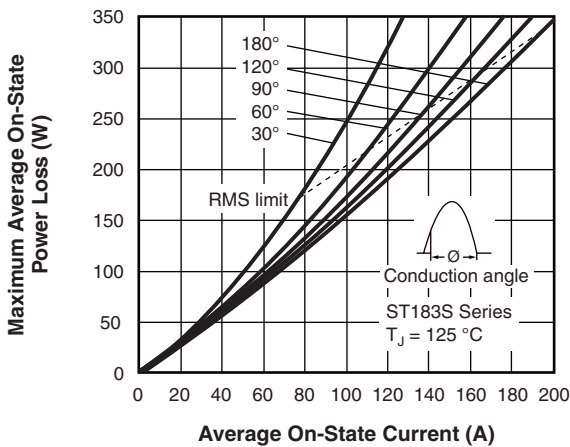

Fig. 3 - On-State Power Loss Characteristics

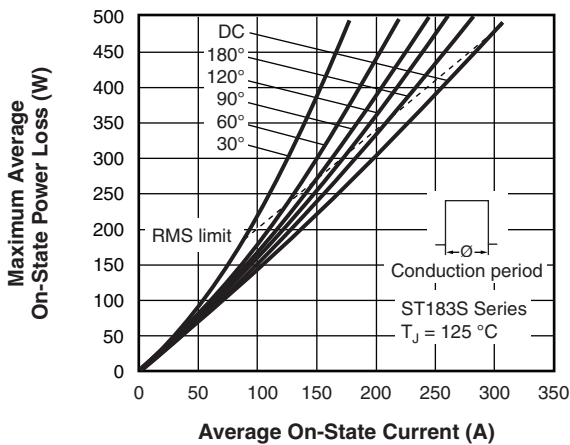
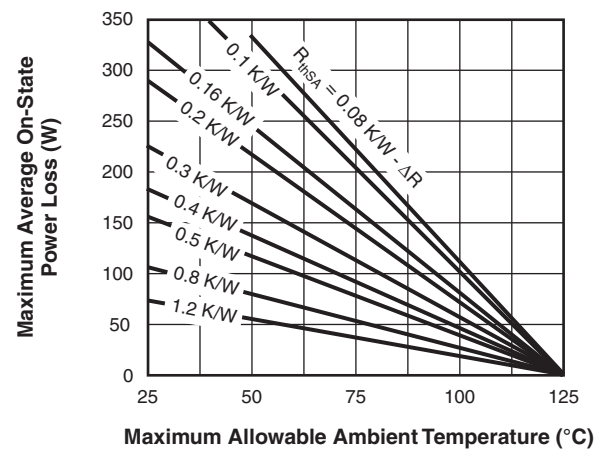
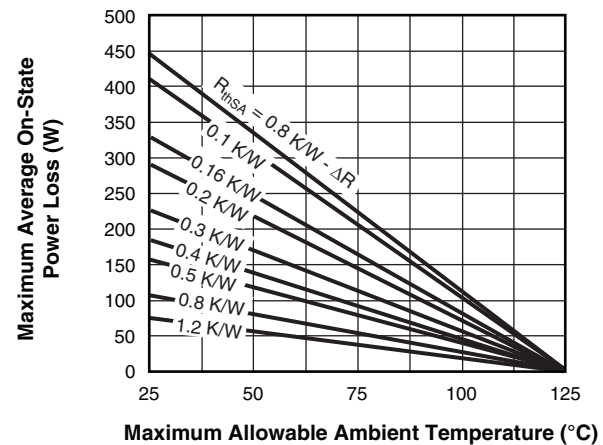

Fig. 4 - On-State Power Loss Characteristics



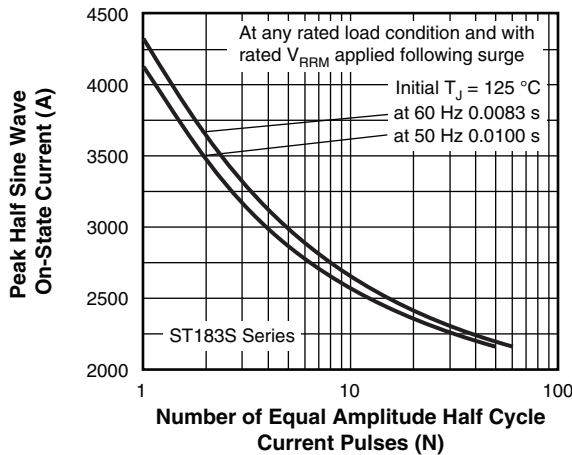

Fig. 5 - Maximum Non-Repetitive Surge Current

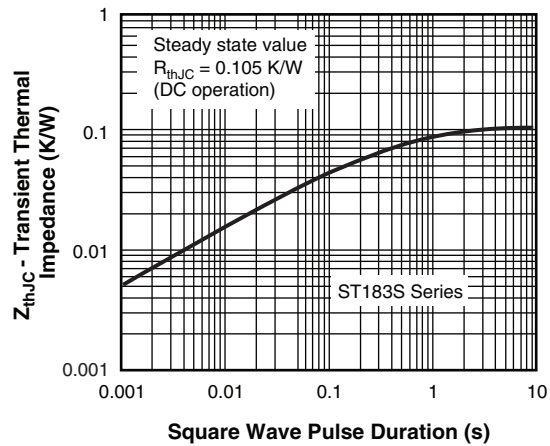

Fig. 8 - Thermal Impedance  $Z_{thJC}$  Characteristics

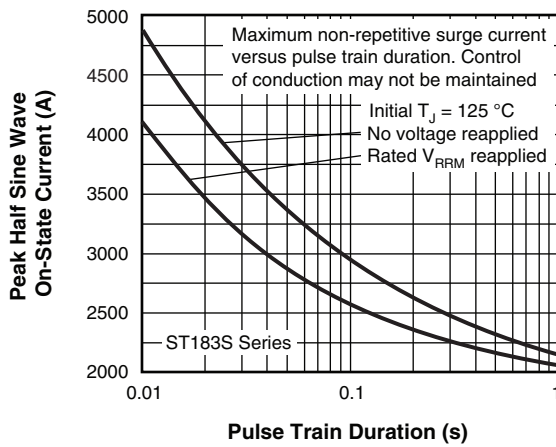

Fig. 6 - Maximum Non-Repetitive Surge Current

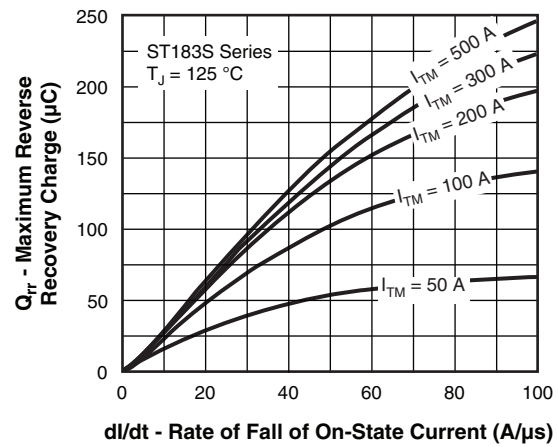

Fig. 9 - Reverse Recovered Charge Characteristics

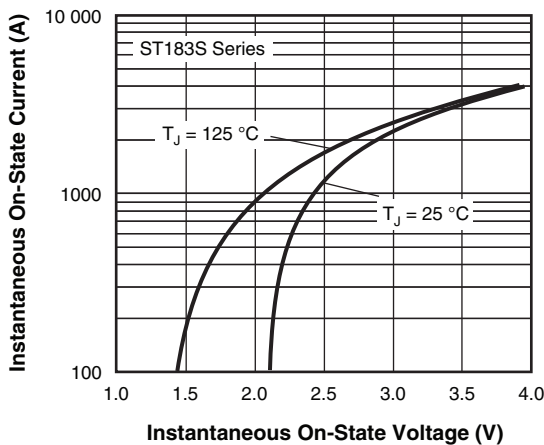

Fig. 7 - On-State Voltage Drop Characteristics

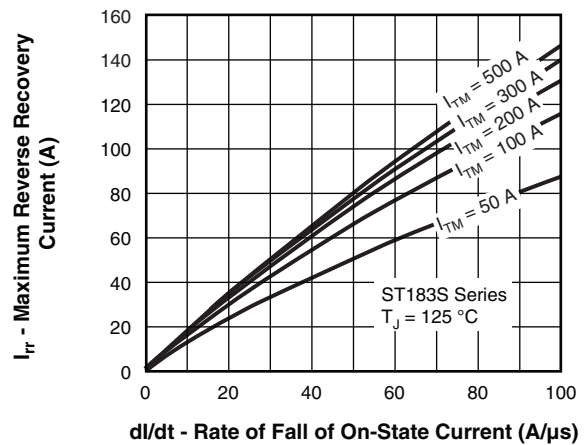

Fig. 10 - Reverse Recovery Current Characteristics

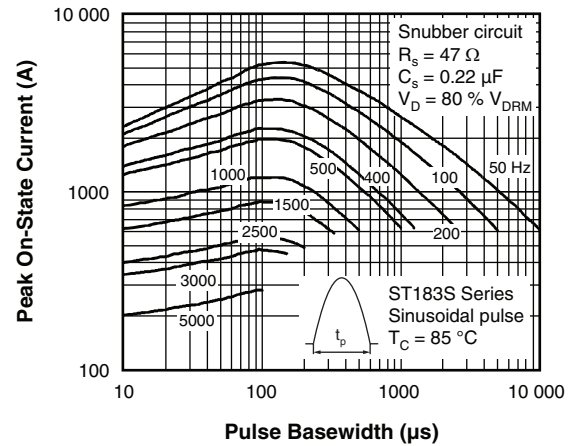
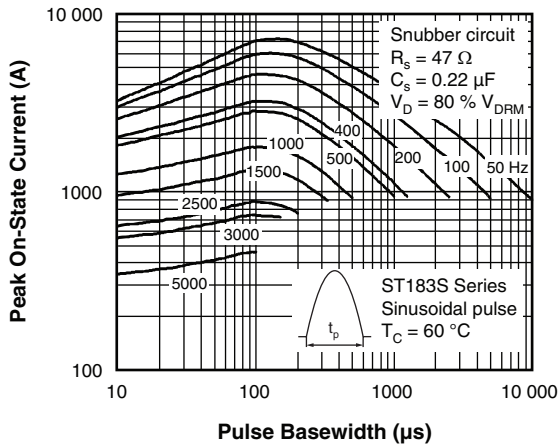

Fig. 11 - Frequency Characteristics

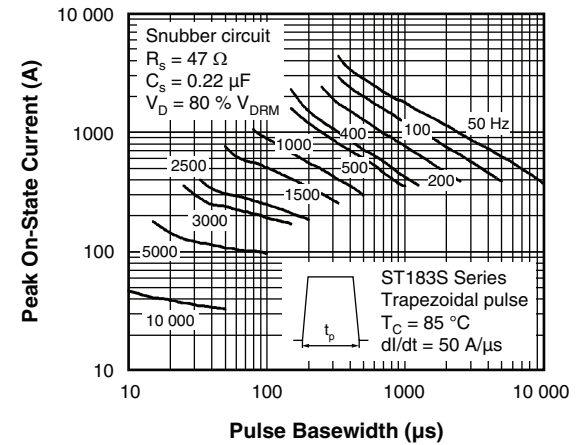
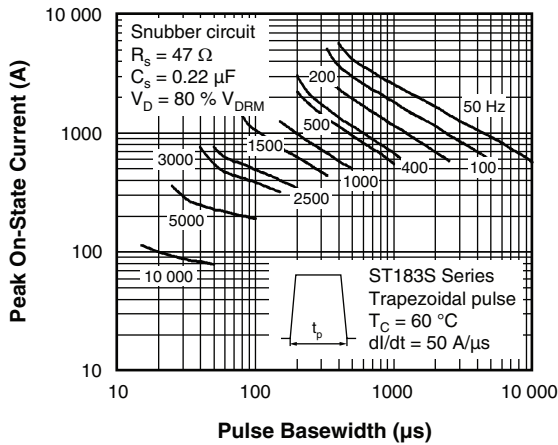

Fig. 12 - Frequency Characteristics

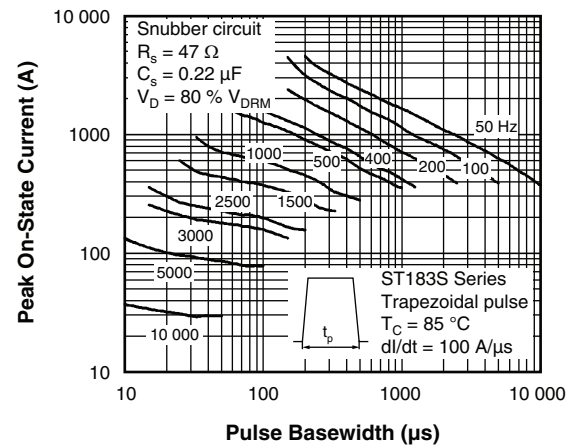
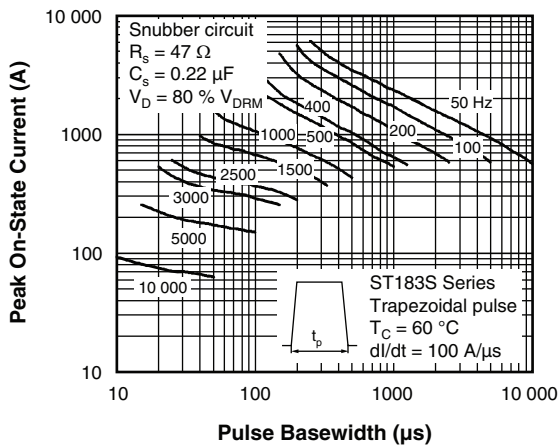

Fig. 13 - Frequency Characteristics

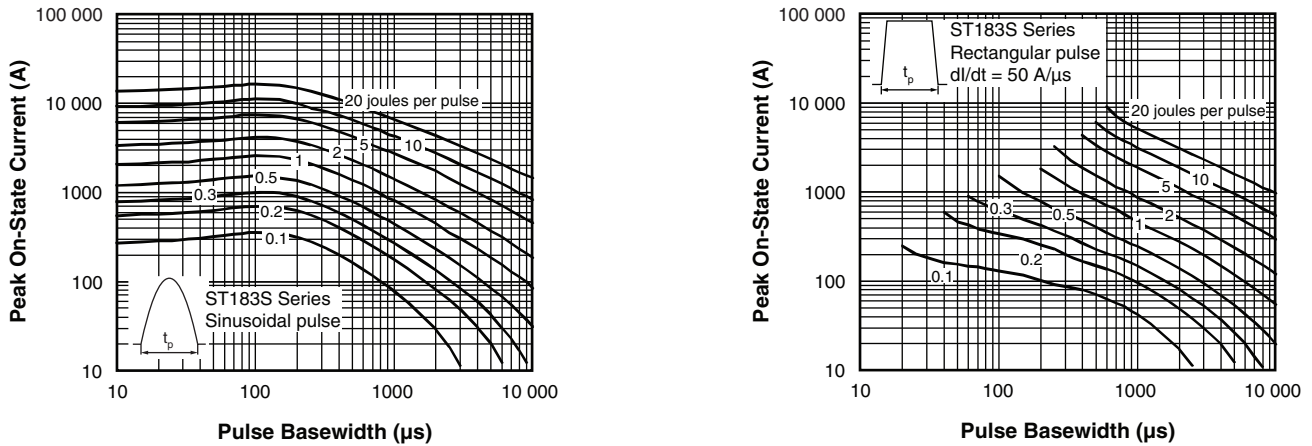

Fig. 14 - Maximum On-State Energy Power Loss Characteristics

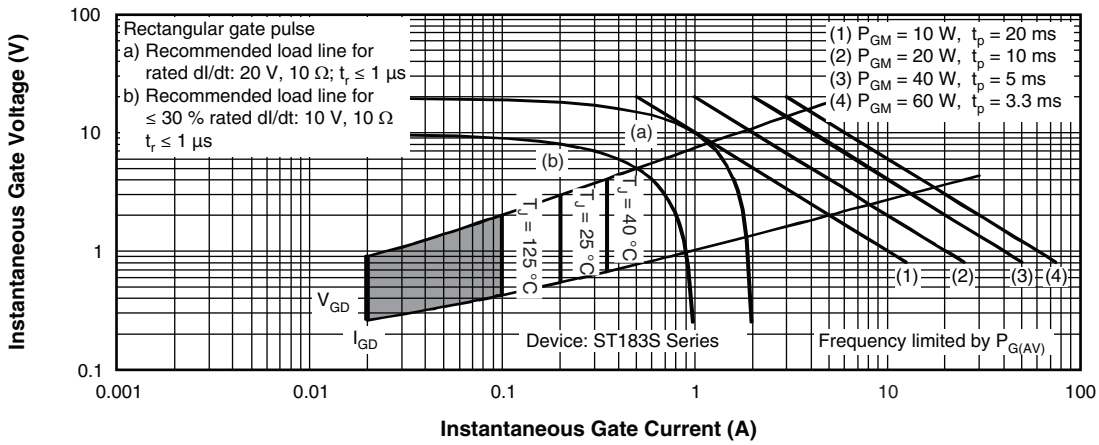
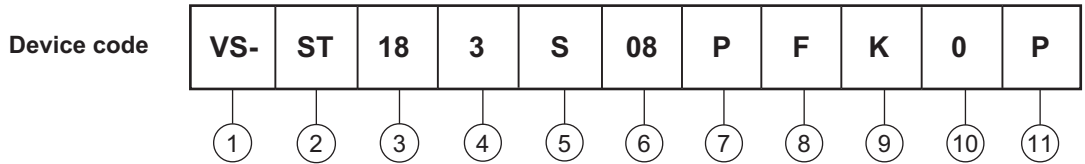

Fig. 15 - Gate Characteristics



## ORDERING INFORMATION TABLE



- 1** - Vishay Semiconductors product
- 2** - Thyristor
- 3** - Essential part number
- 4** - 3 = Fast turn-off
- 5** - S = Compression bonding stud
- 6** - Voltage code x 100 =  $V_{RRM}$  (see Voltage Ratings table)
- 7** - P = Stud base 3/4" 16UNF-2A
- 8** - Reapplied dV/dt code (for  $t_q$  test condition)
- 9** -  $t_q$  code
- 10** - 0 = Eyelet terminals  
(gate and auxiliary cathode leads)  
1 = Fast-on terminals  
(gate and auxiliary cathode leads)
- 11** - None = standard production  
P = Lead (Pb)-free

dV/dt - $t_q$ combinations available		
dV/dt (V/ $\mu$ s)		200
$t_q$ ( $\mu$ s)	15	FL
	20	FK

Note: For metric device M16 x 1.5 contact factory

LINKS TO RELATED DOCUMENTS	
Dimensions	<a href="http://www.vishay.com/doc?95077">www.vishay.com/doc?95077</a>



## TO-209AB (TO-93)

**DIMENSIONS** in millimeters (inches)

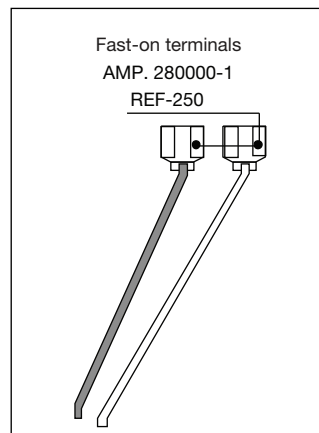
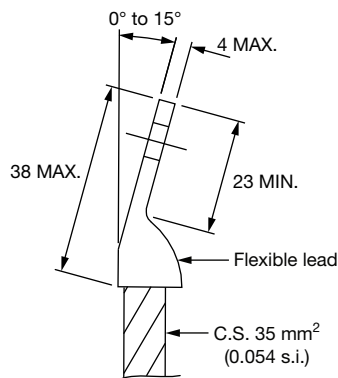
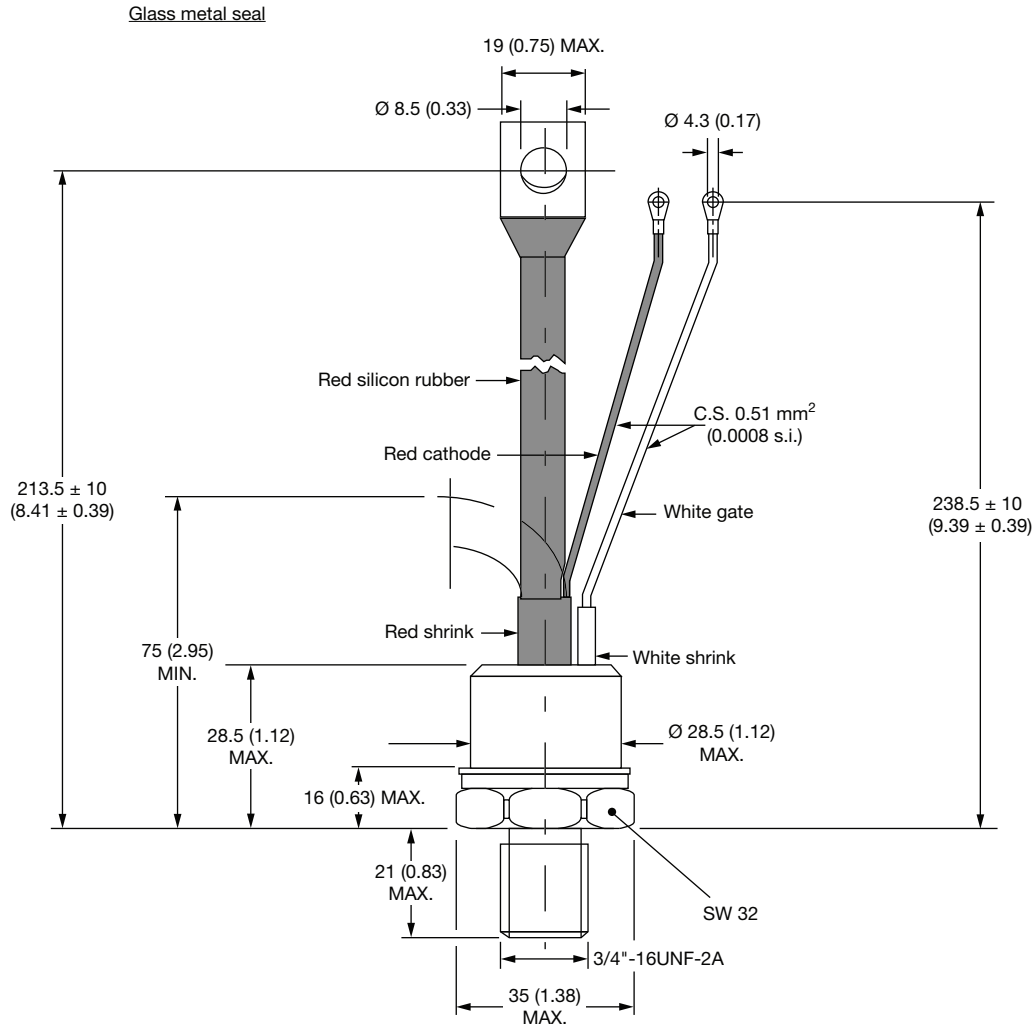



## Disclaimer

ALL PRODUCT, PRODUCT SPECIFICATIONS AND DATA ARE SUBJECT TO CHANGE WITHOUT NOTICE TO IMPROVE RELIABILITY, FUNCTION OR DESIGN OR OTHERWISE.

Vishay Intertechnology, Inc., its affiliates, agents, and employees, and all persons acting on its or their behalf (collectively, "Vishay"), disclaim any and all liability for any errors, inaccuracies or incompleteness contained in any datasheet or in any other disclosure relating to any product.

Vishay makes no warranty, representation or guarantee regarding the suitability of the products for any particular purpose or the continuing production of any product. To the maximum extent permitted by applicable law, Vishay disclaims (i) any and all liability arising out of the application or use of any product, (ii) any and all liability, including without limitation special, consequential or incidental damages, and (iii) any and all implied warranties, including warranties of fitness for particular purpose, non-infringement and merchantability.

Statements regarding the suitability of products for certain types of applications are based on Vishay's knowledge of typical requirements that are often placed on Vishay products in generic applications. Such statements are not binding statements about the suitability of products for a particular application. It is the customer's responsibility to validate that a particular product with the properties described in the product specification is suitable for use in a particular application. Parameters provided in datasheets and/or specifications may vary in different applications and performance may vary over time. All operating parameters, including typical parameters, must be validated for each customer application by the customer's technical experts. Product specifications do not expand or otherwise modify Vishay's terms and conditions of purchase, including but not limited to the warranty expressed therein.

Except as expressly indicated in writing, Vishay products are not designed for use in medical, life-saving, or life-sustaining applications or for any other application in which the failure of the Vishay product could result in personal injury or death. Customers using or selling Vishay products not expressly indicated for use in such applications do so at their own risk. Please contact authorized Vishay personnel to obtain written terms and conditions regarding products designed for such applications.

No license, express or implied, by estoppel or otherwise, to any intellectual property rights is granted by this document or by any conduct of Vishay. Product names and markings noted herein may be trademarks of their respective owners.

## Material Category Policy

**Vishay Intertechnology, Inc. hereby certifies that all its products that are identified as RoHS-Compliant fulfill the definitions and restrictions defined under Directive 2011/65/EU of The European Parliament and of the Council of June 8, 2011 on the restriction of the use of certain hazardous substances in electrical and electronic equipment (EEE) - recast, unless otherwise specified as non-compliant.**

**Please note that some Vishay documentation may still make reference to RoHS Directive 2002/95/EC. We confirm that all the products identified as being compliant to Directive 2002/95/EC conform to Directive 2011/65/EU.**

**Vishay Intertechnology, Inc. hereby certifies that all its products that are identified as Halogen-Free follow Halogen-Free requirements as per JEDEC JS709A standards. Please note that some Vishay documentation may still make reference to the IEC 61249-2-21 definition. We confirm that all the products identified as being compliant to IEC 61249-2-21 conform to JEDEC JS709A standards.**



## Стандарт Электрон Связь

Мы молодая и активно развивающаяся компания в области поставок электронных компонентов. Мы поставляем электронные компоненты отечественного и импортного производства напрямую от производителей и с крупнейших складов мира.

Благодаря сотрудничеству с мировыми поставщиками мы осуществляем комплексные и плановые поставки широчайшего спектра электронных компонентов.

Собственная эффективная логистика и склад в обеспечивает надежную поставку продукции в точно указанные сроки по всей России.

Мы осуществляем техническую поддержку нашим клиентам и предпродажную проверку качества продукции. На все поставляемые продукты мы предоставляем гарантию .

Осуществляем поставки продукции под контролем ВП МО РФ на предприятия военно-промышленного комплекса России , а также работаем в рамках 275 ФЗ с открытием отдельных счетов в уполномоченном банке. Система менеджмента качества компании соответствует требованиям ГОСТ ISO 9001.

Минимальные сроки поставки, гибкие цены, неограниченный ассортимент и индивидуальный подход к клиентам являются основой для выстраивания долгосрочного и эффективного сотрудничества с предприятиями радиоэлектронной промышленности, предприятиями ВПК и научно-исследовательскими институтами России.

С нами вы становитесь еще успешнее!

### Наши контакты:

**Телефон:** +7 812 627 14 35

**Электронная почта:** [sales@st-electron.ru](mailto:sales@st-electron.ru)

**Адрес:** 198099, Санкт-Петербург,  
Промышленная ул, дом № 19, литера Н,  
помещение 100-Н Офис 331