

SLI-343 Series

Features

- Viewing angle 2θ 1/2 / 40°
- High brightness
- Competent to direct mount



Specifications

Viewing angle 2θ 1/2 / 40°: High luminous intensity

Part No.	Chip Structure	Emitting Color	Absolute Maximum Ratings (Ta=25°C)					Electrical and Optical Characteristics (Ta=25°C)									
			Power Dissipation PD(mW)	Forward Current IF(mA)	Peak Forward Current I _F P(mA)	Reverse Voltage V _R (V)	Operating Temperature Topr(°C)	Storage Temperature Tstg(°C)	Forward Voltage V _f Typ.(V)	Reverse Current I _R Max.(μA)	Reverse Current I _R VR(V)	Dominant Wavelength λ D Typ.(nm)		Luminous Intensity I _v Min.(mcd) Typ.(mcd)		I _f (mA)	
■ SLI-343URC		Red										620			450		
■ SLI-343DC		Orange	125	50	200*		-25 to +85		1.9			605		90	500		
■ SLI-343YC		Yellow										587			350		
■ SLI-343MC	AlGaInP on GaAs	Yellowish Green	62	25	100*	9	-25 to +80	-30 to +100	2.1	20	100	9	572	20	56	200	20
■ SLI-343UR		Red															
■ SLI-343DU		Orange	125	50	200*		-25 to +85		1.9			605		90	500		
■ SLI-343YY		Yellow										587			300		
■ SLI-343MG		Yellowish Green	62	25	100*		-25 to +80		2.1			572		56	180		

*: Duty 1/10, 1kHz

Dimensions

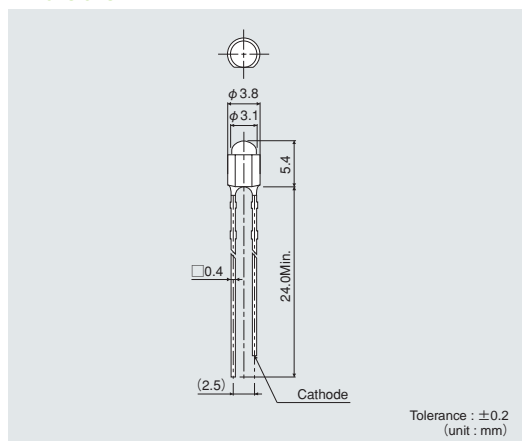

Recommended Solder Pattern

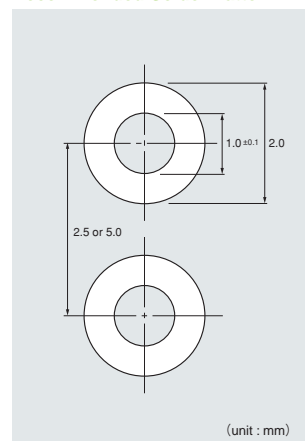

Viewing Angle

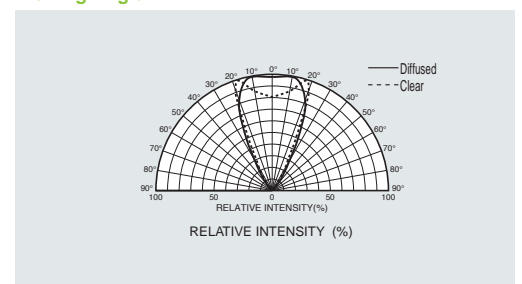

Electrical Characteristics Curves

Forward Current-Forward Voltage

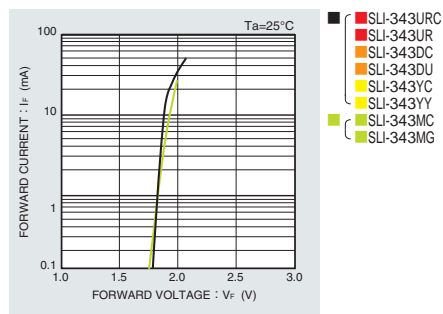

Luminous Intensity-Atmosphere Temperature

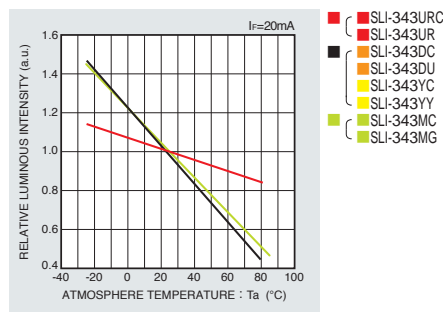

Luminous Intensity-Forward Current

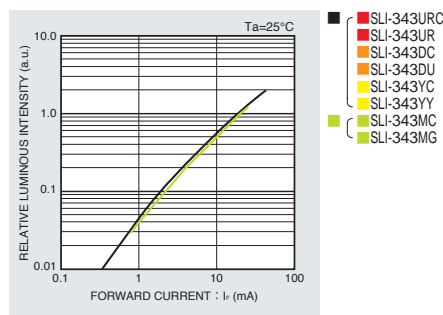

Derating

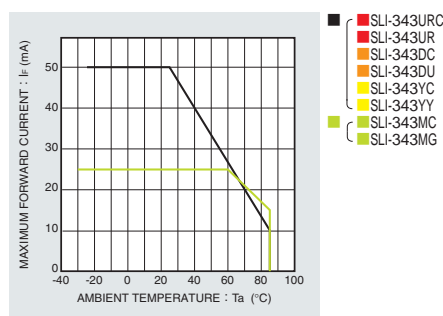

Rank Reference of Brightness

Red (U)

(Ta=25°C, If=20mA)

Viewing angle (2θ1/2)	Brightness Rank	Resin Color	Brightness (mcd)															
			E	F	G	H	J	K	L	M	N	P	Q	R	S	T	U	V
φ3 Circular type	40°	Transparent Colored	0.40 to 0.63	0.63 to 1.0	1.0 to 1.6	1.6 to 2.5	2.5 to 4.0	4.0 to 6.3	6.3 to 10	10 to 16	16 to 25	25 to 40	40 to 63	63 to 100	100 to 160	160 to 250	250 to 400	400 to 630
		Diffused Colored																

*SLI-343URC
*SLI-343UR

Orange (D)

(Ta=25°C, If=20mA)

Viewing angle (2θ1/2)	Brightness Rank	Resin Color	Brightness (mcd)															
			E	F	G	H	J	K	L	M	N	P	Q	R	S	T	U	V
φ3 Circular type	40°	Transparent Colored	0.40 to 0.63	0.63 to 1.0	1.0 to 1.6	1.6 to 2.5	2.5 to 4.0	4.0 to 6.3	6.3 to 10	10 to 16	16 to 25	25 to 40	40 to 63	63 to 100	100 to 160	160 to 250	250 to 400	400 to 630
		Diffused Colored																

*SLI-343DC
*SLI-343DU

Yellow (Y)

(Ta=25°C, If=20mA)

Viewing angle (2θ1/2)	Brightness Rank	Resin Color	Brightness (mcd)															
			E	F	G	H	J	K	L	M	N	P	Q	R	S	T	U	V
φ3 Circular type	40°	Transparent Colored	0.40 to 0.63	0.63 to 1.0	1.0 to 1.6	1.6 to 2.5	2.5 to 4.0	4.0 to 6.3	6.3 to 10	10 to 16	16 to 25	25 to 40	40 to 63	63 to 100	100 to 160	160 to 250	250 to 400	400 to 630
		Diffused Colored																

*SLI-343YC
*SLI-343YY

Green (M)

(Ta=25°C, If=20mA)

Viewing angle (2θ1/2)	Brightness Rank	Resin Color	Brightness (mcd)															
			E	F	G	H	J	K	L	M	N	P	Q	R	S	T	U	V
φ3 Circular type	40°	Transparent Colored	0.40 to 0.63	0.63 to 1.0	1.0 to 1.6	1.6 to 2.5	2.5 to 4.0	4.0 to 6.3	6.3 to 10	10 to 16	16 to 25	25 to 40	40 to 63	63 to 100	100 to 160	160 to 250	250 to 400	400 to 630
		Diffused Colored																

*SLI-343MC
*SLI-343MG

*Brightness on specification sheet include tolerance of within ± 10%.

Part No. Construction

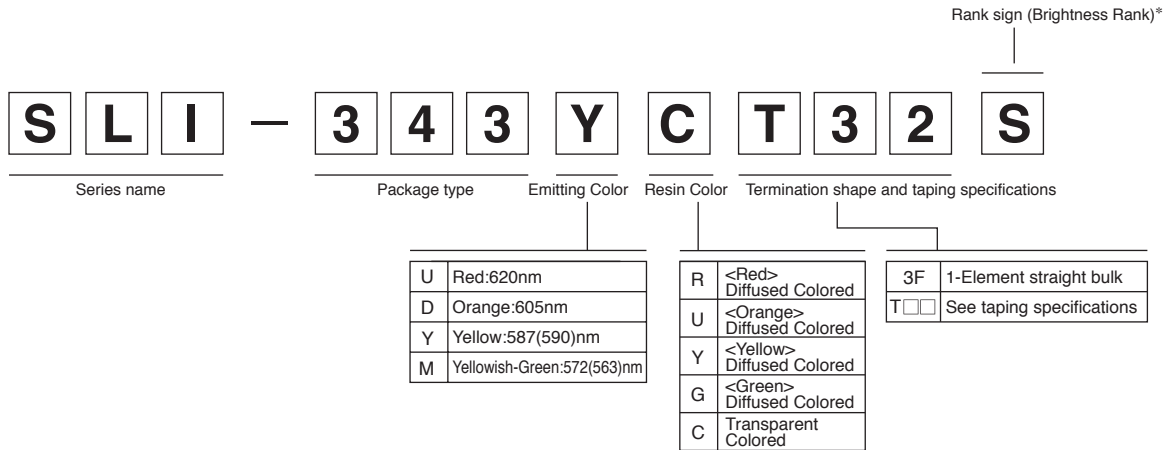

- * Concerning the Brightness rank
- Please refer to the rank chart above for luminous intensity classification.
- Part name is individual for each rank.
- When shipped as sample, the part name will be a representative part name.
- General products are free of ranks. Please contact sales if rank appointment is needed.

Notes

No copying or reproduction of this document, in part or in whole, is permitted without the consent of ROHM Co.,Ltd.

The content specified herein is subject to change for improvement without notice.

The content specified herein is for the purpose of introducing ROHM's products (hereinafter "Products"). If you wish to use any such Product, please be sure to refer to the specifications, which can be obtained from ROHM upon request.

Examples of application circuits, circuit constants and any other information contained herein illustrate the standard usage and operations of the Products. The peripheral conditions must be taken into account when designing circuits for mass production.

Great care was taken in ensuring the accuracy of the information specified in this document. However, should you incur any damage arising from any inaccuracy or misprint of such information, ROHM shall bear no responsibility for such damage.

The technical information specified herein is intended only to show the typical functions of and examples of application circuits for the Products. ROHM does not grant you, explicitly or implicitly, any license to use or exercise intellectual property or other rights held by ROHM and other parties. ROHM shall bear no responsibility whatsoever for any dispute arising from the use of such technical information.

The Products specified in this document are intended to be used with general-use electronic equipment or devices (such as audio visual equipment, office-automation equipment, communication devices, electronic appliances and amusement devices).

The Products specified in this document are not designed to be radiation tolerant.

While ROHM always makes efforts to enhance the quality and reliability of its Products, a Product may fail or malfunction for a variety of reasons.

Please be sure to implement in your equipment using the Products safety measures to guard against the possibility of physical injury, fire or any other damage caused in the event of the failure of any Product, such as derating, redundancy, fire control and fail-safe designs. ROHM shall bear no responsibility whatsoever for your use of any Product outside of the prescribed scope or not in accordance with the instruction manual.

The Products are not designed or manufactured to be used with any equipment, device or system which requires an extremely high level of reliability the failure or malfunction of which may result in a direct threat to human life or create a risk of human injury (such as a medical instrument, transportation equipment, aerospace machinery, nuclear-reactor controller, fuel-controller or other safety device). ROHM shall bear no responsibility in any way for use of any of the Products for the above special purposes. If a Product is intended to be used for any such special purpose, please contact a ROHM sales representative before purchasing.

If you intend to export or ship overseas any Product or technology specified herein that may be controlled under the Foreign Exchange and the Foreign Trade Law, you will be required to obtain a license or permit under the Law.



Thank you for your accessing to ROHM product informations.
More detail product informations and catalogs are available, please contact us.

ROHM Customer Support System

<http://www.rohm.com/contact/>



Стандарт Электрон Связь

Мы молодая и активно развивающаяся компания в области поставок электронных компонентов. Мы поставляем электронные компоненты отечественного и импортного производства напрямую от производителей и с крупнейших складов мира.

Благодаря сотрудничеству с мировыми поставщиками мы осуществляем комплексные и плановые поставки широчайшего спектра электронных компонентов.

Собственная эффективная логистика и склад в обеспечивает надежную поставку продукции в точно указанные сроки по всей России.

Мы осуществляем техническую поддержку нашим клиентам и предпродажную проверку качества продукции. На все поставляемые продукты мы предоставляем гарантию .

Осуществляем поставки продукции под контролем ВП МО РФ на предприятия военно-промышленного комплекса России , а также работаем в рамках 275 ФЗ с открытием отдельных счетов в уполномоченном банке. Система менеджмента качества компании соответствует требованиям ГОСТ ISO 9001.

Минимальные сроки поставки, гибкие цены, неограниченный ассортимент и индивидуальный подход к клиентам являются основой для выстраивания долгосрочного и эффективного сотрудничества с предприятиями радиоэлектронной промышленности, предприятиями ВПК и научно-исследовательскими институтами России.

С нами вы становитесь еще успешнее!

Наши контакты:

Телефон: +7 812 627 14 35

Электронная почта: sales@st-electron.ru

Адрес: 198099, Санкт-Петербург,
Промышленная ул, дом № 19, литера Н,
помещение 100-Н Офис 331