

features

- Dual-Input, Single-Output MOSFET Switch With No Reverse Current Flow (No Parasitic Diodes)
- IN1 . . . 250-mΩ, 500-mA N-Channel; 18-μA Supply Current
- IN2 . . . 1.3-Ω, 100-mA P-Channel; 0.75-μA Supply Current (V_{AUX} Mode)
- Advanced Switch Control Logic
- CMOS and TTL Compatible Enable Input
- Controlled Rise, Fall, and Transition Times
- 2.7 V to 5.5 V Operating Range
- SOT-23-5 and SOIC-8 Package
- -40°C to 85°C Ambient Temperature Range
- 2-kV Human Body Model, 750-V Charged Device Model, 200-V Machine-Model ESD Protection

typical applications

- Notebook and Desktop PCs
- Cell phone, Palmtops, and PDAs
- Battery Management

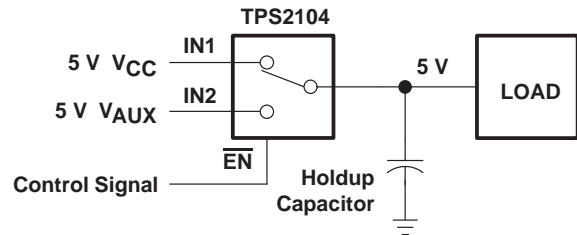
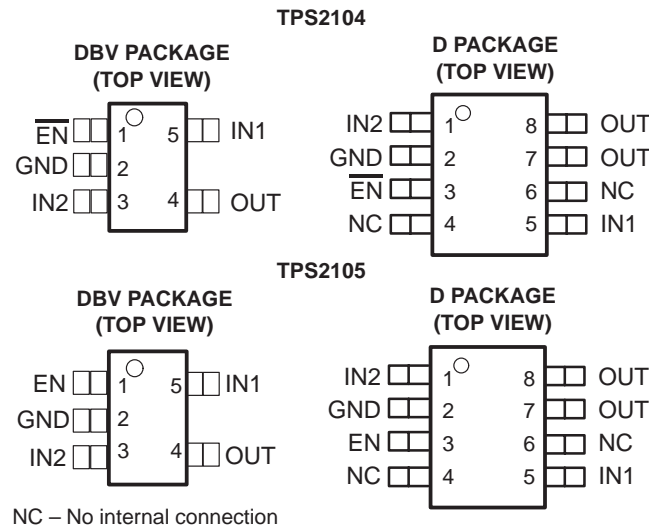

Figure 1. Typical Dual-Input Single-Output Application

description

The TPS2104 and TPS2105 are dual-input, single-output power switches designed to provide uninterrupted output voltage when transitioning between two independent power supplies. Both devices combine one n-channel (250 mΩ) and one p-channel (1.3 Ω) MOSFET with a single output. The p-channel MOSFET (IN2) is used with auxiliary power supplies that deliver lower current for standby modes. The n-channel MOSFET (IN1) is used with a main power supply that delivers higher current required for normal operation. Low on-resistance makes the n-channel the ideal path for higher main supply current when power-supply regulation and system voltage drops are critical. When using the p-channel MOSFET, quiescent current is reduced to 0.75 μA to decrease the demand on the standby power supply. The MOSFETs in the TPS2104 and TPS2105 do not have the parasitic diodes, typically found in discrete MOSFETs, thereby preventing back-flow current when the switch is off.



Please be aware that an important notice concerning availability, standard warranty, and use in critical applications of Texas Instruments semiconductor products and disclaimers thereto appears at the end of this data sheet.

PRODUCTION DATA information is current as of publication date. Products conform to specifications per the terms of Texas Instruments standard warranty. Production processing does not necessarily include testing of all parameters.



POST OFFICE BOX 655303 • DALLAS, TEXAS 75265

Copyright © 2000, Texas Instruments Incorporated

TPS2104, TPS2105 V_{AUX} POWER-DISTRIBUTION SWITCHES

SLVS235A – SEPTEMBER 1999 – REVISED APRIL 2000

Selection Guide, V_{AUX} Power-Distribution Switches

DEVICE	ENABLE	OPERATING VOLTAGE RANGE (V)	MAXIMUM INPUT CURRENT, IN1 (mA)	MAXIMUM INPUT CURRENT, IN2 (mA)	AMBIENT TEMPERATURE RANGE (°C)
TPS2100	$\overline{\text{EN}}$	2.7 to 4	500	10	-40 to 70
TPS2101	EN	2.7 to 4	500	10	-40 to 70
TPS2102	$\overline{\text{EN}}$	2.7 to 4	500	100	-40 to 70
TPS2103	EN	2.7 to 4	500	100	-40 to 70
TPS2104	$\overline{\text{EN}}$	2.7 to 5.5	500	100	-40 to 85
TPS2105	EN	2.7 to 5.5	500	100	-40 to 85

AVAILABLE OPTIONS FOR TPS2104, TPS2105

T _A	DEVICE	ENABLE	PACKAGED DEVICES	
			SOT-23-5 (DBV) [†]	SOIC-8 (D)
-40°C to 85°C	TPS2104	$\overline{\text{EN}}$	TSP2104DBV [†]	TPS2104D
	TPS2105	EN	TPS2105DBV [†]	TPS2105D

Both packages are available left-end taped and reeled. Add an R suffix to the D device type (e.g., TPS2105DR).

[†] Add T (e.g., TPS2104DBVT) to indicate tape and reel at order quantity of 250 parts.

Add R (e.g., TPS2104DBVR) to indicate tape and reel at order quantity of 3000 parts.

Function Tables

TPS2104			
VIN1	VIN2	$\overline{\text{EN}}$	OUT
0 V	0 V	XX	GND
0 V	5 V	L	GND
5 V	0 V	L	VIN1
5 V	5 V	L	VIN1
0 V	5 V	H	VIN2
5 V	0 V	H	VIN2
5 V	5 V	H	VIN2

TPS2105			
VIN1	VIN2	EN	OUT
0 V	0 V	XX	GND
0 V	5 V	H	GND
5 V	0 V	H	VIN1
5 V	5 V	H	VIN1
0 V	5 V	L	VIN2
5 V	0 V	L	VIN2
5 V	5 V	L	VIN2

XX = don't care

TPS2104 functional block diagram

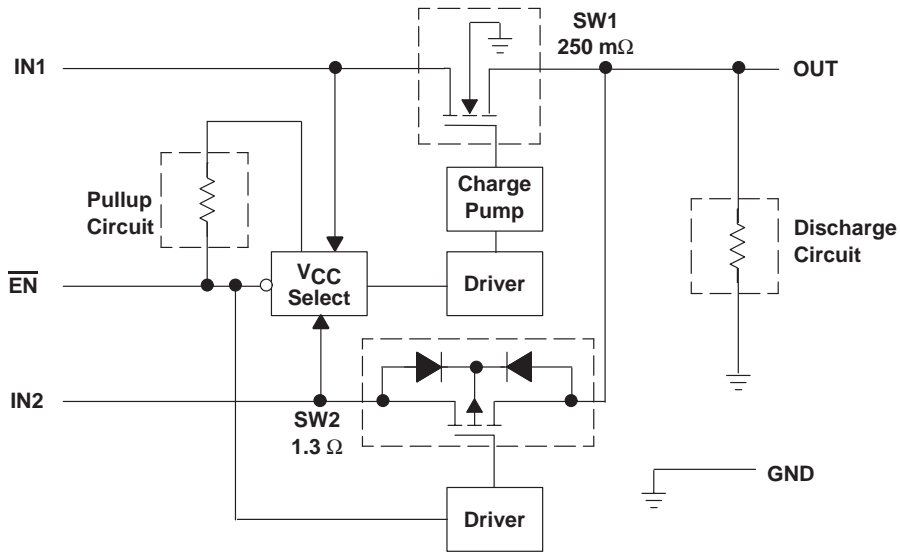

TPS2105 functional block diagram

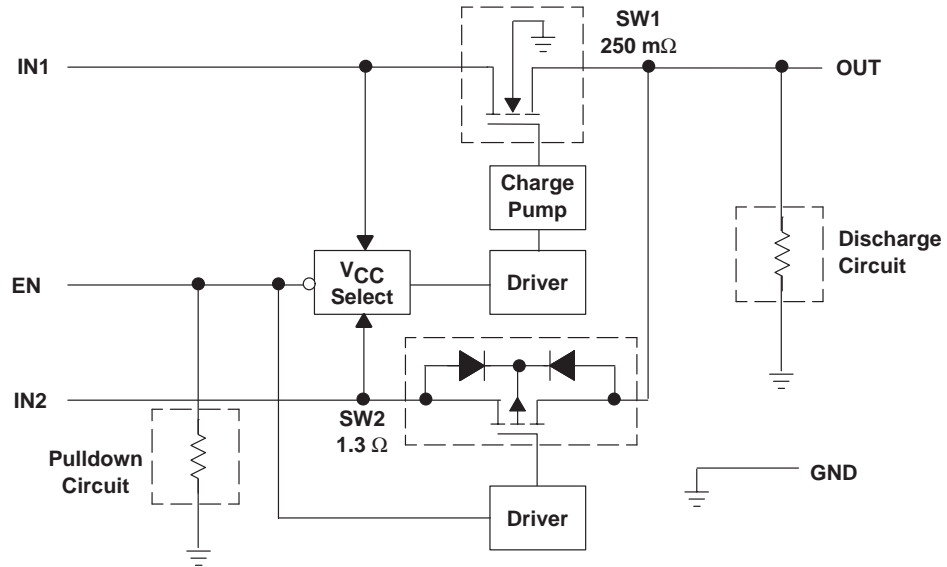

TPS2104, TPS2105

V_{AUX} POWER-DISTRIBUTION SWITCHES

SLVS235A – SEPTEMBER 1999 – REVISED APRIL 2000

Terminal Functions

NAME	TERMINAL NO.				I/O	DESCRIPTION
	TPS2104		TPS2105			
	DBV	D	DBV	D		
	EN			1		
$\overline{\text{EN}}$	1	3			I	Active-low enable for IN1-OUT switch
GND	2	2	2	2	I	Ground
IN1†	5	5	5	5	I	Main input voltage, NMOS drain (250 mΩ), require 0.22 μF bypass
IN2†	3	1	3	1	I	Auxilliary input voltage, PMOS drain (1.3 Ω), require 0.22 μF bypass
OUT	4	7, 8	4	7, 8	O	Power switch output
NC		4, 6		4, 6		No connection

† Unused INx should not be grounded.

detailed description

power switches

n-channel MOSFET

The IN1-OUT n-channel MOSFET power switch has a typical on-resistance of 250 mΩ at 5-V input voltage, and is configured as a high-side switch.

p-channel MOSFET

The IN2-OUT p-channel MOSFET power switch has a typical on-resistance of 1.3 Ω at 5-V input voltage and is configured as a high-side switch. When operating, the p-channel MOSFET quiescent current is reduced to typically 0.75 μA.

charge pump

An internal charge pump supplies power to the driver circuit and provides the necessary voltage to pull the gate of the MOSFET above the source. The charge pump operates from input voltages as low as 2.7 V and requires very little supply current.

driver

The driver controls the gate voltage of the IN1-OUT and IN2-OUT power switches. To limit large current surges and reduce the associated electromagnetic interference (EMI) produced, the drivers incorporate circuitry that controls the rise times and fall times of the output voltage.

enable

The logic enable will turn on the IN2-OUT power switch when a logic high is present on $\overline{\text{EN}}$ (TPS2104) or logic low is present on EN (TPS2105). A logic low input on $\overline{\text{EN}}$ (TPS2104) or logic high on EN (TPS2105) restores bias to the drive and control circuits and turns on the IN1-OUT power switch. The enable input is compatible with both TTL and CMOS logic levels.



absolute maximum ratings over operating free-air temperature (unless otherwise noted)†

Input voltage range, V _{I(IN1)} (see Note 1)	–0.3 V to 6 V
Input voltage range, V _{I(IN2)} (see Note 1)	–0.3 V to 6 V
Input voltage range, V _I at $\overline{\text{EN}}$ or EN (see Note 1)	–0.3 V to 6 V
Output voltage range, V _O (see Note 1)	–0.3 V to 6 V
Continuous output current, I _{O(IN1)}	700 mA
Continuous output current, I _{O(IN2)}	140 mA
Continuous total power dissipation	See dissipation rating table
Operating virtual junction temperature range, T _J	–40°C to 125°C
Storage temperature range, T _{stg}	–65°C to 150°C
Lead temperature soldering 1,6 mm (1/16 inch) from case for 10 seconds	260°C
Electrostatic discharge (ESD) protection: Human body model	2 kV
Machine model	200 V
Charged device model	750 V

† Stresses beyond those listed under “absolute maximum ratings” may cause permanent damage to the device. These are stress ratings only, and functional operation of the device at these or any other conditions beyond those indicated under “recommended operating conditions” is not implied. Exposure to absolute-maximum-rated conditions for extended periods may affect device reliability.

NOTE 1: All voltages are with respect to GND.

DISSIPATION RATING TABLE

PACKAGE	T _A < 25°C POWER RATING	DERATING FACTOR ABOVE T _A = 25°C	T _A = 70°C POWER RATING	T _A = 85°C POWER RATING
DBV	309 mW	3.1 mW/°C	170 mW	123 mW
D	568 mW	5.7 mW/°C	313 mW	227 mW

recommended operating conditions

	MIN	MAX	UNIT
Input voltage, V _{I(INx)}	2.7	5.5	V
Input voltage, V _I at $\overline{\text{EN}}$ and EN	0	5.5	V
Continuous output current, I _{O(IN1)}		500	mA
Continuous output current, I _{O(IN2)}		100‡	mA
Operating virtual junction temperature, T _J	–40	125	°C

‡ The device can deliver up to 220 mA at I_{O(IN2)}. However, operation at the higher current levels will result in greater voltage drop across the device, and greater voltage droop when switching between IN1 and IN2.

**electrical characteristics over recommended operating junction temperature range,
V_{I(IN1)} = V_{I(IN2)} = 5 V, I_O = rated current (unless otherwise noted)**

power switch

PARAMETER		TEST CONDITIONS†	MIN	TYP	MAX	UNIT
r _{DS(on)} On-state resistance	IN1-OUT	T _J = 25°C		250		mΩ
		T _J = 125°C		350	435	
	IN2-OUT	T _J = 25°C		1.3		Ω
		T _J = 125°C		1.5	2.4	

† Pulse-testing techniques maintain junction temperature close to ambient temperature; thermal effects must be taken into account separately.

TPS2104, TPS2105 V_{AUX} POWER-DISTRIBUTION SWITCHES

SLVS235A – SEPTEMBER 1999 – REVISED APRIL 2000

electrical characteristics over recommended operating junction temperature range,
V_{I(IN1)} = V_{I(IN2)} = 5 V, I_O = rated current (unless otherwise noted) (continued)

enable input (\overline{EN} and EN)

PARAMETER		TEST CONDITIONS	MIN	TYP	MAX	UNIT	
V _{IH}	High-level input voltage	2.7 V ≤ V _{I(INx)} ≤ 5.5 V	2			V	
V _{IL}	Low-level input voltage	2.7 V ≤ V _{I(INx)} ≤ 5.5 V			0.8	V	
I _I	Input current	TPS2104	$\overline{EN} = 0\text{ V}$ or $\overline{EN} = V_{I(INx)}$		-0.5	0.5	μA
		TPS2105	EN = 0 V or EN = V _{I(INx)}		-0.5	0.5	μA

supply current

PARAMETER		TEST CONDITIONS		MIN	TYP	MAX	UNIT
I _I	Supply current	TPS2104	$\overline{EN} = \text{H}$, IN2 selected	T _J = 25°C	0.75		μA
				-40°C ≤ T _J ≤ 125°C	1.5		
			TPS2105	$\overline{EN} = \text{L}$, IN1 selected	T _J = 25°C	18	
		-40°C ≤ T _J ≤ 125°C			35		
		EN = L, IN2 selected		T _J = 25°C	0.75		μA
			-40°C ≤ T _J ≤ 125°C	1.5			
EN = H, IN1 selected	T _J = 25°C	18		μA			
	-40°C ≤ T _J ≤ 125°C	35					

switching characteristics, T_J = 25°C, V_{I(IN1)} = V_{I(IN2)} = 5 V (unless otherwise noted)†

PARAMETER		TEST CONDITIONS†		MIN	TYP	MAX	UNIT
t _r	Output rise time	IN1-OUT	V _{I(IN2)} = 0	C _L = 1 μF, I _L = 500 mA	340		μs
				C _L = 10 μF, I _L = 500 mA	340		
				C _L = 1 μF, I _L = 100 mA	312		
		IN2-OUT	V _{I(IN1)} = 0	C _L = 1 μF, I _L = 100 mA	3.4		
				C _L = 10 μF, I _L = 100 mA	34		
				C _L = 1 μF, I _L = 10 mA	3.5		
t _f	Output fall time	IN1-OUT	V _{I(IN2)} = 0	C _L = 1 μF, I _L = 500 mA	6		μs
				C _L = 10 μF, I _L = 500 mA	108		
				C _L = 1 μF, I _L = 100 mA	8		
		IN2-OUT	V _{I(IN1)} = 0	C _L = 1 μF, I _L = 100 mA	100		
				C _L = 10 μF, I _L = 100 mA	990		
				C _L = 1 μF, I _L = 10 mA	1000		
t _{pLH}	Propagation delay time, low-to-high output	IN1-OUT	V _{I(IN2)} = 0	C _L = 10 μF, I _L = 100 mA	55		μs
		IN2-OUT	V _{I(IN1)} = 0		1		
t _{pHL}	Propagation delay time, high-to-low output	IN1-OUT	V _{I(IN2)} = 0	C _L = 10 μF, I _L = 100 mA	1.5		μs
		IN2-OUT	V _{I(IN1)} = 0		50		

† All timing parameters refer to Figure 2.



PARAMETER MEASUREMENT INFORMATION



LOAD CIRCUIT

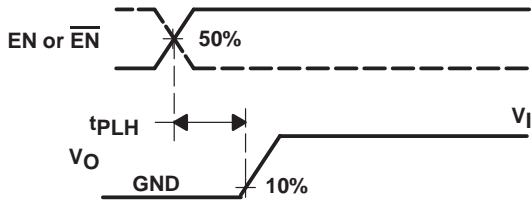

Propagation Delay Time, Low-to-High-Level Output

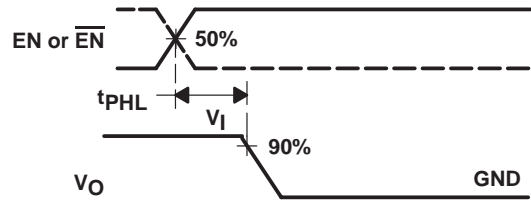

Propagation Delay Time, High-to-Low-Level Output



Rise/Fall Time

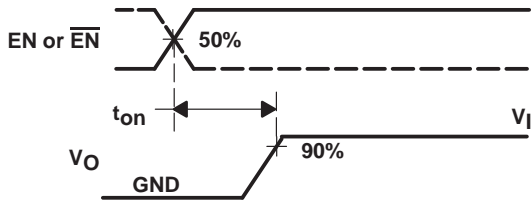

Turnon Transition Time

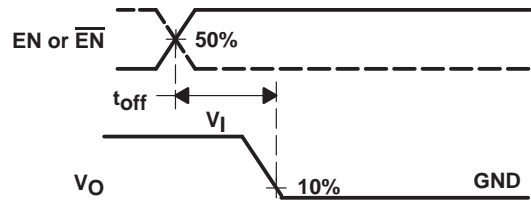

Turnoff Transition Time

WAVEFORMS

Figure 2. Test Circuit and Voltage Waveforms

Table of Timing Diagrams†

	FIGURE
Propagation Delay and Rise Time With 1- μ F Load, IN1	3
Propagation Delay and Rise Time With 1- μ F Load, IN2	4
Propagation Delay and Fall Time With 1- μ F Load, IN1	5
Propagation Delay and Fall Time With 1- μ F Load, IN2	6

† Waveforms shown in Figures 3–6 refer to TPS2104 at $T_J = 25^\circ\text{C}$

PARAMETER MEASUREMENT INFORMATION

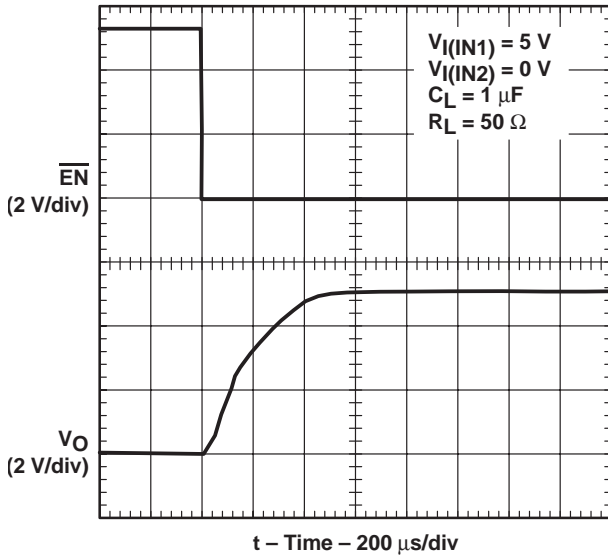

Figure 3. Propagation Delay and Rise Time With 1- μF Load, IN1 Turnon

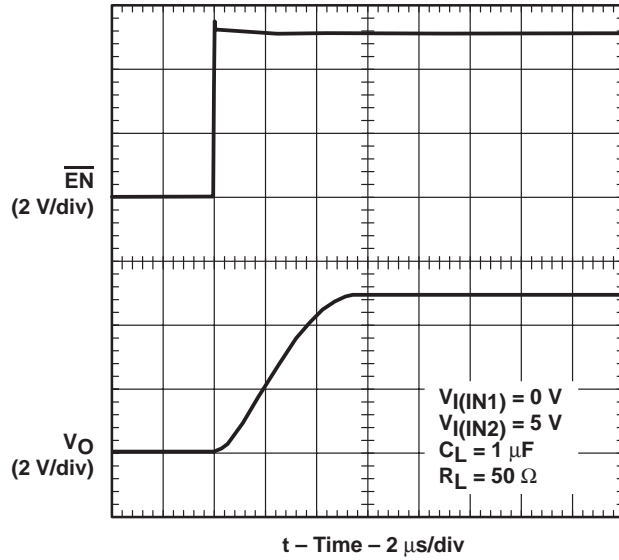

Figure 4. Propagation Delay and Rise Time With 1- μF Load, IN2 Turnon

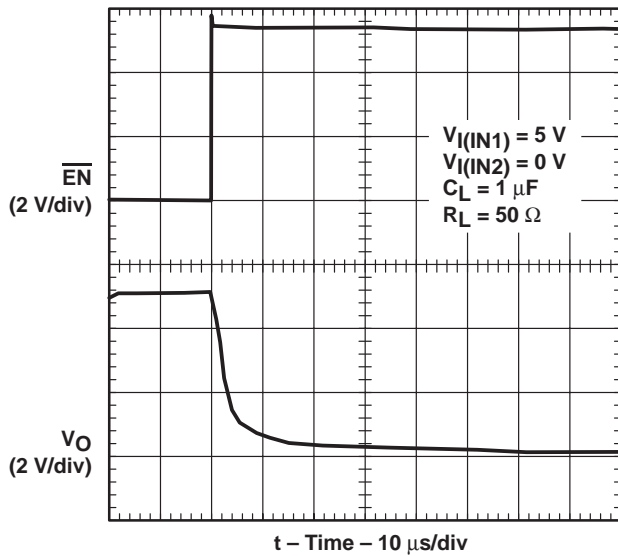

Figure 5. Propagation Delay and Fall Time With 1- μF Load, IN1 Turnoff

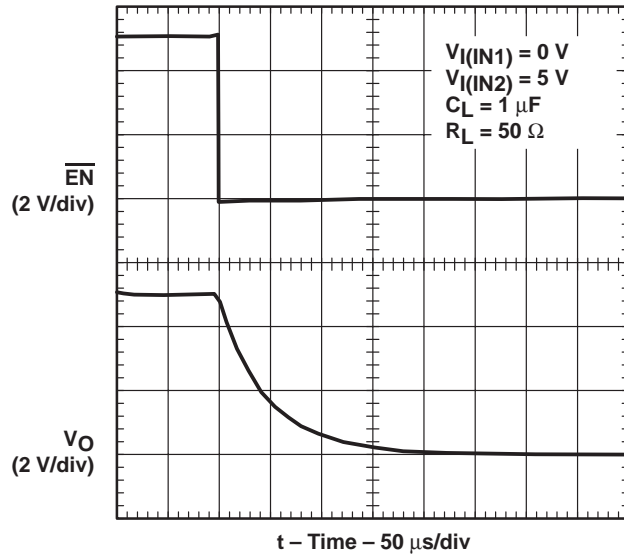

Figure 6. Propagation Delay and Fall Time With 1- μF Load, IN2 Turnoff

TYPICAL CHARACTERISTICS

Table of Graphs

		FIGURE
IN1 Switch Rise Time	vs Output Current	7
IN2 Switch Fall Time	vs Output Current	8
IN1 Switch Fall Time	vs Output Current	9
IN2 Switch Fall Time	vs Output Current	10
Output Voltage Droop	vs Output Current When Output Is Switched From IN2 to IN1	11
Inrush Current	vs Output Capacitance	12
IN1 Supply Current	vs Junction Temperature (IN1 Enabled)	13
IN1 Supply Current	vs Junction Temperature (IN1 Disabled)	14
IN2 Supply Current	vs Junction Temperature (IN2 Enabled)	15
IN2 Supply Current	vs Junction Temperature (IN2 Disabled)	16
IN1-OUT On-State Resistance	vs Junction Temperature	17
IN2-OUT On-State Resistance	vs Junction Temperature	18

IN1 SWITCH RISE TIME
 vs
 OUTPUT CURRENT

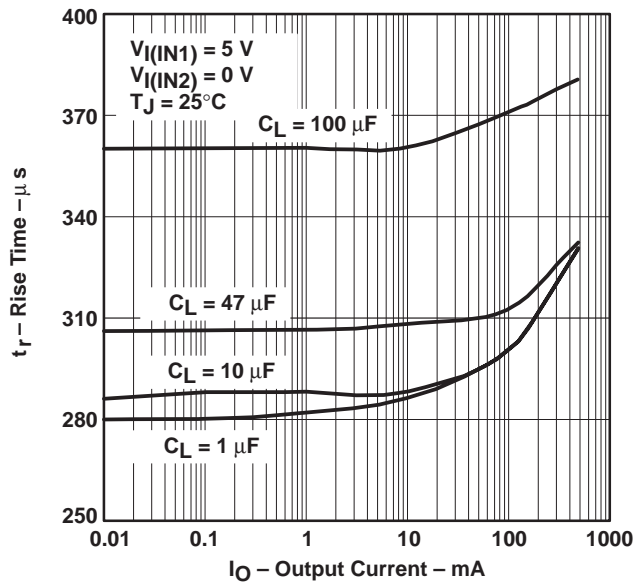

Figure 7

IN2 SWITCH RISE TIME
 vs
 OUTPUT CURRENT

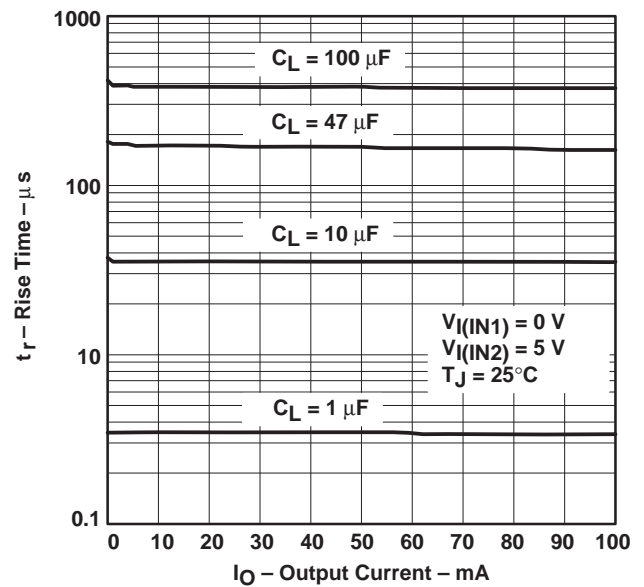

Figure 8

TYPICAL CHARACTERISTICS

**IN1 SWITCH FALL TIME
 vs
 OUTPUT CURRENT**

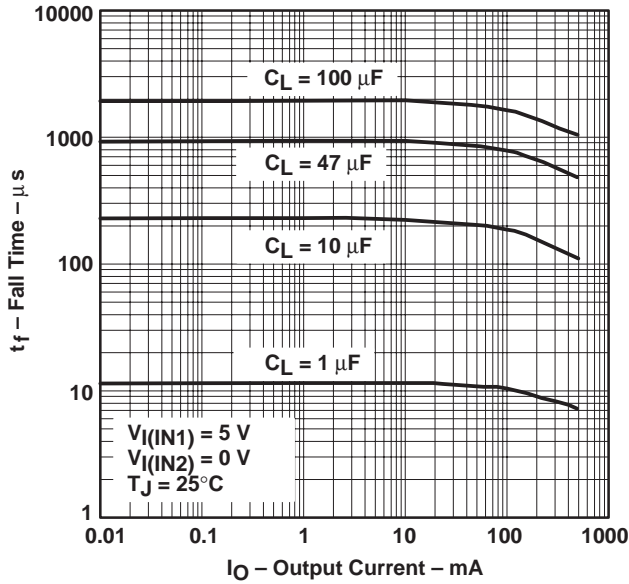

Figure 9

**IN2 SWITCH FALL TIME
 vs
 OUTPUT CURRENT**

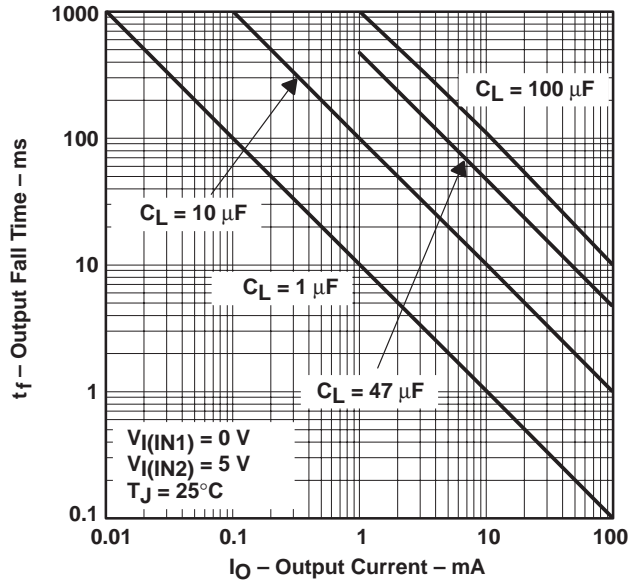

Figure 10

**OUTPUT VOLTAGE DROOP
 vs
 OUTPUT CURRENT WHEN OUTPUT
 IS SWITCHED FROM IN2 TO IN1†**

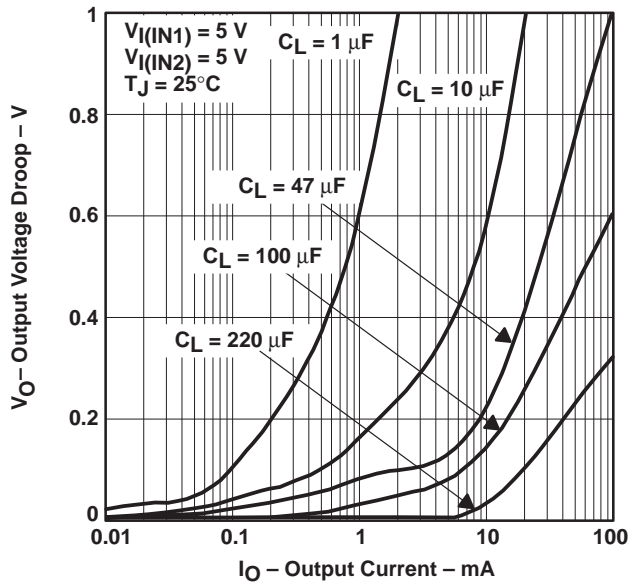

Figure 11

**INRUSH CURRENT
 vs
 OUTPUT CAPACITANCE**

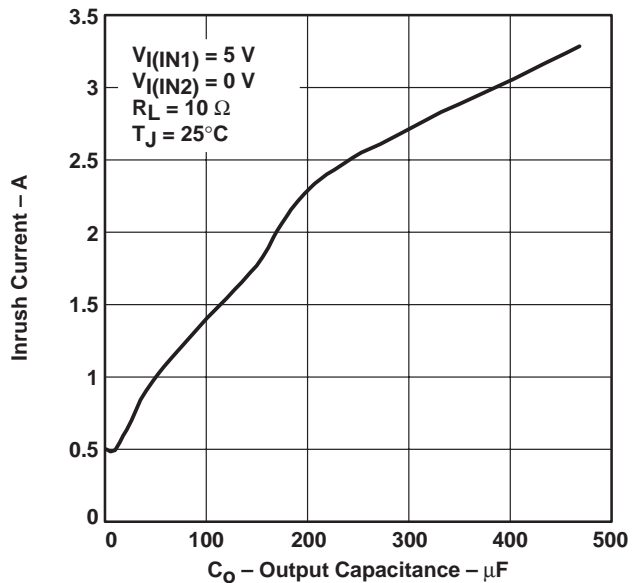

Figure 12

† If switching from IN1 to IN2, the voltage droop is much smaller. Therefore, the load capacitance should be chosen according to the curves in Figure 15.

TYPICAL CHARACTERISTICS

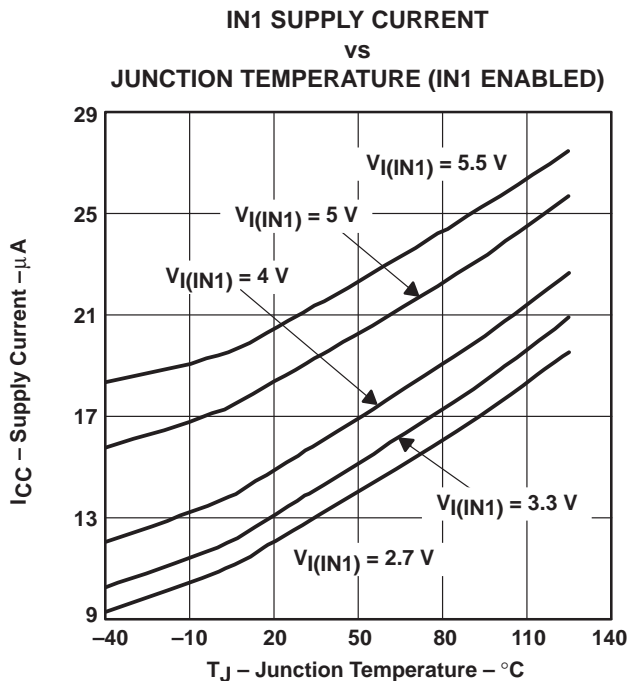

Figure 13

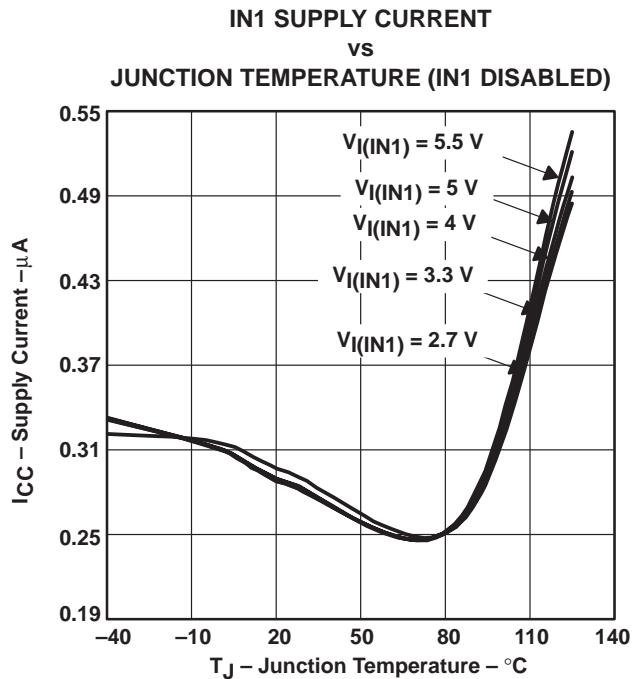

Figure 14

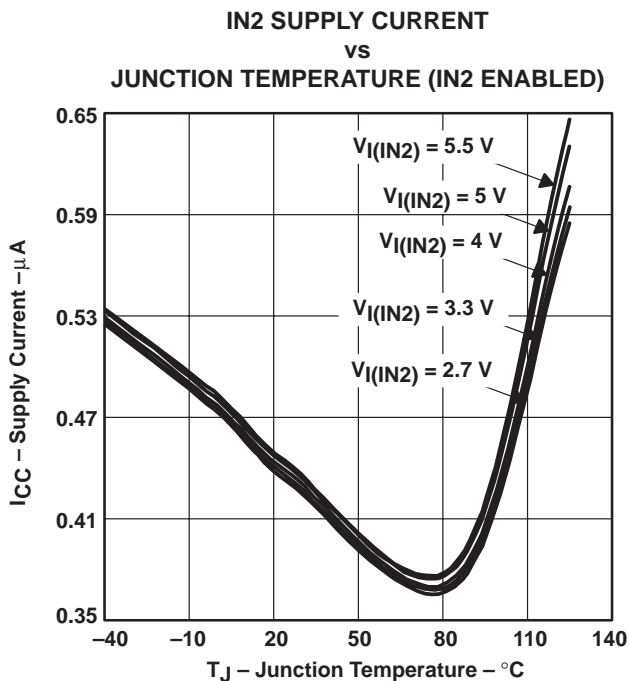

Figure 15

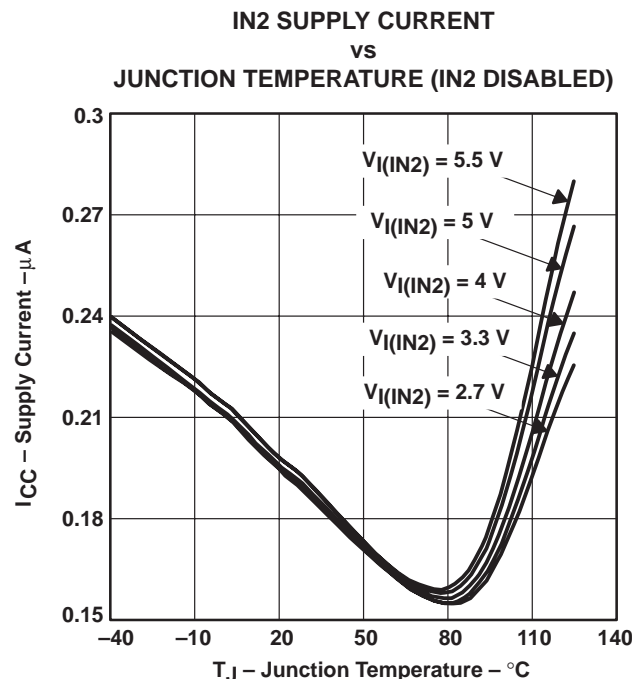

Figure 16

TYPICAL CHARACTERISTICS

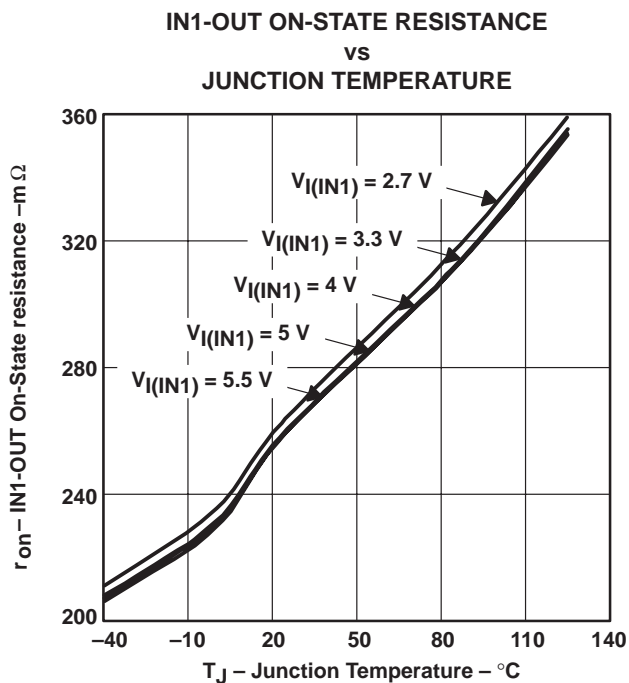

Figure 17

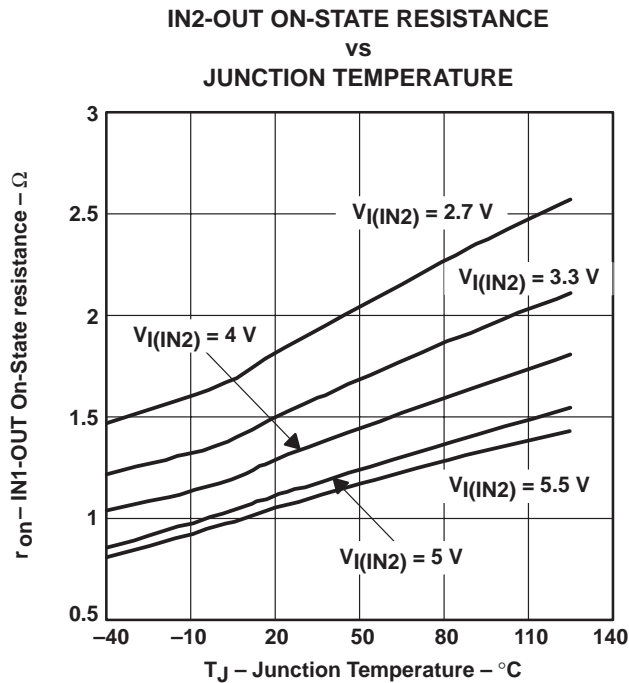

Figure 18

APPLICATION INFORMATION

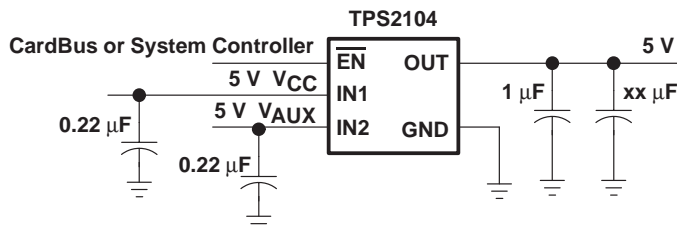

Figure 19. Typical Application

power-supply considerations

A 0.22-μF ceramic bypass capacitor between IN and GND, close to the device is recommended. The output capacitor should be chosen based on the size of the load during the transition of the switch. A 220-μF capacitor is recommended for 100-mA loads. Typical output capacitors (xx μF, shown in Figure 19) required for a given load can be determined from Figure 11 which shows the output voltage droop when output is switched from IN2 to IN1. The output voltage droop is insignificant when output is switched from IN1 to IN2. Additionally, bypassing the output with a 1-μF ceramic capacitor improves the immunity of the device to short-circuit transients.

APPLICATION INFORMATION

power supply considerations (continued)

switch transition

The n-channel MOSFET on IN1 uses a charge pump to create the gate-drive voltage, which gives the IN1 switch a rise time of approximately 0.4 ms. The p-channel MOSFET on IN2 has a simpler drive circuit that allows a rise time of approximately 4 μ s. Because the device has two switches and a single enable pin, these rise times are seen as transition times, from IN1 to IN2, or IN2 to IN1, by the output. The controlled transition times help limit the surge currents seen by the power supply during switching.

thermal protection

Thermal protection provided on the IN1 switch prevents damage to the IC when heavy-overload or short-circuit faults are present for extended periods of time. The increased dissipation causes the junction temperature to rise to dangerously high levels. The protection circuit senses the junction temperature of the switch and shuts it off at approximately 145°C (T_J). The switch remains off until the junction temperature has dropped approximately 10°C. The switch continues to cycle in this manner until the load fault or input power is removed.

undervoltage lockout

An undervoltage lockout function is provided to ensure that the power switch is in the off state at power up. Whenever the input voltage falls below approximately 2 V, the power switch quickly turns off. This function facilitates the design of hot-insertion systems that may not have the capability to turn off the power switch before input power is removed. Upon reinsertion, the power switch will be turned on with a controlled rise time to reduce EMI and voltage overshoots.

power dissipation and junction temperature

The low on-resistance on the n-channel MOSFET allows small surface-mount packages, such as SOIC, to pass large currents. The thermal resistances of these packages are high compared to those of power packages; it is good design practice to check power dissipation and junction temperature. First, find r_{on} at the input voltage and operating temperature. As an initial estimate, use the highest operating ambient temperature of interest and read r_{on} from Figure 17 or Figure 18. Next calculate the power dissipation using:

$$P_D = r_{on} \times I^2$$

Finally, calculate the junction temperature:

$$T_J = P_D \times R_{\theta JA} + T_A$$

Where:

T_A = Ambient temperature

$R_{\theta JA}$ = Thermal resistance

Compare the calculated junction temperature with the initial estimate. If they do not agree within a few degrees, repeat the calculation using the calculated value as the new estimate. Two or three iterations are generally sufficient to obtain a reasonable answer.

ESD protection

All TPS2104 and TPS2105 terminals incorporate ESD-protection circuitry designed to withstand a 2-kV human-body-model, 750-V CDM, and 200-V machine-model discharge as defined in MIL-STD-883C.

TPS2104, TPS2105 V_{AUX} POWER-DISTRIBUTION SWITCHES

SLVS235A – SEPTEMBER 1999 – REVISED APRIL 2000

MECHANICAL DATA

DBV (R-PDSO-G5)

PLASTIC SMALL-OUTLINE

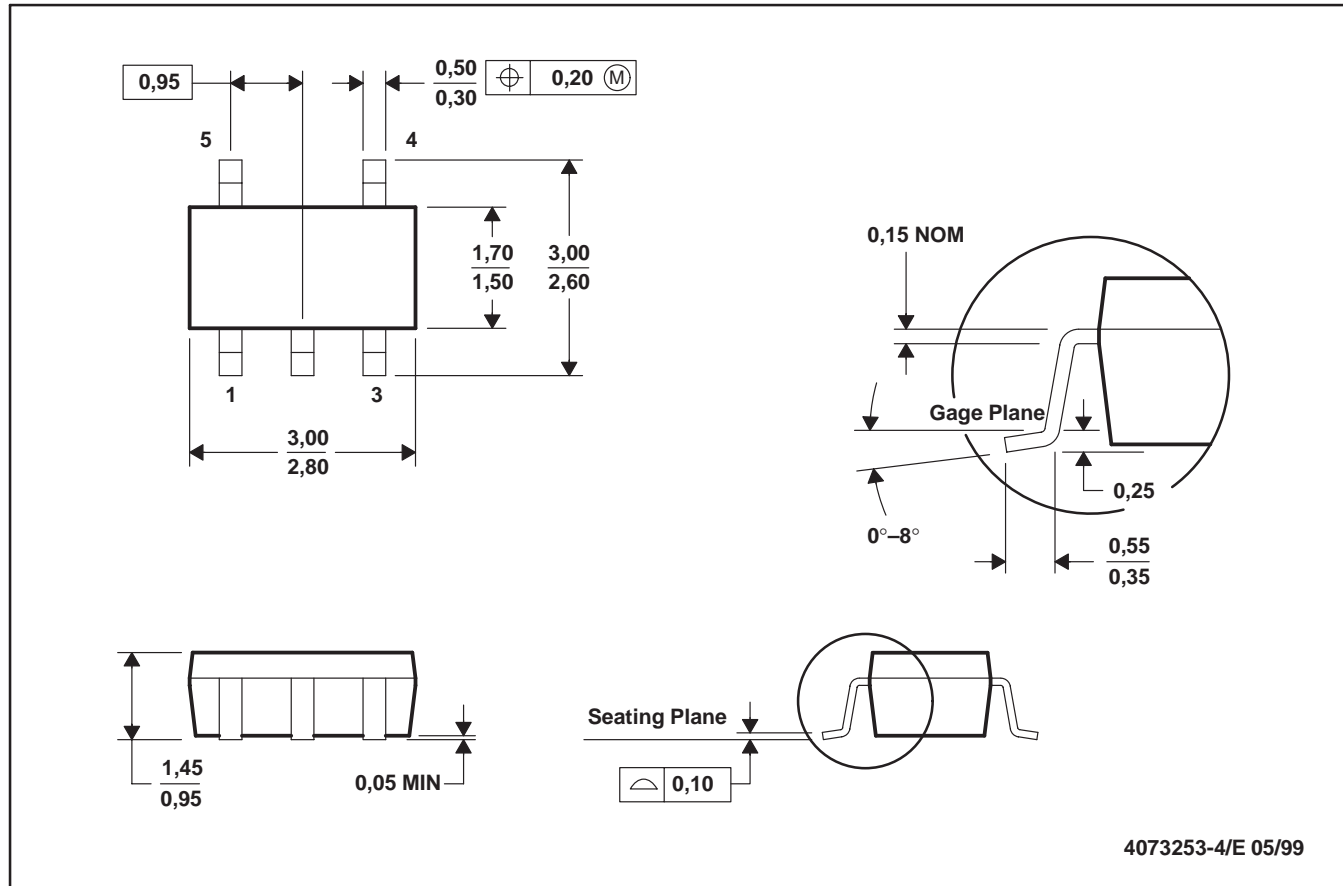

- NOTES:
- All linear dimensions are in millimeters.
 - This drawing is subject to change without notice.
 - Body dimensions do not include mold flash or protrusion.
 - Falls within JEDEC MO-178

MECHANICAL DATA

D (R-PDSO-G)**

PLASTIC SMALL-OUTLINE PACKAGE

14 PINS SHOWN

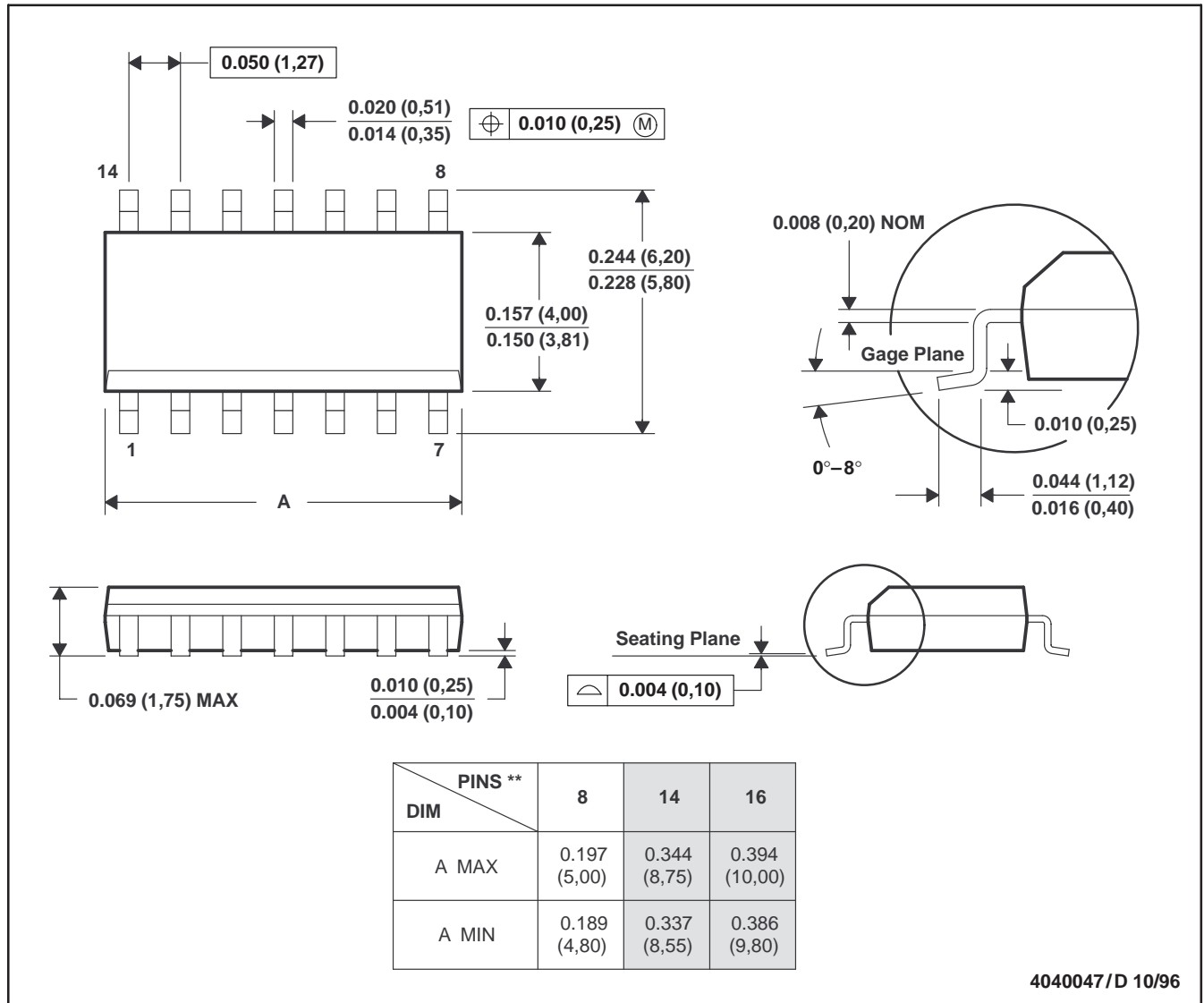

- NOTES: A. All linear dimensions are in inches (millimeters).
 B. This drawing is subject to change without notice.
 C. Body dimensions do not include mold flash or protrusion, not to exceed 0.006 (0,15).
 D. Falls within JEDEC MS-012

PACKAGING INFORMATION

Orderable Device	Status ⁽¹⁾	Package Type	Package Drawing	Pins	Package Qty	Eco Plan ⁽²⁾	Lead/Ball Finish	MSL Peak Temp ⁽³⁾
TPS2104DBVR	ACTIVE	SOT-23	DBV	5	3000	Green (RoHS & no Sb/Br)	CU NIPDAU	Level-1-260C-UNLIM
TPS2104DBVRG4	ACTIVE	SOT-23	DBV	5	3000	Green (RoHS & no Sb/Br)	CU NIPDAU	Level-1-260C-UNLIM
TPS2104DBVT	ACTIVE	SOT-23	DBV	5	250	Green (RoHS & no Sb/Br)	CU NIPDAU	Level-1-260C-UNLIM
TPS2104DBVTG4	ACTIVE	SOT-23	DBV	5	250	Green (RoHS & no Sb/Br)	CU NIPDAU	Level-1-260C-UNLIM
TPS2105D	ACTIVE	SOIC	D	8	75	Green (RoHS & no Sb/Br)	CU NIPDAU	Level-1-260C-UNLIM
TPS2105DBVR	ACTIVE	SOT-23	DBV	5	3000	Green (RoHS & no Sb/Br)	CU NIPDAU	Level-1-260C-UNLIM
TPS2105DBVRG4	ACTIVE	SOT-23	DBV	5	3000	Green (RoHS & no Sb/Br)	CU NIPDAU	Level-1-260C-UNLIM
TPS2105DBVT	ACTIVE	SOT-23	DBV	5	250	Green (RoHS & no Sb/Br)	CU NIPDAU	Level-1-260C-UNLIM
TPS2105DBVTG4	ACTIVE	SOT-23	DBV	5	250	Green (RoHS & no Sb/Br)	CU NIPDAU	Level-1-260C-UNLIM
TPS2105DG4	ACTIVE	SOIC	D	8	75	Green (RoHS & no Sb/Br)	CU NIPDAU	Level-1-260C-UNLIM

⁽¹⁾ The marketing status values are defined as follows:

ACTIVE: Product device recommended for new designs.

LIFEBUY: TI has announced that the device will be discontinued, and a lifetime-buy period is in effect.

NRND: Not recommended for new designs. Device is in production to support existing customers, but TI does not recommend using this part in a new design.

PREVIEW: Device has been announced but is not in production. Samples may or may not be available.

OBsolete: TI has discontinued the production of the device.

⁽²⁾ Eco Plan - The planned eco-friendly classification: Pb-Free (RoHS), Pb-Free (RoHS Exempt), or Green (RoHS & no Sb/Br) - please check <http://www.ti.com/productcontent> for the latest availability information and additional product content details.

TBD: The Pb-Free/Green conversion plan has not been defined.

Pb-Free (RoHS): TI's terms "Lead-Free" or "Pb-Free" mean semiconductor products that are compatible with the current RoHS requirements for all 6 substances, including the requirement that lead not exceed 0.1% by weight in homogeneous materials. Where designed to be soldered at high temperatures, TI Pb-Free products are suitable for use in specified lead-free processes.

Pb-Free (RoHS Exempt): This component has a RoHS exemption for either 1) lead-based flip-chip solder bumps used between the die and package, or 2) lead-based die adhesive used between the die and leadframe. The component is otherwise considered Pb-Free (RoHS compatible) as defined above.

Green (RoHS & no Sb/Br): TI defines "Green" to mean Pb-Free (RoHS compatible), and free of Bromine (Br) and Antimony (Sb) based flame retardants (Br or Sb do not exceed 0.1% by weight in homogeneous material)

⁽³⁾ MSL, Peak Temp. -- The Moisture Sensitivity Level rating according to the JEDEC industry standard classifications, and peak solder temperature.

Important Information and Disclaimer: The information provided on this page represents TI's knowledge and belief as of the date that it is provided. TI bases its knowledge and belief on information provided by third parties, and makes no representation or warranty as to the accuracy of such information. Efforts are underway to better integrate information from third parties. TI has taken and continues to take reasonable steps to provide representative and accurate information but may not have conducted destructive testing or chemical analysis on incoming materials and chemicals. TI and TI suppliers consider certain information to be proprietary, and thus CAS numbers and other limited information may not be available for release.

In no event shall TI's liability arising out of such information exceed the total purchase price of the TI part(s) at issue in this document sold by TI to Customer on an annual basis.

TAPE AND REEL INFORMATION



QUADRANT ASSIGNMENTS FOR PIN 1 ORIENTATION IN TAPE



*All dimensions are nominal

Device	Package Type	Package Drawing	Pins	SPQ	Reel Diameter (mm)	Reel Width W1 (mm)	A0 (mm)	B0 (mm)	K0 (mm)	P1 (mm)	W (mm)	Pin1 Quadrant
TPS2104DBVR	SOT-23	DBV	5	3000	180.0	9.0	3.15	3.2	1.4	4.0	8.0	Q3
TPS2104DBVT	SOT-23	DBV	5	250	180.0	9.0	3.15	3.2	1.4	4.0	8.0	Q3
TPS2105DBVR	SOT-23	DBV	5	3000	180.0	9.0	3.15	3.2	1.4	4.0	8.0	Q3
TPS2105DBVT	SOT-23	DBV	5	250	180.0	9.0	3.15	3.2	1.4	4.0	8.0	Q3

TAPE AND REEL BOX DIMENSIONS



*All dimensions are nominal

Device	Package Type	Package Drawing	Pins	SPQ	Length (mm)	Width (mm)	Height (mm)
TPS2104DBVR	SOT-23	DBV	5	3000	182.0	182.0	20.0
TPS2104DBVT	SOT-23	DBV	5	250	182.0	182.0	20.0
TPS2105DBVR	SOT-23	DBV	5	3000	182.0	182.0	20.0
TPS2105DBVT	SOT-23	DBV	5	250	182.0	182.0	20.0

IMPORTANT NOTICE

Texas Instruments Incorporated and its subsidiaries (TI) reserve the right to make corrections, modifications, enhancements, improvements, and other changes to its products and services at any time and to discontinue any product or service without notice. Customers should obtain the latest relevant information before placing orders and should verify that such information is current and complete. All products are sold subject to TI's terms and conditions of sale supplied at the time of order acknowledgment.

TI warrants performance of its hardware products to the specifications applicable at the time of sale in accordance with TI's standard warranty. Testing and other quality control techniques are used to the extent TI deems necessary to support this warranty. Except where mandated by government requirements, testing of all parameters of each product is not necessarily performed.

TI assumes no liability for applications assistance or customer product design. Customers are responsible for their products and applications using TI components. To minimize the risks associated with customer products and applications, customers should provide adequate design and operating safeguards.

TI does not warrant or represent that any license, either express or implied, is granted under any TI patent right, copyright, mask work right, or other TI intellectual property right relating to any combination, machine, or process in which TI products or services are used. Information published by TI regarding third-party products or services does not constitute a license from TI to use such products or services or a warranty or endorsement thereof. Use of such information may require a license from a third party under the patents or other intellectual property of the third party, or a license from TI under the patents or other intellectual property of TI.

Reproduction of TI information in TI data books or data sheets is permissible only if reproduction is without alteration and is accompanied by all associated warranties, conditions, limitations, and notices. Reproduction of this information with alteration is an unfair and deceptive business practice. TI is not responsible or liable for such altered documentation. Information of third parties may be subject to additional restrictions.

Resale of TI products or services with statements different from or beyond the parameters stated by TI for that product or service voids all express and any implied warranties for the associated TI product or service and is an unfair and deceptive business practice. TI is not responsible or liable for any such statements.

TI products are not authorized for use in safety-critical applications (such as life support) where a failure of the TI product would reasonably be expected to cause severe personal injury or death, unless officers of the parties have executed an agreement specifically governing such use. Buyers represent that they have all necessary expertise in the safety and regulatory ramifications of their applications, and acknowledge and agree that they are solely responsible for all legal, regulatory and safety-related requirements concerning their products and any use of TI products in such safety-critical applications, notwithstanding any applications-related information or support that may be provided by TI. Further, Buyers must fully indemnify TI and its representatives against any damages arising out of the use of TI products in such safety-critical applications.

TI products are neither designed nor intended for use in military/aerospace applications or environments unless the TI products are specifically designated by TI as military-grade or "enhanced plastic." Only products designated by TI as military-grade meet military specifications. Buyers acknowledge and agree that any such use of TI products which TI has not designated as military-grade is solely at the Buyer's risk, and that they are solely responsible for compliance with all legal and regulatory requirements in connection with such use.

TI products are neither designed nor intended for use in automotive applications or environments unless the specific TI products are designated by TI as compliant with ISO/TS 16949 requirements. Buyers acknowledge and agree that, if they use any non-designated products in automotive applications, TI will not be responsible for any failure to meet such requirements.

Following are URLs where you can obtain information on other Texas Instruments products and application solutions:

Products

Amplifiers	amplifier.ti.com
Data Converters	dataconverter.ti.com
DSP	dsp.ti.com
Clocks and Timers	www.ti.com/clocks
Interface	interface.ti.com
Logic	logic.ti.com
Power Mgmt	power.ti.com
Microcontrollers	microcontroller.ti.com
RFID	www.ti-rfid.com
RF/IF and ZigBee® Solutions	www.ti.com/lprf

Applications

Audio	www.ti.com/audio
Automotive	www.ti.com/automotive
Broadband	www.ti.com/broadband
Digital Control	www.ti.com/digitalcontrol
Medical	www.ti.com/medical
Military	www.ti.com/military
Optical Networking	www.ti.com/opticalnetwork
Security	www.ti.com/security
Telephony	www.ti.com/telephony
Video & Imaging	www.ti.com/video
Wireless	www.ti.com/wireless

Mailing Address: Texas Instruments, Post Office Box 655303, Dallas, Texas 75265
Copyright © 2008, Texas Instruments Incorporated



Стандарт Электрон Связь

Мы молодая и активно развивающаяся компания в области поставок электронных компонентов. Мы поставляем электронные компоненты отечественного и импортного производства напрямую от производителей и с крупнейших складов мира.

Благодаря сотрудничеству с мировыми поставщиками мы осуществляем комплексные и плановые поставки широчайшего спектра электронных компонентов.

Собственная эффективная логистика и склад в обеспечивает надежную поставку продукции в точно указанные сроки по всей России.

Мы осуществляем техническую поддержку нашим клиентам и предпродажную проверку качества продукции. На все поставляемые продукты мы предоставляем гарантию .

Осуществляем поставки продукции под контролем ВП МО РФ на предприятия военно-промышленного комплекса России , а также работаем в рамках 275 ФЗ с открытием отдельных счетов в уполномоченном банке. Система менеджмента качества компании соответствует требованиям ГОСТ ISO 9001.

Минимальные сроки поставки, гибкие цены, неограниченный ассортимент и индивидуальный подход к клиентам являются основой для выстраивания долгосрочного и эффективного сотрудничества с предприятиями радиоэлектронной промышленности, предприятиями ВПК и научно-исследовательскими институтами России.

С нами вы становитесь еще успешнее!

Наши контакты:

Телефон: +7 812 627 14 35

Электронная почта: sales@st-electron.ru

Адрес: 198099, Санкт-Петербург,
Промышленная ул, дом № 19, литера Н,
помещение 100-Н Офис 331