

DATA SHEET

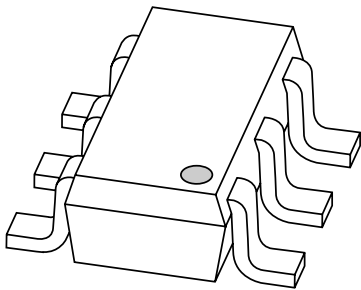

BC817DPN NPN/PNP general purpose transistor

Product data sheet
Supersedes data of 2002 Aug 09

2002 Nov 22

NPN/PNP general purpose transistor

BC817DPN

FEATURES

- High current (500 mA)
- 600 mW total power dissipation
- Replaces two SOT23 packaged transistors on same PCB area.

APPLICATIONS

- General purpose switching and amplification
- Complementary driver
- Half and full bridge driver.

DESCRIPTION

NPN/PNP transistor pair in a SOT457 (SC-74) plastic package.

MARKING

TYPE NUMBER	MARKING CODE
BC817DPN	N4

QUICK REFERENCE DATA

SYMBOL	PARAMETER	MAX.	UNIT
V_{CE0}	collector-emitter voltage	45	V
I_C	collector current (DC)	500	mA
I_{CM}	peak collector current	1	A

PINNING

PIN	DESCRIPTION
1, 4	emitter TR1; TR2
2, 5	base TR1; TR2
6, 3	collector TR1; TR2

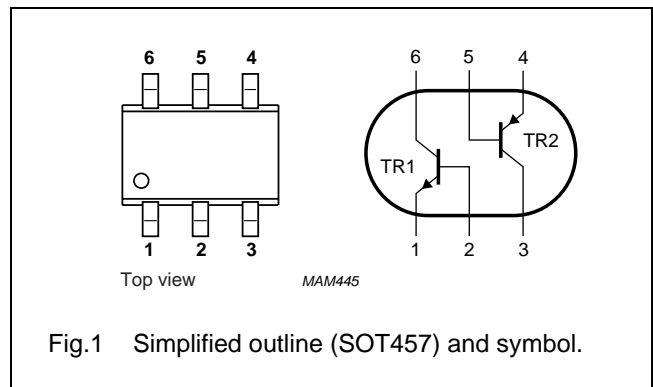

LIMITING VALUES

In accordance with the Absolute Maximum Rating System (IEC 60134).

SYMBOL	PARAMETER	CONDITIONS	MIN.	MAX.	UNIT
Per transistor; for the PNP transistor with negative polarity					
V_{CB0}	collector-base voltage	open emitter	–	50	V
V_{CE0}	collector-emitter voltage	open base	–	45	V
V_{EB0}	emitter-base voltage	open collector	–	5	V
I_C	collector current (DC)		–	500	mA
I_{CM}	peak collector current		–	1	A
I_{BM}	peak base current		–	200	mA
P_{tot}	total power dissipation	$T_{amb} \leq 25\text{ °C}$; note 1	–	370	mW
T_{stg}	storage temperature		–65	+150	°C
T_j	junction temperature		–	150	°C
T_{amb}	operating ambient temperature		–65	+150	°C
Per device					
P_{tot}	total power dissipation	$T_{amb} \leq 25\text{ °C}$; note 1	–	600	mW

Note

1. Device mounted on a printed-circuit board; single sided copper; tinplated; mounting pad for collector 1 cm².

NPN/PNP general purpose transistor

BC817DPN

THERMAL CHARACTERISTICS

SYMBOL	PARAMETER	CONDITIONS	VALUE	UNIT
$R_{th\ j-a}$	thermal resistance from junction to ambient	note 1	208	K/W

Note

1. Device mounted on a printed-circuit board; single sided copper; tinplated; mounting pad for collector 1 cm².

CHARACTERISTICS

$T_{amb} = 25\text{ °C}$ unless otherwise specified.

SYMBOL	PARAMETER	CONDITIONS	MIN.	TYP.	MAX.	UNIT
Per transistor unless otherwise specified; for the PNP transistor with negative polarity						
I_{CBO}	collector-base cut-off current	$V_{CB} = 20\text{ V}; I_E = 0$	–	–	100	nA
		$V_{CB} = 20\text{ V}; I_E = 0; T_j = 150\text{ °C}$	–	–	5	μA
I_{EBO}	emitter-base cut-off current	$V_{EB} = 5\text{ V}; I_C = 0$	–	–	100	nA
h_{FE}	DC current gain	$V_{CE} = 1\text{ V}; I_C = 100\text{ mA};$ note 1	160	–	400	
		$V_{CE} = 1\text{ V}; I_C = 500\text{ mA};$ note 1	40	–	–	
V_{CEsat}	collector-emitter saturation voltage	$I_C = 500\text{ mA}; I_B = 50\text{ mA};$ note 1	–	–	700	mV
V_{BE}	base-emitter voltage	$V_{CE} = 1\text{ V}; I_C = 500\text{ mA};$ notes 1 and 2	–	–	1.2	V
NPN transistor						
C_c	collector capacitance	$V_{CB} = 10\text{ V}; I_E = I_e = 0; f = 1\text{ MHz}$	–	5	–	pF
f_T	transition frequency	$V_{CE} = 5\text{ V}; I_C = 10\text{ mA};$ $f = 100\text{ MHz}$	100	–	–	MHz
PNP transistor						
C_c	collector capacitance	$V_{CB} = -10\text{ V}; I_E = I_e = 0; f = 1\text{ MHz}$	–	9	–	pF
f_T	transition frequency	$V_{CE} = -5\text{ V}; I_C = -10\text{ mA};$ $f = 100\text{ MHz}$	80	–	–	MHz

Notes

1. Pulse test: $t_p \leq 300\text{ μs}; \delta \leq 0.02$.
2. V_{BE} decreases by approximately -2 mV/K with increasing temperature.

NPN/PNP general purpose transistor

BC817DPN

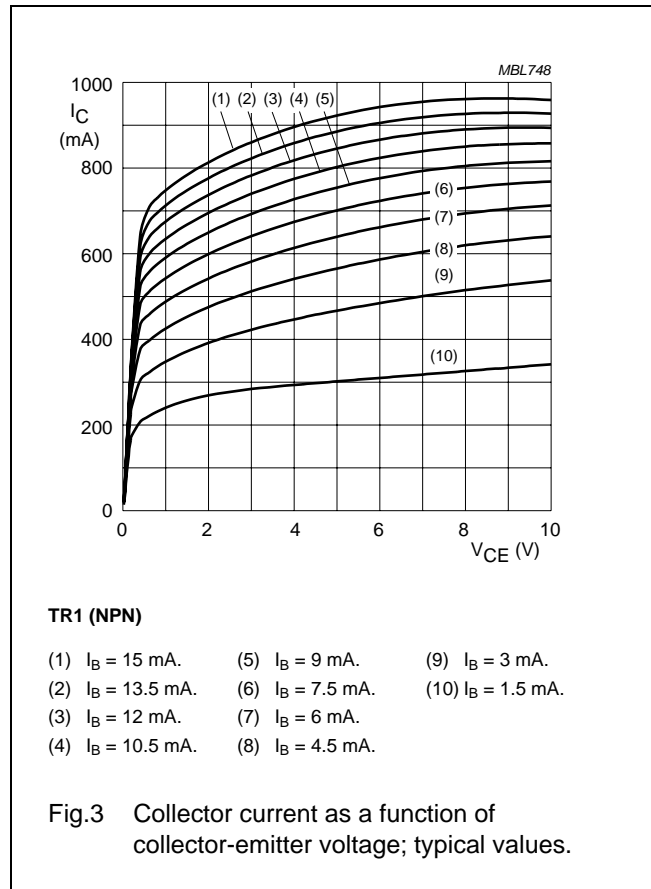
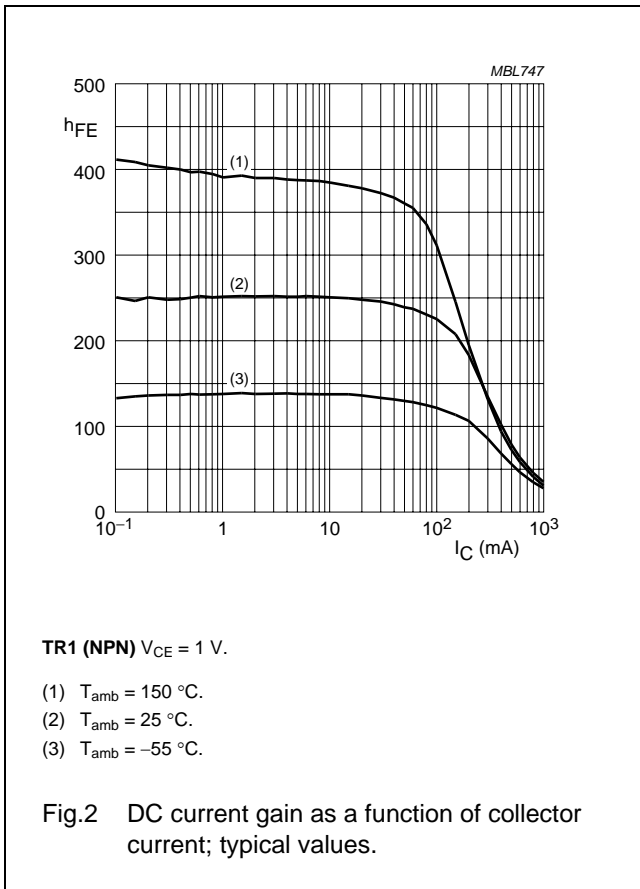

NPN/PNP general purpose transistor

BC817DPN

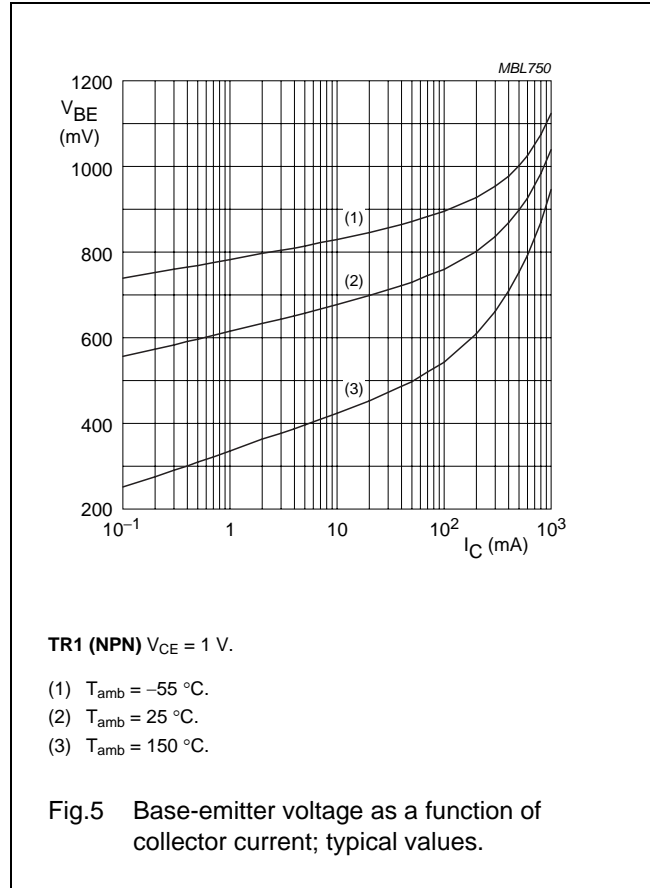
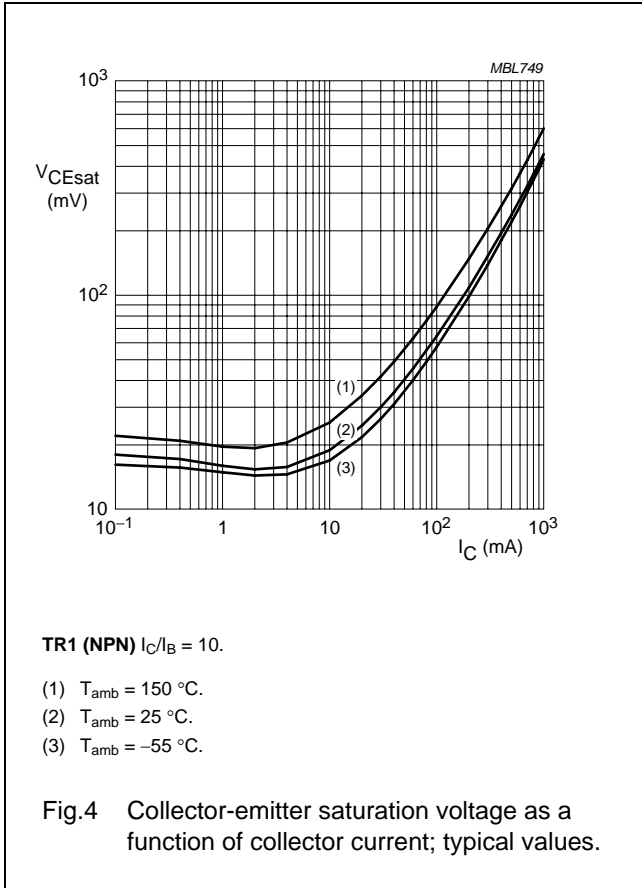

NPN/PNP general purpose transistor

BC817DPN

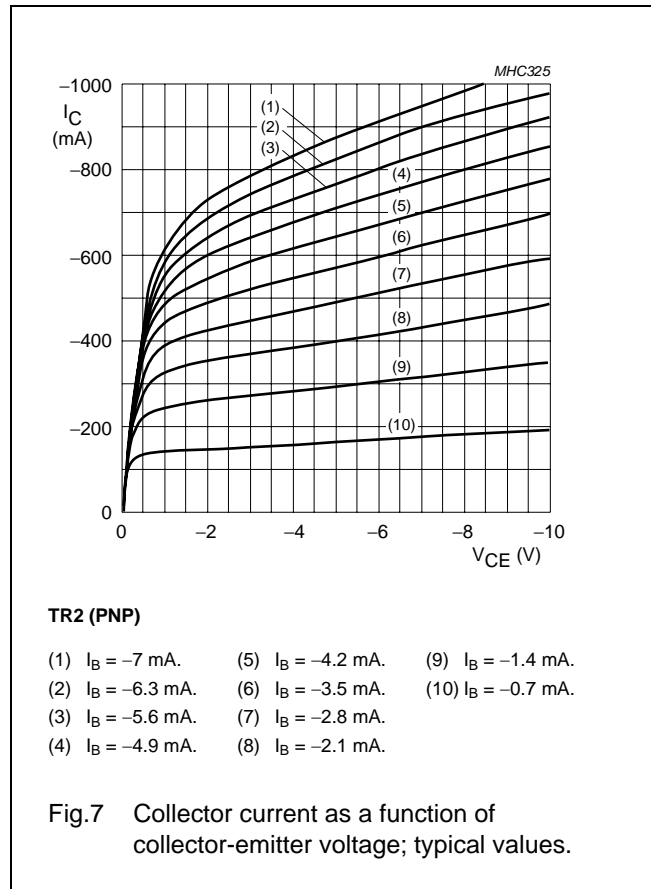
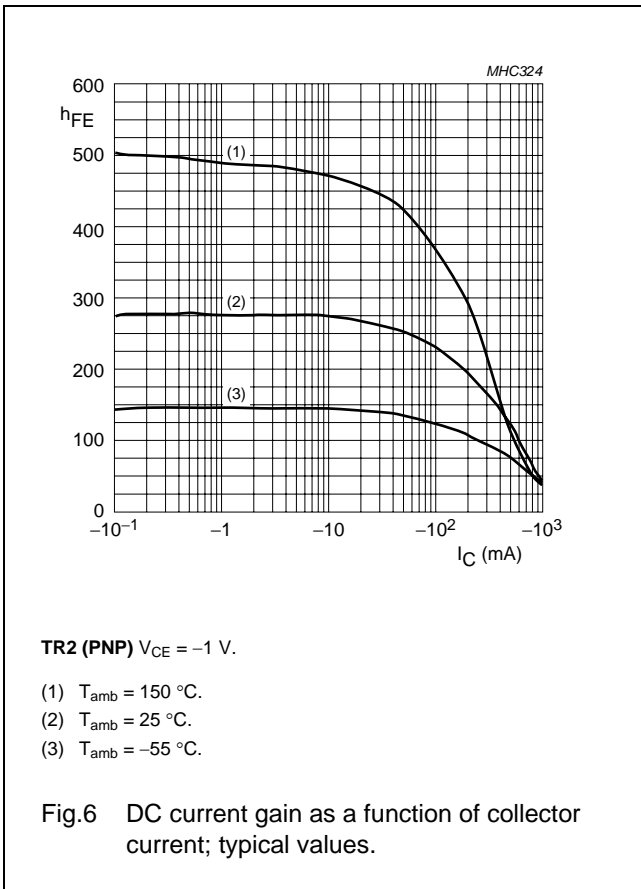

NPN/PNP general purpose transistor

BC817DPN

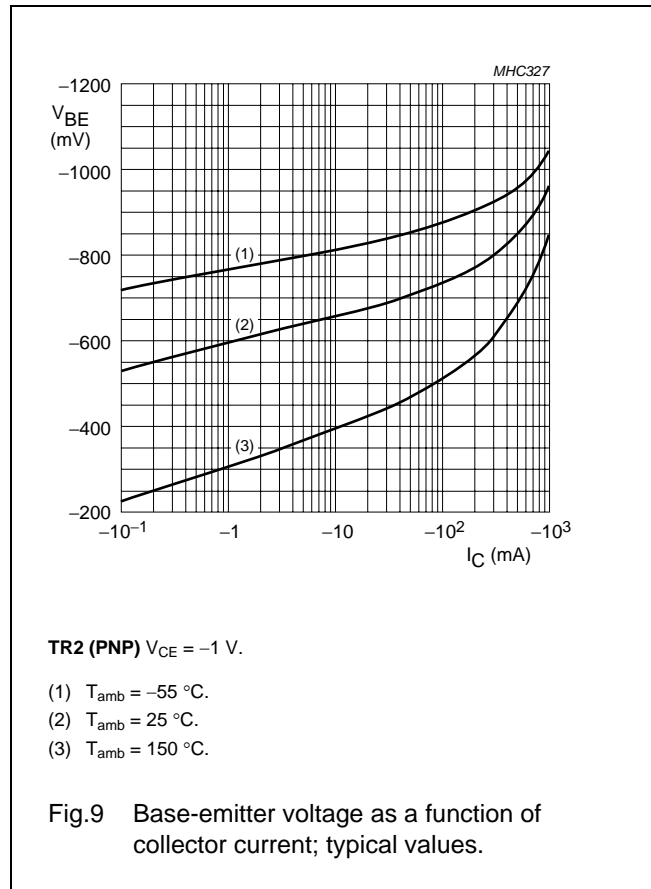
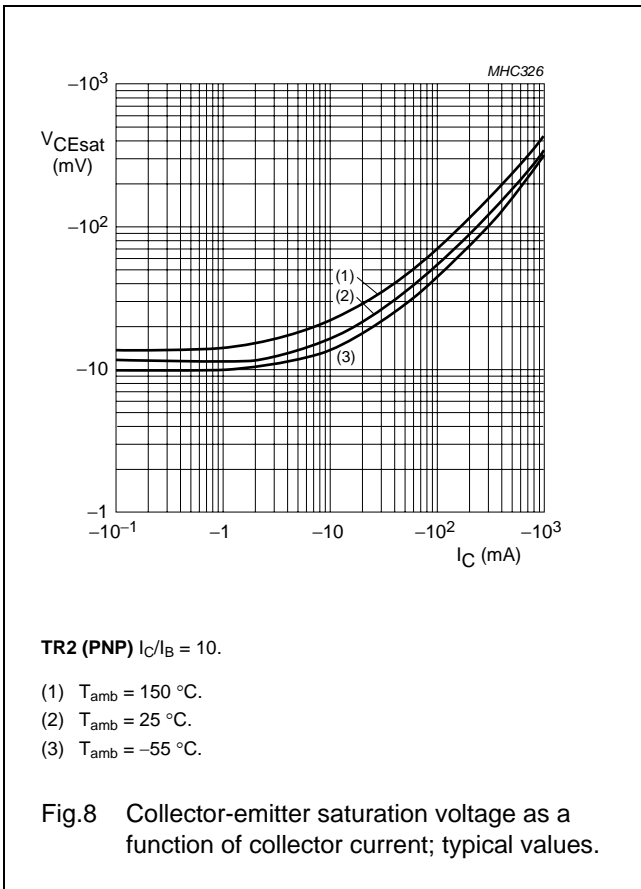

NPN/PNP general purpose transistor

BC817DPN

PACKAGE OUTLINE

Plastic surface mounted package; 6 leads

SOT457

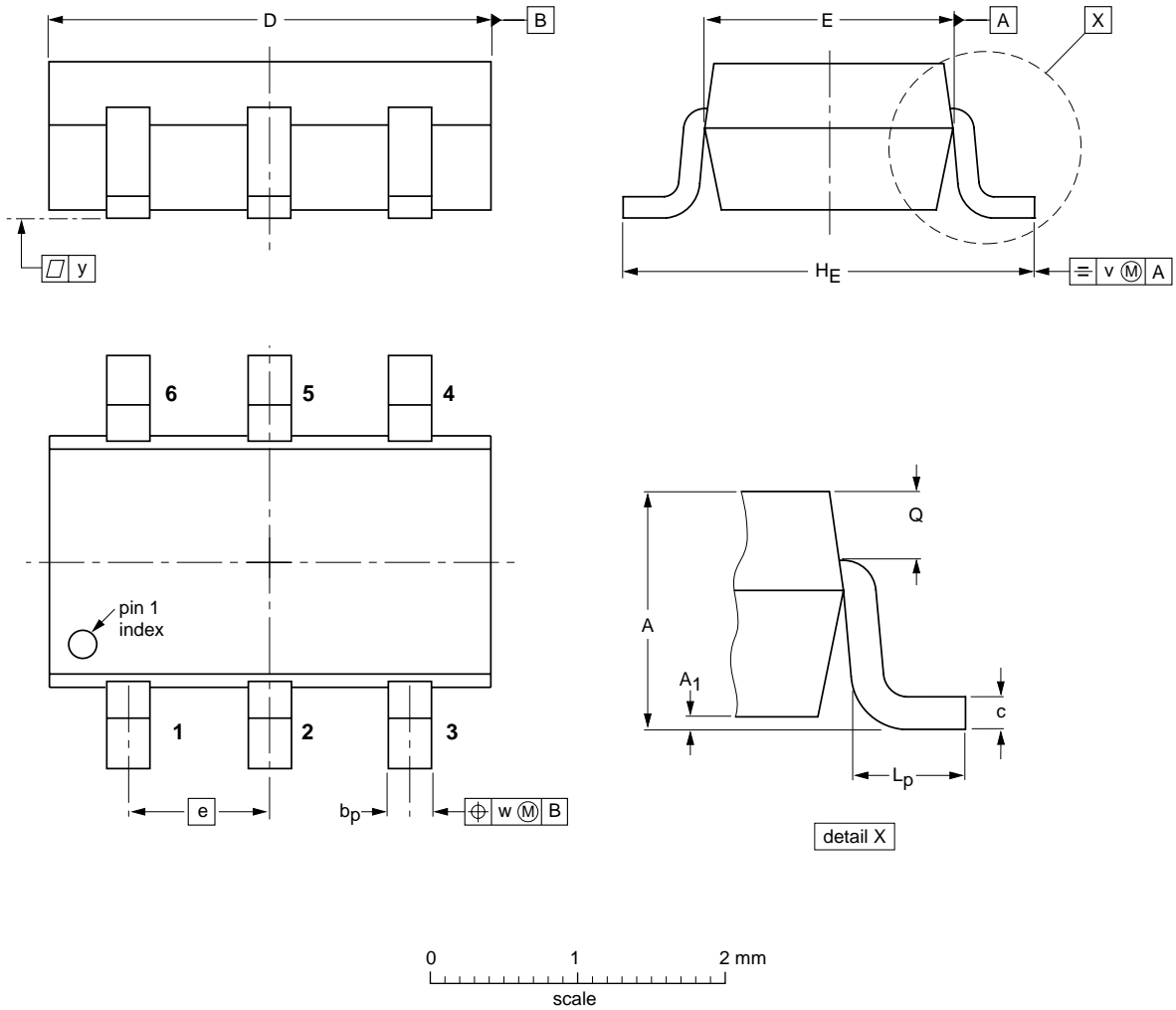

DIMENSIONS (mm are the original dimensions)

UNIT	A	A ₁	b _p	c	D	E	e	H _E	L _p	Q	v	w	y
mm	1.1 0.9	0.1 0.013	0.40 0.25	0.26 0.10	3.1 2.7	1.7 1.3	0.95	3.0 2.5	0.6 0.2	0.33 0.23	0.2	0.2	0.1

OUTLINE VERSION	REFERENCES				EUROPEAN PROJECTION	ISSUE DATE
	IEC	JEDEC	EIAJ			
SOT457			SC-74			97-02-28-01-05-04

NPN/PNP general purpose transistor

BC817DPN

DATA SHEET STATUS

DOCUMENT STATUS ⁽¹⁾	PRODUCT STATUS ⁽²⁾	DEFINITION
Objective data sheet	Development	This document contains data from the objective specification for product development.
Preliminary data sheet	Qualification	This document contains data from the preliminary specification.
Product data sheet	Production	This document contains the product specification.

Notes

1. Please consult the most recently issued document before initiating or completing a design.
2. The product status of device(s) described in this document may have changed since this document was published and may differ in case of multiple devices. The latest product status information is available on the Internet at URL <http://www.nxp.com>.

DISCLAIMERS

General — Information in this document is believed to be accurate and reliable. However, NXP Semiconductors does not give any representations or warranties, expressed or implied, as to the accuracy or completeness of such information and shall have no liability for the consequences of use of such information.

Right to make changes — NXP Semiconductors reserves the right to make changes to information published in this document, including without limitation specifications and product descriptions, at any time and without notice. This document supersedes and replaces all information supplied prior to the publication hereof.

Suitability for use — NXP Semiconductors products are not designed, authorized or warranted to be suitable for use in medical, military, aircraft, space or life support equipment, nor in applications where failure or malfunction of an NXP Semiconductors product can reasonably be expected to result in personal injury, death or severe property or environmental damage. NXP Semiconductors accepts no liability for inclusion and/or use of NXP Semiconductors products in such equipment or applications and therefore such inclusion and/or use is at the customer's own risk.

Applications — Applications that are described herein for any of these products are for illustrative purposes only. NXP Semiconductors makes no representation or warranty that such applications will be suitable for the specified use without further testing or modification.

Limiting values — Stress above one or more limiting values (as defined in the Absolute Maximum Ratings

System of IEC 60134) may cause permanent damage to the device. Limiting values are stress ratings only and operation of the device at these or any other conditions above those given in the Characteristics sections of this document is not implied. Exposure to limiting values for extended periods may affect device reliability.

Terms and conditions of sale — NXP Semiconductors products are sold subject to the general terms and conditions of commercial sale, as published at <http://www.nxp.com/profile/terms>, including those pertaining to warranty, intellectual property rights infringement and limitation of liability, unless explicitly otherwise agreed to in writing by NXP Semiconductors. In case of any inconsistency or conflict between information in this document and such terms and conditions, the latter will prevail.

No offer to sell or license — Nothing in this document may be interpreted or construed as an offer to sell products that is open for acceptance or the grant, conveyance or implication of any license under any copyrights, patents or other industrial or intellectual property rights.

Export control — This document as well as the item(s) described herein may be subject to export control regulations. Export might require a prior authorization from national authorities.

Quick reference data — The Quick reference data is an extract of the product data given in the Limiting values and Characteristics sections of this document, and as such is not complete, exhaustive or legally binding.

NXP Semiconductors

Customer notification

This data sheet was changed to reflect the new company name NXP Semiconductors. No changes were made to the content, except for the legal definitions and disclaimers.

Contact information

For additional information please visit: **<http://www.nxp.com>**

For sales offices addresses send e-mail to: **salesaddresses@nxp.com**

© NXP B.V. 2009

All rights are reserved. Reproduction in whole or in part is prohibited without the prior written consent of the copyright owner.

The information presented in this document does not form part of any quotation or contract, is believed to be accurate and reliable and may be changed without notice. No liability will be accepted by the publisher for any consequence of its use. Publication thereof does not convey nor imply any license under patent- or other industrial or intellectual property rights.

Printed in The Netherlands

613514/02/pp10

Date of release: 2002 Nov 22

Document order number: 9397 750 10583





**Стандарт
Электрон
Связь**

Мы молодая и активно развивающаяся компания в области поставок электронных компонентов. Мы поставляем электронные компоненты отечественного и импортного производства напрямую от производителей и с крупнейших складов мира.

Благодаря сотрудничеству с мировыми поставщиками мы осуществляем комплексные и плановые поставки широчайшего спектра электронных компонентов.

Собственная эффективная логистика и склад в обеспечивает надежную поставку продукции в точно указанные сроки по всей России.

Мы осуществляем техническую поддержку нашим клиентам и предпродажную проверку качества продукции. На все поставляемые продукты мы предоставляем гарантию .

Осуществляем поставки продукции под контролем ВП МО РФ на предприятия военно-промышленного комплекса России , а также работаем в рамках 275 ФЗ с открытием отдельных счетов в уполномоченном банке. Система менеджмента качества компании соответствует требованиям ГОСТ ISO 9001.

Минимальные сроки поставки, гибкие цены, неограниченный ассортимент и индивидуальный подход к клиентам являются основой для выстраивания долгосрочного и эффективного сотрудничества с предприятиями радиоэлектронной промышленности, предприятиями ВПК и научно-исследовательскими институтами России.

С нами вы становитесь еще успешнее!

Наши контакты:

Телефон: +7 812 627 14 35

Электронная почта: sales@st-electron.ru

Адрес: 198099, Санкт-Петербург,
Промышленная ул, дом № 19, литера Н,
помещение 100-Н Офис 331