



## Applications

- High isolation switching
- Detection
- Mixing
- Voltage control
- Tuning
- Phase shifting
- Receiver protection







## Features

- Low parasitic inductance 0.45 nH
- Low thermal impedance 50° C/W
- Small form factor 1.0 x 0.6 x 0.46 mm
- Frequency range 10 MHz–12 GHz

# Miniature 0402 Surface Mount Technology Packaged RF Diodes

Skyworks offers a variety of 0402 surface mount technology (SMT) diodes including PIN diodes for switch and attenuator applications, limiter diodes for receiver protection applications, Schottky diodes for detector and mixer applications and tuning varactor diodes for VCO, voltage tuned filters and phase shifter applications. These small form factor devices offer low parasitic inductance and low thermal impedance, making them ideal for a variety of markets including WLAN, WiMAX, cellular handset, cellular infrastructure, automotive, CATV/Satcom, smart energy, medical, military, RFID, and test and measurement.

### PIN Diodes for Switch and Attenuator Applications

Part Number	Feature/Application	Characteristics
 SMP1345-040LF	High Isolation Switching	Very Low Capacitance (0.13 pF), Isolation 40 dB
 SMP1340-040LF	Fast Switching/High Isolation	Low Capacitance, Fast Switching
 SMP1321-040LF	High Isolation	Low Capacitance
 SMP1320-040LF	Moderate Power Switching	Low Capacitance, Low Resistance
 SMP1352-040LF	High Power Switching	Low Distortion
 SMP1322-040LF	High Isolation Switching	Low Resistance (0.5 Ω Typ.)
 SMP1302-040LF	Attenuator	Low Distortion, Low Drive Current





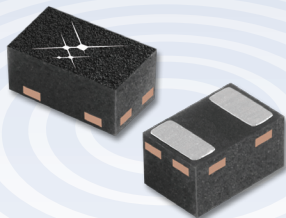

### Limiter Diodes for Receiver Protection Applications

Part Number	Feature/Application	Characteristics
 SMP1330-040LF	Low Capacitance, Low Threshold Level	Fast Recovery Time (5 ns Typ.)

 Skyworks Green™ products are compliant to all applicable materials legislation and are halogen-free. For additional information, refer to Skyworks Definition of Green™, document number SQ04-0074.



## Schottky Diodes for Detector and Mixer Applications

Part Number	Feature/Application	Characteristics
 SMS7621-040LF	High Sensitivity Detector	Low Barrier Height, Low Capacitance
 SMS7630-040LF	Most Sensitive Detector	Lowest Barrier Height, Low Capacitance
 SMS3922-040LF	Higher Input Power	Medium Barrier Height
 SMS3923-040LF	Higher Input Power	Medium Barrier Height
 SMS3924-040LF	High Sensitivity Detector	Medium/High Barrier, High Voltage Breakdown
 SMS3925-040LF	High Sensitivity/High Input Power	High Barrier Height

 Skyworks Green™ products are compliant to all applicable materials legislation and are halogen-free. For additional information, refer to Skyworks Definition of Green™, document number SQ04-0074.

## Tuning Varactor Diodes for VCO, Voltage Tuned Filters, and Phase Shifter Applications

Part Number	Feature/Application	Characteristics
SMV1213-040LF	Low Series Resistance, High Tuning Range	Capacitance (19 pF @ 1.0 V, 5.5 pF @ 4.0 V), $R_s$ (1.4 $\Omega$ )
SMV1248-040LF	High Tuning Range	Capacitance (11.3 pF @ 1.0 V, 1.57 pF @ 4.0 V), $R_s$ (2.0 $\Omega$ )
SMV1253-040LF	High Capacitance, Low Series Resistance	Capacitance (33.6 pF @ 1.0 V, 4.13 pF @ 4.0 V), $R_s$ (0.8 $\Omega$ )
SMV1255-040LF	Low Series Resistance, High Tuning Range	Capacitance (34.0 pF @ 1.0 V, 5.8 pF @ 4.0 V), $R_s$ (0.8 $\Omega$ )
SMV1430-040LF	Low Capacitance, Abrupt Junction	Capacitance (0.91 pF @ 1.0 V, 0.60 pF @ 4.0 V), $R_s$ (2.7 $\Omega$ )
SMV2019-040LF	High Capacitance Ratio at Low Voltage ( $C_{T1}/C_{T3} = 1.55$ Typ.)	Capacitance (1.43 pF @ 1.0 V, 0.23 pF @ 20.0 V), Q (500)
SMV1231-040LF	High Capacitance Ratio at Low Voltage ( $C_{T1}/C_{T3} = 1.65$ Typ.)	Capacitance (1.49 pF @ 1.0 V, 0.71 pF @ 4.0 V), $R_s$ (2.9 $\Omega$ )
SMV1232-040LF	High Capacitance Ratio at Low Voltage ( $C_{T1}/C_{T3} = 1.70$ Typ.)	Capacitance (2.52 pF @ 1.0 V, 1.18 pF @ 4.0 V), $R_s$ (1.2 $\Omega$ )
SMV1233-040LF	High Capacitance Ratio at Low Voltage ( $C_{T1}/C_{T3} = 1.70$ Typ.)	Capacitance (3.34 pF @ 1.0 V, 1.53 pF @ 4.0 V), $R_s$ (1.2 $\Omega$ )
SMV1234-040LF	Low Series Resistance, High Tuning Range	Capacitance (6.57 pF @ 1.0 V, 2.87 pF @ 4.0 V), $R_s$ (0.8 $\Omega$ )
SMV1235-040LF	Low Series Resistance, High Tuning Range	Capacitance (11.56 pF @ 1.0 V, 5.05 pF @ 4.0 V), $R_s$ (0.6 $\Omega$ )
SMV1236-040LF	Low Series Resistance, High Tuning Range	Capacitance (16.95 pF @ 1.0 V, 7.50 pF @ 4.0 V), $R_s$ (0.35 $\Omega$ )
SMV1405-040LF	Low Capacitance, High Q, Abrupt Junction	Capacitance (2.8 pF @ 0 V, 0.56 pF @ 30.0 V), Q (3200)
SMV1705-040LF	Low Series Resistance, High Tuning Range	Capacitance (18.49 pF @ 1.0 V, 6.13 pF @ 4.0 V), $R_s$ (0.3 $\Omega$ )
SMV1247-040LF	Low Capacitance, High Q	Capacitance (7 pF @ 0.3 V, 0.7 pF @ 4.7 V), Q (1500)
SMV1763-040LF	Low Capacitance, Low Series Resistance	Capacitance (6.7 pF @ 0.5 V, 2.6 pF @ 1.5 V), $R_s$ (0.7 $\Omega$ )
SMV1249-040LF	Wide Tuning Range	Capacitance (31 pF @ 0.3 V, 2.6 pF @ 4.7 V), CTR (12:1)

## PIN Diodes

PIN diodes are some of the most widely used diodes in the world and range in applications from RF switching in satellite television receiver low noise block converters (LNB), to automotive remote garage door openers, to land mobile radio transceivers and cable television automatic level controls.

PIN diodes are three layer diodes, comprised of a heavily doped anode (the “P” layer) and a heavily doped cathode (the “N” layer) separated by a virtually undoped intrinsic layer (the “I” layer). Under forward bias, charge carriers from the P and the N layers are forced into the I layer, which reduces its RF impedance. When a reverse bias voltage is applied across the PIN diodes, all free charge carriers are removed from the I layer, thereby causing its RF impedance to increase. This variable RF impedance versus DC, or low frequency bias signal, allows the diode to be used in RF switching circuits in which the PIN diode is either heavily forward-biased or reverse biased. In RF attenuation circuits, the PIN diode is utilized as a continuously-variable RF resistance by controlling the magnitude of the DC bias current through the diode.

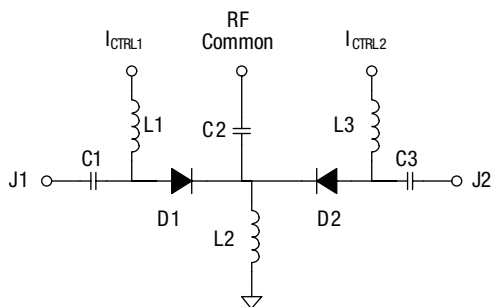

Wide Bandwidth Single Pole Double Throw Switch

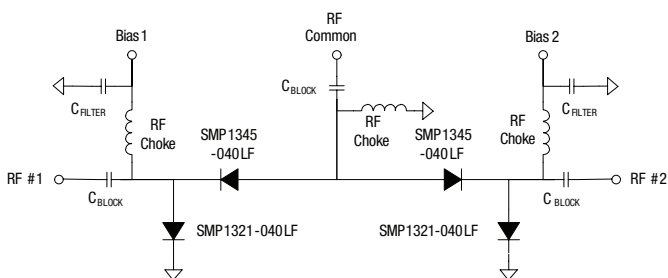

High Isolation PIN Diode Single Pole Double Throw Switch

## Switching Applications

The circuit below shows a pair of PIN diodes used to form a single pole, double throw switch. In this switch, a positive control current typically of the order of 10 mA is applied to one of the bias inputs to place that side of the switch into its low insertion loss state, while a negative bias voltage is applied to the other bias input, forcing the diode on that side of the switch into its maximum RF impedance state to produce high isolation on that side of the switch.

Many other switching circuit variations exist. Please refer to “Design with PIN Diodes” available on our Web site at [www.skyworksinc.com](http://www.skyworksinc.com) for more information.

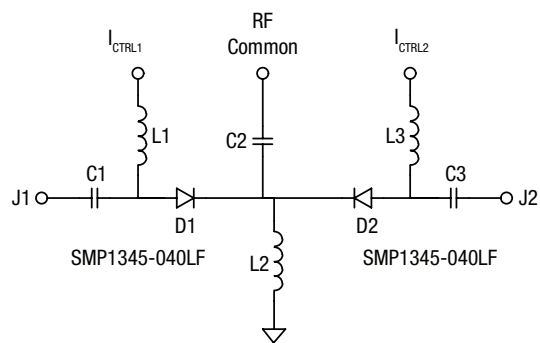

Typical SPDT Switch

## Attenuation Applications

A resistive attenuator can be built utilizing one or more PIN diodes. In this type of circuit, the RF resistance of the PIN diode is adjusted to a desired value by varying the magnitude of the DC bias current applied to the diode. This resistance produces attenuation.

The diagrams below show an attenuator that utilizes three PIN diodes. Many other PIN diode circuit configurations are also possible. Please refer to “Design with PIN Diodes” available on our Web site at [www.skyworksinc.com](http://www.skyworksinc.com) for more information.

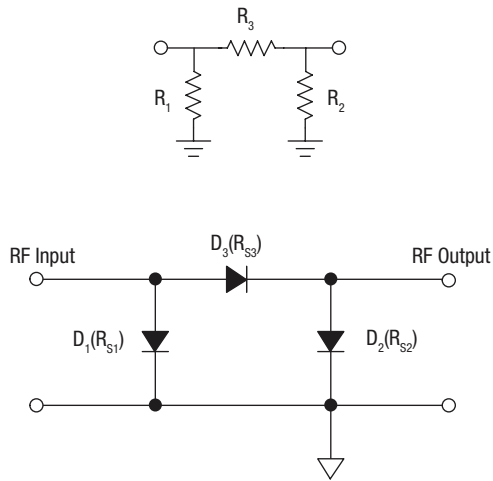

Pi Attenuator

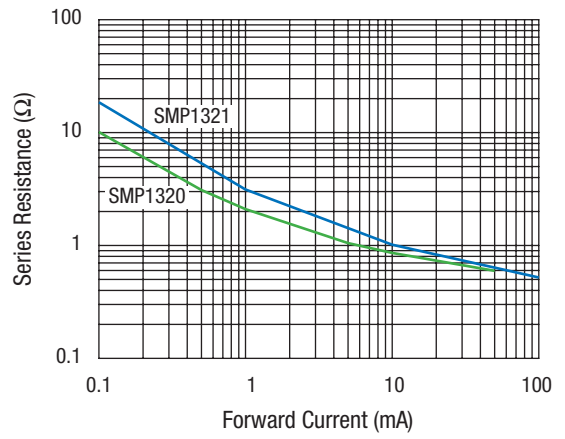

Series Resistance vs. Forward Current

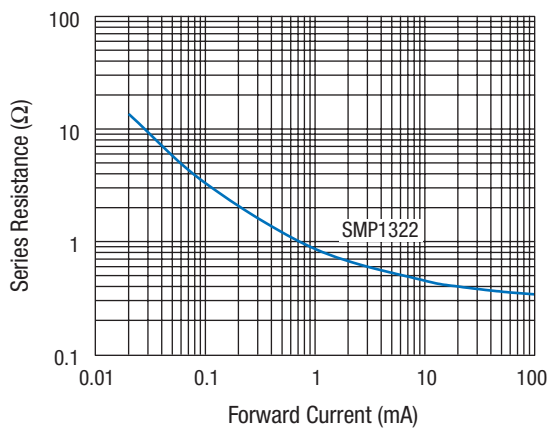

Series Resistance vs. Forward Current

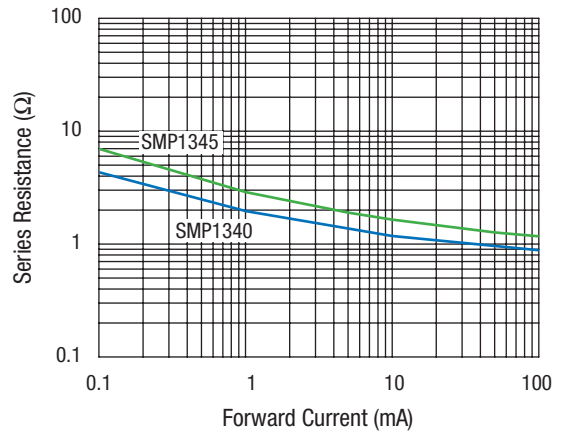

Series Resistance vs. Forward Current

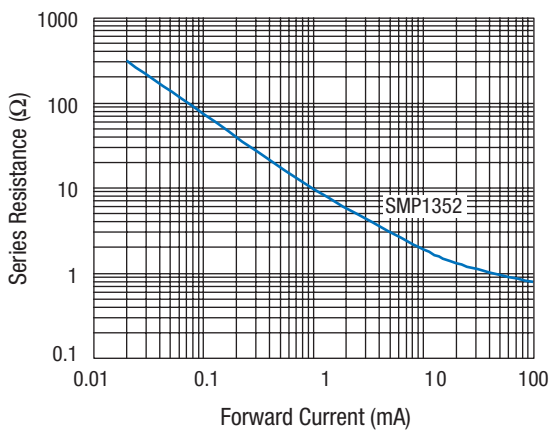



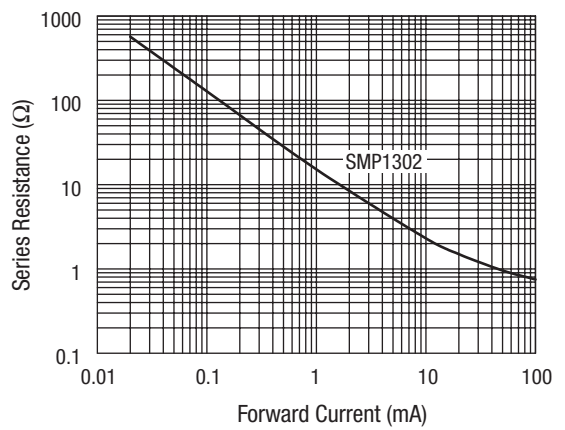



Series Resistance vs. Forward Current



Series Resistance vs. Forward Current

## PIN Diodes for Switch and Attenuator Applications

Part Number	Product Description	Key Features
 SMP1345-040LF	High Isolation Switching PIN Diode	Very Low Capacitance 0.14 pF, Isolation 40 dB
 SMP1340-040LF	Fast Switching/High Isolation PIN Diode	Low Capacitance, Low Series Resistance
 SMP1321-040LF	High Isolation (LNB/Multiswitch) PIN Diode	Low Capacitance, Series Pair
 SMP1320-040LF	Moderate Power Handling	Low Capacitance, Low Resistance
 SMP1352-040LF	High Power Switching	Lower Distortion
 SMP1322-040LF	High Isolation Switching	Low Resistance (0.5 $\Omega$ Typ.)
 SMP1302-040LF	Attenuator	Low Distortion/Low Drive Current

 Skyworks Green™ products are compliant to all applicable materials legislation and are halogen-free. For additional information, refer to Skyworks Definition of Green™, document number SQ04-0074.

## Electrical Specifications

Part Number	Max. $V_R$ $I_R = 10 \mu A$ (V)	$C_T$ $V_R = 30 V$ (pF)	$C_T$ $V_R = 5 V$ (pF)	$C_T$ $V_R = 20 V$ (pF)	Typ. $V_F$ $I_F = 10 mA$ (V)	$R_S$ $I_F = 1 mA$ $F = 100 MHz$ ( $\Omega$ )	Max. $R_S$ $I_F = 10 mA$ $F = 100 MHz$ ( $\Omega$ )	$R_S$ $I_F = 100 mA$ $F = 100 MHz$ ( $\Omega$ )	Typ. Carrier Lifetime $I_F = 10 mA$ (ns)
SMP1345-040LF	50	–	0.20 Max.	–	0.89	3.5 Typ.	2.0	–	100
SMP1340-040LF	50	–	0.30 Max.	–	0.85	–	1.2	–	100
SMP1321-040LF	100	0.025 Max.	–	–	0.85	3.0 Typ.	2.0	–	400
SMP1320-040LF	50	0.25 Max.	–	–	0.85	2.0 Typ.	0.9	–	400
SMP1352-040LF	200	–	–	0.30 Max.	0.80	15 Max.	2.8	1.35 Max.	1000
SMP1322-040LF	50	1.0 Max.	–	–	0.85	1.5 Max.	0.5 Typ.	–	400
SMP1302-040LF	200	0.30 Max.	–	–	0.80	20 Max.	3.0	1.5 Max.	700

## Limiter Diodes

The PIN limiter diode can be described as an incident power controlled, variable resistor. In the case when no large input signal is present, the impedance of the limiter diode is at its maximum, thereby producing minimum insertion loss, typically less than 0.5 dB. The presence of a large input signal temporarily forces the impedance of the diode to a much lower value, producing an impedance mismatch which reflects the majority of the input signal power back towards its source.

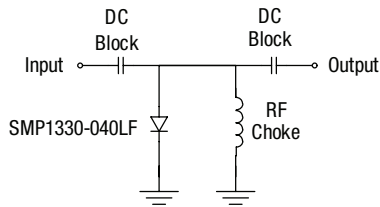

A Single Stage Limiter

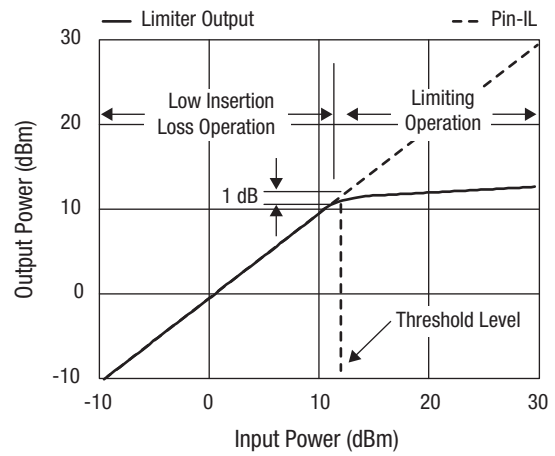

Output Power vs. Input Power for a Single Stage Limiter

## Limiter Diodes for Receiver Protection Applications

Part Number	Feature/Application	Characteristics
 SMP1330-040LF	Low Capacitance, Low Threshold Level	Fast Recovery Time (5 ns Typ.)

 Skyworks Green™ products are compliant to all applicable materials legislation and are halogen-free. For additional information, refer to Skyworks Definition of Green™, document number SQ04-0074.

## Electrical Specifications

Part Number	$V_B I_R = 10 \mu A$ (V)	I Region Thickness ( $\mu m$ ) Nominal	$C_T$ (pF) 0 V, F = 1 MHz	$C_T$ (pF) 0 V, F = 1 GHz	$R_S I_F = 10 mA$ F = 100 MHz ( $\Omega$ )	Carrier Lifetime $T_L$ (ns) IF = 10 mA
SMP1330-040LF	20–50	2	0.7 Typ., 1.0 Max.	0.7 Typ.	1.25 Typ., 1.9 Max.	4.0 Typ.

## Schottky Diodes

Schottky diodes are optimized for use in detector and mixer applications at frequencies from below 10 MHz to higher than 20 GHz. Skyworks' family of products include medium, low and zero bias detector (ZBD) barrier height Schottky junctions with low junction capacitance and low series resistance.

Schottky junctions are formed by depositing specific metals on either n-doped silicon (low or medium barrier height) or on p-doped silicon (ZBD barrier height). The characteristics of the diode are determined by the type of metal deposited on the semiconductor material, as well as the type of dopant in the semiconductor layer, among other parameters.

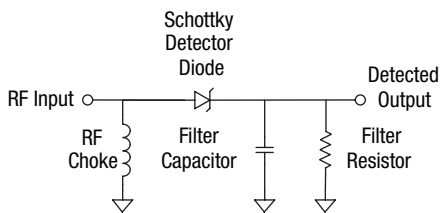

Single Schottky Diode Detector

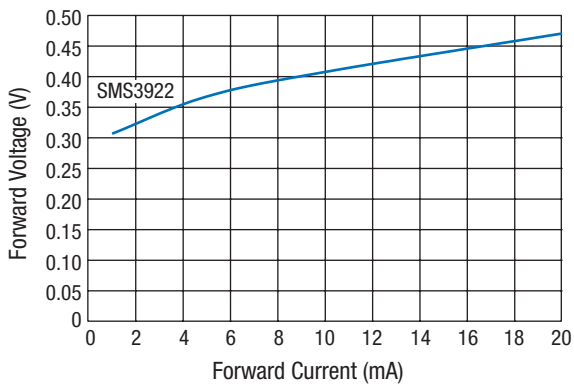

Forward Voltage vs. Forward Current

## SMS7621-040LF Schottky Detector Diode

The SMS7621-040LF combines low capacitance (nominally 0.2 pF) and low barrier height to produce a detector diode with excellent sensitivity.

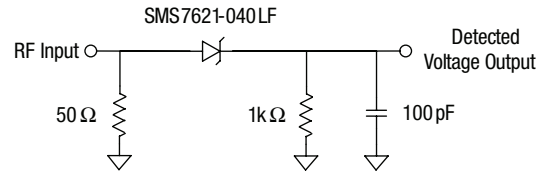

Broadband Detector Circuit

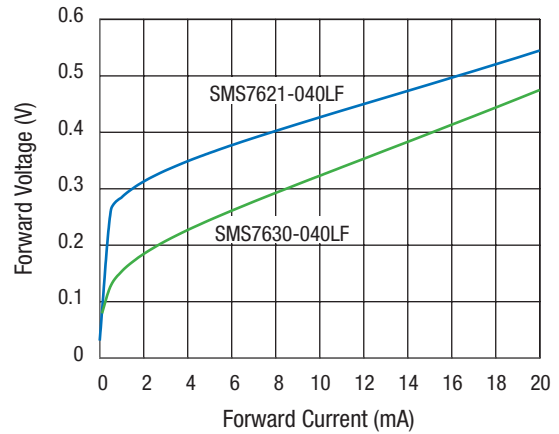

Forward Voltage vs. Forward Current

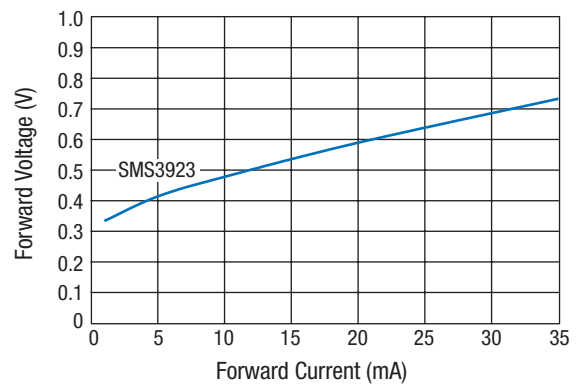

Forward Voltage vs. Forward Current

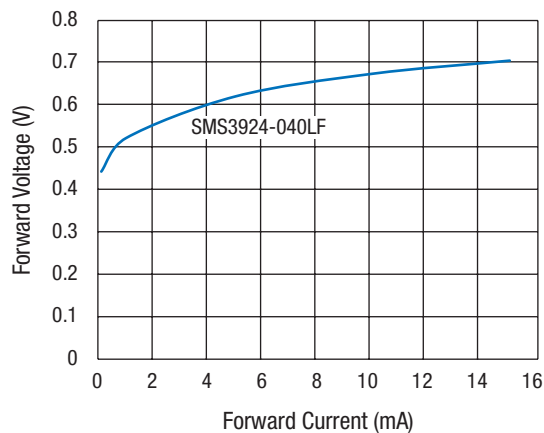

Forward Voltage vs. Forward Current ( $T_A = 25^\circ\text{C}$ )

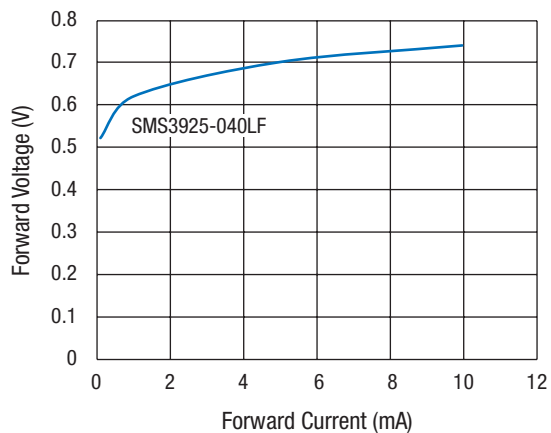

Forward Voltage vs. Forward Current ( $T_A = 25^\circ\text{C}$ )

### Schottky Diodes for Detector and Mixer Applications

Part Number	Feature/Application	Characteristics
SMS7621-040LF	High Sensitivity Detector	Low Barrier Height and Low Capacitance
SMS7630-040LF	Most Sensitive Detector	Lowest Barrier Height, Low Capacitance
SMS3922-040LF	Higher Input Power	Medium Barrier Height
SMS3923-040LF	Higher Input Power	Medium Barrier Height
SMS3924-040LF	High Sensitivity/High Input Power	Medium/High Barrier Height
SMS3925-040LF	High Sensitivity	High Barrier Height

### Electrical Specifications

Part Number	$V_B$ $I_R = 10 \mu\text{A}$ (V)	Max. $V_F$ $I_F = 1 \text{ mA}$ (mV)	Max. $C_T$ $V_R = 0 \text{ V}$ (pF)	Typ. $R_T$ $I_F = 5 \text{ mA}$ $F = 100 \text{ MHz}$ ( $\Omega$ )	Typ. $R_V$ ( $\Omega$ )
SMS7621-040LF	2 Min.	320	0.25	18	–
SMS7630-040LF	1 Min.*	240	0.35	–	5k
SMS3922-040LF	8 Min.	340	1.03	9	–
SMS3923-040LF	20 Min.	370	1.23	10	–
SMS3924-040LF	70 Min.	550	2.25	7 @ 10 mA	–
SMS3925-040LF	40 Min.	650	0.42	10 @ 10 mA	–

\* $I_R = 100 \mu\text{A}$



## Tuning Varactor Diodes

Skyworks series of silicon tuning varactor diodes are used as the electrical tuning elements in voltage controlled oscillators (VCOs), voltage variable analog phase shifters and voltage tuned filters (VTFs). This family of diodes includes abrupt junction tuning varactors, useful for low loss, narrow band circuits, and hyperabrupt junction varactors, useful for wide bandwidth VCOs and VTFs as well as wide phase range variable phase shifters.

Tuning varactors are PN junction diodes. The depletion region that forms at the junction of the diode acts as a nearly-ideal insulator, which separates the highly-doped anode from the cathode layer, thus forming a parallel plate capacitor. The thickness of the depletion layer can be increased by applying a reverse bias voltage to the diode.

The cathode layer's doping profile is very carefully designed to produce a tightly controlled capacitance versus reverse bias voltage performance characteristic. The cathode layer of an abrupt junction diode has uniform dopant concentration throughout its thickness, which results in a low series resistance and moderately large change in capacitance versus bias voltage. By contrast, the doping concentration of cathode layer of hyperabrupt varactor diode is designed to change by several orders of magnitude, typically over the depth of a few microns. This non-constant dopant concentration versus depth of the hyperabrupt diode's cathode layer produces a much larger available change in capacitance versus reverse voltage, necessary for wide bandwidth or phase shift range applications.

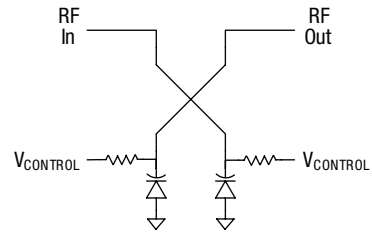

Phase Shifter Diagram

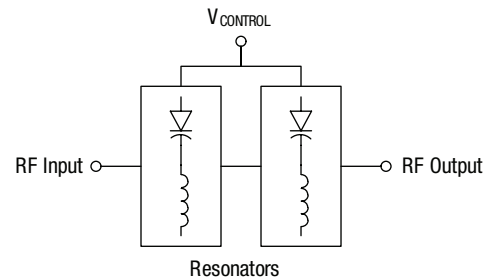

Voltage Tuned Filter Diagram

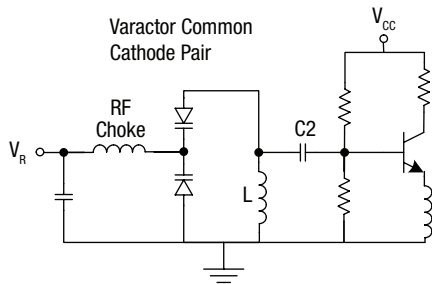

Typical Voltage Controlled Oscillator with a Common Cathode Pair of Tuning Varactors

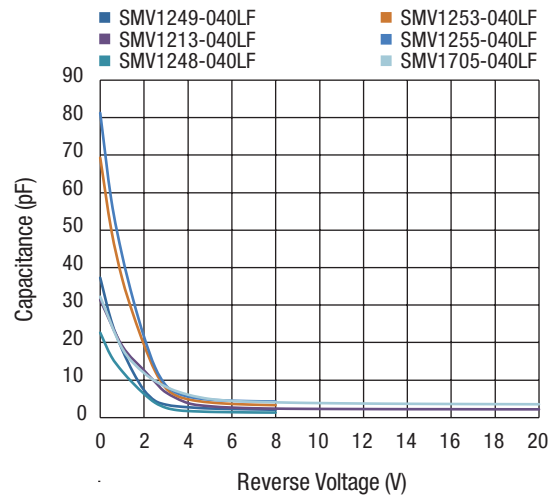

Capacitance vs. Reverse Voltage

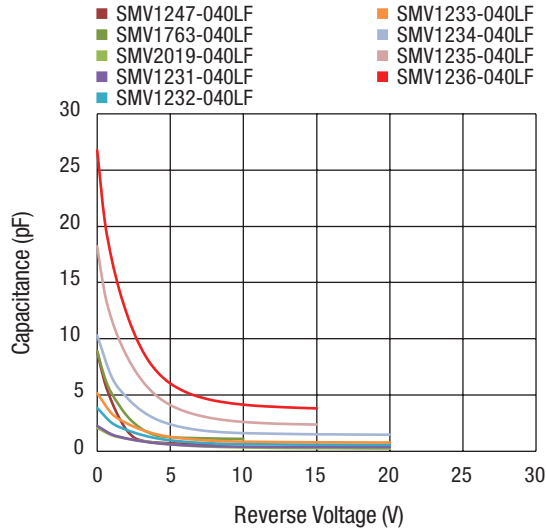

Capacitance vs. Reverse Voltage

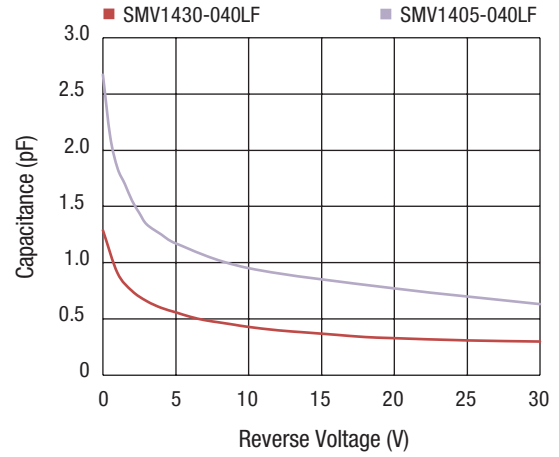

Capacitance vs. Reverse Voltage

### Tuning Varactor Diodes for VCO, Voltage Tuned Filters, and Phase Shifter Applications

Part Number	Min. Reverse Breakdown Voltage, $V_R$ IR = 10 $\mu$ A (V) <sup>1</sup>	Typ. Total Capacitance <sup>3</sup> , $C_T$ $V_R = 1$ V (pF)	Typ. Total Capacitance <sup>3</sup> , $C_T$ $V_R = 4$ V (pF)	Typ. Total Capacitance <sup>3</sup> , $C_T$ $V_R = 8$ V (pF)	Min. Total Capacitance Ratio	Capacitance Ratio Range (V)	Max. Series Resistance, $R_s$ ( $\Omega$ )
SMV1213-040LF	12	19.13	3.87	2.4	2	1.0 to 2.5	1.4 Typ. @ 3.0 V
SMV1248-040LF	15	11.31	1.57	1.21	10.8	0.3 to 4.7	3.3 @ 3.0 V
SMV1253-040LF	15	33.69	4.63	3.4	11	0.3 to 4.7	1.4 @ 3.0 V
SMV1255-040LF	15	39.95	5.79	3.94	11	0.3 to 4.7	1.3 @ 3.0 V
SMV1430-040LF	30	0.91	0.6	0.47	3.8	0 to 30	2.7 Typ. @ 4.0 V
SMV2019-040LF	22	1.43	0.75	0.39	2.1	4 to 20	Q @ 4 V = >500
SMV1231-040LF	15	1.49	0.71	0.43	1.45	1 to 3.0	2.9 @ 3.0 V
SMV1232-040LF	15	2.52	1.18	0.71	1.5	1 to 3.0	1.5 @ 3.0 V
SMV1233-040LF	15	3.34	1.53	0.93	1.5	1 to 3.0	1.2 @ 3.0 V
SMV1234-040LF	15	6.57	2.87	1.75	1.6	1.0 to 3.0	1.2 @ 3.0 V
SMV1235-040LF	15	11.67	4.99	2.91	1.6	1.0 to 3.0	0.6 @ 3.0 V
SMV1236-040LF	15	17.02	7.19	4.49	1.6	1.0 to 3.0	0.5 @ 3.0 V
SMV1405-040LF	30	1.95	1.26	0.97	2.8	0 to 30 V	0.8 @ 4.0 V
SMV1705-040LF	12	18.49	6.13	4.08	2.8	1.0 to 4.0	0.32 Typ. @ 1.0 V
SMV1247-040LF	15	4.37	0.77	0.64	9.5	0.3 to 4.7	2.6 Typ. @ 3.0 V
SMV1763-040LF	10	5.13	1.44	1.15	2.3	0.5 to 2.5	0.7 Typ. @ 1.0 V
SMV1249-040LF	15	18.18	2.72	2.03	11.0	0.3 to 4.7	1.2 Typ. @ 3.0 V

## 0402 Package Information

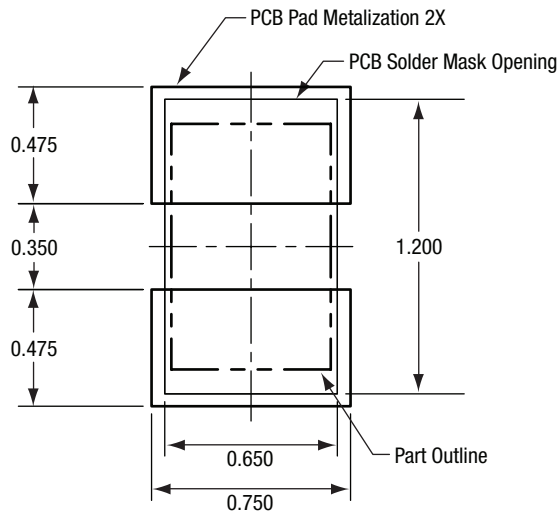

All measurements in millimeters

S1997

PCB Layout Footprint

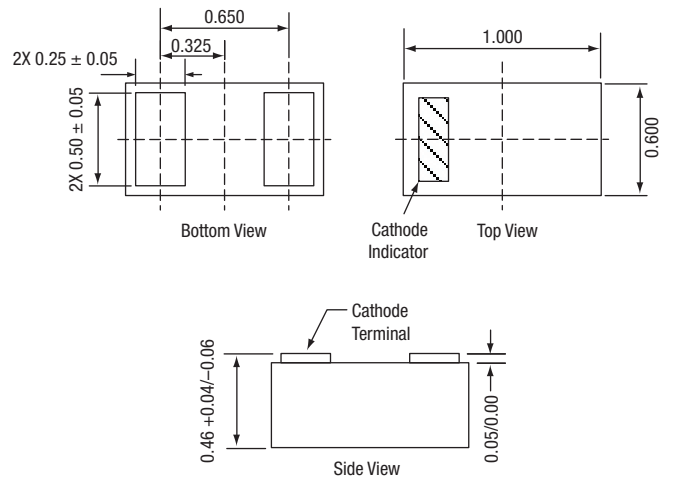

All dimensions in millimeters

S1892

Package Dimensions

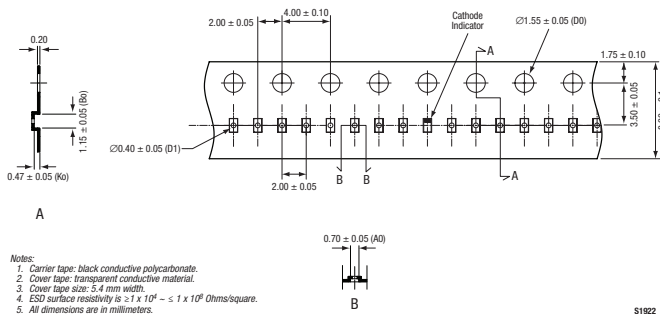

S1922

Tape and Reel Dimensions



Through our Green Initiative™, we are committed to manufacturing products that comply with global government directives and industry requirements.

Skyworks is continuously innovating RF, analog and mixed-signal ICs. For the latest product introductions and information about Skyworks, visit our Web site at [www.skyworksinc.com](http://www.skyworksinc.com)

For additional information on our broad overall product portfolio, please contact your local sales office or email us at [sales@skyworksinc.com](mailto:sales@skyworksinc.com).

**Skyworks Solutions, Inc.**

20 Sylvan Road, Woburn, MA 01801

USA: (781) 376-3000 • Asia: 886 2 2735 0399

Europe: 33 (0)1 43548540 • Fax: (781) 376-3100

Email: [sales@skyworksinc.com](mailto:sales@skyworksinc.com) • [www.skyworksinc.com](http://www.skyworksinc.com)





## Стандарт Электрон Связь

Мы молодая и активно развивающаяся компания в области поставок электронных компонентов. Мы поставляем электронные компоненты отечественного и импортного производства напрямую от производителей и с крупнейших складов мира.

Благодаря сотрудничеству с мировыми поставщиками мы осуществляем комплексные и плановые поставки широчайшего спектра электронных компонентов.

Собственная эффективная логистика и склад в обеспечивает надежную поставку продукции в точно указанные сроки по всей России.

Мы осуществляем техническую поддержку нашим клиентам и предпродажную проверку качества продукции. На все поставляемые продукты мы предоставляем гарантию .

Осуществляем поставки продукции под контролем ВП МО РФ на предприятия военно-промышленного комплекса России , а также работаем в рамках 275 ФЗ с открытием отдельных счетов в уполномоченном банке. Система менеджмента качества компании соответствует требованиям ГОСТ ISO 9001.

Минимальные сроки поставки, гибкие цены, неограниченный ассортимент и индивидуальный подход к клиентам являются основой для выстраивания долгосрочного и эффективного сотрудничества с предприятиями радиоэлектронной промышленности, предприятиями ВПК и научно-исследовательскими институтами России.

С нами вы становитесь еще успешнее!

### Наши контакты:

**Телефон:** +7 812 627 14 35

**Электронная почта:** [sales@st-electron.ru](mailto:sales@st-electron.ru)

**Адрес:** 198099, Санкт-Петербург,  
Промышленная ул, дом № 19, литера Н,  
помещение 100-Н Офис 331