

**MV5052
MV5053/6053**

**MV5054A-1/2/3
MV5055**

PACKAGE DIMENSIONS

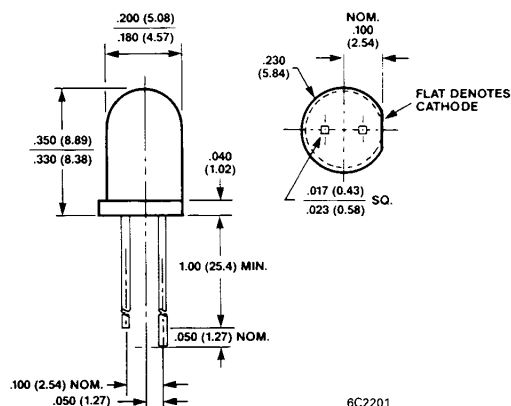

DESCRIPTION

The MV505X Series of industry standard solid state indicators is made with gallium arsenide phosphide light emitting diodes encapsulated in epoxy lenses. Various lens effects give different design possibilities.

FEATURES

- Standard Red light source with various lens colors and effects
- Versatile mounting on PC board or panel
- Snap in mounting grommet MP52
- Long life—solid state reliability
- Low power requirements
- Compact, rugged, lightweight

PHYSICAL CHARACTERISTICS

| CATHODE LONG | SOURCE COLOR | LENS TYPE | LENS EFFECT | APPLICATION |
|--------------|--------------|--------------|----------------|--------------|
| MV5052 | Standard Red | Red Tint | Point Source | Backlighting |
| MV5053* | Standard Red | Red Diffused | Wide Beam | Direct View |
| MV5054A-1 | Standard Red | Red Diffused | Narrow Beam | Direct View |
| MV5054A-2 | Standard Red | Red Diffused | Narrow Beam | Direct View |
| MV5054A-3 | Standard Red | Red Diffused | Narrow Beam | Direct View |
| MV5055 | Standard Red | Red Diffused | Very Wide Beam | Direct View |

*MV6053 – Anode Long also available.

| ELECTRO OPTICAL CHARACTERISTICS ($T_A=25^\circ\text{C}$ Unless Otherwise Specified) | | | | | | | | |
|---|----------------------------|------|--------------|---------|---------|---------|------|---------------|
| PARAMETER | TEST COND. | 5052 | 6053 5053 | 5054A-1 | 5054A-2 | 5054A-3 | 5055 | UNIT |
| Luminous Intensity I_v min. | $I_f=20$ mA $I_f=10$ mA | 0.7 | 0.5 | 1.0 | 2.0 | 3.0 | 0.1 | mcd mcd |
| Forward voltage V_f mcd | $I_f=20$ mA $I_f=10$ mA | 2.2 | 2.2 | 2.2 | 2.2 | 2.2 | 2.2 | V V |
| Peak wavelengths λ_p typical | $I_f=20$ mA | 660 | 660 | 660 | 660 | 660 | 660 | nm |
| Spectral line half width typical | $I_f=20$ mA | 20 | 20 | 20 | 20 | 20 | 20 | nm |
| Capacitance typical | $V=0$ $f=1$ MHz | 30 | 30 | 30 | 30 | 30 | 30 | pF |
| Reverse current I_R max. | $V_R=5.0$ V | 100 | 100 | 100 | 100 | 100 | 100 | μA |
| Viewing angle typical, See Figures | | 72 | 80 | 24 | 24 | 24 | 150 | degrees |

| ABSOLUTE MAXIMUM RATINGS ($T_A=25^\circ\text{C}$ Unless Otherwise Specified) | |
|--|-----------------|
| Power dissipation | 180 mW |
| Derate linearly from 25° | 2.0 mW/°C |
| Storage and operating temperatures | -55°C to +100°C |
| Lead soldering time at 260°C (See Note 2) | 5 sec. |
| Continuous forward current | 100 mA |
| Peak forward current (1 μ sec pulse, 0.3% duty cycle) | 1.0 A |
| Reverse voltage | 5.0 V |

| NOTES |
|---|
| 1. The axis of spatial distribution are typically within a 10° cone with reference to the central axis of the device. |
| 2. The leads of the device were immersed in molten solder at 260°C to a point 1/16(1.6 mm) from the body of the device per MIL-S-750, with a dwell time of 5 seconds. |

TYPICAL ELECTRO-OPTICAL CHARACTERISTICS (25°C Free Air Temperature)

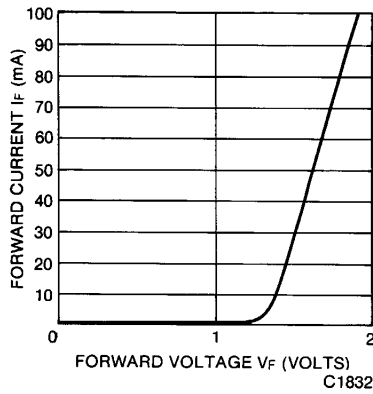

Fig. 1. Forward Current vs. Forward Voltage

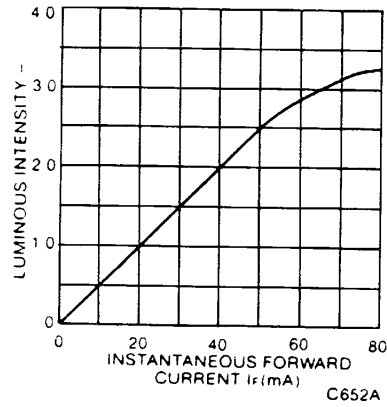

Fig. 2. Luminous Intensity vs. Forward Current

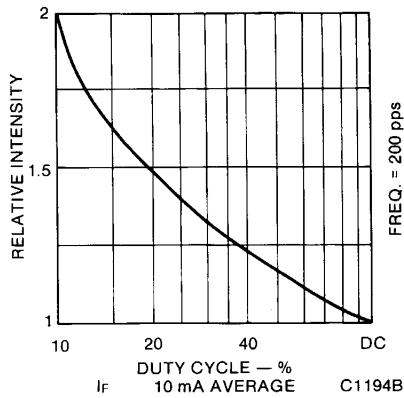

Fig. 3. Luminous Intensity vs. Duty Cycle

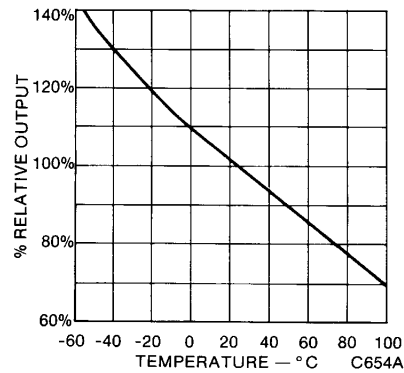

Fig. 4. Output vs. Temperature

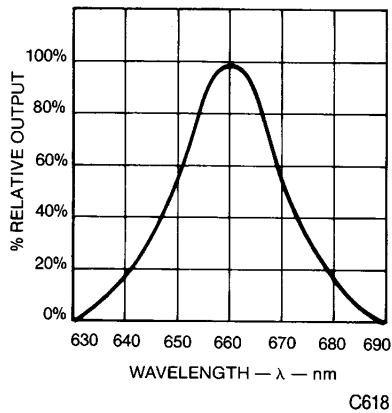

Fig. 5. Spectral Distribution

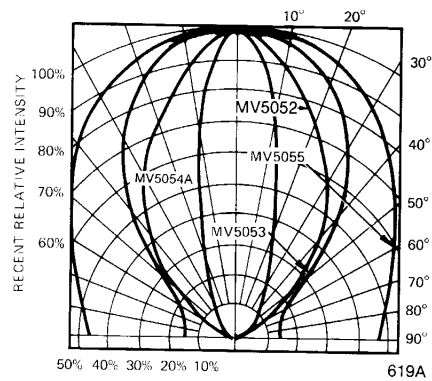

Fig. 6. Spatial Distribution (Note 1)



STANDARD RED T-1 3/4 SOLID STATE LAMPS

DISCLAIMER

FAIRCHILD SEMICONDUCTOR RESERVES THE RIGHT TO MAKE CHANGES WITHOUT FURTHER NOTICE TO ANY PRODUCTS HEREIN TO IMPROVE RELIABILITY, FUNCTION OR DESIGN. FAIRCHILD DOES NOT ASSUME ANY LIABILITY ARISING OUT OF THE APPLICATION OR USE OF ANY PRODUCT OR CIRCUIT DESCRIBED HEREIN; NEITHER DOES IT CONVEY ANY LICENSE UNDER ITS PATENT RIGHTS, NOR THE RIGHTS OF OTHERS.

LIFE SUPPORT POLICY

FAIRCHILD'S PRODUCTS ARE NOT AUTHORIZED FOR USE AS CRITICAL COMPONENTS IN LIFE SUPPORT DEVICES OR SYSTEMS WITHOUT THE EXPRESS WRITTEN APPROVAL OF THE PRESIDENT OF FAIRCHILD SEMICONDUCTOR CORPORATION. As used herein:

1. Life support devices or systems are devices or systems which, (a) are intended for surgical implant into the body, or (b) support or sustain life, and (c) whose failure to perform when properly used in accordance with instructions for use provided in the labeling, can be reasonably expected to result in a significant injury of the user.
2. A critical component in any component of a life support device or system whose failure to perform can be reasonably expected to cause the failure of the life support device or system, or to affect its safety or effectiveness.



**Стандарт
Электрон
Связь**

Мы молодая и активно развивающаяся компания в области поставок электронных компонентов. Мы поставляем электронные компоненты отечественного и импортного производства напрямую от производителей и с крупнейших складов мира.

Благодаря сотрудничеству с мировыми поставщиками мы осуществляем комплексные и плановые поставки широчайшего спектра электронных компонентов.

Собственная эффективная логистика и склад в обеспечивает надежную поставку продукции в точно указанные сроки по всей России.

Мы осуществляем техническую поддержку нашим клиентам и предпродажную проверку качества продукции. На все поставляемые продукты мы предоставляем гарантию .

Осуществляем поставки продукции под контролем ВП МО РФ на предприятия военно-промышленного комплекса России , а также работаем в рамках 275 ФЗ с открытием отдельных счетов в уполномоченном банке. Система менеджмента качества компании соответствует требованиям ГОСТ ISO 9001.

Минимальные сроки поставки, гибкие цены, неограниченный ассортимент и индивидуальный подход к клиентам являются основой для выстраивания долгосрочного и эффективного сотрудничества с предприятиями радиоэлектронной промышленности, предприятиями ВПК и научно-исследовательскими институтами России.

С нами вы становитесь еще успешнее!

Наши контакты:

Телефон: +7 812 627 14 35

Электронная почта: sales@st-electron.ru

Адрес: 198099, Санкт-Петербург,
Промышленная ул, дом № 19, литера Н,
помещение 100-Н Офис 331