

Distinctive Characteristics

Antijamming design protects against mechanism damage from downward force on the actuator.

O-ring surrounding top of lever prevents liquids from reaching switch mechanism.

Ultrasonic welding of upper and lower housing seals out contaminants and allows automated soldering and cleaning.

Terminals are epoxy sealed to prevent entry of flux, solvents, and other contaminants.

Bracketed models have crimped bracket legs to ensure secure PC mounting and prevent dislodging during automated soldering.

Logic level and power capabilities are available to suit varying applications.

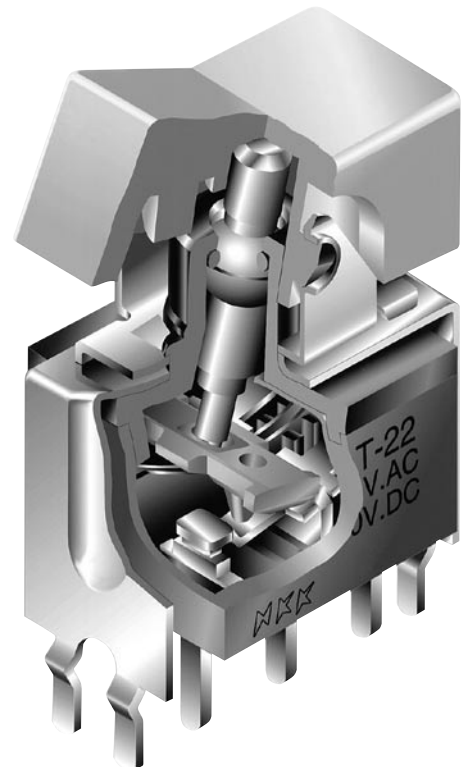

Actual Size

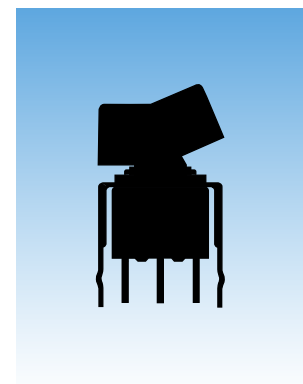

General Specifications

Electrical Capacity (Resistive Load)

Power Level (code W): 6A @ 125V AC or 3A @ 250V AC;
4A @ 30V DC (On-On circuit) & 3A @ 30V DC (all other circuits)

Logic Level (code G): 0.4VA maximum @ 28V AC/DC maximum
(Applicable Range 0.1mA ~ 0.1A @ 20mV ~ 28V)

Logic/Power Level (code A): Combines W & G ratings
Note: Find additional explanation of dual rating & operating range in Supplement section.

Other Ratings

Contact Resistance: 10 milliohms maximum for silver; 20 milliohms maximum for gold

Insulation Resistance: 1,000 megohms minimum @ 500V DC

Dielectric Strength: 1,000V AC minimum between contacts for 1 minute minimum;
1,500V AC minimum between contacts & case for 1 minute minimum

Mechanical Life: 50,000 operations minimum

Electrical Life: 25,000 operations minimum for silver; 50,000 operations minimum for gold

Contact Timing: Nonshorting (break-before-make)

Angle of Throw: 26°

Materials & Finishes

Lever: Brass with chrome plating

Actuator Clip: Polyacetal

Support Bracket: Brass with tin plating

Bushing/Housing: Glass fiber reinforced polyamide (UL94V-0)

Sealing Ring: Nitrile butadiene rubber

Base: Glass fiber reinforced polyamide (UL94V-0)

Movable Contacts: Silver alloy with silver plating (code W); copper or phosphor bronze with gold plating (code G);
or silver alloy with gold plating (code A)

Stationary Contacts: Silver alloy with silver plating (code W); copper or brass with gold plating (code G);
or silver alloy with gold plating (code A)

Terminals: Copper or brass with silver or gold plating

Environmental Data

Operating Temp Range: -30°C through +85°C (-22°F through +185°F)

Humidity: 90 ~ 95% humidity for 96 hours @ 40°C (104°F)

Vibration: 10 ~ 55Hz with peak-to-peak amplitude of 1.5mm traversing the frequency range
& returning in 1 minute; 3 right angled directions for 2 hours

Shock: 50G (490m/s²) acceleration (tested in 6 right angled directions, with 5 shocks in each direction)

PCB Processing

Soldering: Wave Soldering Recommended: See Profile B in Supplement section.

Manual Soldering: See Profile B in Supplement section.

Cleaning: Automated cleaning. See Cleaning specifications in Supplement section.

Standards & Certifications

Flammability Standards: UL94V-0 rated bushing/housing & base



UL Recognized: All models recognized at 6A @ 125V AC, 3A @ 250V AC, & 4A @ 30V DC or 0.4A @ 28V DC;
UL File No. WOYR2.E44145; add "/U" to end of part number to order UL mark on switch.



C-UL Recognized: All models recognized at 6A @ 125V AC, 3A @ 250V AC, & 4A @ 30V DC or 0.4A @ 28V DC;
C-UL File No. WOYR8.E44145; add "/C-UL" to end of part number to order C-UL mark on switch.



CSA Certified: All models certified at 6A @ 125V AC, 3A @ 250V AC, & 4A @ 30V DC;

CSA File No. 023535-0-000;

add "/C" to end of part number to order CSA mark on switch.

TYPICAL SWITCH ORDERING EXAMPLE

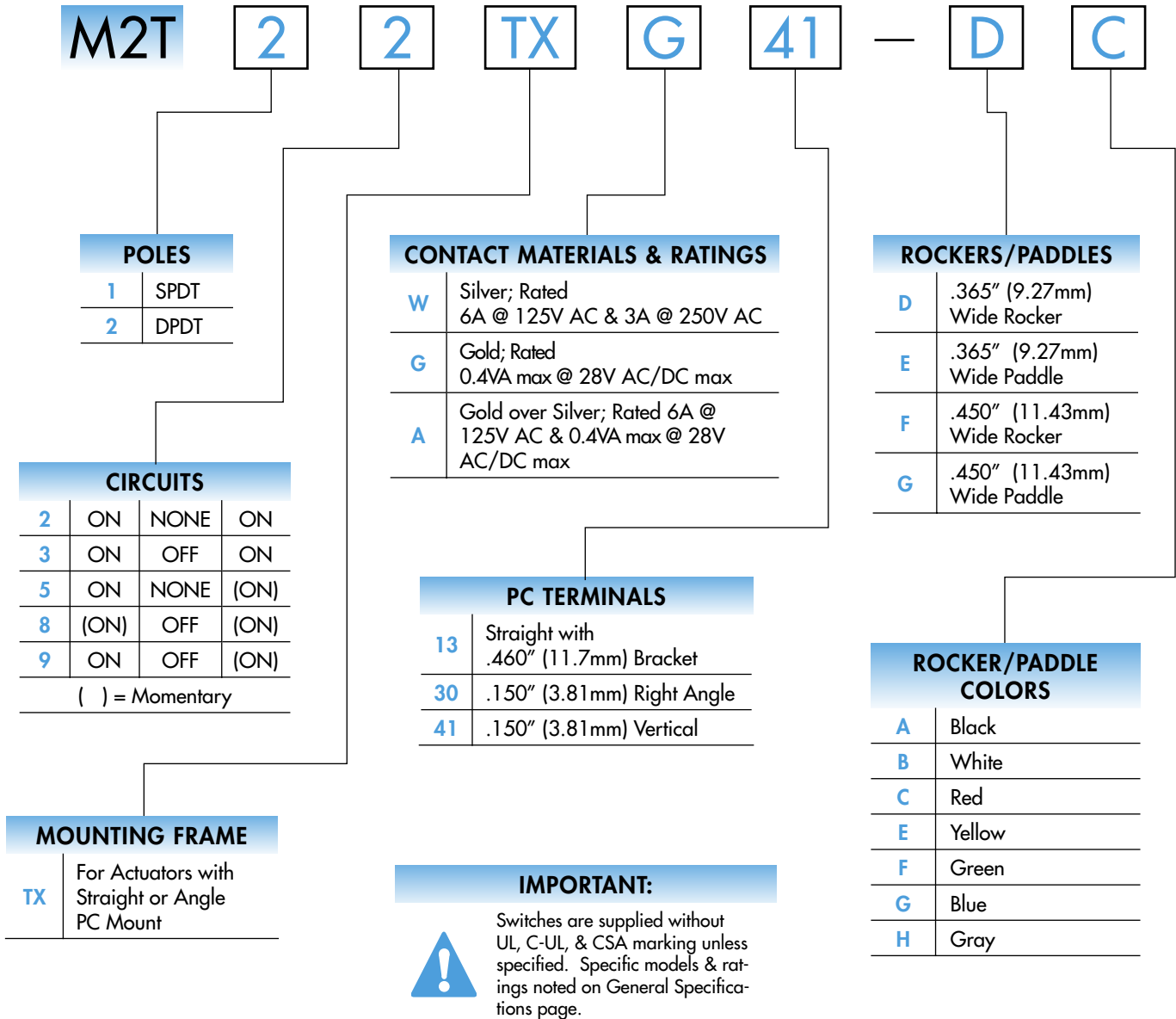

DESCRIPTION FOR TYPICAL ORDERING EXAMPLE

M2T22TXG41-DC

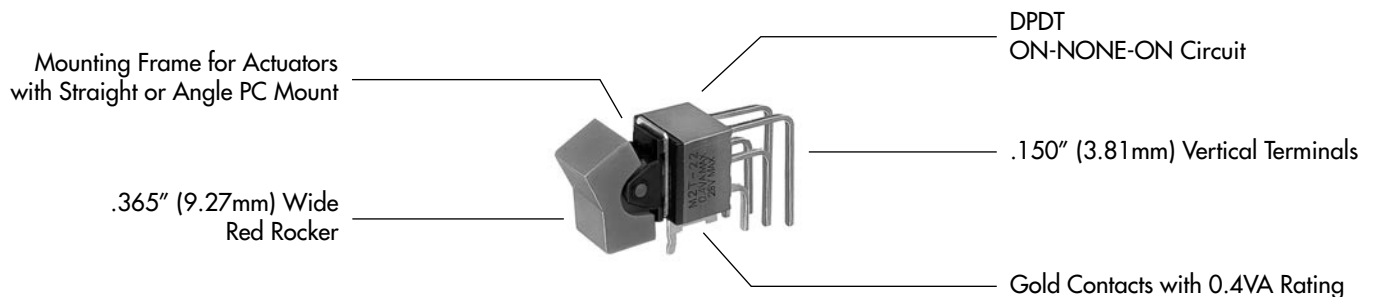

POLES & CIRCUITS

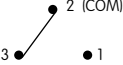
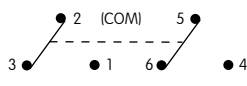
Pole	Model	Rocker Position () = Momentary			Connected Terminals			Throw & Schematics
		Down	Center	Up	Down	Center	Up	
SP	M2T12	ON	NONE	ON	2-3	OPEN	2-1	SPDT 
	M2T13	ON	OFF	ON				
	M2T15	ON	NONE	(ON)				
	M2T18	(ON)	OFF	(ON)				
	M2T19	ON	OFF	(ON)				
DP	M2T22	ON	NONE	ON	2-3 5-6	OPEN	2-1 5-4	DPDT 
	M2T23	ON	OFF	ON				
	M2T25	ON	NONE	(ON)				
	M2T28	(ON)	OFF	(ON)				
	M2T29	ON	OFF	(ON)				

MOUNTING FRAME

TX Mounting Frame for Rockers or Paddles with Straight or Angle PC Terminals

Straight PC Mounting

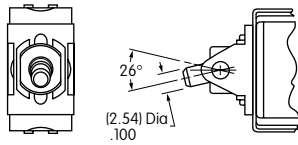

Right Angle PC Mounting

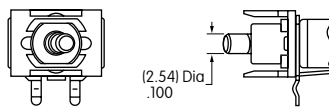

Vertical PC Mounting

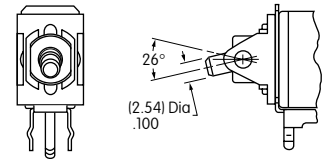

Actuators & Panel Cutouts

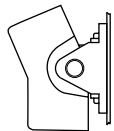

AT4148

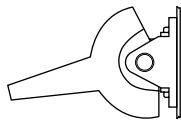

AT4149

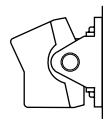
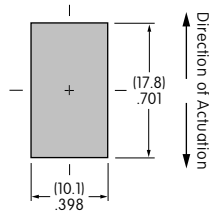

AT4150

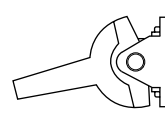

AT4151

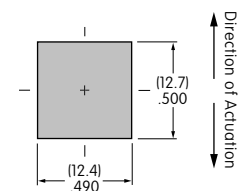

CONTACT MATERIALS & RATINGS

W Silver over Silver Power Level 6A @ 125V AC & 3A @ 250V AC

G Gold over Brass or Copper Logic Level 0.4VA maximum @ 28V AC/DC maximum
Complete explanation of operating range in Supplement section.

A Gold over Silver Power Level or Logic Level 6A @ 125V AC or 0.4VA maximum @ 28V AC/DC maximum

Note: This dual rated option is suitable when two or more identical switches are used in logic and in power circuits within the same application. See Supplement section for complete explanation of dual rating and operating range.

PC TERMINALS

13 Straight with
.460" (11.7mm)
Bracket

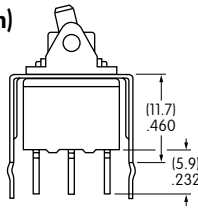

30 .150" (3.81mm)
Right Angle

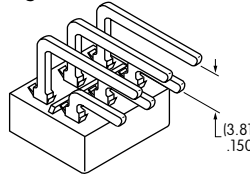

41 .150" (3.81mm)
Vertical

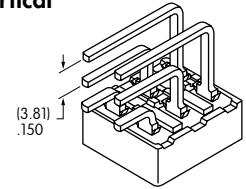

ROCKERS & PADDLES

D AT4148
.365" (9.27mm) Wide Rocker

Material: Polyamide
Finish: Matte

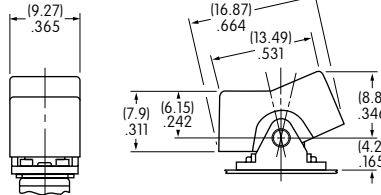

E AT4149
.365" (9.27mm) Wide Paddle

Material: Polyamide
Finish: Matte

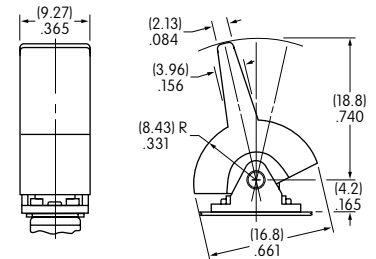

F AT4150
.450" (11.43mm) Wide Rocker

Material: Polyamide
Finish: Matte

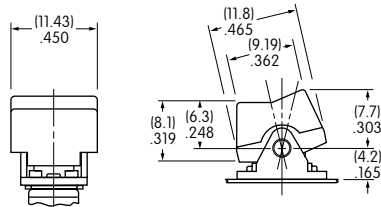

G AT4151
.450" (11.43mm) Wide Paddle

Material: Polyamide
Finish: Matte

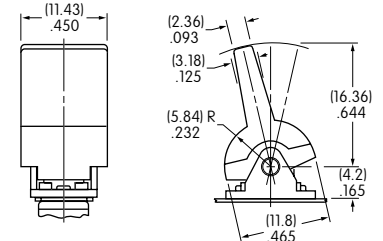

Cap Colors
Available:



Black



White



Red



Yellow



Green



Blue



Gray

TYPICAL SWITCH DIMENSIONS

Straight PC • Bracket

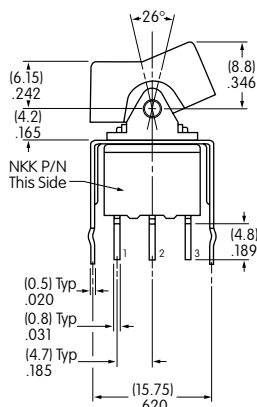

Single Pole

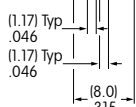
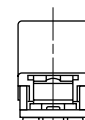

Double Pole

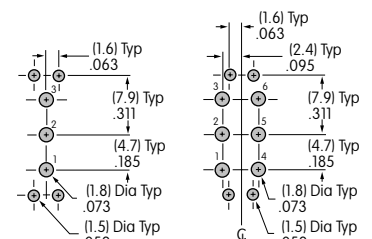
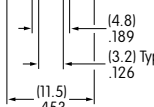
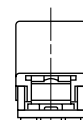

M2T12TXG13-DC

TYPICAL SWITCH DIMENSIONS

Right Angle PC

Single Pole

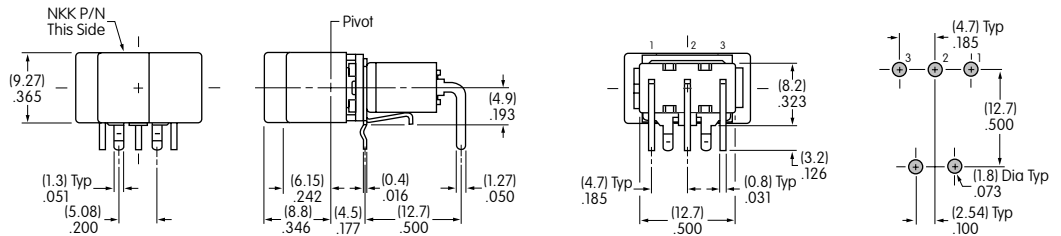

M2T12TXG30-DC

Right Angle PC

Double Pole

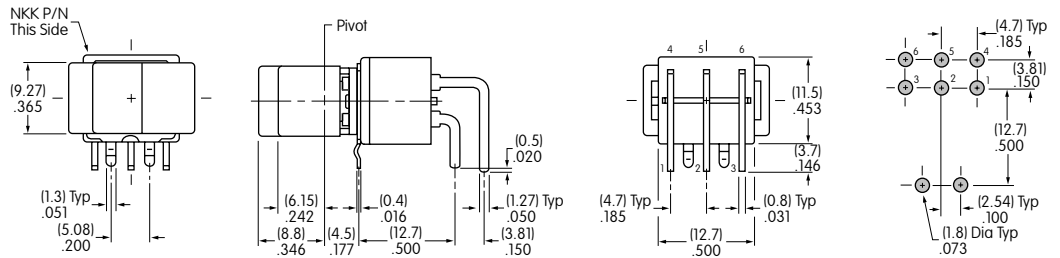

M2T22TXG30-DC

Vertical PC

Single Pole

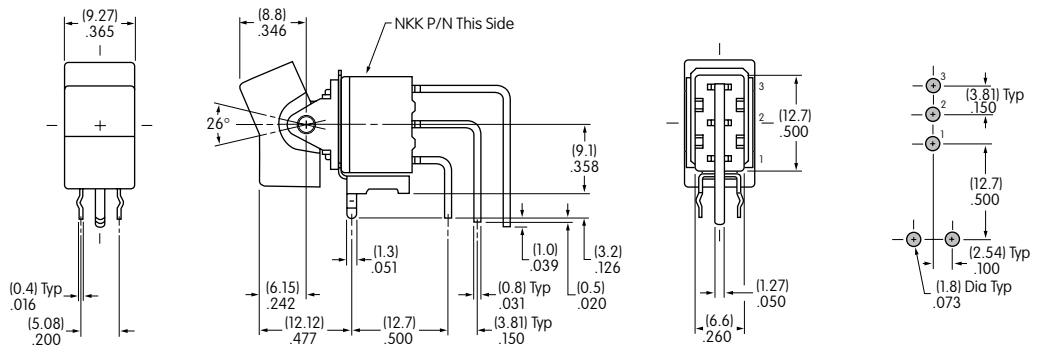

M2T12TXG41-DC

Vertical PC

Double Pole

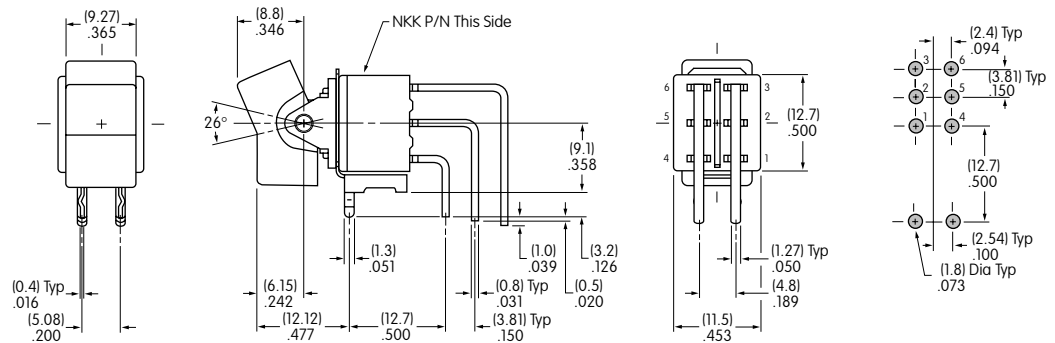

M2T22TXG41-DC

LEGENDS

General information and basic specifications are presented here for customers who want to do their own legends.

Suggested Printable Area for Cap

AT4148

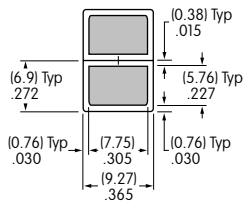

AT4150

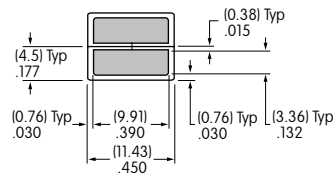

Shaded areas are printable areas.

Recommended Print Method:

Screen Print or Pad Print

Epoxy based ink is recommended.

Additional Method

An additional method for legends is engraving the cap. Maximum depth for engraving is .012" (0.3mm) on the cap. Enamel paint is recommended to fill the engraved area.

LEGEND PACKET

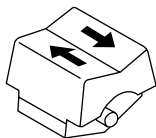

1. To order caps with legends contact the factory and request the M2T Rocker Legend Packet.
2. Once you determine your desired legend, fill out the ordering work sheet included in the packet.
3. Return the completed work sheet to receive a quotation.



Стандарт Электрон Связь

Мы молодая и активно развивающаяся компания в области поставок электронных компонентов. Мы поставляем электронные компоненты отечественного и импортного производства напрямую от производителей и с крупнейших складов мира.

Благодаря сотрудничеству с мировыми поставщиками мы осуществляем комплексные и плановые поставки широчайшего спектра электронных компонентов.

Собственная эффективная логистика и склад в обеспечивает надежную поставку продукции в точно указанные сроки по всей России.

Мы осуществляем техническую поддержку нашим клиентам и предпродажную проверку качества продукции. На все поставляемые продукты мы предоставляем гарантию .

Осуществляем поставки продукции под контролем ВП МО РФ на предприятия военно-промышленного комплекса России , а также работаем в рамках 275 ФЗ с открытием отдельных счетов в уполномоченном банке. Система менеджмента качества компании соответствует требованиям ГОСТ ISO 9001.

Минимальные сроки поставки, гибкие цены, неограниченный ассортимент и индивидуальный подход к клиентам являются основой для выстраивания долгосрочного и эффективного сотрудничества с предприятиями радиоэлектронной промышленности, предприятиями ВПК и научно-исследовательскими институтами России.

С нами вы становитесь еще успешнее!

Наши контакты:

Телефон: +7 812 627 14 35

Электронная почта: sales@st-electron.ru

Адрес: 198099, Санкт-Петербург,
Промышленная ул, дом № 19, литера Н,
помещение 100-Н Офис 331