

Features and Benefits

- Programmable high speed current sensor
- Tria[®]is[®] Technology
- Very high sensitivity due to Integrated Magnetic Concentrator (IMC-Hall[®])
- Wideband: DC to 200kHz
- Very short response time: 3μs
- Programmable linear transfer characteristic
- Selectable analog ratiometric output
- SO-8 package, RoHS compliant
- Lead free component, suitable for lead free soldering profile 260°C (target), MSL3

Application Examples

- Inverter HEV and EV
- BLDC motor current monitoring
- Smart fuse (over-current detection)
- AC/DC Converter
- DC/AC Converter (Inverter)
- DC/DC switched mode power supply

Ordering Information

| Part No. | Temperature Code | Package | Option code | Packing Form | Sensitivity Range (Default) |
|----------|--------------------|-----------|----------------------|-------------------|-----------------------------|
| MLX91208 | L (-40°C to 150°C) | DC (SOIC) | CAL-000 (low field) | TU/RE (tube/reel) | 100-700mV/mT (250mV/mT) |
| MLX91208 | L (-40°C to 150°C) | DC (SOIC) | CAH-000 (high field) | TU/RE (tube/reel) | 50-300mV/mT (100mV/mT) |
| MLX91208 | L (-40°C to 150°C) | DC (SOIC) | CAV-000 (v. high f.) | TU/RE (tube/reel) | 30-200mV/mT (40mV/mT) |
| MLX91208 | L (-40°C to 150°C) | DC (SOIC) | CAV-001 (v. high f.) | TU/RE (tube/reel) | 30-200mV/mT (60mV/mT) |

Ordering example: MLX91208LDC-CAH-000-RE

1 Functional Diagram

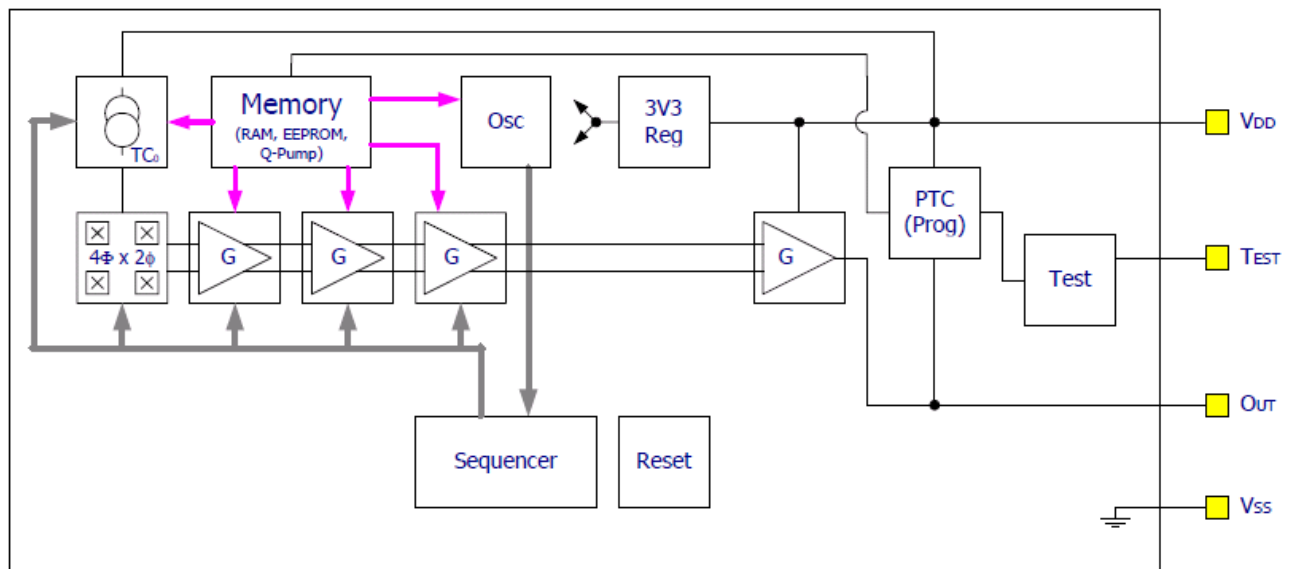

Figure 1: Block diagram

2 General Description

The MLX91208 is a monolithic sensor IC featuring the Tria[⊗]is™ Hall technology. Conventional planar Hall technology is only sensitive to the flux density applied orthogonally to the IC surface. The IMC-Hall[®] current sensor is sensitive to the flux density applied parallel to the IC surface. This is obtained through an Integrated Magneto-Concentrator (IMC-Hall[®]) which is deposited on the CMOS die (as an additional back-end step). The IMC-Hall[®] technology is automotive qualified.

The product is a single chip Hall sensor which provides an output signal proportional to the flux density applied horizontally and is therefore suitable for current measurement. It is ideally suited as an open loop current sensor for PCB or bus bar mounting. It features small size application design and a simple construction for various current ranges from few Amperes up to 1000 Amperes.

The transfer characteristic of the MLX91208 is programmable in terms of offset, gain or temperature compensation. The linear analog output is designed for applications where a very fast response is required, such as inverter applications.

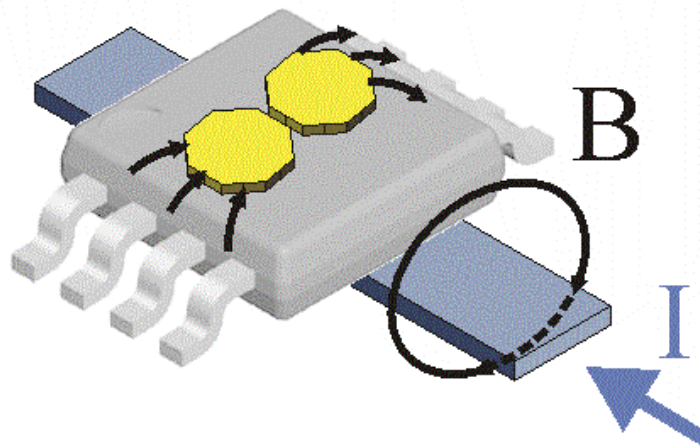

Figure 2: Typical application of MLX91208

Table of Contents

| | | |
|----|---|----|
| 1 | Functional Diagram..... | 1 |
| 2 | General Description..... | 2 |
| 3 | Glossary of Terms | 4 |
| 4 | Absolute Maximum Ratings | 4 |
| 5 | Pin Definitions and Descriptions | 4 |
| 6 | General Electrical Specifications..... | 5 |
| 7 | Magnetic specification | 6 |
| | 7.1 Low Field Version 10mT (marking xxL)..... | 6 |
| | 7.2 High Field Version 25mT (marking xxH) | 6 |
| | 7.3 Very High Field Version 60mT (marking xxV) | 6 |
| 8 | Analog output specification | 7 |
| | 8.1 Timing specification..... | 7 |
| | 8.2 Accuracy specification | 8 |
| | 8.3 Remarks to the achievable accuracy | 8 |
| 9 | Programmable items..... | 9 |
| | 9.1 Parameter table..... | 9 |
| | 9.2 Sensitivity programming (RG, FG)..... | 9 |
| | 9.3 Offset / output quiescent voltage programming (VOQ)..... | 9 |
| | 9.4 Output ratiometry (ENRATIO)..... | 9 |
| | 9.5 Sensitivity temperature drift programming (TC1ST, TC2ND_COLD, TC2ND_HOT)..... | 10 |
| | 9.6 Offset temperature drift programming (OFFDR2C, OFFDR2H)..... | 10 |
| | 9.7 Noise filter (NOISEFILT)..... | 10 |
| | 9.8 Identification code (ID)..... | 10 |
| 10 | Self diagnostic | 10 |
| 11 | Application information..... | 11 |
| | 11.1 Low current measurement ± 2 -10A..... | 11 |
| | 11.2 Medium current measurement up to ± 50 A..... | 11 |
| | 11.3 High current measurement up to ± 1000 A | 11 |
| 12 | Recommended Application Diagrams | 12 |
| | 12.1 Resistor and capacitor values..... | 12 |
| | 12.2 Pull down resistor for diagnostic low..... | 12 |
| | 12.3 Pull up resistor for diagnostic high..... | 12 |
| 13 | Typical performance | 13 |
| 14 | Standard information regarding manufacturability of Melexis products with different soldering processes | 14 |
| 15 | ESD Precautions | 14 |
| 16 | Package information | 15 |
| | 16.1 SOIC-8 Package Dimensions | 15 |
| | 16.2 SOIC-8 Pinout and Marking..... | 15 |
| | 16.3 SOIC-8 Hall plate position | 16 |
| | 16.4 SOIC-8 IMC Position and sensor active measurement dimension | 16 |
| 17 | Disclaimer..... | 18 |

3 Glossary of Terms

| | |
|-------|--|
| ADC | Analog to Digital Converter |
| DAC | Digital to Analog Converter |
| DNL | Differential Non Linearity |
| IMC | Integrated Magneto Concentrator (IMC-Hall [®]) |
| INL | Integral Non Linearity |
| LSB | Least Significant Bit |
| MSB | Most Significant Bit |
| NC | Not Connected |
| PTC | Programming Through Connector |
| TC | Temperature Coefficient in ppm/°C |
| Tesla | Units for the magnetic flux density, 1 mT = 10 Gauss |

4 Absolute Maximum Ratings

| Parameter | Symbol | Value | Units |
|--|------------------|-------------|-------|
| Positive Supply Voltage (overvoltage) | V _{dd} | +10 | V |
| Reverse Supply Voltage Protection | | -0.3 | V |
| Positive Output Voltage ⁽¹⁾ | | +10 | V |
| Output Current | I _{out} | ±70 | mA |
| Reverse Output Voltage | | -0.3 | V |
| Reverse Output Current | | -50 | mA |
| Package Thermal Resistance | R _{th} | 105 | °C/W |
| Operating Ambient Temperature Range | T _A | -40 to +150 | °C |
| Storage Temperature Range | T _s | -55 to +165 | °C |
| Magnetic Flux Density | | infinite | T |

Table 1: Absolute maximum ratings

Exceeding the absolute maximum ratings may cause permanent damage. Exposure to absolute maximum rated conditions for extended periods may affect device reliability.

(1) Valid for supply=10V or supply-pin floating

5 Pin Definitions and Descriptions

| Pin # | Name | Type | Function |
|-------|-----------|---------|------------------------------|
| 1 | VDEC | Digital | Digital Supply Voltage |
| 3 | VSS | Ground | Supply Voltage |
| 4 | TEST/MUST | Digital | Test and Factory Calibration |
| 5 | VDD | Supply | Supply Voltage |
| 6 | OUT | Analog | Current Sensor Output |

Table 2: Pin definition and description

It is recommended to connect unused pins to the Ground for optimal EMC results.

6 General Electrical Specifications

Operating Parameters: $T_A = -40^{\circ}\text{C}$ to 125°C , $V_{dd} = 4.5\text{V}$ to 5.5V , $I_{out} = -2\text{mA}$ to $+2\text{mA}$, recommended application diagram in section 1, unless otherwise specified. All mentioned component values can have a $\pm 20\%$ tolerance.

| Parameter | Symbol | Test Conditions | Min | Typ | Max | Units |
|---|-------------------------|---|------|-----|------|------------------|
| Nominal Supply Voltage | Vdd | | 4.5 | 5 | 5.5 | V |
| Supply Current | Idd | Without output load In application mode $T_A = -40^{\circ}\text{C}$ to 150°C | 7 | 12 | 14 | mA |
| DC Load Current | Iout | R_{load} in range [6k Ω , 100k Ω] | -2 | | 2 | mA |
| Maximum Output Current (driving capability) | I _{max} | Inside this range, output voltage reaches 3%V _{dd} and 97%V _{dd} | -2 | | 2 | mA |
| Output Resistance | | $V_{out} = 50\% V_{dd}$, $R_L = 10\text{k}\Omega$ | | 1 | 5 | Ω |
| Output Capacitive Load | C _{load} | Capacitive load range for the stability of the output amplifier. Output amplifier optimized for the typical capacitive load. | 1 | 2 | 10 | nF |
| Output Resistive Load | R _{load} | Output resistive load for high linearity (both pull-up and pull-down resistor) | 6 | | | k Ω |
| Output Short Circuit Current | I _{short} | Output shorted to V _{dd} (Permanent) | 35 | | 180 | mA |
| | | Output shorted to V _{ss} (Permanent) | 35 | | 180 | mA |
| Output Leakage current | I _{leak} | High impedance mode ⁽¹⁾ $T = 150^{\circ}\text{C}$ | 0.5 | 1.5 | 20 | μA |
| Output Voltage Swing (Linear Range) | V _{out_pd} | pull down $\geq 10\text{ k}\Omega$ | 10 | | 90 | %V _{dd} |
| | V _{out_pu} | pull up $\geq 10\text{ k}\Omega$ | 10 | | 90 | %V _{dd} |
| High-impedance mode levels ⁽¹⁾ | V _{out_HiZ_pu} | pull-up $R_L \leq 25\text{ k}\Omega$, $T \leq 125^{\circ}\text{C}$ | 95 | | | %V _{dd} |
| | V _{out_HiZ_pd} | pull-down $R_L \leq 25\text{ k}\Omega$, $T \leq 125^{\circ}\text{C}$ | | | 5 | %V _{dd} |
| Under-voltage detection ⁽²⁾ | V _{dd_uvd} | Low to High Voltage | 3 | 3.3 | 4 | V |
| | V _{dd_uvh} | Hysteresis | 0.25 | 0.3 | 0.4 | V |
| Over-voltage detection ⁽²⁾ | V _{dd_ovd2} | Low to High Voltage | 6.7 | | 7.6 | V |
| | V _{dd_ovh2} | Hysteresis | 0.05 | | 0.7 | V |
| Ratiometry enable detection ⁽²⁾ | V _{ratio_d} | Low to High Voltage | 4 | | 4.45 | V |
| | V _{ratio_h} | Hysteresis | 0.05 | | 0.5 | V |

Table 3: General electrical parameter

- (1) Refer to chapter *Self diagnostic*, Table 10.
- (2) According to figure on the right:

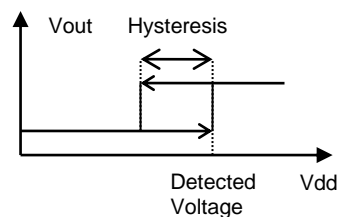

7 Magnetic specification

Operating Parameters $T_A = -40^{\circ}\text{C}$ to 125°C , $V_{dd} = 4.5\text{V}$ to 5.5V , unless otherwise specified.

7.1 Low Field Version 10mT (marking xxL)

| Parameter | Symbol | Test Conditions | Min | Typ | Max | Units |
|--|--------|--|------|-----|------|-------|
| Nominal Magnetic field range | Bnom | | -7.5 | | +7.5 | mT |
| Operational Field Range ⁽¹⁾ | Bop | | -10 | | +10 | mT |
| Linearity Error | NL | B in range Bop Vout in [10%Vdd, 90%Vdd] | -0.7 | | +0.7 | %FS |
| Hysteresis | Br | B = Bop | -10 | | +10 | uT |
| Programmable Sensitivity | S | | 100 | 250 | 700 | mV/mT |
| Sensitivity programming Resolution | Sres | | | 0.1 | | % |

Table 4: Magnetic specification for 10mT version (low field)

7.2 High Field Version 25mT (marking xxH)

| Parameter | Symbol | Test Conditions | Min | Typ | Max | Units |
|--|--------|--|------|-----|------|-------|
| Nominal Magnetic field range | Bnom | | -20 | | +20 | mT |
| Operational Field Range ⁽¹⁾ | Bop | | -25 | | +25 | mT |
| Linearity Error | NL | B in range Bop Vout in [10%Vdd, 90%Vdd] | -0.7 | | +0.7 | %FS |
| Hysteresis | Br | B = Bop | -25 | | +25 | uT |
| Programmable Sensitivity | S | | 50 | 100 | 300 | mV/mT |
| Sensitivity programming Resolution | Sres | | | 0.1 | | % |

Table 5: Magnetic specification for 25mT version (high field)

7.3 Very High Field Version 60mT (marking xxV)

| Parameter | Symbol | Test Conditions | Min | Typ | Max | Units |
|--|--------|--|----------|----------|------------|----------------|
| Nominal Magnetic field range | Bnom | | -50 | | +50 | mT |
| Operational Field Range ⁽¹⁾ | Bop | | -60 | | +60 | mT |
| Linearity Error | NL | B in range Bop Vout in [10%Vdd, 90%Vdd] | -0.7 | | +0.7 | %FS |
| Hysteresis | Br | B = Bop | -50 | | +50 | uT |
| Programmable Sensitivity | S | CAV-000 CAV-001 | 30 30 | 40 60 | 200 200 | mV/mT mV/mT |
| Sensitivity programming Resolution | Sres | | | 0.1 | | % |

Table 6: Magnetic specification for 60mT version (very high field)

(1) Outside Bop, the IMC progressively enters saturation, yielding to an increase of the linearity error.

8 Analog output specification

8.1 Timing specification

Operating Parameters $T_A = -40^{\circ}\text{C}$ to 125°C , $V_{dd} = 4.5\text{V}$ to 5.5V (unless otherwise specified).

| Parameter | Symbol | Test Conditions / Comments | Min | Typ | Max | Units |
|------------------------------|-------------|--|-----|-----|-----|---------------|
| Refresh rate | T_{rr} | | 0.8 | 1 | 2 | μs |
| Step Response Time | T_{resp} | Delay between the input signal reaching 90% and the output signal reaching 90%, (2V step at the output, input rise time = $1\mu\text{s}$) | | | | |
| | | -Noise filter OFF | | 3 | 4 | μs |
| | | -Noise filter ON | | 5 | 6 | μs |
| Bandwidth | BW | -Noise filter OFF | 200 | 250 | 300 | kHz |
| | | -Noise filter ON | 120 | 150 | 180 | kHz |
| Power on Delay | T_{POD} | $V_{out} = 100\%$ of FS Pull-down resistor $\leq 100\text{k}\Omega$ During the Power-on delay, the output will remain within the 10% fault band at all time. | | | 1 | ms |
| Ratiometry Cut-off Frequency | F_{ratio} | | | 250 | | Hz |

Table 7: Timing specification for high speed analog output

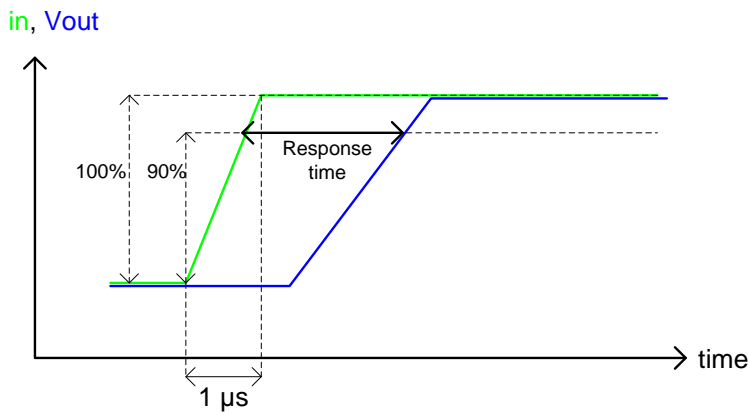

Figure 4: Response time definition

8.2 Accuracy specification

Operating Parameters $T_A = -40^{\circ}\text{C}$ to 125°C , $V_{dd} = 4.5\text{V}$ to 5.5V (unless otherwise specified).

| Parameter | Symbol | Test Conditions | Min | Typ | Max | Units |
|--------------------------------------|-------------------------|---|------|-------|-------------|--------------------------------------|
| Thermal Offset Drift | $\Delta^T\text{Voq}$ | Offset drift referred to 25°C $S=40\text{mV/mT}$ (xxV version) $S=100\text{mV/mT}$ (xxH version) $S=250\text{mV/mT}$ (xxL version) $V_{dd}=5\text{V}$ $\text{TC}=0\pm 150\text{ ppm}/^{\circ}\text{C}$ $\text{Voq}=50\pm 0.2\%V_{dd}$ | -10 | | +10 | mV |
| Thermal Offset Drift Resolution | $\Delta^T\text{VoqRes}$ | | | 0.075 | | mV/ $^{\circ}\text{C}$ |
| Thermal Sensitivity Drift | TC | | -1.5 | 0 | +1.5 | % of S |
| Thermal Sensitivity Drift Resolution | TCres | | | 40 | | ppm/ $^{\circ}\text{C}$ |
| RMS Output noise | N_{rms} | $S=40\text{mV/mT}$ (xxV version) $S=100\text{mV/mT}$ (xxH version) $S=250\text{mV/mT}$ (xxL version) -Noise filter OFF -Noise filter ON | | | 0.2 0.12 | %V _{dd} %V _{dd} |
| Ratiometry Error Offset | ΔVoq | $\text{Voq} = 50\%V_{dd}$ $\Delta V_{dd} = 10\%V_{dd}$ | -0.4 | | +0.4 | % of Voq |
| Ratiometry Error Sensitivity | ΔS | $\Delta V_{dd} = 10\%V_{dd}$ | -0.4 | | +0.4 | % of S |

Table 8: Accuracy-Specific Parameters

8.3 Remarks to the achievable accuracy

The achievable target accuracy depends on the user end of line calibration. The resolution for the offset and offset drift calibration is better than $0.1\%V_{dd}$. Trimming capability is higher than measurement accuracy. End user calibration can increase the accuracy of the system.

9 Programmable items

9.1 Parameter table

| Parameter | Bits | Comment |
|--------------|------|--|
| VOQ[11:0] | 12 | Quiescent output level (0 Gauss) adjustment |
| RG[2:0] | 3 | Rough gain adjustment |
| FG[9:0] | 10 | Fine gain adjustment |
| ENRATIO | 1 | Ratiometry enablement |
| TC1[7:0] | 8 | Adjustment of the first order temperature compensation of the magnetic sensitivity |
| TC2HOT[4:0] | 5 | Adjustment of the extra temperature compensation of the magnetic sensitivity at high temperature |
| TC2COLD[4:0] | 5 | Adjustment of the extra temperature compensation of the magnetic sensitivity at low temperature |
| OFFDR2C[5:0] | 6 | Adjustment of the offset drift at low temperature after the VGA |
| OFFDR2H[5:0] | 6 | Adjustment of the offset drift at high temperature after the VGA |
| NOISEFILT | 1 | Noise filter enablement |
| CRC[15:0] | 16 | 16-bit CRC for the checksum calculation of the configuration register. |
| ID[47:0] | 48 | Customer identification code |

Table 9: Customer programmable items

9.2 Sensitivity programming (RG, FG)

The sensitivity can be programmed from 50 to 300mV/mT (high field version) or 100 to 700mV/mT (low field version), with the ROUGHGAIN (3 bits) and FINEGAIN (10 bits) parameters.

9.3 Offset / output quiescent voltage programming (VOQ)

The offset is programmable with 12 bits in 1.5 mV steps over the full output range. This corresponds to a calibration resolution of 0.03 %VDD.

The typical step size would be $5V/4096 = 1.22$ mV, but the actual step size can differ from the nominal value because of internal gain tolerance. A maximum step size of 1.5 mV is guaranteed.

Note: for optimal performance over temperature, the VOQ should be programmed in the range from 2 to 3V.

9.4 Output ratiometry (ENRATIO)

The ratiometry of the output versus the supply can be disabled by setting this bit to 0.

Note: for optimal performance over temperature, the ratiometry setting should not be changed on customer side. By default, this setting is enabled during final test calibration.

9.5 Sensitivity temperature drift programming (TC1ST, TC2ND_COLD, TC2ND_HOT)

First order sensitivity temperature drift can be trimmed with TC1. The programming resolution is 40ppm/K. Second order sensitivity temperature drift can be trimmed with TC2COLD and TC2HOT. The programming resolution is 2ppm/K² for TC2COLD and 0.6ppm/K² for TC2HOT. The second order can also be seen as third order correction since cold and hot sides are independently adjusted.

Note: for optimal performance over temperature, the first order sensitivity drift compensation (TC1ST) should not exceed ± 250 ppm/K.

9.6 Offset temperature drift programming (OFFDR2C, OFFDR2H)

Offset temperature drift caused by the output amplifier can be compensated with these two parameters. This first order correction is done independently for temperatures over and below 25°C.

Note: Two additional parameters (OFFDR1C, OFFDR1H) are calibrated by Melexis to compensate for the offset temperature drift caused by the Hall element (before the variable gain amplifier). These parameters should not be adjusted on customer-side.

9.7 Noise filter (NOISEFILT)

Setting this bit to 1 enables the noise filter, reducing noise and increasing response time.

9.8 Identification code (ID)

48 bits programmable identification code.

10 Self diagnostic

The MLX91208 provides self diagnostic features to detect internal memory errors and over- / under-voltage. Those features increase the robustness of the IC functionality, as they prevent the IC from providing erroneous output signal in case of internal or external failure modes.

| Error | Action | Effect on Outputs | Remarks |
|---|-------------|---------------------|---|
| Calibration Data CRC Error (at power up and in normal working mode) | Fault mode | High Impedance mode | Pull down resistive load => Diag Low Pull up resistive load => Diag High |
| Power On delay | | High Impedance mode | 5ms max in high impedance followed by settling |
| Undervoltage Mode | IC is reset | High Impedance mode | 300mV Hysteresis (typical) |
| Overvoltage detection | IC is reset | High Impedance mode | 100mV Hysteresis (typical) |

Table 10: Self diagnostic

11 Application information

Please refer to our current sensor reference design guide for more application information:
<http://melexis.com/Assets/Current-Sensors-Reference-Designs-6187.aspx>

11.1 Low current measurement $\pm 2-10A$

Low currents can be measured by either using a multi-turn/multi-layer PCB where the current is allowed to flow several times under the sensor, or by adding a closed ferromagnetic shield around the current trace with a small air gap to concentrate the magnetic flux above the sensor.

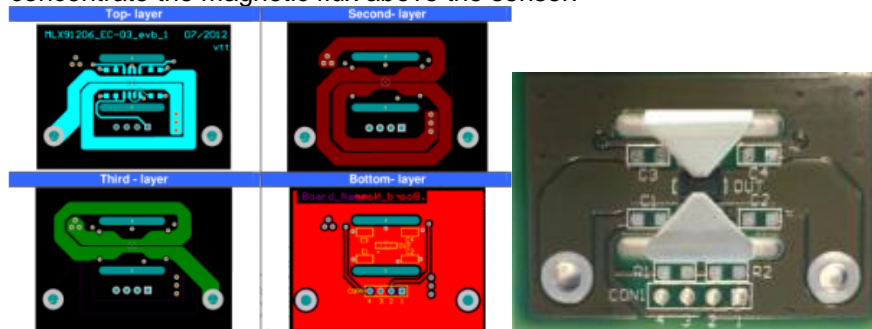

Figure 3: Low current applications with either multi-trace/multi-layer PCB (left) or closed shield (right).

11.2 Medium current measurement up to $\pm 50A$

For medium currents, a single PCB trace can be used. The sizing of the PCB trace should take into account the current handling capability and the total power dissipation. The PCB trace should be thick and wide enough to handle the RMS current continuously.

A simple “U-shaped” ferromagnetic shield is often required to protect the sensor from cross-talk or external stray fields, if they cannot be cancelled-out by other means (peak-peak detection, etc.).

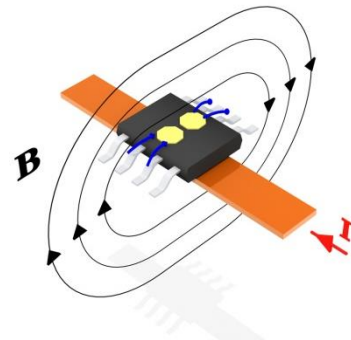

Figure 4: Medium current application on PCB

11.3 High current measurement up to $\pm 1000A$

For high currents flowing in a bus bar, MLX91208 is typically assembled on a PCB lying immediately above the current conductor.

A ferromagnetic shield is usually added to protect the sensor from external fields and ensure good homogeneity of the magnetic flux, for optimal robustness against vibrations and mechanical tolerances.

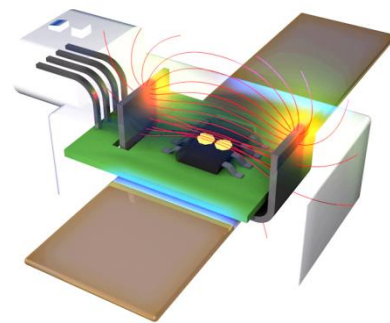

Figure 5: High current application on bus bar

12 Recommended Application Diagrams

12.1 Resistor and capacitor values

| Part | Description | Value | Unit |
|------|-------------------------------|---------------------|------------|
| C1 | Supply capacitor, EMI, ESD | 100 | nF |
| C2 | Decoupling, EMI, ESD | 2-10 ⁽¹⁾ | nF |
| C3 | Decoupling, EMI, ESD | 47 | nF |
| R1 | Pull up or pull down resistor | 6-100 | k Ω |

Table 11: Resistor and capacitor values

(1) 10nF is recommended for better EMC and ESD performance.

12.2 Pull down resistor for diagnostic low

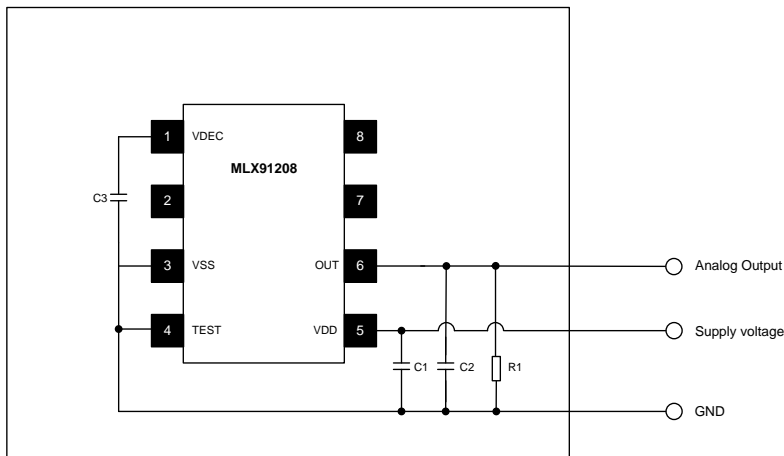

Figure 6: Diagnostic low

12.3 Pull up resistor for diagnostic high

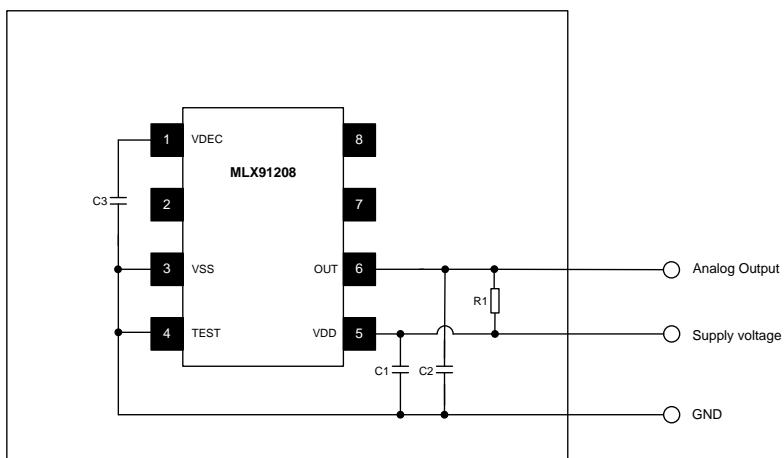

Figure 7: Diagnostic high

13 Typical performance

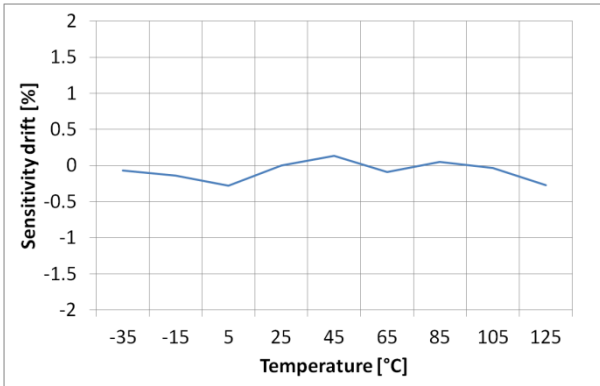

Figure 8: Thermal sensitivity drift.

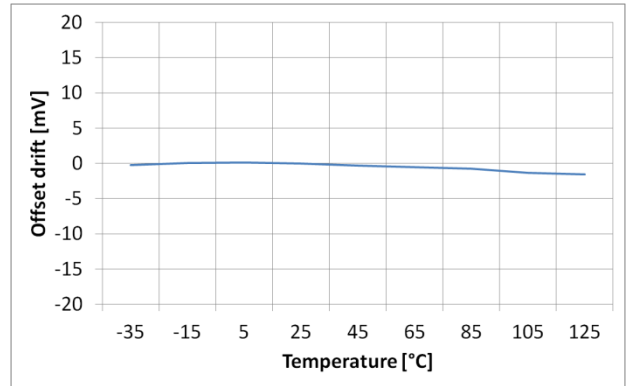

Figure 9: Thermal offset drift.

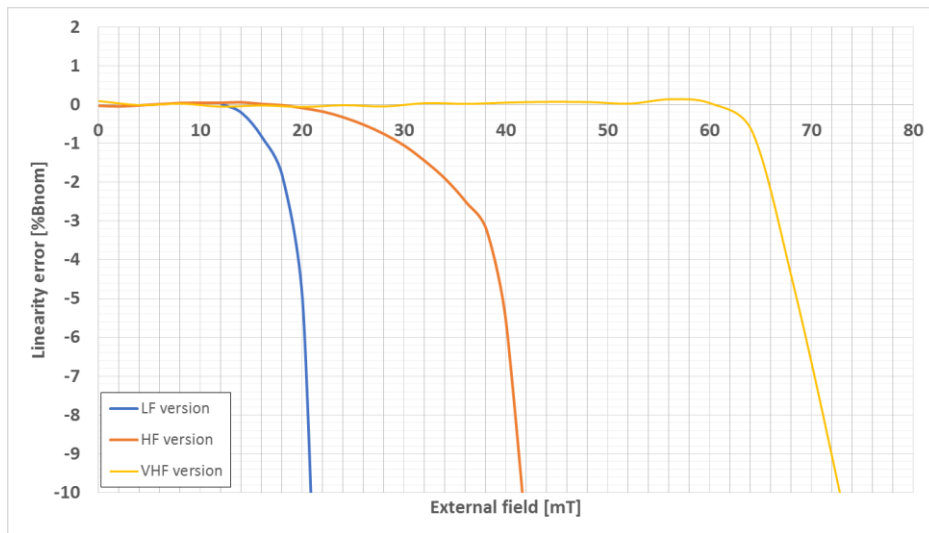

Figure 10: Linearity error for all versions.



Figure 11: Response time with noise filter OFF.

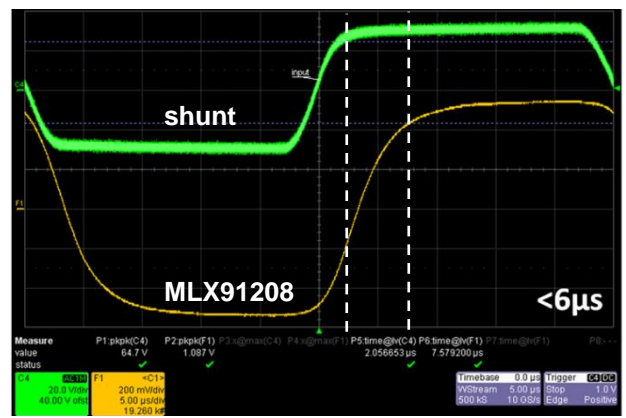

Figure 12: Response time with noise filter ON.

14 Standard information regarding manufacturability of Melexis products with different soldering processes

Melexis devices are qualified using state-of-the-art practices in accordance with automotive and environmental requirements.

Through qualifications, various soldering techniques are considered; please refer to “Soldering recommendations for Melexis products” for more information:

http://www.melexis.com/Asset/Soldering_Application_Note_and_Recommendations_DownloadLink_5446.aspx).

For components normally soldered using Surface Mounted Device techniques (eg: Reflow process), Melexis has defined and qualified Moisture Sensitivity Level and Peak Temperature in accordance with the Jedec J-STD-020 standard. Delivered material is conditioned accordingly. Moisture Sensitivity Level and Peak Temperature information can be found on the label identifying the material.

In case you intend to use a reflow soldering process for through hole devices (Melexis’ package codes: SA, UA, VA, VK, VM), please contact Melexis to verify your soldering process compatibility.

The application of Wave Soldering for SMD’s is allowed only after consulting Melexis regarding assurance of adhesive strength between device and board.

Based on Melexis commitment to environmental responsibility, Europe legislations (Direction on the Restriction of the Use of Certain Hazardous substances, RoHS) and customer requests, Melexis has deployed Pb free leadfinish (typically Matte Tin) on all ASSP products.

For through hole devices (Melexis’ package codes: SA, UA, VA, VK, VM) Trim&Form, please refer to “Trim & Form recommendations for Melexis products” for more information:

http://www.melexis.com/Assets/Trim_and_form_recommendations_DownloadLink_5565.aspx

15 ESD Precautions

Electronic semiconductor products are sensitive to Electro Static Discharge (ESD).

Always observe Electro Static Discharge control procedures whenever handling semiconductor products.

ESD HBM robustness is 2kV on external pins according to AEC-Q100-002 REV-D.

16 Package information

16.1 SOIC-8 Package Dimensions

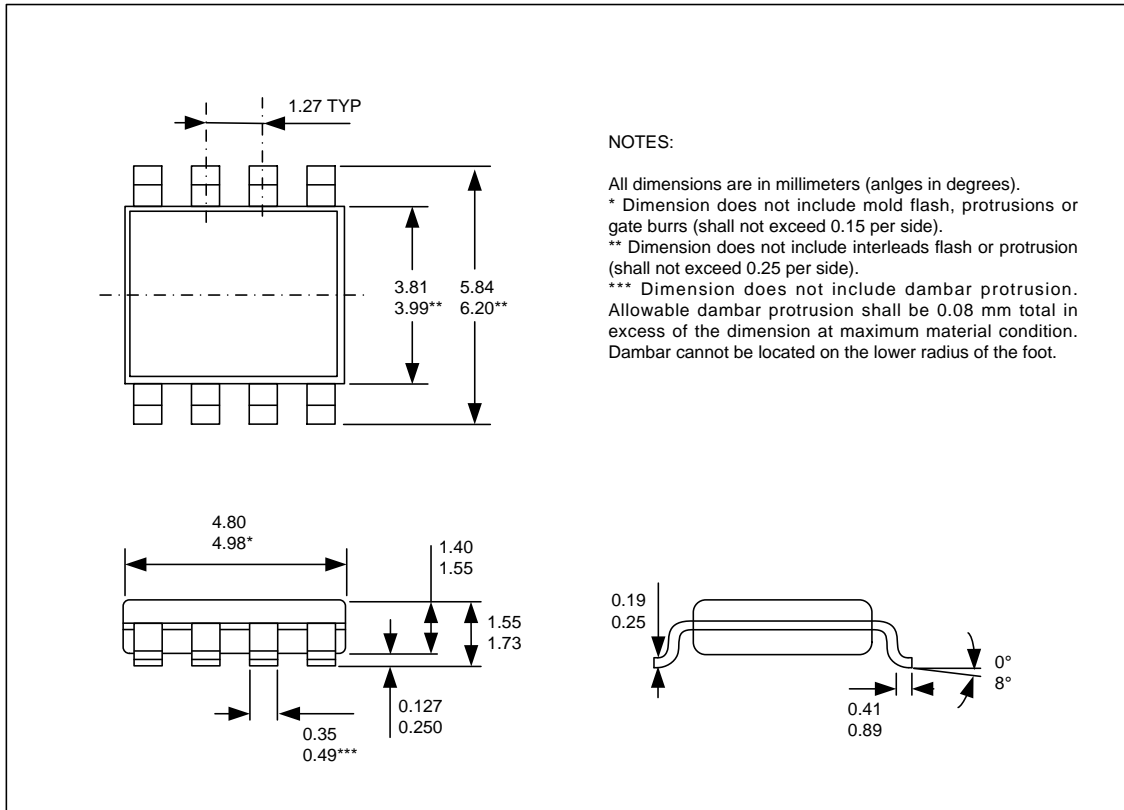

Figure 13: SOIC-8 Package dimensions

16.2 SOIC-8 Pinout and Marking

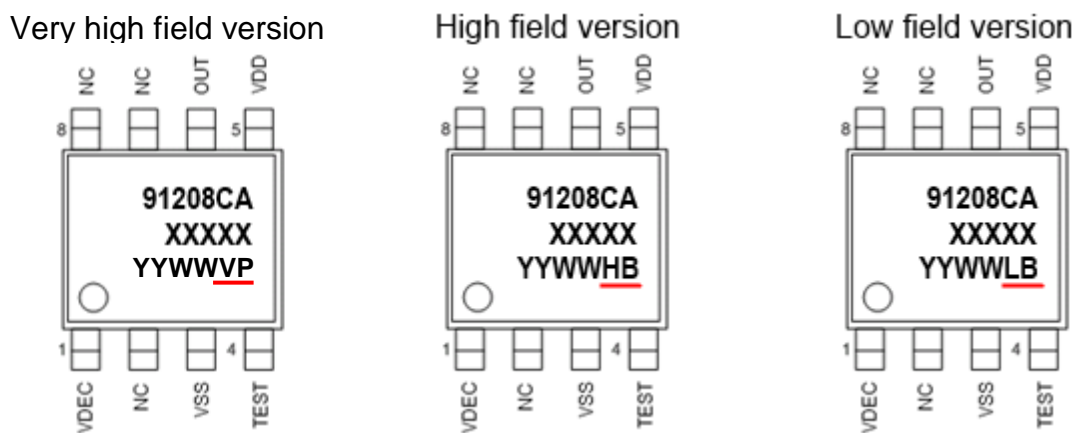

Figure 14: SOIC-8 Pinout and marking (Very High Field, High Field and Low Field version)

16.3 SOIC-8 Hall plate position

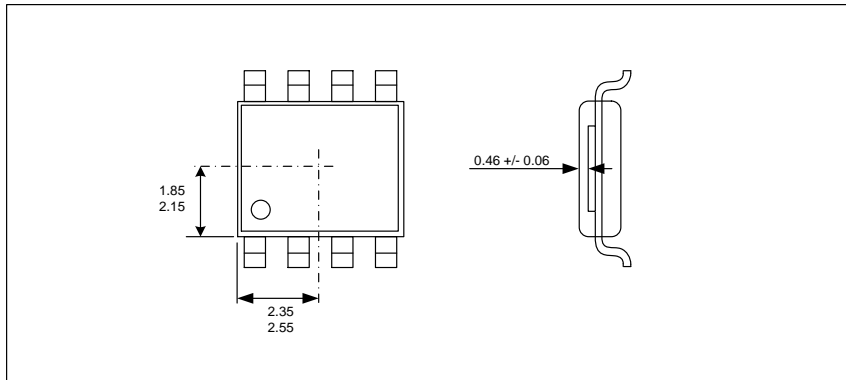

Figure 15: SOIC-8 Hall Plate positioning

16.4 SOIC-8 IMC Position and sensor active measurement dimension

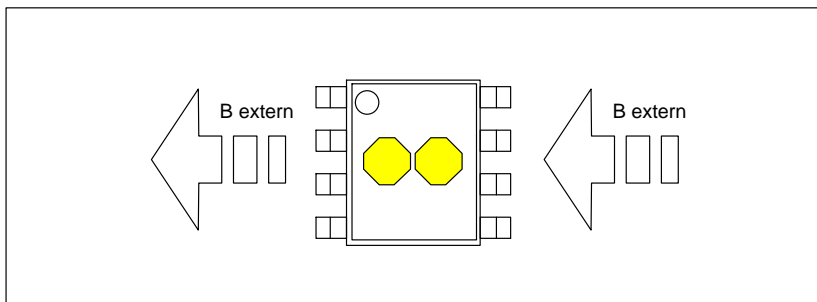

Figure 16: IMC position and geometry for low-field version

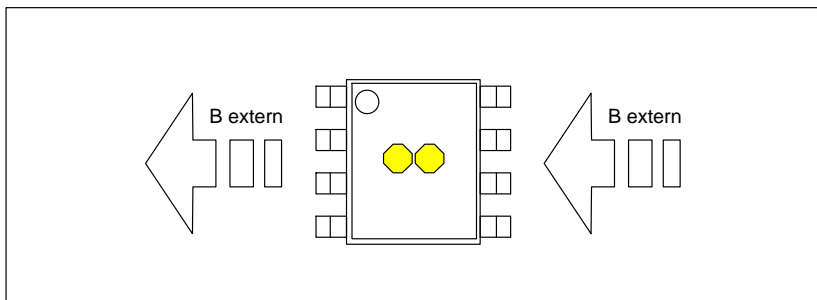

Figure 17: IMC position and geometry high-field version

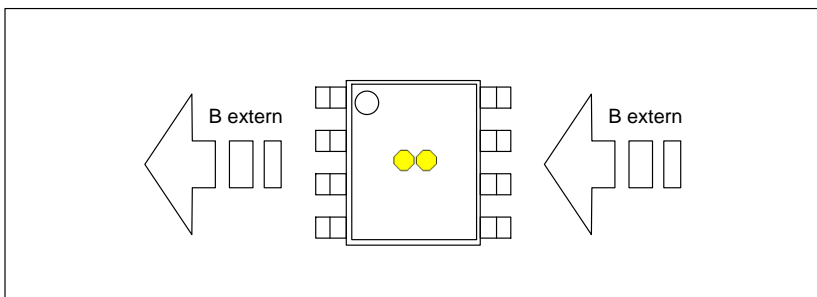

Figure 18: IMC position and geometry very high-field version

Disclaimer

Devices sold by Melexis are covered by the warranty and patent indemnification provisions appearing in its Term of Sale. Melexis makes no warranty, express, statutory, implied, or by description regarding the information set forth herein or regarding the freedom of the described devices from patent infringement. Melexis reserves the right to change specifications and prices at any time and without notice. Therefore, prior to designing this product into a system, it is necessary to check with Melexis for current information. This product is intended for use in normal commercial applications. Applications requiring extended temperature range, unusual environmental requirements, or high reliability applications, such as military, medical life-support or life-sustaining equipment are specifically not recommended without additional processing by Melexis for each application.

The information furnished by Melexis is believed to be correct and accurate. However, Melexis shall not be liable to recipient or any third party for any damages, including but not limited to personal injury, property damage, loss of profits, loss of use, interrupt of business or indirect, special incidental or consequential damages, of any kind, in connection with or arising out of the furnishing, performance or use of the technical data herein. No obligation or liability to recipient or any third party shall arise or flow out of Melexis' rendering of technical or other services.

© 2009 Melexis NV. All rights reserved.

For the latest version of this document, go to our website at
www.melexis.com

Or for additional information contact Melexis Direct:

| | |
|--|--|
| Europe, Africa, Asia: | America: |
| Phone: +32 1367 0495 | Phone: +1 603 223 2362 |
| E-mail: sales_europe@melexis.com | E-mail: sales_usa@melexis.com |

ISO/TS 16949 and ISO14001 Certified



Стандарт Электрон Связь

Мы молодая и активно развивающаяся компания в области поставок электронных компонентов. Мы поставляем электронные компоненты отечественного и импортного производства напрямую от производителей и с крупнейших складов мира.

Благодаря сотрудничеству с мировыми поставщиками мы осуществляем комплексные и плановые поставки широчайшего спектра электронных компонентов.

Собственная эффективная логистика и склад в обеспечивает надежную поставку продукции в точно указанные сроки по всей России.

Мы осуществляем техническую поддержку нашим клиентам и предпродажную проверку качества продукции. На все поставляемые продукты мы предоставляем гарантию .

Осуществляем поставки продукции под контролем ВП МО РФ на предприятия военно-промышленного комплекса России , а также работаем в рамках 275 ФЗ с открытием отдельных счетов в уполномоченном банке. Система менеджмента качества компании соответствует требованиям ГОСТ ISO 9001.

Минимальные сроки поставки, гибкие цены, неограниченный ассортимент и индивидуальный подход к клиентам являются основой для выстраивания долгосрочного и эффективного сотрудничества с предприятиями радиоэлектронной промышленности, предприятиями ВПК и научно-исследовательскими институтами России.

С нами вы становитесь еще успешнее!

Наши контакты:

Телефон: +7 812 627 14 35

Электронная почта: sales@st-electron.ru

Адрес: 198099, Санкт-Петербург,
Промышленная ул, дом № 19, литера Н,
помещение 100-Н Офис 331