

MJD31, NJVMJD31T4G, MJD31C, NJVMJD31CT4G (NPN), MJD32, NJVMJD32T4G, MJD32C, NJVMJD32CG, NJVMJD32CT4G (PNP)



ON Semiconductor®

<http://onsemi.com>

Complementary Power Transistors

DPAK For Surface Mount Applications

Designed for general purpose amplifier and low speed switching applications.

Features

- Lead Formed for Surface Mount Applications in Plastic Sleeves
- Straight Lead Version in Plastic Sleeves ("1" Suffix)
- Lead Formed Version in 16 mm Tape and Reel ("T4" Suffix)
- Electrically Similar to Popular TIP31 and TIP32 Series
- Epoxy Meets UL 94, V-0 @ 0.125 in
- ESD Ratings:
 - ♦ Human Body Model, 3B > 8000 V
 - ♦ Machine Model, C > 400 V
- NJV Prefix for Automotive and Other Applications Requiring Unique Site and Control Change Requirements; AEC-Q101 Qualified and PPAP Capable
- These are Pb-Free Packages*

**SILICON
POWER TRANSISTORS
3 AMPERES
40 AND 100 VOLTS
15 WATTS**



**DPAK
CASE 369C
STYLE 1**

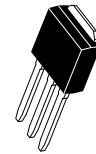

**DPAK-3
CASE 369D
STYLE 1**

MARKING DIAGRAMS

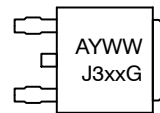

DPAK

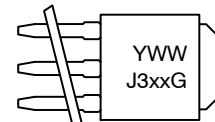

DPAK-3

A = Site Code
Y = Year
WW = Work Week
xx = 1, 1C, 2, or 2C
G = Pb-Free Package

ORDERING INFORMATION

See detailed ordering and shipping information in the package dimensions section on page 9 of this data sheet.

*For additional information on our Pb-Free strategy and soldering details, please download the ON Semiconductor Soldering and Mounting Techniques Reference Manual, SOLDERRM/D.

**MJD31, NJVMJD31T4G, MJD31C, NJVMJD31CT4G (NPN), MJD32, NJVMJD32T4G,
MJD32C, NJVMJD32CG, NJVMJD32CT4G (PNP)**

MAXIMUM RATINGS

| Rating | Symbol | Max | Unit |
|---|----------------|---------------|--------------------------|
| Collector–Emitter Voltage MJD31, NJVMJD31T4G, MJD32, NJVMJD32T4G MJD31C, NJVMJD31CT4G, MJD32C, NJVMJD32CG, NJVMJD32CT4G | V_{CEO} | 40 100 | Vdc |
| Collector–Base Voltage MJD31, NJVMJD31T4G, MJD32, NJVMJD32T4G MJD31C, NJVMJD31CT4G, MJD32C, NJVMJD32CG, NJVMJD32CT4G | V_{CB} | 40 100 | Vdc |
| Emitter–Base Voltage | V_{EB} | 5 | Vdc |
| Collector Current Continuous Peak | I_C | 3 5 | Adc |
| Base Current | I_B | 1 | Adc |
| Total Power Dissipation @ $T_C = 25^\circ\text{C}$ Derate above 25°C | P_D | 15 0.12 | W W/ $^\circ\text{C}$ |
| Total Power Dissipation @ $T_A = 25^\circ\text{C}$ Derate above 25°C | P_D | 1.56 0.012 | W W/ $^\circ\text{C}$ |
| Operating and Storage Junction Temperature Range | T_J, T_{stg} | -65 to +150 | $^\circ\text{C}$ |

Stresses exceeding Maximum Ratings may damage the device. Maximum Ratings are stress ratings only. Functional operation above the Recommended Operating Conditions is not implied. Extended exposure to stresses above the Recommended Operating Conditions may affect device reliability.

THERMAL CHARACTERISTICS

| Characteristic | Symbol | Max | Unit |
|--|-----------------|-----|---------------------------|
| Thermal Resistance, Junction–to–Case | $R_{\theta JC}$ | 8.3 | $^\circ\text{C}/\text{W}$ |
| Thermal Resistance, Junction–to–Ambient* | $R_{\theta JA}$ | 80 | $^\circ\text{C}/\text{W}$ |
| Lead Temperature for Soldering Purposes | T_L | 260 | $^\circ\text{C}$ |

*These ratings are applicable when surface mounted on the minimum pad sizes recommended.

**MJD31, NJVMJD31T4G, MJD31C, NJVMJD31CT4G (NPN), MJD32, NJVMJD32T4G,
MJD32C, NJVMJD32CG, NJVMJD32CT4G (PNP)**

ELECTRICAL CHARACTERISTICS ($T_C = 25^\circ\text{C}$ unless otherwise noted)

| Characteristic | Symbol | Min | Max | Unit |
|----------------|--------|-----|-----|------|
|----------------|--------|-----|-----|------|

OFF CHARACTERISTICS

| | | | | |
|--|----------------|-----------|----------|-----------------|
| Collector–Emitter Sustaining Voltage (Note 1) ($I_C = 30\text{ mAdc}$, $I_B = 0$) MJD31, NJVMJD31T4G, MJD32, NJVMJD32T4G MJD31C, NJVMJD31CT4G, MJD32C, NJVMJD32CG, NJVMJD32CT4G | $V_{CEO(sus)}$ | 40 100 | – – | Vdc |
| Collector Cutoff Current ($V_{CE} = 40\text{ Vdc}$, $I_B = 0$) MJD31, NJVMJD31T4G, MJD32, NJVMJD32T4G ($V_{CE} = 60\text{ Vdc}$, $I_B = 0$) MJD31C, NJVMJD31CT4G, MJD32C, NJVMJD32CG, NJVMJD32CT4G | I_{CEO} | – – | 50 50 | μAdc |
| Collector Cutoff Current ($V_{CE} = \text{Rated } V_{CEO}$, $V_{EB} = 0$) | ICES | – | 20 | μAdc |
| Emitter Cutoff Current ($V_{BE} = 5\text{ Vdc}$, $I_C = 0$) | I_{EBO} | – | 1 | mAdc |

ON CHARACTERISTICS (Note 1)

| | | | | |
|---|---------------|----------|---------|-----|
| DC Current Gain ($I_C = 1\text{ Adc}$, $V_{CE} = 4\text{ Vdc}$) ($I_C = 3\text{ Adc}$, $V_{CE} = 4\text{ Vdc}$) | h_{FE} | 25 10 | – 50 | |
| Collector–Emitter Saturation Voltage ($I_C = 3\text{ Adc}$, $I_B = 375\text{ mAdc}$) | $V_{CE(sat)}$ | – | 1.2 | Vdc |
| Base–Emitter On Voltage ($I_C = 3\text{ Adc}$, $V_{CE} = 4\text{ Vdc}$) | $V_{BE(on)}$ | – | 1.8 | Vdc |

DYNAMIC CHARACTERISTICS

| | | | | |
|---|----------|----|---|-----|
| Current Gain – Bandwidth Product (Note 2) ($I_C = 500\text{ mAdc}$, $V_{CE} = 10\text{ Vdc}$, $f_{test} = 1\text{ MHz}$) | f_T | 3 | – | MHz |
| Small–Signal Current Gain ($I_C = 0.5\text{ Adc}$, $V_{CE} = 10\text{ Vdc}$, $f = 1\text{ kHz}$) | h_{fe} | 20 | – | |

1. Pulse Test: Pulse Width $\leq 300\ \mu\text{s}$, Duty Cycle $\leq 2\%$.
2. $f_T = |h_{fe}| \cdot f_{test}$.

MJD31, NJVMJD31T4G, MJD31C, NJVMJD31CT4G (NPN), MJD32, NJVMJD32T4G, MJD32C, NJVMJD32CG, NJVMJD32CT4G (PNP)

TYPICAL CHARACTERISTICS

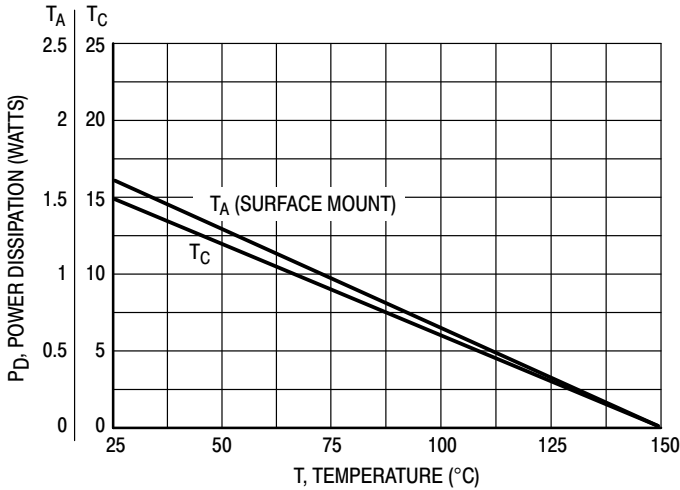
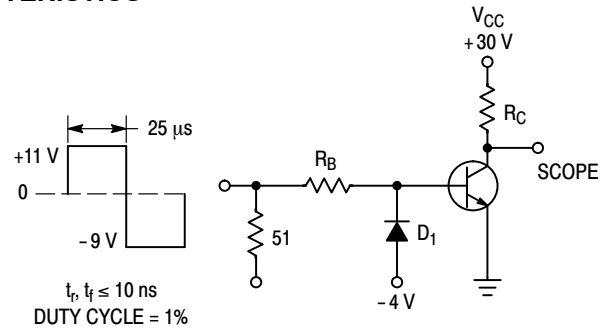

Figure 1. Power Derating



R_B and R_C VARIED TO OBTAIN DESIRED CURRENT LEVELS
 D_1 MUST BE FAST RECOVERY TYPE, e.g.:
 1N5825 USED ABOVE $I_B \approx 100$ mA
 MSD6100 USED BELOW $I_B \approx 100$ mA
 REVERSE ALL POLARITIES FOR PNP.

Figure 2. Switching Time Test Circuit

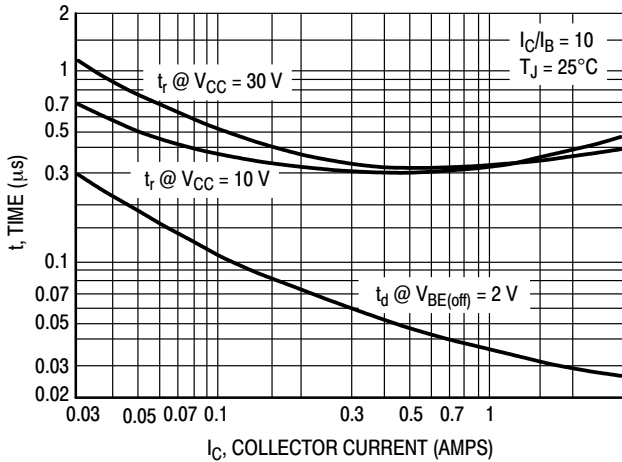

Figure 3. Turn-On Time

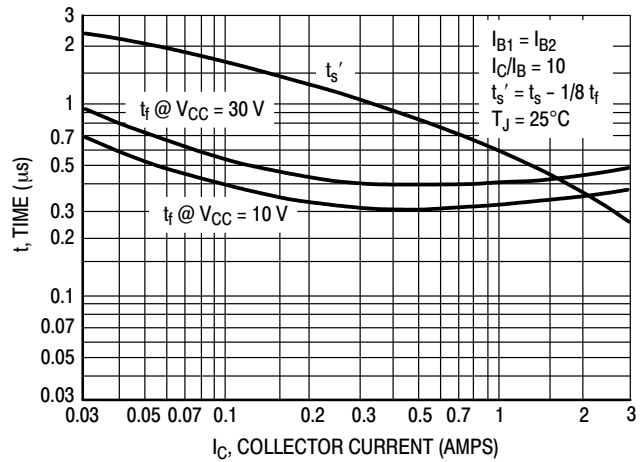

Figure 4. Turn-Off Time

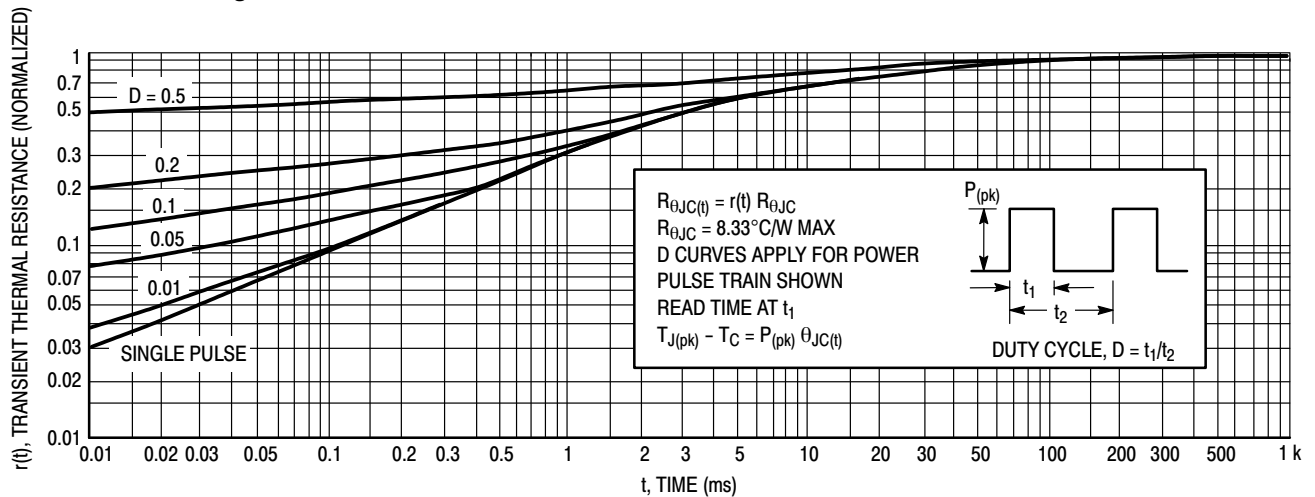

Figure 5. Thermal Response

MJD31, NJVMJD31T4G, MJD31C, NJVMJD31CT4G (NPN), MJD32, NJVMJD32T4G, MJD32C, NJVMJD32CG, NJVMJD32CT4G (PNP)

TYPICAL CHARACTERISTICS – MJD31, MJD31C (NPN)

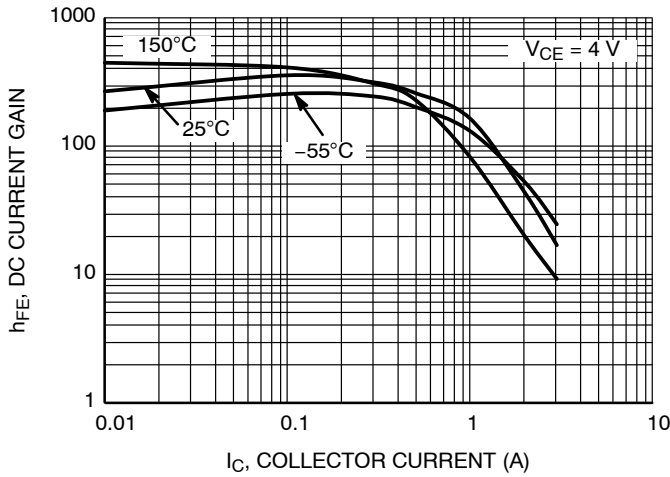

Figure 6. DC Current Gain at $V_{CE} = 4\text{ V}$

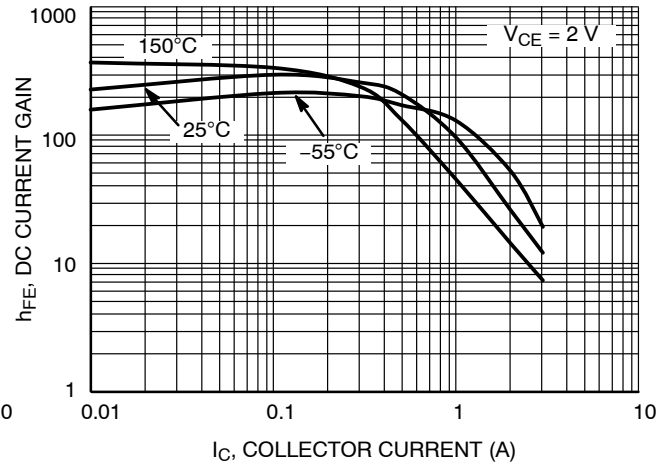

Figure 7. DC Current Gain at $V_{CE} = 2\text{ V}$

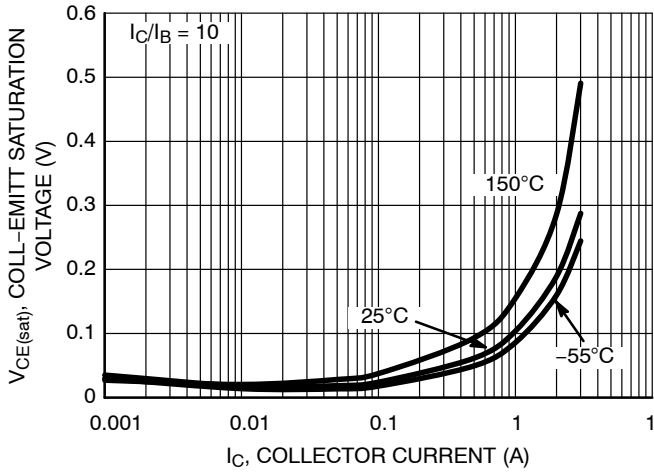

Figure 8. Collector-Emitter Saturation Voltage

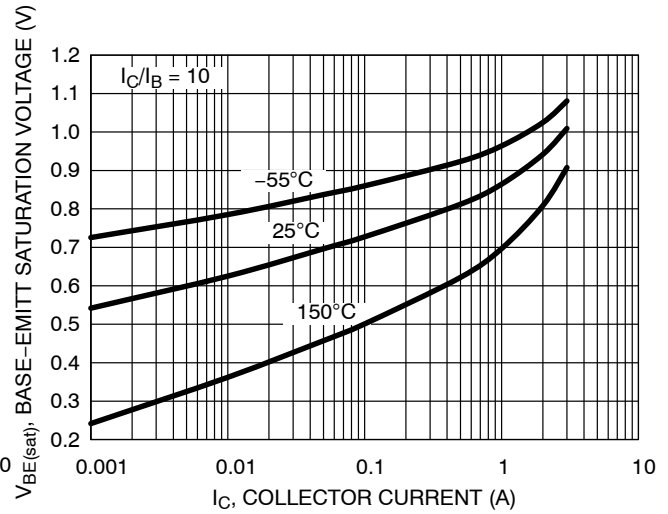

Figure 9. Base-Emitter Saturation Voltage

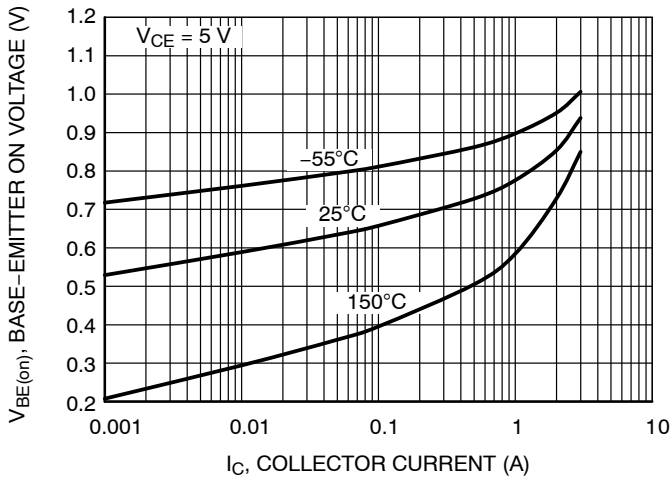

Figure 10. Base-Emitter "On" Voltage

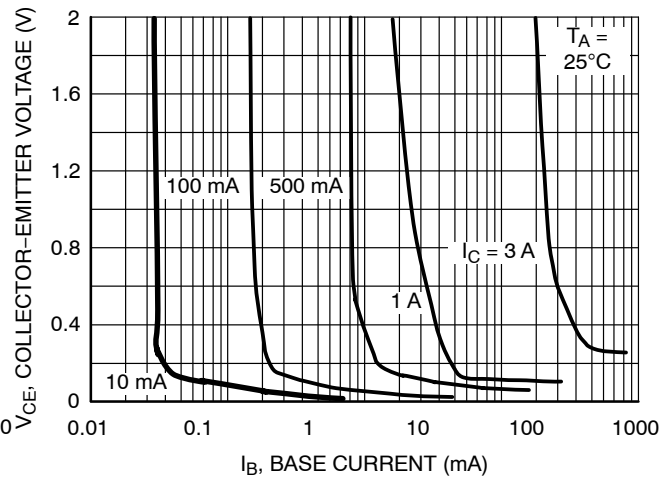

Figure 11. Collector Saturation Region

MJD31, NJVMJD31T4G, MJD31C, NJVMJD31CT4G (NPN), MJD32, NJVMJD32T4G, MJD32C, NJVMJD32CG, NJVMJD32CT4G (PNP)

TYPICAL CHARACTERISTICS – MJD31, MJD31C (NPN)

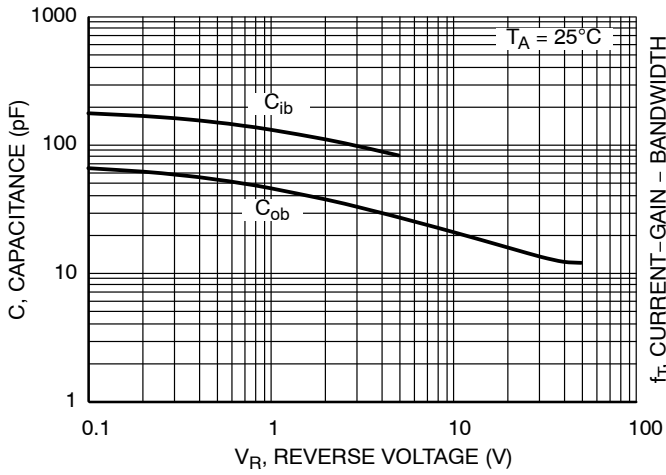

Figure 12. Capacitance

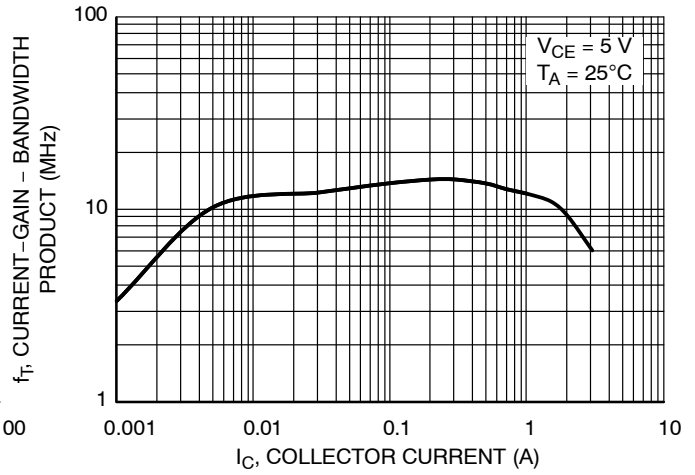

Figure 13. Current-Gain-Bandwidth Product

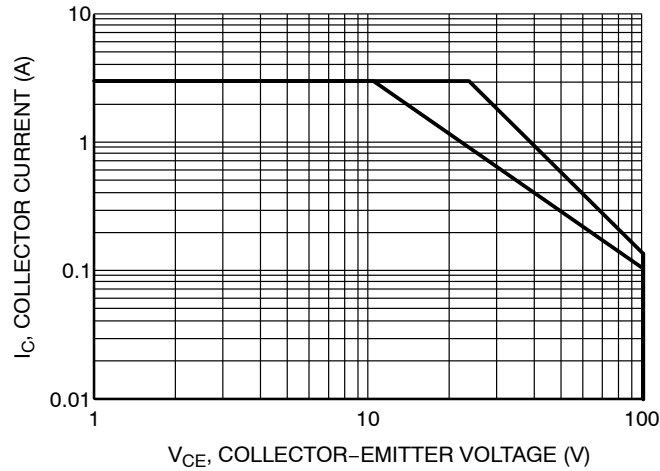

Figure 14. Safe Operating Area

MJD31, NJVMJD31T4G, MJD31C, NJVMJD31CT4G (NPN), MJD32, NJVMJD32T4G, MJD32C, NJVMJD32CG, NJVMJD32CT4G (PNP)

TYPICAL CHARACTERISTICS – MJD32, MJD32C (PNP)

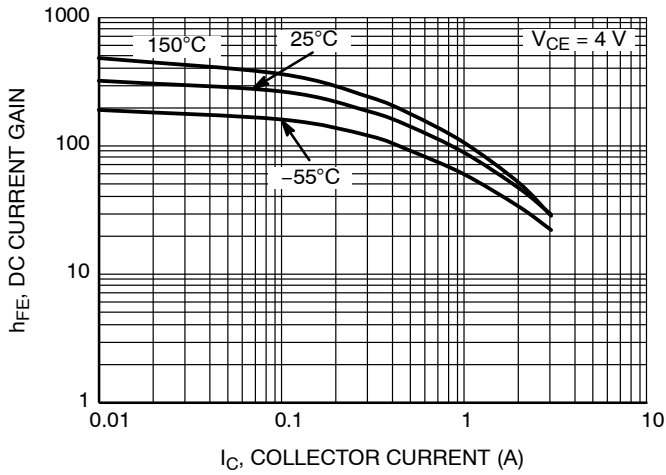

Figure 15. DC Current Gain at $V_{CE} = 4\text{ V}$

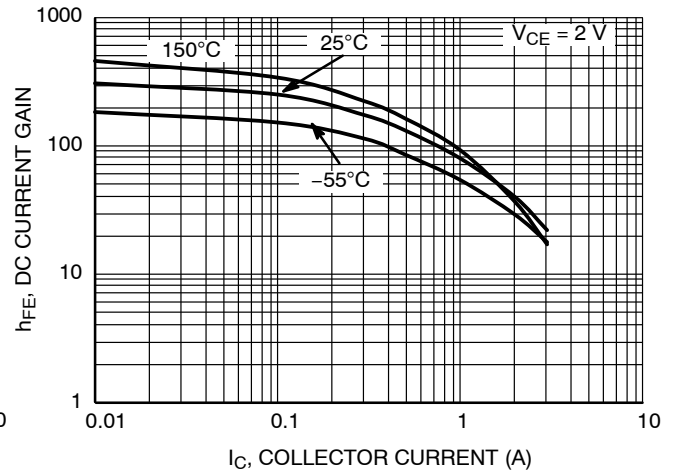

Figure 16. DC Current Gain at $V_{CE} = 2\text{ V}$

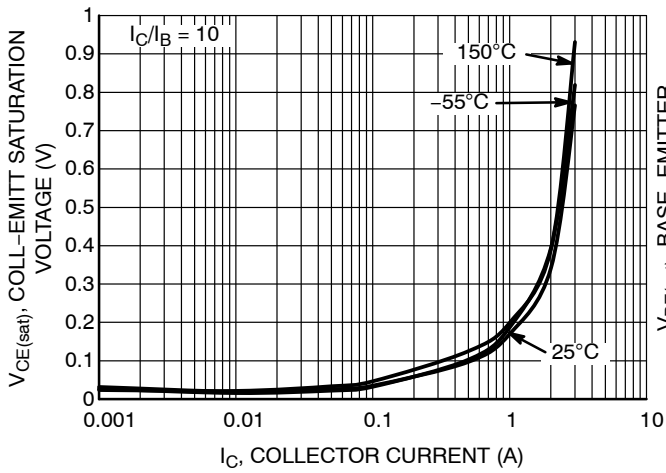

Figure 17. Collector-Emitter Saturation Voltage

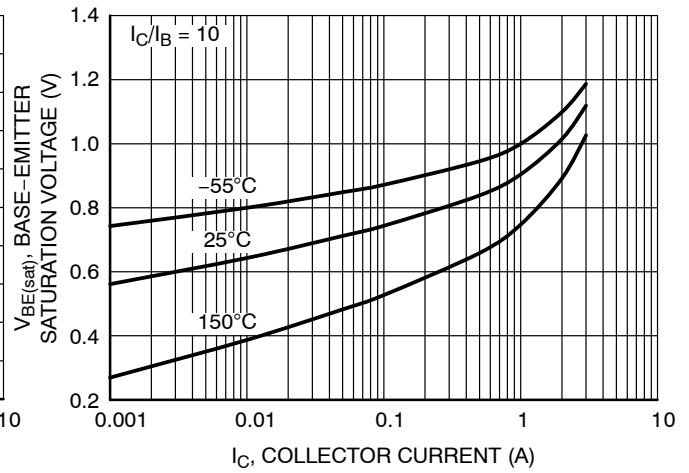

Figure 18. Base-Emitter Saturation Voltage

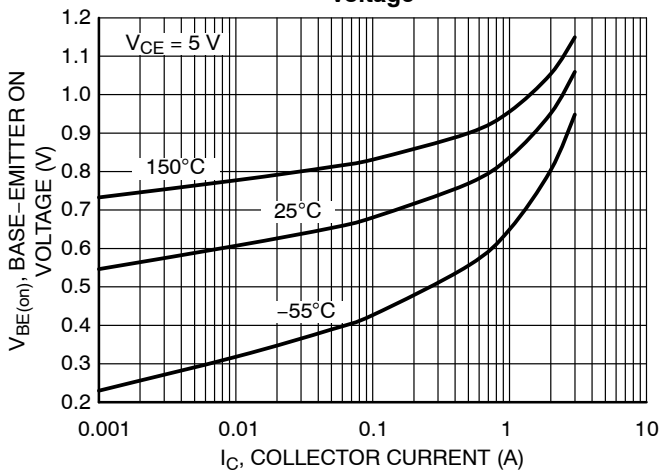

Figure 19. Base-Emitter "On" Voltage

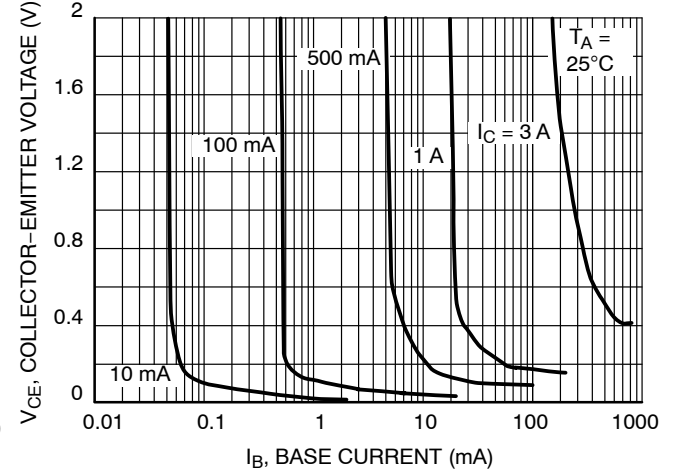

Figure 20. Collector Saturation Region

MJD31, NJVMJD31T4G, MJD31C, NJVMJD31CT4G (NPN), MJD32, NJVMJD32T4G, MJD32C, NJVMJD32CG, NJVMJD32CT4G (PNP)

TYPICAL CHARACTERISTICS

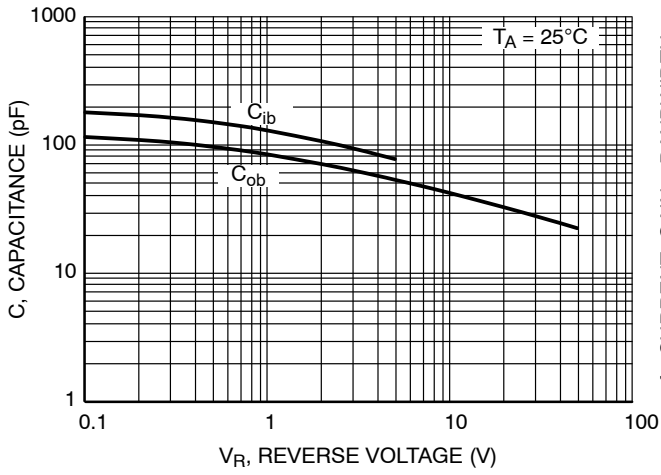

Figure 21. Capacitance

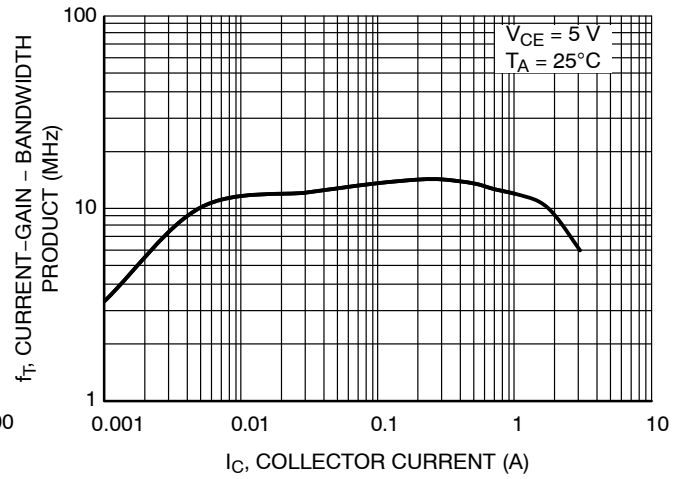

Figure 22. Current-Gain-Bandwidth Product

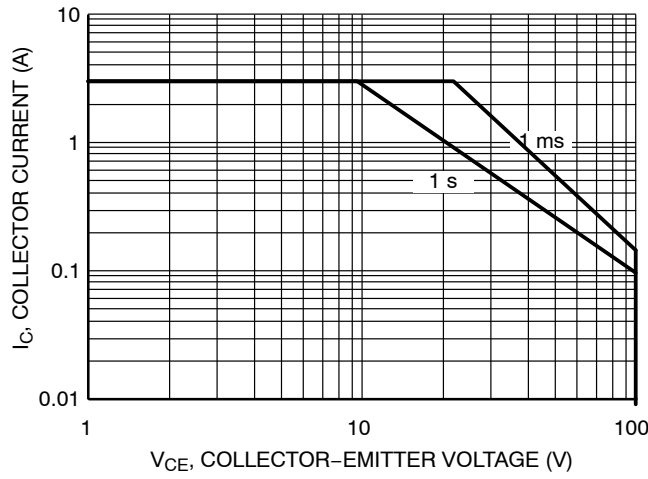

Figure 23. Safe Operating Area

**MJD31, NJVMJD31T4G, MJD31C, NJVMJD31CT4G (NPN), MJD32, NJVMJD32T4G,
MJD32C, NJVMJD32CG, NJVMJD32CT4G (PNP)**

ORDERING INFORMATION

| Device | Package Type | Package | Shipping [†] |
|--------------|---------------------|---------|-----------------------|
| MJD31CG | DPAK (Pb-Free) | 369C | 75 Units / Rail |
| MJD31C1G | DPAK-3 (Pb-Free) | 369D | 75 Units / Rail |
| MJD31CRLG | DPAK (Pb-Free) | 369C | 1,800 Tape & Reel |
| MJD31CT4G | DPAK (Pb-Free) | 369C | 2,500 Tape & Reel |
| NJVMJD31CT4G | DPAK (Pb-Free) | 369C | 2,500 Tape & Reel |
| MJD31T4G | DPAK (Pb-Free) | 369C | 2,500 Tape & Reel |
| NJVMJD31T4G | DPAK (Pb-Free) | 369C | 2,500 Tape & Reel |
| MJD32CG | DPAK (Pb-Free) | 369C | 75 Units / Rail |
| NJVMJD32CG | DPAK (Pb-Free) | 369C | 75 Units / Rail |
| MJD32CRLG | DPAK (Pb-Free) | 369C | 1,800 Tape & Reel |
| MJD32CT4 | DPAK | 369C | 2,500 Tape & Reel |
| MJD32CT4G | DPAK (Pb-Free) | 369C | 2,500 Tape & Reel |
| NJVMJD32CT4G | DPAK (Pb-Free) | 369C | 2,500 Tape & Reel |
| MJD32RLG | DPAK (Pb-Free) | 369C | 1,800 Tape & Reel |
| MJD32T4G | DPAK (Pb-Free) | 369C | 2,500 Tape & Reel |
| NJVMJD32T4G | DPAK (Pb-Free) | 369C | 2,500 Tape & Reel |

†For information on tape and reel specifications, including part orientation and tape sizes, please refer to our Tape and Reel Packaging Specifications Brochure, BRD8011/D.

MJD31, NJVMJD31T4G, MJD31C, NJVMJD31CT4G (NPN), MJD32, NJVMJD32T4G, MJD32C, NJVMJD32CG, NJVMJD32CT4G (PNP)

PACKAGE DIMENSIONS

DPAK
CASE 369C-01
ISSUE D

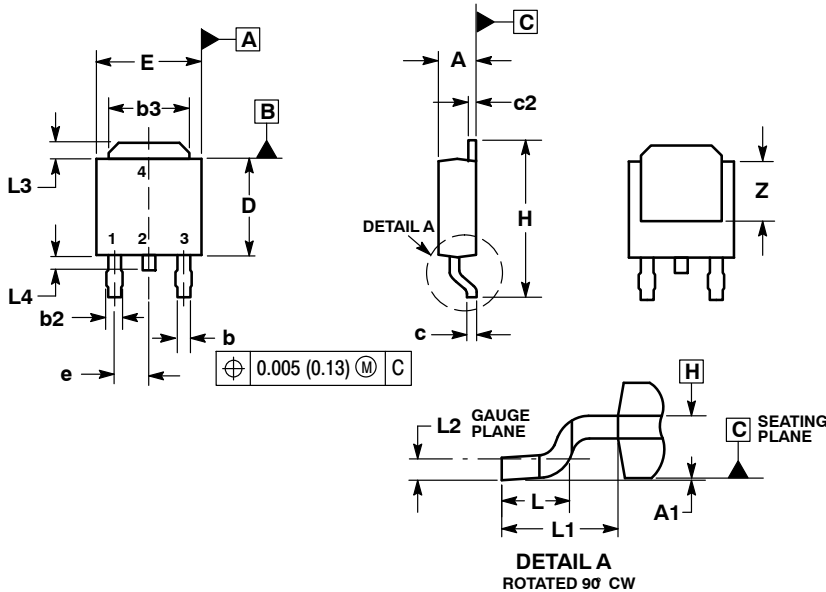

- NOTES:
1. DIMENSIONING AND TOLERANCING PER ASME Y14.5M, 1994.
 2. CONTROLLING DIMENSION: INCHES.
 3. THERMAL PAD CONTOUR OPTIONAL WITHIN DIMENSIONS b3, L3 and Z.
 4. DIMENSIONS D AND E DO NOT INCLUDE MOLD FLASH, PROTRUSIONS, OR BURRS. MOLD FLASH, PROTRUSIONS, OR GATE BURRS SHALL NOT EXCEED 0.006 INCHES PER SIDE.
 5. DIMENSIONS D AND E ARE DETERMINED AT THE OUTERMOST EXTREMES OF THE PLASTIC BODY.
 6. DATUMS A AND B ARE DETERMINED AT DATUM PLANE H.

| DIM | INCHES | | MILLIMETERS | |
|-----|-----------|-------|-------------|-------|
| | MIN | MAX | MIN | MAX |
| A | 0.086 | 0.094 | 2.18 | 2.38 |
| A1 | 0.000 | 0.005 | 0.00 | 0.13 |
| b | 0.025 | 0.035 | 0.63 | 0.89 |
| b2 | 0.030 | 0.045 | 0.76 | 1.14 |
| b3 | 0.180 | 0.215 | 4.57 | 5.46 |
| c | 0.018 | 0.024 | 0.46 | 0.61 |
| c2 | 0.018 | 0.024 | 0.46 | 0.61 |
| D | 0.235 | 0.245 | 5.97 | 6.22 |
| E | 0.250 | 0.265 | 6.35 | 6.73 |
| e | 0.090 BSC | | 2.29 BSC | |
| H | 0.370 | 0.410 | 9.40 | 10.41 |
| L | 0.055 | 0.070 | 1.40 | 1.78 |
| L1 | 0.108 REF | | 2.74 REF | |
| L2 | 0.020 BSC | | 0.51 BSC | |
| L3 | 0.035 | 0.050 | 0.89 | 1.27 |
| L4 | --- | 0.040 | --- | 1.01 |
| Z | 0.155 | --- | 3.93 | --- |

SOLDERING FOOTPRINT*

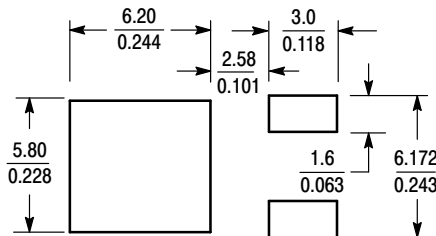

SCALE 3:1 (mm/inches)

- STYLE 1:
PIN 1. BASE
2. COLLECTOR
3. EMITTER
4. COLLECTOR

*For additional information on our Pb-Free strategy and soldering details, please download the ON Semiconductor Soldering and Mounting Techniques Reference Manual, SOLDERRM/D.

MJD31, NJVMJD31T4G, MJD31C, NJVMJD31CT4G (NPN), MJD32, NJVMJD32T4G, MJD32C, NJVMJD32CG, NJVMJD32CT4G (PNP)

PACKAGE DIMENSIONS

IPAK
CASE 369D-01
ISSUE C

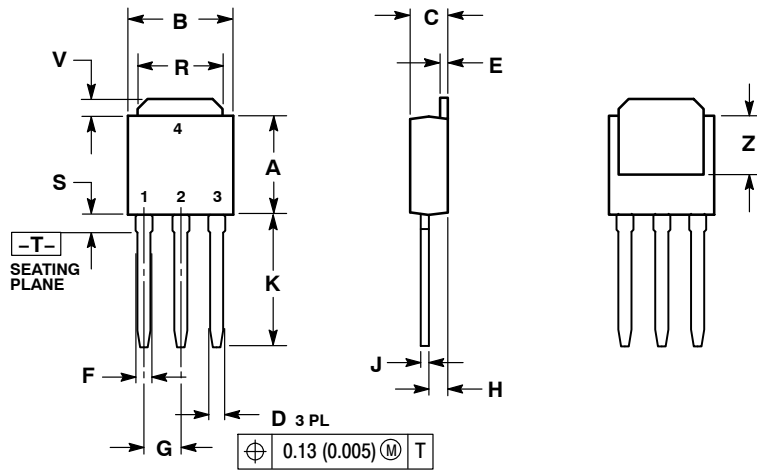

- NOTES:
1. DIMENSIONING AND TOLERANCING PER ANSI Y14.5M, 1982.
2. CONTROLLING DIMENSION: INCH.

| DIM | INCHES | | MILLIMETERS | |
|-----|-----------|-------|-------------|------|
| | MIN | MAX | MIN | MAX |
| A | 0.235 | 0.245 | 5.97 | 6.35 |
| B | 0.250 | 0.265 | 6.35 | 6.73 |
| C | 0.086 | 0.094 | 2.19 | 2.38 |
| D | 0.027 | 0.035 | 0.69 | 0.88 |
| E | 0.018 | 0.023 | 0.46 | 0.58 |
| F | 0.037 | 0.045 | 0.94 | 1.14 |
| G | 0.090 BSC | | 2.29 BSC | |
| H | 0.034 | 0.040 | 0.87 | 1.01 |
| J | 0.018 | 0.023 | 0.46 | 0.58 |
| K | 0.350 | 0.380 | 8.89 | 9.65 |
| R | 0.180 | 0.215 | 4.45 | 5.45 |
| S | 0.025 | 0.040 | 0.63 | 1.01 |
| V | 0.035 | 0.050 | 0.89 | 1.27 |
| Z | 0.155 | --- | 3.93 | --- |

- STYLE 1:
PIN 1: BASE
2. COLLECTOR
3. EMITTER
4. COLLECTOR

ON Semiconductor and are registered trademarks of Semiconductor Components Industries, LLC (SCILLC). SCILLC reserves the right to make changes without further notice to any products herein. SCILLC makes no warranty, representation or guarantee regarding the suitability of its products for any particular purpose, nor does SCILLC assume any liability arising out of the application or use of any product or circuit, and specifically disclaims any and all liability, including without limitation special, consequential or incidental damages. "Typical" parameters which may be provided in SCILLC data sheets and/or specifications can and do vary in different applications and actual performance may vary over time. All operating parameters, including "Typicals" must be validated for each customer application by customer's technical experts. SCILLC does not convey any license under its patent rights nor the rights of others. SCILLC products are not designed, intended, or authorized for use as components in systems intended for surgical implant into the body, or other applications intended to support or sustain life, or for any other application in which the failure of the SCILLC product could create a situation where personal injury or death may occur. Should Buyer purchase or use SCILLC products for any such unintended or unauthorized application, Buyer shall indemnify and hold SCILLC and its officers, employees, subsidiaries, affiliates, and distributors harmless against all claims, costs, damages, and expenses, and reasonable attorney fees arising out of, directly or indirectly, any claim of personal injury or death associated with such unintended or unauthorized use, even if such claim alleges that SCILLC was negligent regarding the design or manufacture of the part. SCILLC is an Equal Opportunity/Affirmative Action Employer. This literature is subject to all applicable copyright laws and is not for resale in any manner.

PUBLICATION ORDERING INFORMATION

LITERATURE FULFILLMENT:
Literature Distribution Center for ON Semiconductor
P.O. Box 5163, Denver, Colorado 80217 USA
Phone: 303-675-2175 or 800-344-3860 Toll Free USA/Canada
Fax: 303-675-2176 or 800-344-3867 Toll Free USA/Canada
Email: orderlit@onsemi.com

N. American Technical Support: 800-282-9855 Toll Free USA/Canada
Europe, Middle East and Africa Technical Support:
Phone: 421 33 790 2910
Japan Customer Focus Center
Phone: 81-3-5817-1050

ON Semiconductor Website: www.onsemi.com
Order Literature: <http://www.onsemi.com/orderlit>
For additional information, please contact your local Sales Representative



Стандарт Электрон Связь

Мы молодая и активно развивающаяся компания в области поставок электронных компонентов. Мы поставляем электронные компоненты отечественного и импортного производства напрямую от производителей и с крупнейших складов мира.

Благодаря сотрудничеству с мировыми поставщиками мы осуществляем комплексные и плановые поставки широчайшего спектра электронных компонентов.

Собственная эффективная логистика и склад в обеспечивает надежную поставку продукции в точно указанные сроки по всей России.

Мы осуществляем техническую поддержку нашим клиентам и предпродажную проверку качества продукции. На все поставляемые продукты мы предоставляем гарантию .

Осуществляем поставки продукции под контролем ВП МО РФ на предприятия военно-промышленного комплекса России , а также работаем в рамках 275 ФЗ с открытием отдельных счетов в уполномоченном банке. Система менеджмента качества компании соответствует требованиям ГОСТ ISO 9001.

Минимальные сроки поставки, гибкие цены, неограниченный ассортимент и индивидуальный подход к клиентам являются основой для выстраивания долгосрочного и эффективного сотрудничества с предприятиями радиоэлектронной промышленности, предприятиями ВПК и научно-исследовательскими институтами России.

С нами вы становитесь еще успешнее!

Наши контакты:

Телефон: +7 812 627 14 35

Электронная почта: sales@st-electron.ru

Адрес: 198099, Санкт-Петербург,
Промышленная ул, дом № 19, литера Н,
помещение 100-Н Офис 331