

\* Selected Packages  
**U.L. RECOGNIZED**  
 File #E71639

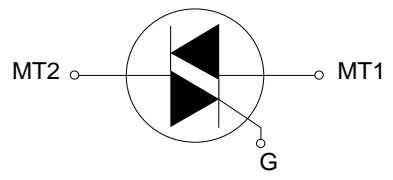
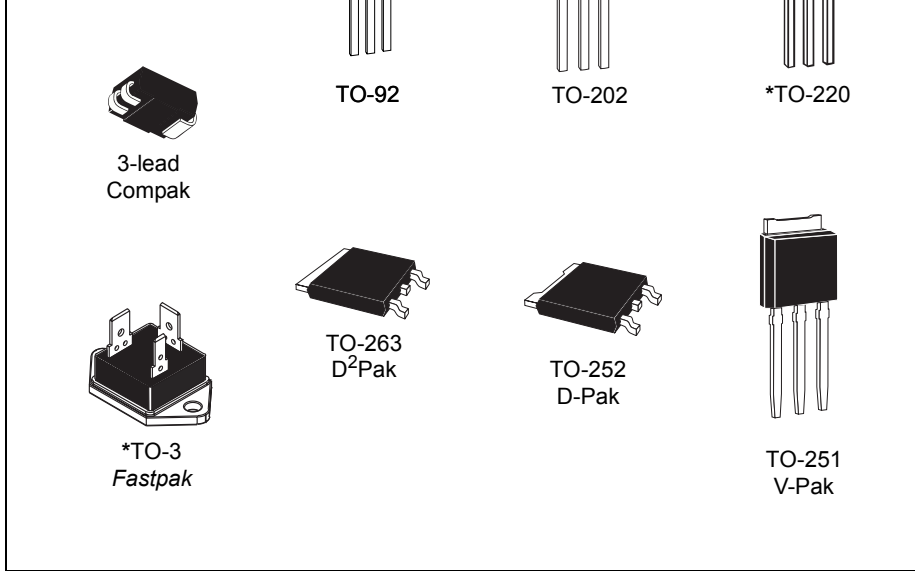

# Triacs

(0.8 A to 35 A) RoHS

## General Description

These gated triacs from Teccor Electronics are part of a broad line of bidirectional semiconductors. The devices range in current ratings from 0.8 A to 35 A and in voltages from 200 V to 1000 V.

The triac may be gate triggered from a blocking to conduction state for either polarity of applied voltage and is designed for AC switching and phase control applications such as speed and temperature modulation controls, lighting controls, and static switching relays. The triggering signal is normally applied between the gate and MT1.

Isolated packages are offered with internal construction, having the case or mounting tab electrically isolated from the semiconductor chip. This feature facilitates the use of low-cost assembly and convenient packaging techniques. Tape-and-reel capability is available. See "Packing Options" section of this catalog.

All Teccor triacs have glass-passivated junctions to ensure long-term device reliability and parameter stability. Teccor's glass-passivated junctions offer a rugged, reliable barrier against junction contamination.







Variations of devices covered in this data sheet are available for custom design applications. Consult factory for more information.

## Features

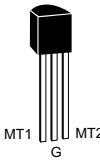
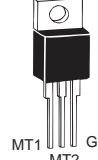
- **RoHS Compliant**
- **Electrically-isolated packages**
- **Glass-passivated junctions**
- **Voltage capability — up to 1000 V**
- **Surge capability — up to 200 A**

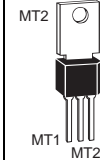
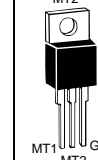
## Compak Package

- **Surface mount package — 0.8 A and 1 A series**
- **New small profile three-leaded Compak package**
- **Packaged in embossed carrier tape with 2,500 devices per reel**
- **Can replace SOT-223**

I <sub>T(RMS)</sub> (4)	Part Number								V <sub>DRM</sub> (1)	I <sub>GT</sub> (3) (7) (15)					
	Isolated			Non-isolated						Volts	mAmps				
										QI	QII	QIII	QIV	QIV	
MAX	See "Package Dimensions" section for variations. (11)								MIN	MAX					TYP
0.8 A	Q2X8E3		Q2X3						200	10	10	10		25	
	Q4X8E3		Q4X3						400	10	10	10		25	
	Q6X8E3		Q6X3						600	10	10	10		25	
	Q2X8E4		Q2X4						200	25	25	25		50	
	Q4X8E4		Q4X4						400	25	25	25		50	
1 A	Q6X8E4		Q6X4						600	25	25	25		50	
	Q201E3		Q2N3						200	10	10	10		25	
	Q401E3		Q4N3						400	10	10	10		25	
	Q601E3		Q6N3						600	10	10	10		25	
	Q201E4		Q2N4						200	25	25	25		50	
4 A	Q401E4		Q4N4						400	25	25	25		50	
	Q601E4		Q6N4						600	25	25	25		50	
		Q2004L3		Q2004F31		Q2004D3	Q2004V3		200	10	10	10		25	
		Q4004L3		Q4004F31		Q4004D3	Q4004V3		400	10	10	10		25	
		Q6004L3		Q6004F31		Q6004D3	Q6004V3		600	10	10	10		25	
		Q2004L4		Q2004F41		Q2004D4	Q2004V4		200	25	25	25		50	
		Q4004L4		Q4004F41		Q4004D4	Q4004V4		400	25	25	25		50	
		Q6004L4		Q6004F41		Q6004D4	Q6004V4		600	25	25	25		50	
6 A		Q8004L4				Q8004D4	Q8004V4		800	25	25	25		50	
		QK004L4				QK004D4	QK004V4		1000	25	25	25		50	
		Q2006L4		Q2006F41	Q2006R4		Q2006N4		200	25	25	25		50	
		Q4006L4		Q4006F41	Q4006R4		Q4006N4		400	25	25	25		50	
		Q6006L5		Q6006F51	Q6006R5		Q6006N5		600	50	50	50		75	
8 A		Q8006L5			Q8006R5		Q8006N5		800	50	50	50		75	
		QK006L5			QK006R5		QK006N5		1000	50	50	50		75	
		Q2008L4		Q2008F41	Q2008R4		Q2008N4		200	25	25	25		50	
		Q4008L4		Q4008F41	Q4008R4		Q4008N4		400	25	25	25		50	
		Q6008L5		Q6008F51	Q6008R5		Q6008N5		600	50	50	50		75	
	Q8008L5			Q8008R5		Q8008N5		800	50	50	50		75		
	QK008L5			QK008R5		QK008N5		1000	50	50	50		75		

See "General Notes" on page E2 - 4 and "Electrical Specification Notes" on page E2 - 5.

$I_{DRM}$			$V_{TM}$	$V_{GT}$	$I_H$	$I_{GTM}$	$P_{GM}$	$P_{G(AV)}$	$I_{TSM}$	$dv/dt(c)$	$dv/dt$		$t_{gt}$	$I^2t$	$di/dt$
(1) (16)			(1) (5)	(2) (6) (15) (18) (19)	(1) (8) (12)	(14)	(14)		(9) (13)	(1) (4) (13)	(1)		(10)		
mAmps			Volts	Volts					Amps		Volts/ $\mu$ Sec				
$T_C = 25^\circ C$	$T_C = 100^\circ C$	$T_C = 125^\circ C$	$T_C = 25^\circ C$	$T_C = 25^\circ C$	mAmps	Amps	Watts	Watts	60/50 Hz	Volts/ $\mu$ Sec	$T_C = 100^\circ C$	$T_C = 125^\circ C$	$\mu$ Sec	Amp <sup>2</sup> Sec	Amps/ $\mu$ Sec
MAX			MAX	MAX	MAX					TYP	MIN		TYP		
0.02	0.5	1	1.6	2	15	1	10	0.2	10/8.3	1	40	30	2.5	0.41	20
0.02	0.5	1	1.6	2	15	1	10	0.2	10/8.3	1	35	25	2.5	0.41	20
0.02	0.5	1	1.6	2	15	1	10	0.2	10/8.3	1	25	15	2.5	0.41	20
0.02	0.5	1	1.6	2.5	25	1	10	0.2	10/8.3	1	50	40	3	0.41	20
0.02	0.5	1	1.6	2.5	25	1	10	0.2	10/8.3	1	45	35	3	0.41	20
0.02	0.5	1	1.6	2.5	25	1	10	0.2	10/8.3	1	35	25	3	0.41	20
0.02	0.5	1	1.6	2	15	1	10	0.2	20/16.7	1	40	30	2.5	1.6	30
0.02	0.5	1	1.6	2	15	1	10	0.2	20/16.7	1	40	30	2.5	1.6	30
0.02	0.5	1	1.6	2	15	1	10	0.2	20/16.7	1	30	20	2.5	1.6	30
0.02	0.5	1	1.6	2.5	25	1	10	0.2	20/16.7	1	50	40	3	1.6	30
0.02	0.5	1	1.6	2.5	25	1	10	0.2	20/16.7	1	50	40	3	1.6	30
0.02	0.5	1	1.6	2.5	25	1	10	0.2	20/16.7	1	40	30	3	1.6	30
0.05	0.5	2	1.6	2	20	1.2	15	0.3	55/46	2	50	40	2.5	12.5	50
0.05	0.5	2	1.6	2	20	1.2	15	0.3	55/46	2	50	40	2.5	12.5	50
0.05	0.5	2	1.6	2	20	1.2	15	0.3	55/46	2	40	30	2.5	12.5	50
0.05	0.5	2	1.6	2.5	30	1.2	15	0.3	55/46	2	100	75	3	12.5	50
0.05	0.5	2	1.6	2.5	30	1.2	15	0.3	55/46	2	100	75	3	12.5	50
0.05	0.5	2	1.6	2.5	30	1.2	15	0.3	55/46	2	75	50	3	12.5	50
0.05	0.5	2	1.6	2.5	30	1.2	15	0.3	55/46	2	60	40	3	12.5	50
0.05	3		1.6	2.5	30	1.2	15	0.3	55/46	2	50		3	12.5	50
0.05	0.5	2	1.6	2.5	50	1.6	18	0.5	80/65	4	200	120	3	26.5	70
0.05	0.5	2	1.6	2.5	50	1.6	18	0.5	80/65	4	200	120	3	26.5	70
0.05	0.5	2	1.6	2.5	50	1.6	18	0.5	80/65	4	150	100	3	26.5	70
0.05	0.5	2	1.6	2.5	50	1.6	18	0.5	80/65	4	125	85	3	26.5	70
0.05	3		1.6	2.5	50	1.6	18	0.5	80/65	4	100		3	26.5	70
0.05	0.5	2	1.6	2.5	50	1.8	20	0.5	100/83	4	250	150	3	41	70
0.05	0.5	2	1.6	2.5	50	1.8	20	0.5	100/83	4	250	150	3	41	70
0.05	0.5	2	1.6	2.5	50	1.8	20	0.5	100/83	4	220	125	3	41	70
0.05	0.5	2	1.6	2.5	50	1.8	20	0.5	100/83	4	150	100	3	41	70
0.05	3		1.6	2.5	50	1.8	20	0.5	100/83	4	100		3	41	70

See "General Notes" on page E2 - 4 and "Electrical Specification Notes" on page E2 - 5.

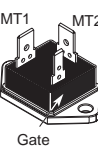
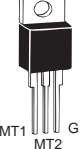
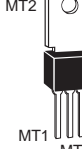
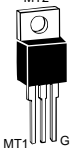
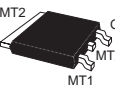
I <sub>T(RMS)</sub> (4) (16)	Part Number					V <sub>DRM</sub> (1)	I <sub>GT</sub>					I <sub>DRM</sub>			
	Isolated		Non-isolated				mAmps					mAmps			
						Volts	QI	QII	QIII	QIV	QIV	T <sub>C</sub> = 25 °C	T <sub>C</sub> = 100 °C	T <sub>C</sub> = 125 °C	
MAX	See "Package Dimensions" section for variations. (11)					MIN	MAX					TYP	MAX		
10 A		<b>Q2010L4</b>		<b>Q2010R4</b>	<b>Q2010N4</b>	200	25	25	25	50		0.05	1		
		<b>Q4010L4</b>		<b>Q4010R4</b>	<b>Q4010N4</b>	400	25	25	25	50		0.05	1		
		<b>Q6010L4</b>		<b>Q6010R4</b>	<b>Q6010N4</b>	600	25	25	25	50		0.05	1		
		<b>Q8010L4</b>		<b>Q8010R4</b>	<b>Q8010N4</b>	800	25	25	25	50		0.1	1		
		<b>QK010L4</b>		<b>QK010R4</b>	<b>QK010N4</b>	1000	25	25	25	50		0.1	3		
		<b>Q2010L5</b>	<b>Q2010F51</b>	<b>Q2010R5</b>	<b>Q2010N5</b>	200	50	50	50		75	0.05	0.5	2	
		<b>Q4010L5</b>	<b>Q4010F51</b>	<b>Q4010R5</b>	<b>Q4010N5</b>	400	50	50	50		75	0.05	0.5	2	
		<b>Q6010L5</b>	<b>Q6010F51</b>	<b>Q6010R5</b>	<b>Q6010N5</b>	600	50	50	50		75	0.05	0.5	2	
15 A				<b>Q8010R5</b>	<b>Q8010N5</b>	800	50	50	50		75	0.1	0.5	2	
		<b>QK010L5</b>		<b>QK010R5</b>	<b>QK010N5</b>	1000	50	50	50		75	0.1	3		
		<b>Q2015L5</b>		<b>Q2015R5</b>	<b>Q2015N5</b>	200	50	50	50			0.05	0.5	2	
		<b>Q4015L5</b>		<b>Q4015R5</b>	<b>Q4015N5</b>	400	50	50	50			0.05	0.5	2	
		<b>Q6015L5</b>		<b>Q6015R5</b>	<b>Q6015N5</b>	600	50	50	50			0.05	0.5	2	
25 A				<b>Q8015R5</b>	<b>Q8015N5</b>	800	50	50	50			0.1	1	3	
				<b>QK015L5</b>	<b>QK015N5</b>	1000	50	50	50			0.1	3		
				<b>Q2025R5</b>	<b>Q2025N5</b>	200	50	50	50			0.1	1	3	
				<b>Q4025R5</b>	<b>Q4025N5</b>	400	50	50	50			0.1	1	3	
				<b>Q6025R5</b>	<b>Q6025N5</b>	600	50	50	50			0.1	1	3	
				<b>Q8025R5</b>	<b>Q8025N5</b>	800	50	50	50			0.1	1	3	
35 A		<b>QK025R5</b>		<b>QK025N5</b>		1000	50	50	50			0.1	3		
		<b>Q6025P5</b>				600	50	50	50		120	0.1		5	
		<b>Q8025P5</b>				800	50	50	50		120	0.1		5	
		<b>Q6035P5</b>				600	50	50	50		120	0.1		5	
	<b>Q8035P5</b>				800	50	50	50		120	0.1		5		

**Specific Test Conditions**

- di/dt** — Maximum rate-of-change of on-state current; I<sub>GT</sub> = 200 mA with ≤0.1 μs rise time
- dv/dt** — Critical rate-of-rise of off-state voltage at rated V<sub>DRM</sub> gate open
- dv/dt(c)** — Critical rate-of-rise of commutation voltage at rated V<sub>DRM</sub> and I<sub>T(RMS)</sub> commutating di/dt = 0.54 rated I<sub>T(RMS)</sub>/ms; gate unenergized
- I<sup>2</sup>t** — RMS surge (non-repetitive) on-state current for period of 8.3 ms for fusing
- I<sub>DRM</sub>** — Peak off-state current, gate open; V<sub>DRM</sub> = maximum rated value
- I<sub>GT</sub>** — DC gate trigger current in specific operating quadrants; V<sub>D</sub> = 12 V dc
- I<sub>GTM</sub>** — Peak gate trigger current
- I<sub>H</sub>** — Holding current (DC); gate open
- I<sub>T(RMS)</sub>** — RMS on-state current conduction angle of 360°
- I<sub>TSM</sub>** — Peak one-cycle surge
- P<sub>G(AV)</sub>** — Average gate power dissipation
- P<sub>GM</sub>** — Peak gate power dissipation; I<sub>GT</sub> ≤ I<sub>GTM</sub>
- t<sub>gt</sub>** — Gate controlled turn-on time; I<sub>GT</sub> = 200 mA with 0.1 μs rise time

- V<sub>DRM</sub>** — Repetitive peak blocking voltage
- V<sub>GT</sub>** — DC gate trigger voltage; V<sub>D</sub> = 12 V dc; R<sub>L</sub> = 60 Ω
- V<sub>TM</sub>** — Peak on-state voltage at maximum rated RMS current

**General Notes**

- All measurements are made at 60 Hz with a resistive load at an ambient temperature of +25 °C unless specified otherwise.
- Operating temperature range (T<sub>J</sub>) is -65 °C to +125 °C for TO-92, -25 °C to +125 °C for Fastpak, and -40 °C to +125 °C for all other devices.
- Storage temperature range (T<sub>S</sub>) is -65 °C to +150 °C for TO-92, -40 °C to +150 °C for TO-202, and -40 °C to +125 °C for all other devices.
- Lead solder temperature is a maximum of 230 °C for 10 seconds, maximum; ≥1/16" (1.59 mm) from case.
- The case temperature (T<sub>C</sub>) is measured as shown on the dimensional outline drawings. See "Package Dimensions" section of this catalog.

$V_{TM}$	$V_{GT}$	$I_H$	$I_{GTM}$	$P_{GM}$	$P_{G(AV)}$	$I_{TSM}$	$dv/dt(c)$	$dv/dt$		$t_{gt}$	$I^2t$	$di/dt$
(1) (5)	(2) (6) (15) (18) (19)	(1) (8) (12)	(14)	(14)		(9) (13)	(1) (4) (13)	(1)		(10) (17)		
Volts	Volts					Amps		Volts/ $\mu$ Sec				
$T_C = 25^\circ C$	$T_C = 25^\circ C$	mAmps	Amps	Watts	Watts	60/50 Hz	Volts/ $\mu$ Sec	$T_C = 100^\circ C$	$T_C = 125^\circ C$	$\mu$ Sec	Amps <sup>2</sup> Sec	Amps/ $\mu$ Sec
MAX	MAX	MAX					TYP	MIN		TYP		
1.6	2.5	35	1.8	20	0.5	120/100	2	150		3	60	70
1.6	2.5	35	1.8	20	0.5	120/100	2	150		3	60	70
1.6	2.5	35	1.8	20	0.5	120/100	2	100		3	60	70
1.6	2.5	35	1.8	20	0.5	120/100	2	75		3	60	70
1.6	2.5	35	1.8	20	0.5	120/100	2	50		3	60	70
1.6	2.5	50	1.8	20	0.5	120/100	4	350	225	3	60	70
1.6	2.5	50	1.8	20	0.5	120/100	4	350	225	3	60	70
1.6	2.5	50	1.8	20	0.5	120/100	4	300	200	3	60	70
1.6	2.5	50	1.8	20	0.5	120/100	4	250	175	3	60	70
1.6	2.5	50	1.8	20	0.5	120/100	4	150		3	60	70
1.6	2.5	70	2	20	0.5	200/167	4	400	275	4	166	100
1.6	2.5	70	2	20	0.5	200/167	4	400	275	4	166	100
1.6	2.5	70	2	20	0.5	200/167	4	350	225	4	166	100
1.6	2.5	70	2	20	0.5	200/167	4	300	200	4	166	100
1.6	2.5	70	2	20	0.5	200/167	4	200		4	166	100
1.8	2.5	100	2	20	0.5	200/167	5	400	275	4	166	100
1.8	2.5	100	2	20	0.5	200/167	5	400	275	4	166	100
1.8	2.5	100	2	20	0.5	200/167	5	350	225	4	166	100
1.8	2.5	100	2	20	0.5	200/167	5	300	200	4	166	100
1.8	2.5	100	2	20	0.5	200/167	5	200		4	166	100
1.4	2.75	50	2	20	0.5	250/220	5	550	475	3	260	100
1.4	2.75	50	2	20	0.5	250/220	5	450	400	3	260	100
1.5	2.75	50	2	20	0.5	350/300	5	550	475	3	508	100
1.5	2.75	50	2	20	0.5	350/300	5	450	400	3	508	100

## Electrical Specification Notes

- For either polarity of MT2 with reference to MT1 terminal
- For either polarity of gate voltage ( $V_{GT}$ ) with reference to MT1 terminal
- See Gate Characteristics and Definition of Quadrants.
- See Figure E2.1 through Figure E2.7 for current rating at specific operating temperature.
- See Figure E2.8 through Figure E2.10 for  $i_T$  versus  $v_T$ .
- See Figure E2.12 for  $V_{GT}$  versus  $T_C$ .
- See Figure E2.11 for  $I_{GT}$  versus  $T_C$ .
- See Figure E2.14 for  $I_H$  versus  $T_C$ .
- See Figure E2.13 for surge rating with specific durations.
- See Figure E2.15 for  $t_{gt}$  versus  $I_{GT}$ .
- See package outlines for lead form configurations. When ordering special lead forming, add type number as suffix to part number.
- Initial on-state current = 200 mA dc for 0.8 A to 10 A devices, 400 mA dc for 15 A to 35 A devices
- See Figure E2.1 through Figure E2.6 for maximum allowable case temperature at maximum rated current.
- Pulse width  $\leq 10 \mu s$ ;  $I_{GT} \leq I_{GTM}$

- $R_L = 60 \Omega$  for 0.8 A to 10 A triacs;  $R_L = 30 \Omega$  for 15 A to 35 A triacs
- $T_C = T_J$  for test conditions in off state
- $I_{GT} = 300$  mA for 25 A and 35 A devices
- Quadrants I, II, III only
- Minimum non-trigger  $V_{GT}$  at 125 °C is 0.2 V for all except 50 mA MAX QIV devices which are 0.2 V at 110 °C.

## Gate Characteristics

Teccor triacs may be turned on between gate and MT1 terminals in the following ways:

- In-phase signals (with standard AC line) using Quadrants I and III
- Application of unipolar pulses (gate always positive or negative), using Quadrants II and III with negative gate pulses and Quadrants I and IV with positive gate pulses

However, due to higher gate requirements for Quadrant IV, it is recommended that only negative pulses be applied. If positive pulses are required, see "Sensitive Triacs" section of this catalog or contact the factory. Also, see Figure AN1002.8, "Amplified Gate" Thyristor Circuit.

In all cases, if maximum surge capability is required, pulses should be a minimum of one magnitude above  $I_{GT}$  rating with a steep rising waveform ( $\leq 1 \mu s$  rise time).

### Electrical Isolation

Teccor's isolated triac packages will withstand a minimum high potential test of 2500 V ac rms from leads to mounting tab or base, over the operating temperature range of the device. The following isolation table shows standard and optional isolation ratings.

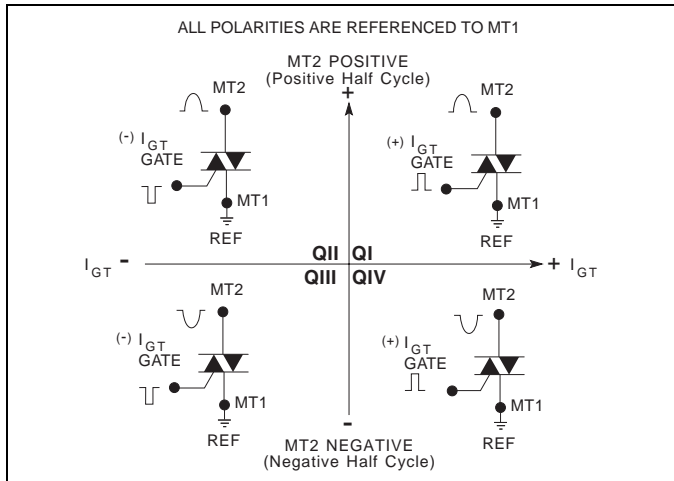







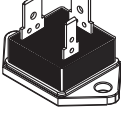

Definition of Quadrants

Electrical Isolation from Leads to Mounting Tab *		
V AC RMS	TO-220 Isolated	Fastpak Isolated
2500	Standard	Standard
4000	Optional **	N/A

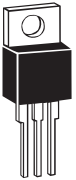
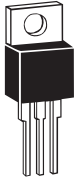
\* UL Recognized File E71639

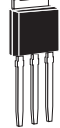
\*\* For 4000 V isolation, use V suffix in part number.

Thermal Resistance (Steady State) $R_{\theta JC}$ [ $R_{\theta JA}$ ] (TYP.) °C/W										
Package Code	P	E	C	F	F2	L	R	D	V	N
Type	 TO-3 Fastpak	 TO-92	 Compak	 TO-202 Type 1	 TO-202 Type 2	 TO-220 Isolated	 TO-220 Non-isolated	 TO-252 D-Pak	 TO-251 V-Pak	 TO-263 D <sup>2</sup> Pak
0.8 A		60 [135]	60 *							
1 A		50 [95]	40 *							
4 A				3.5 [45]	6 [70]	3.6 [50]		3.5	6.0 [70]	
6 A				3.8		3.3	1.8 [45]			1.8
8 A				3.3		2.8	1.5			1.5
10 A				3.5		2.6	1.3			1.3
15 A						2.1	1.1			1.1
25 A	1.6						0.89			0.89
35 A	1.5									

\* Mounted on 1 cm<sup>2</sup> copper foil surface; two-ounce copper foil

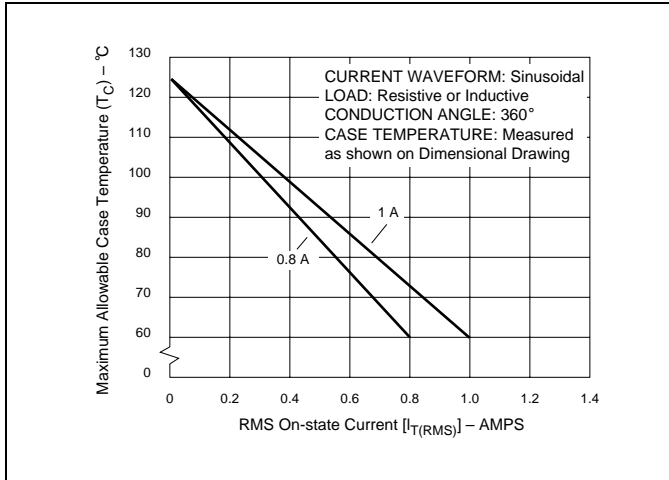

Figure E2.1 Maximum Allowable Case Temperature versus On-state Current (0.8 A and 1 A)

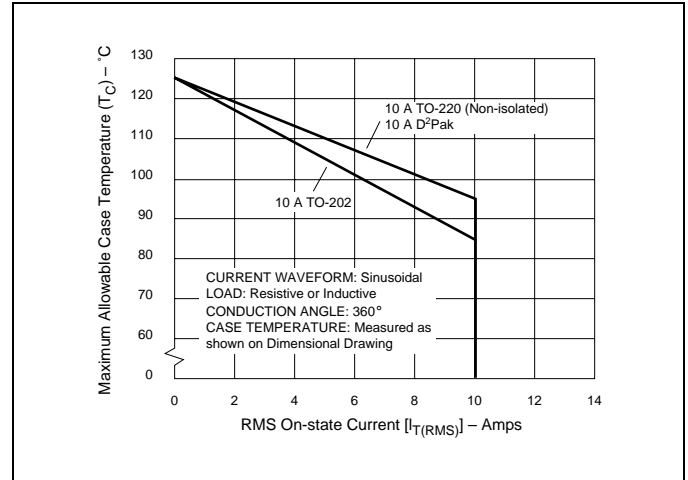

Figure E2.4 Maximum Allowable Case Temperature versus On-state Current (10 A)

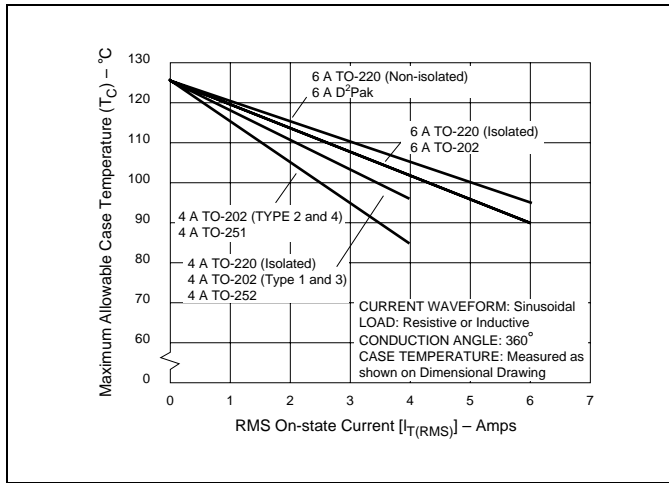

Figure E2.2 Maximum Allowable Case Temperature versus On-state Current (4 A and 6 A)

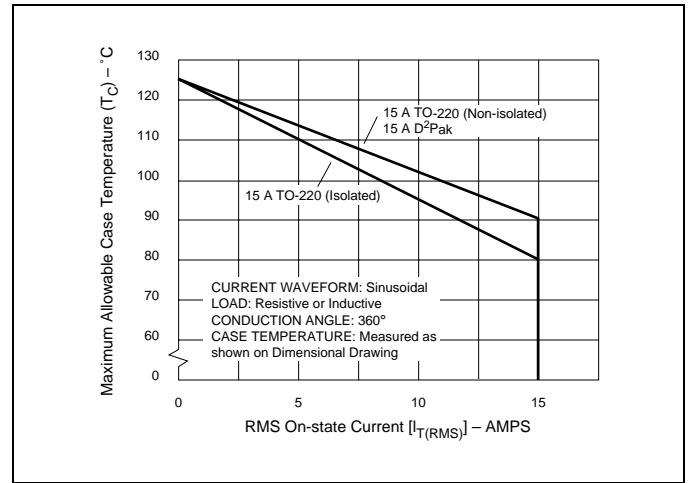

Figure E2.5 Maximum Allowable Case Temperature versus On-state Current (15 A)

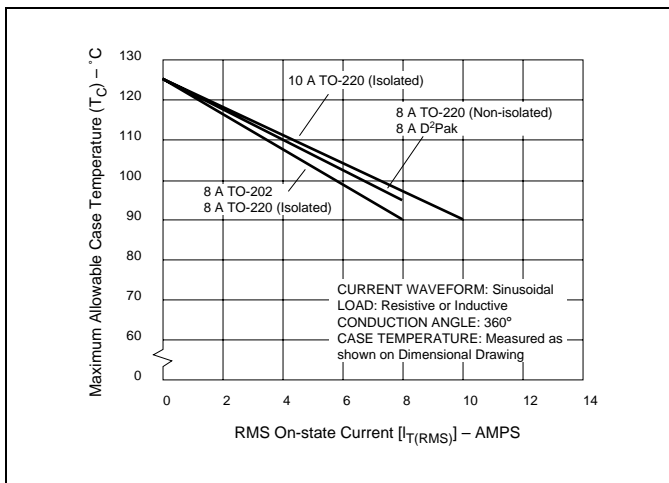

Figure E2.3 Maximum Allowable Case Temperature versus On-state Current (8 A and 10 A)

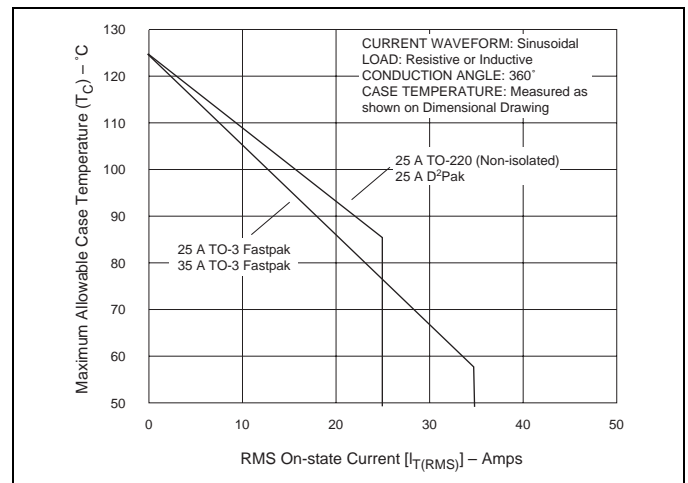

Figure E2.6 Maximum Allowable Case Temperature versus On-state Current (25 A and 35 A)

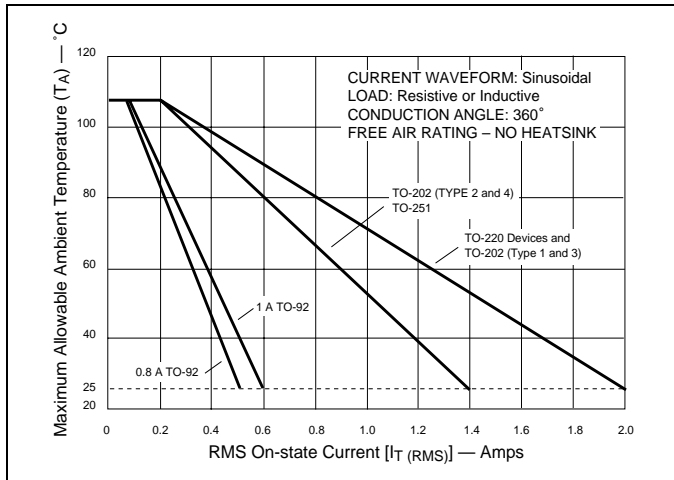

Figure E2.7 Maximum Allowable Ambient Temperature versus On-state Current

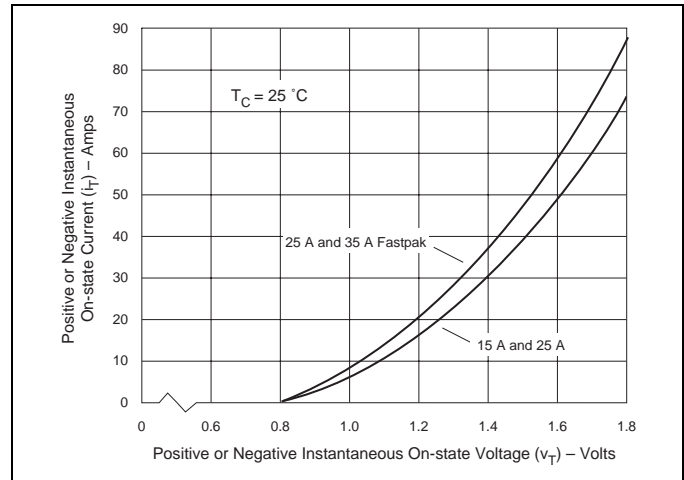

Figure E2.10 On-state Current versus On-state Voltage (Typical) (15 A and 25 A)

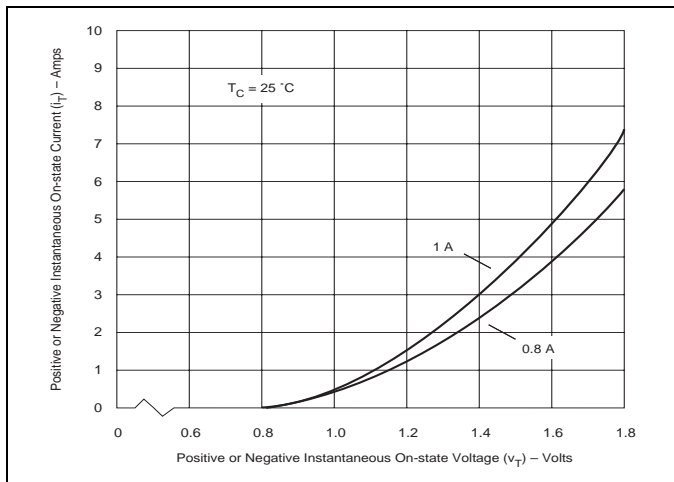

Figure E2.8 On-state Current versus On-state Voltage (Typical) (0.8 A and 1 A)

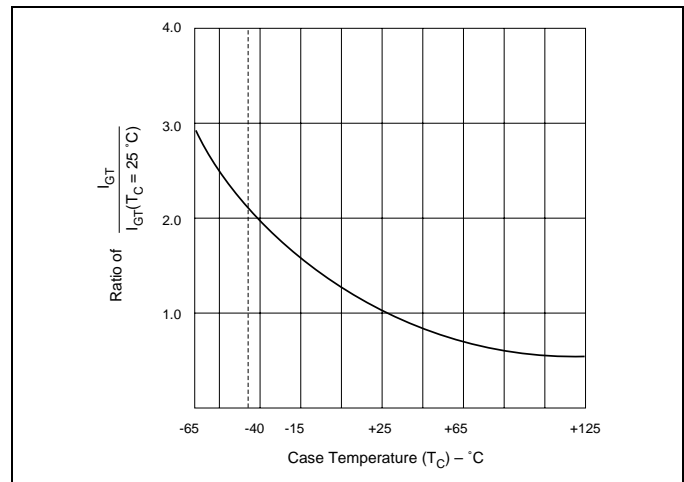

Figure E2.11 Normalized DC Gate Trigger Current for All Quadrants versus Case Temperature

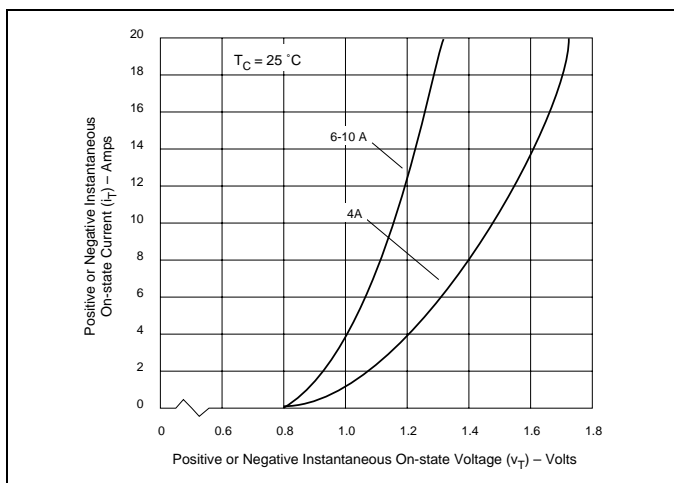

Figure E2.9 On-state Current versus On-state Voltage (Typical) (4 A, 6 A, 8 A, and 10 A)

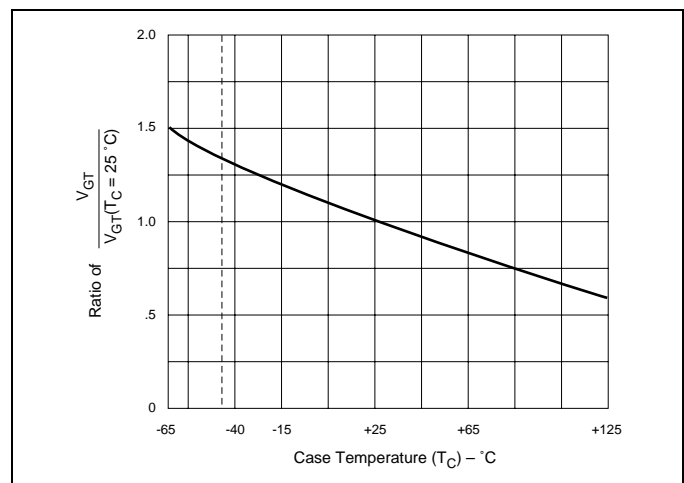

Figure E2.12 Normalized DC Gate Trigger Voltage for All Quadrants versus Case Temperature



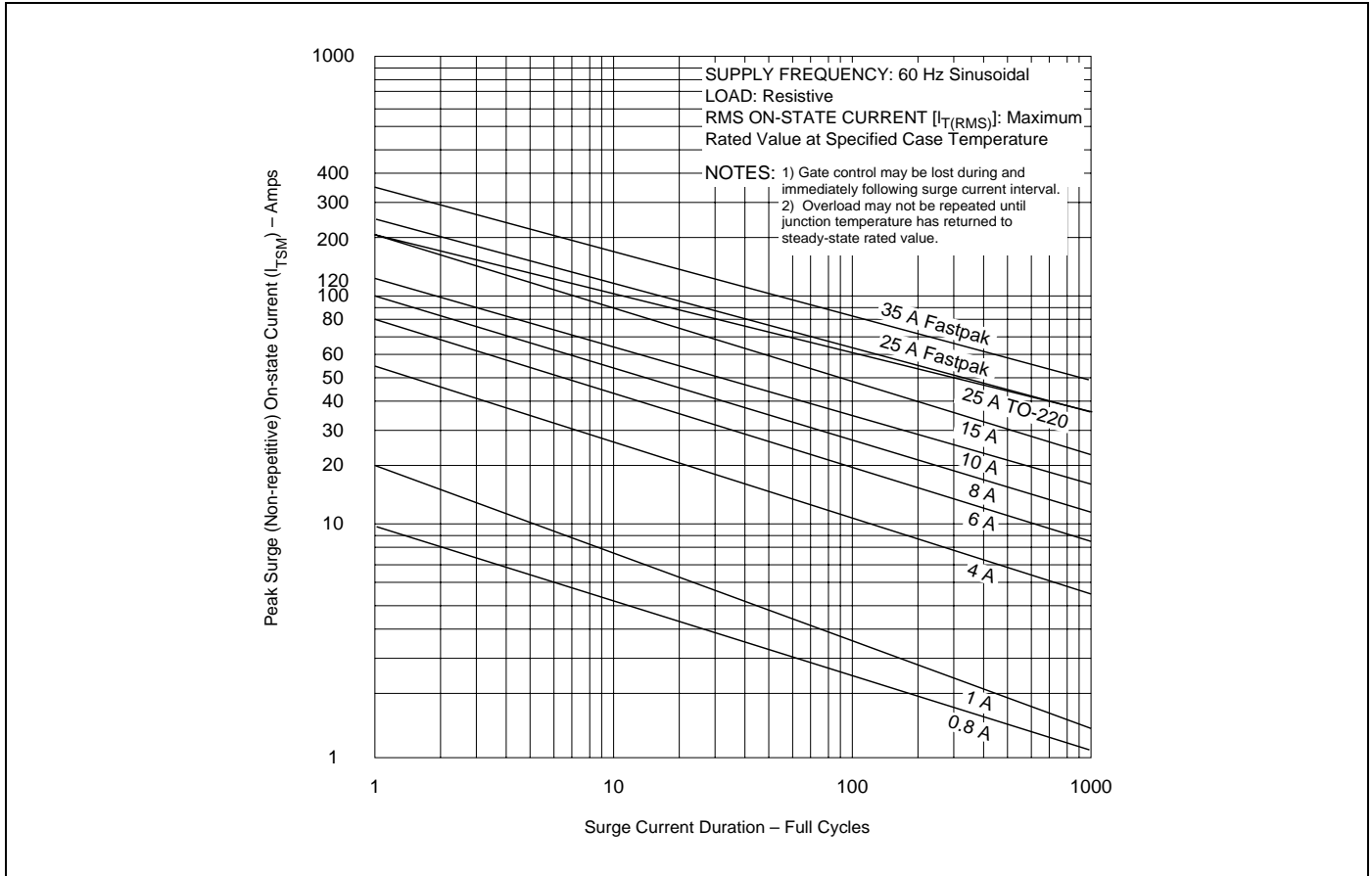

Figure E2.13 Peak Surge Current versus Surge Current Duration

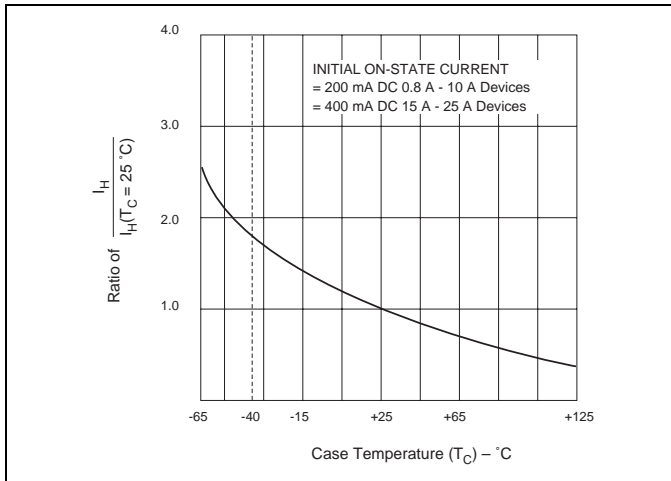

Figure E2.14 Normalized DC Holding Current versus Case Temperature

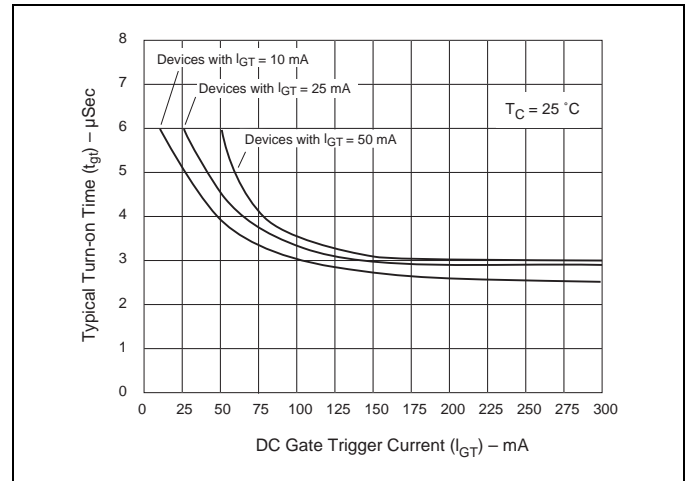

Figure E2.15 Turn-on Time versus Gate Trigger Current (Typical)

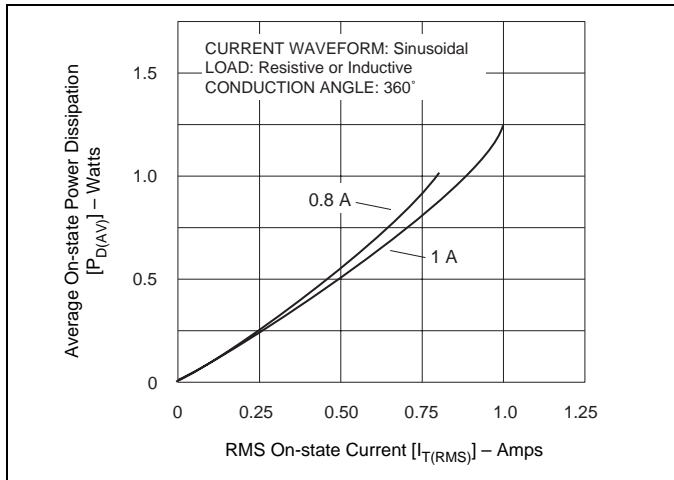

Figure E2.16 Power Dissipation (Typical) versus On-state Current (0.8 A and 1 A)

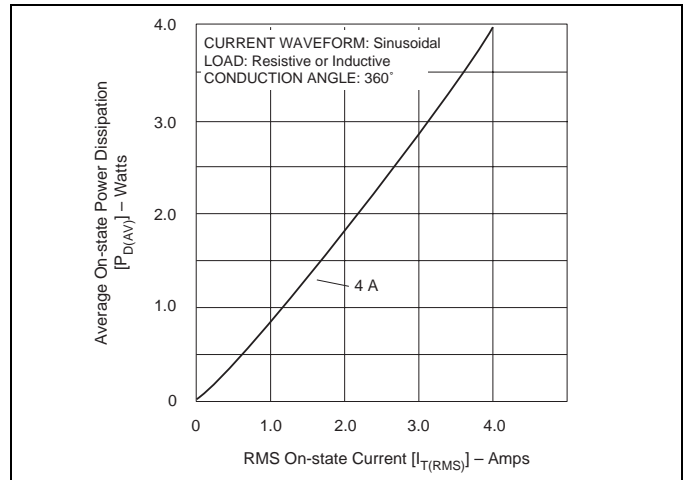

Figure E2.19 Power Dissipation (Typical) versus RMS On-state Current (4 A)

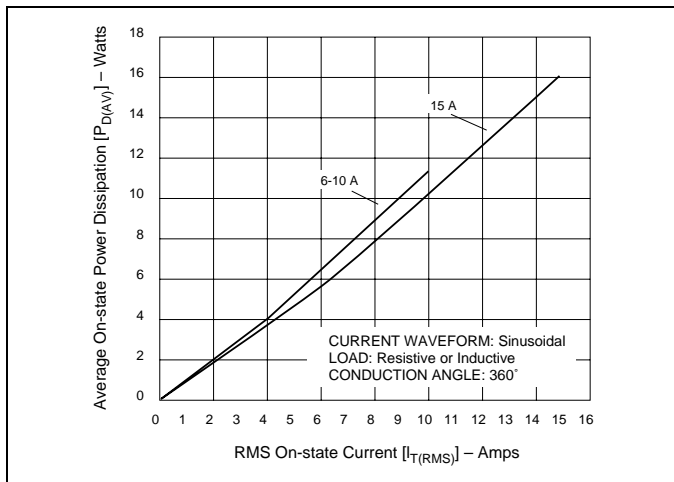

Figure E2.17 Power Dissipation (Typical) versus On-state Current (6 A to 10 A and 15 A)

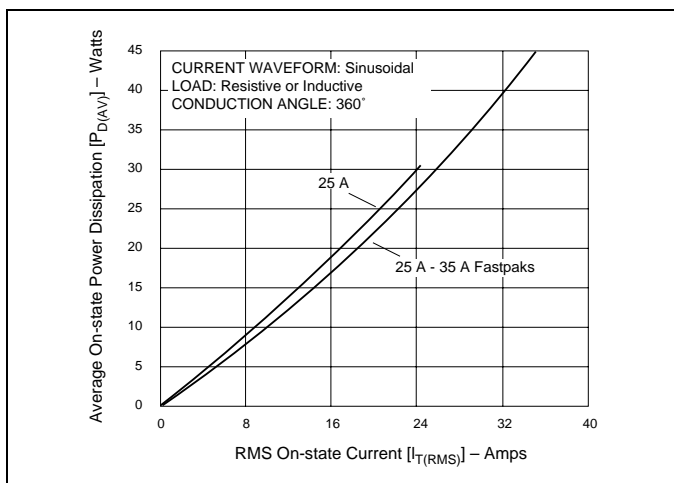

Figure E2.18 Power Dissipation (Typical) versus On-state Current (25 A to 35 A)

# Mouser Electronics

Authorized Distributor

Click to View Pricing, Inventory, Delivery & Lifecycle Information:

## Littelfuse:

[Q4010L4](#) [Q4010R5](#) [Q4010R4](#) [Q4010L5](#) [Q2004F341](#) [Q4004L352](#) [Q4004L359](#) [Q4008L4](#) [Q4006L4](#) [Q4006R4](#)  
[Q6025P5](#) [QK006L5](#) [Q4015R567](#) [Q8035P5](#) [Q8008R5](#) [Q2004F411](#) [Q401E4](#) [Q401E3](#) [Q6015R5](#) [QK025R5](#)  
[Q8010R5](#) [Q2004V4](#) [Q6004V3](#) [Q601E3](#) [Q601E4](#) [Q4015R5](#) [Q4015L5](#) [Q8008L5](#) [Q6008R5](#) [Q6008L5](#) [Q6004L452](#)  
[Q8004L452](#) [Q6025R667](#) [QK004L4](#) [Q2004F441](#) [QK006R5](#) [Q6025R5](#) [Q2004F42](#) [Q8010L5](#) [Q8010R4](#) [Q8010L4](#)  
[Q6025K681](#) [Q2008F443](#) [Q6X8E3](#) [Q6X8E4](#) [Q4008R4](#) [Q4004L3](#) [Q4004L4](#) [Q6010L5](#) [Q4025L659](#) [Q4025L658](#)  
[Q6025L659](#) [Q2004F32](#) [Q6008R567](#) [Q6008R559](#) [Q8006L5](#) [Q8004L4](#) [Q8006R5](#) [Q4010L555](#) [Q6010L568](#)  
[Q4010L553](#) [Q8025P5](#) [Q6040K781](#) [Q6035P5](#) [Q4010R552](#) [Q6025J681](#) [Q4025J681](#) [Q6008L559](#) [Q6008L555](#)  
[Q6015L5](#) [Q8015L5](#) [Q6040J781](#) [Q6010R4](#) [Q6010R5](#) [Q6010L4](#) [Q6004L4](#) [Q4X8E4](#) [Q6004L3](#) [Q4X8E3](#) [Q6006L5](#)  
[Q6015L552](#) [Q6015L556](#) [Q4015L558](#) [Q4015L556](#) [Q4015L559](#) [Q4015L555](#) [Q4015L553](#) [Q2006F441](#) [Q4025R5](#)  
[Q6008L556](#) [Q6016RH657](#) [Q4008R456](#) [Q6006R5](#) [Q6004V3TP](#) [Q4004V3TP](#) [Q6N3RP](#) [Q6X4RP](#) [Q4015N5RP](#)  
[Q6015N5RP](#) [Q4015N5TP](#)



**Стандарт  
Электрон  
Связь**

Мы молодая и активно развивающаяся компания в области поставок электронных компонентов. Мы поставляем электронные компоненты отечественного и импортного производства напрямую от производителей и с крупнейших складов мира.

Благодаря сотрудничеству с мировыми поставщиками мы осуществляем комплексные и плановые поставки широчайшего спектра электронных компонентов.

Собственная эффективная логистика и склад в обеспечивает надежную поставку продукции в точно указанные сроки по всей России.

Мы осуществляем техническую поддержку нашим клиентам и предпродажную проверку качества продукции. На все поставляемые продукты мы предоставляем гарантию .

Осуществляем поставки продукции под контролем ВП МО РФ на предприятия военно-промышленного комплекса России , а также работаем в рамках 275 ФЗ с открытием отдельных счетов в уполномоченном банке. Система менеджмента качества компании соответствует требованиям ГОСТ ISO 9001.

Минимальные сроки поставки, гибкие цены, неограниченный ассортимент и индивидуальный подход к клиентам являются основой для выстраивания долгосрочного и эффективного сотрудничества с предприятиями радиоэлектронной промышленности, предприятиями ВПК и научно-исследовательскими институтами России.

С нами вы становитесь еще успешнее!

**Наши контакты:**

**Телефон:** +7 812 627 14 35

**Электронная почта:** [sales@st-electron.ru](mailto:sales@st-electron.ru)

**Адрес:** 198099, Санкт-Петербург,  
Промышленная ул, дом № 19, литера Н,  
помещение 100-Н Офис 331