

**3.125 Gbps LVDS Buffers
with
Pre-emphasis and Equalization
(DS25BR100/110/120)
Evaluation Kit**

USER MANUAL

Part Number: DS25BR100EVK

For the latest documents concerning these products and evaluation kit, visit lvds.national.com. Schematics and gerber files are also available at lvds.national.com.

Table of Contents

Table of Contents	2
Overview	3
DS25BR100EVK Description.....	4
DS25BR100 (U1) Evaluation.....	5
DS25BR110 (U2) Evaluation.....	6
DS25BR120 (U3) Evaluation.....	7
Typical Performance	8

Overview

The DS25BR100EVK is an evaluation kit designed for demonstrating performance of the 3.125 Gbps LVDS Single Channel Buffers with Transmit Pre-emphasis and Receive Equalization family (DS25BR100, DS25BR110 and DS25BR120). The evaluation kit provides all three devices on a single board and three FR4 striplines (14 (~35), 28 (~75) and 42 (~105) inches (cm) in length) for exercising devices' signal conditioning features (pre-emphasis and equalization).

The purpose of this document is to: familiarize you with the DS25BR100EVK, suggest the test setup procedures and instrumentation, and guide you through some typical measurements that demonstrate performance of the chipset in typical applications.

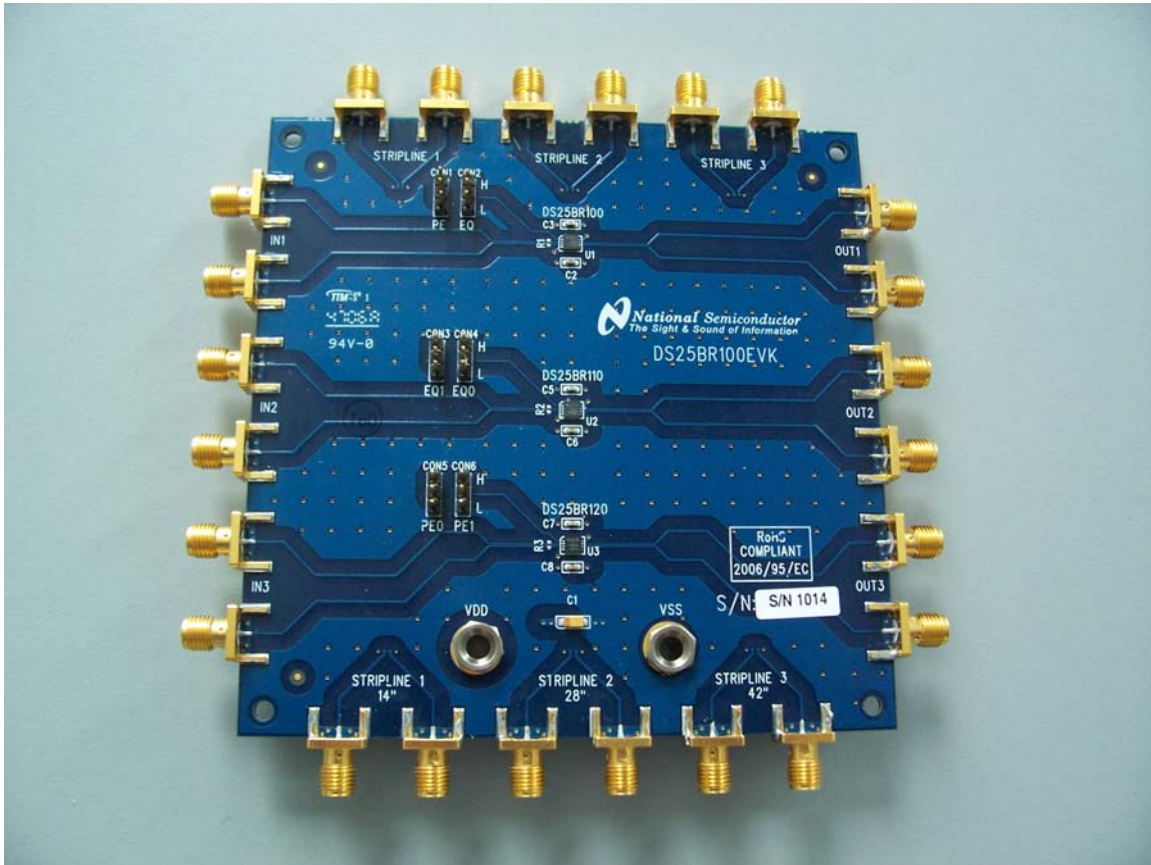

DS25BR100EVK Description

Figure 1 shows the top layer drawing of the PCB with the silkscreen annotations. It is a 4.5 by 4.5 inch eight-layer PCB that has a three-device layout capable of demonstrating performance and all features of the DS25BR100, DS25BR110 and DS25BR120. In addition, three microstrips allow easy evaluation of transmit pre-emphasis and receive equalization.

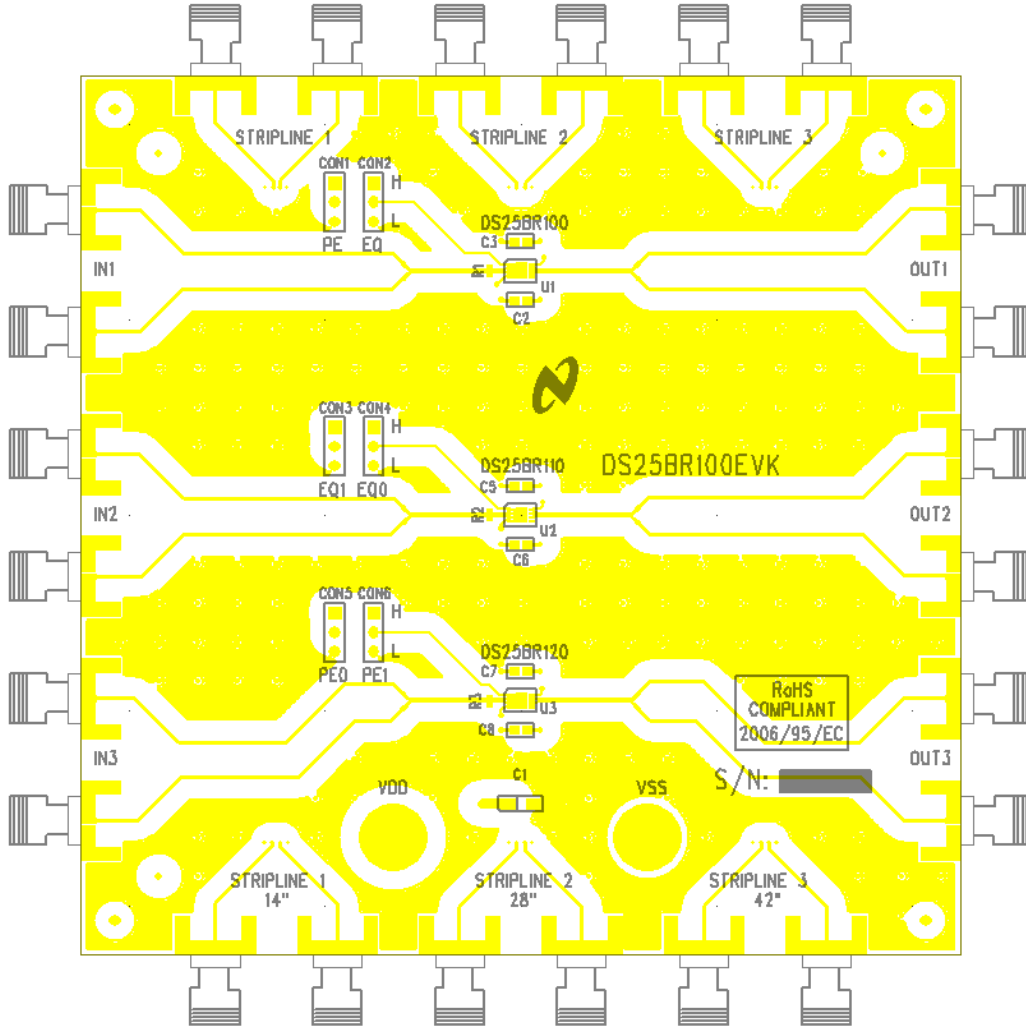

Figure 1. Driver Board

Connector	Device	Function
CON1, CON2	U1	Select PE or EQ Level
CON3, CON4	U2	Select EQ Level
CON5, CON6	U3	Select PE Level

Table 1. Driver Board Connector-Device-Function Cross Reference

DS25BR100 (U1) Evaluation

The DS25BR100 is a 3.125 Gbps LVDS buffer featuring two levels of transmit pre-emphasis (Off and Medium) and two levels of receive equalization (Low and Medium). The following is a recommended test setup procedure for the device evaluation. Figure 2 depicts a typical setup and instrumentation used for the device evaluation.

1. Apply the power to the device (3.3V typical) between VDD and VSS banana plug receptacles.
2. Connect desired STRIPLINE(s) to the input and / or output of the device using short 50-ohm coaxial cables (e.g. PE-SR402-AL from www.pasternack.com).
3. Connect a signal source (i.e. signal generator or an LVDS driver) to the IN1 inputs on the board and adjust the signal parameters (VOH, VOL, VCM) so that they comply with the device input recommendations.
4. Select equalization level by setting the EQ pin (CON2) to L (for Low setting) or H (for Medium setting).
5. If a STRIPLINE is connected to the device outputs, select pre-emphasis level by setting the PE pin (CON1) to L (for Off setting) or H (for Medium setting).
6. Connect the OUT1 outputs to an oscilloscope and view the output signals with an oscilloscope with the bandwidth of at least 5 GHz.

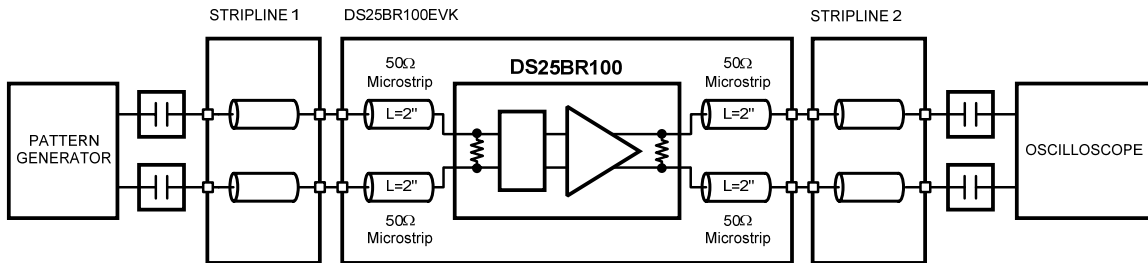

Figure 2. DS25BR100 Test Setup Example

DS25BR110 (U2) Evaluation

The DS25BR110 is a 3.125 Gbps LVDS buffer featuring four levels of receive equalization (Off, Low, Medium and High). The following is a recommended test setup procedure for the device evaluation. Figure 3 depicts a typical setup and instrumentation used for the device evaluation.

1. Apply the power to the device (3.3V typical) between VDD and VSS banana plug receptacles.
2. Connect desired STRIPLINE to the input of the device using short 50-ohm coaxial cables (e.g. PE-SR402-AL from www.pasternack.com).
3. Connect a signal source (i.e. signal generator or an LVDS driver) to the IN2 inputs on the board and adjust the signal parameters (VOH, VOL, VCM) so that they comply with the device input recommendations.
4. Select equalization level by setting the EQ0 (CON4) and EQ1 (CON3) pins to L or H. Refer to Table 2.

EQ1	EQ0	Equalization Level
0	0	Off
0	1	Low
1	0	Medium
1	1	High

Table 2. Equalization Level Selection

5. Connect the OUT2 outputs to an oscilloscope and view the output signals with an oscilloscope with the bandwidth of at least 5 GHz.

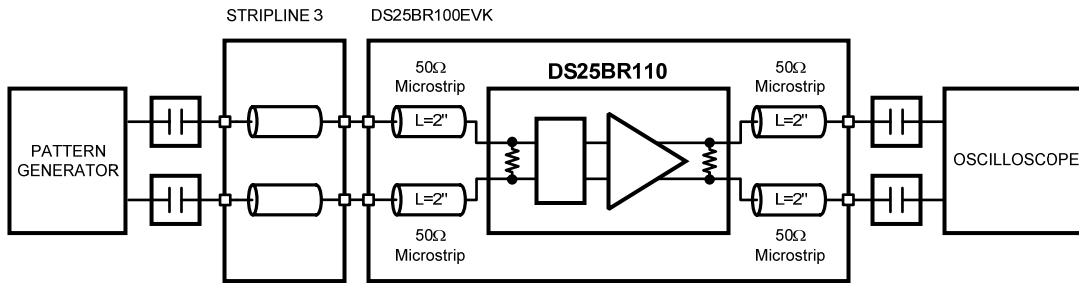

Figure 3. DS25BR110 Test Setup Example

DS25BR120 (U3) Evaluation

The DS25BR120 is a 3.125 Gbps LVDS buffer featuring four levels of transmit pre-emphasis (Off, Low, Medium and High). The following is a recommended test setup procedure for the device evaluation. Figure 4 depicts a typical setup and instrumentation used for the device evaluation.

1. Apply the power to the device (3.3V typical) between VDD and VSS banana plug receptacles.
2. Connect desired STRIPLINE to the output of the device using short 50-ohm coaxial cables (e.g. PE-SR402-AL from www.pasternack.com).
3. Connect a signal source (i.e. signal generator or an LVDS driver) to the IN3 inputs on the board and adjust the signal parameters (VOH, VOL, VCM) so that they comply with the device input recommendations.
4. Select pre-emphasis level by setting the PE0 (CON5) and PE1 (CON6) pins to L or H. Refer to Table 3.

PE1	PE0	Pre-emphasis Level
0	0	Off
0	1	Low
1	0	Medium
1	1	High

Table 3. Pre-emphasis Level Selection

5. Connect the OUT3 outputs to an oscilloscope and view the output signals with an oscilloscope with the bandwidth of at least 5 GHz.

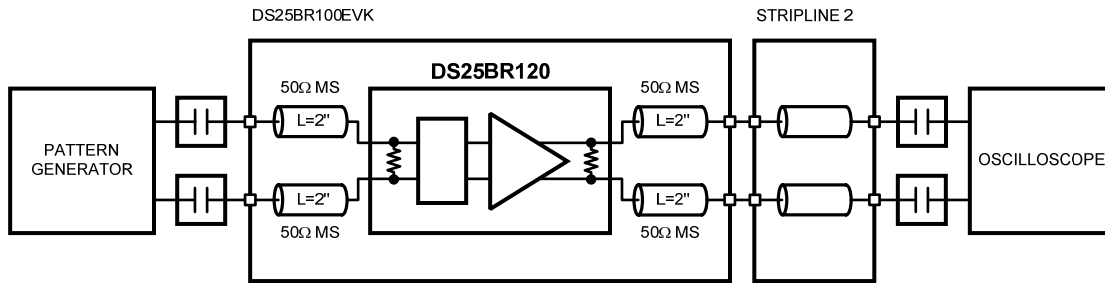
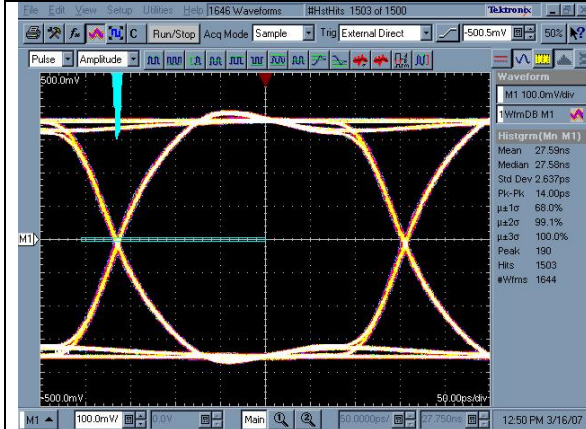

Figure 4. DS25BR120 Test Setup Example

Typical Performance

This section of the User Manual shows typical eye diagrams you can expect to see when evaluating the DS25BR100EVK.



The DS25BRxxx 3.125 Gbps PRBS-7 output eye diagram without any STRIPLINE connected and with PE/EQ = Off

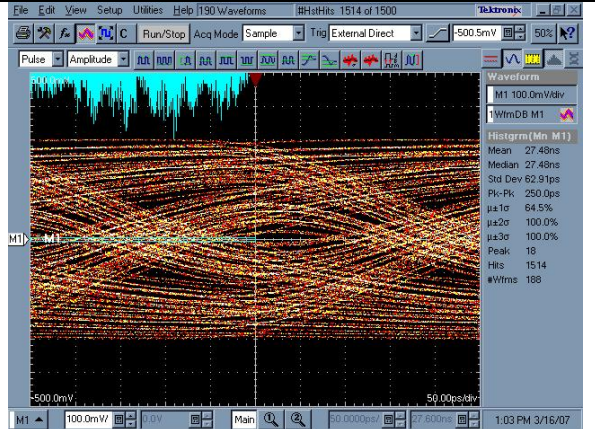

The DS25BRxxx 3.125 Gbps PRBS-7 output eye diagram after the STRIPLINE 3 and with PE/EQ = Off

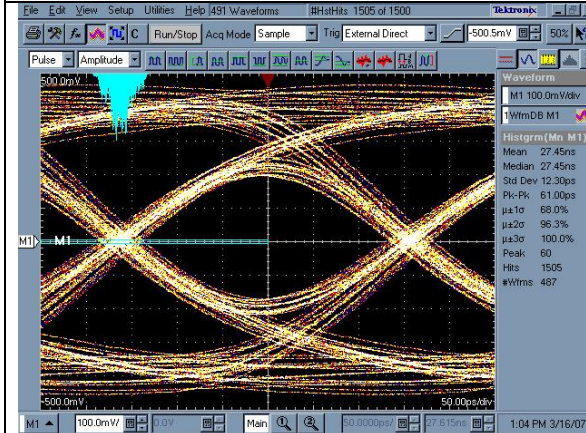

The DS25BR120 3.125 Gbps PRBS-7 output eye diagram after the STRIPLINE 3 and with PE = High. See Figure 4 for the Setup used.

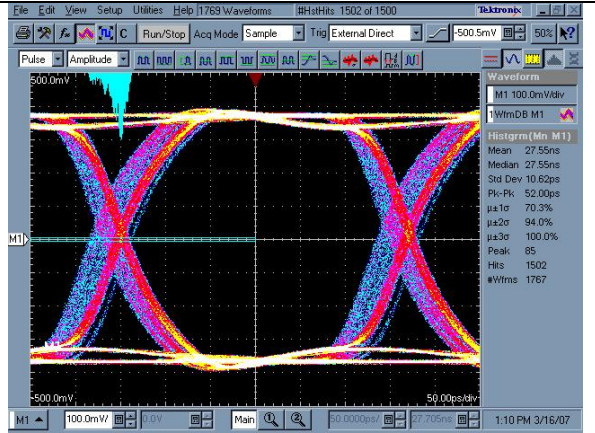

The DS25BR110 3.125 Gbps PRBS-7 output eye diagram after the STRIPLINE 3 and with EQ = High. See Figure 3 for the Setup used.

ENERCON - BILL OF MATERIALS		TITLE: NATIONAL SEMICONDUCTOR PCBA, DS25BR100EVK , ROHS	PL Number: Z3016-01	Rev: 2	Rev By: BJ	Rev Date: 3/1/2007	PL Status: Released
Main Product: PCBA, DS25BR100EVK , ROHS			Responsible Eng/Mgr:		Creator: Arlene Fox	Creation Date: 10/26/2006	

Item	Part Type	Part Number/Value	Mfg	NoSub	Description	Qty	SMT	Ref Des	Notes	Rev
1	PCB	P-05479R0			DS25BR100: 4.50x4.50x.062in, 8 layer	1			Bd: (114.30x 114.30mm) Panel: (4.50x13.70in) (114.30x 347.98mm) 3 bds/panel	0
2										
3	IC	DS25BR100TSD	NAT			1	X	U1	Customer Supplied	0
4	IC	DS25BR110TSD	NAT			1	X	U2	Customer Supplied	0
5	IC	DS25BR120TSD	NAT			1	X	U3	Customer Supplied	0
6										
7										
8	CAP	06035C103KAT	AVX		.01µF, 50V, ±10%, 0603, Ceramic, X7R, Pb-Free	3	X	C2,6,8		0
	<ALT>	C0603C103K5RAC	KEMET		.01µF, 50V, ±10%, 0603, Ceramic, X7R, Pb-Free					
	<ALT>	ECJ-1VB1H103K	PANA		.01µF, 50V, ±10%, 0603, Ceramic, X7R, Pb-Free					
9	CAP	0603YC104KAT	AVX		.1µF, 16V, ±10%, 0603, Ceramic, X7R, Pb- Free	3	X	C3,5,7		0
	<ALT>	C0603C104K3RAC	KEMET		.1µF, 25V, ±10%, 0603, Ceramic, X7R, Pb- Free					
	<ALT>	C0603C104K4RAC	KEMET		.1µF, 16V, ±10%, 0603, Ceramic, X7R, Pb- Free					
	<ALT>	ECJ-1VB1C104K	PANA		.1µF, 16V, ±10%, 0603, Ceramic, X7R, Pb- Free					
	<ALT>	ECJ-1VB1E104K	PANA		.1µF, 25V, ±10%, 0603, Ceramic, X7R, Pb- Free					
10	CAP	TAJA106K016	AVX		10µF, 16V, ±10%, A-Case, Tantalum, Pb- Free	1	X	C1		0
	<ALT>	T491A106K016AT	KEMET		10µF, 16V, ±10%, A-Case, Tantalum, Pb- Free					
11										

ENERCON - BILL OF MATERIALS	TITLE: NATIONAL SEMICONDUCTOR PCBA, DS25BR100EVK , ROHS	PL Number: Z3016-01	Rev: 2	Rev By: BJ	Rev Date: 3/1/2007	PL Status: Released
		Main Product: PCBA, DS25BR100EVK , ROHS		Responsible Eng/Mgr:	Creator: Arlene Fox	Creation Date: 10/26/2006

Item	Part Type	Part Number/Value	Mfg	NoSub	Description	Qty	SMT	Ref Des	Notes	Rev
12	CONN	142-0701-851	EMERSON		SMA, Jack Receptacle, 50 OHM, Pb-Free	24		SMA1-24		0
13	CONN	3267	POMONA		Banana, 1p, Female, Pb-Free	2		CON10,11		0
14	CONN	TSW-103-07-G-S	SAMTEC		Header, 3p, Male, .100"sp, Gold, Pb-Free	6		CON1-6		0
15										
16	STENCL	T-05481R0	ENERCON		STENCIL FABRICATION, DS25BR100-EVK, ROHS	1				0
17										
18	REF	C-05480R0	ENERCON		FABRICATION DWG, DS25BR100-EVK, ROHS					0
19	REF	S-05475R0	ENERCON		SCHEMATIC, DS25BR100-EVK, ROHS					0
20	REF	C-05491R0	ENERCON		PALLET DWG, DS25BR100-EVK, ROHS					0

Notes:

Do Not Stuff Resistors R1, R2, and R3

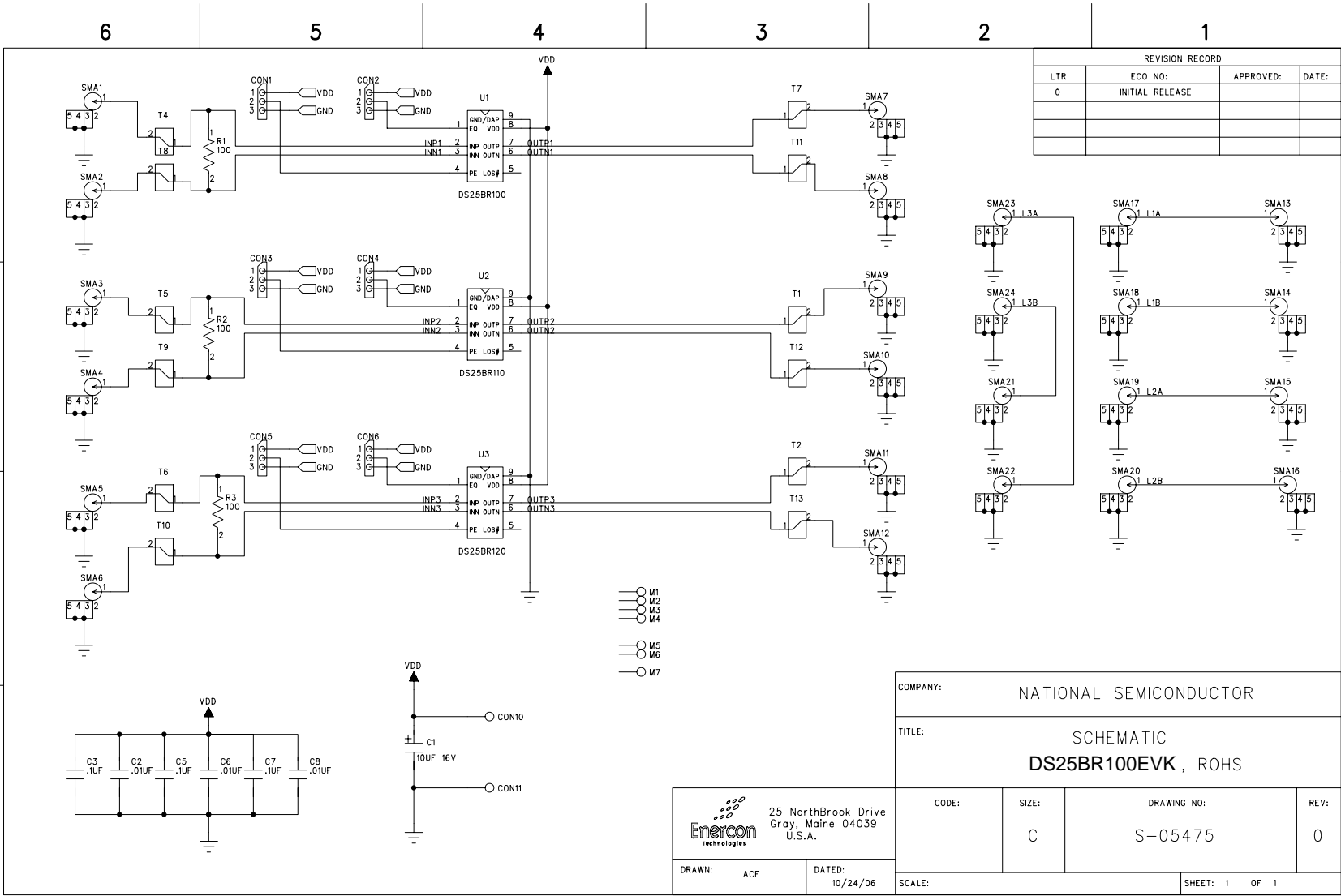

REVISION RECORD			
LTR	ECO NO:	APPROVED:	DATE:
0	INITIAL RELEASE		

COMPANY: NATIONAL SEMICONDUCTOR

TITLE: SCHEMATIC
DS25BR100EVK, ROHS

CODE:	SIZE:	DRAWING NO:	REV:
	C	S-05475	0
SCALE:		SHEET: 1 OF 1	

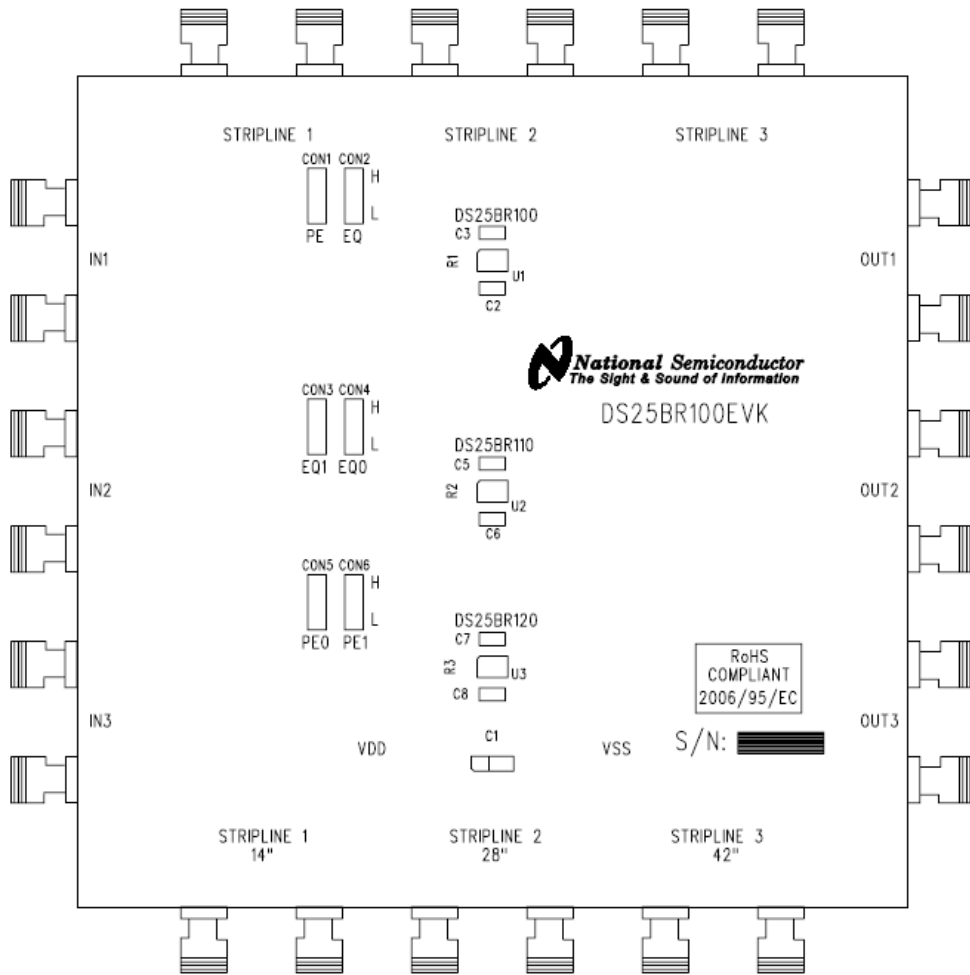

 25 NorthBrook Drive
 Gray, Maine 04039
 U.S.A.
 DRAWN: ACF DATED: 10/24/06

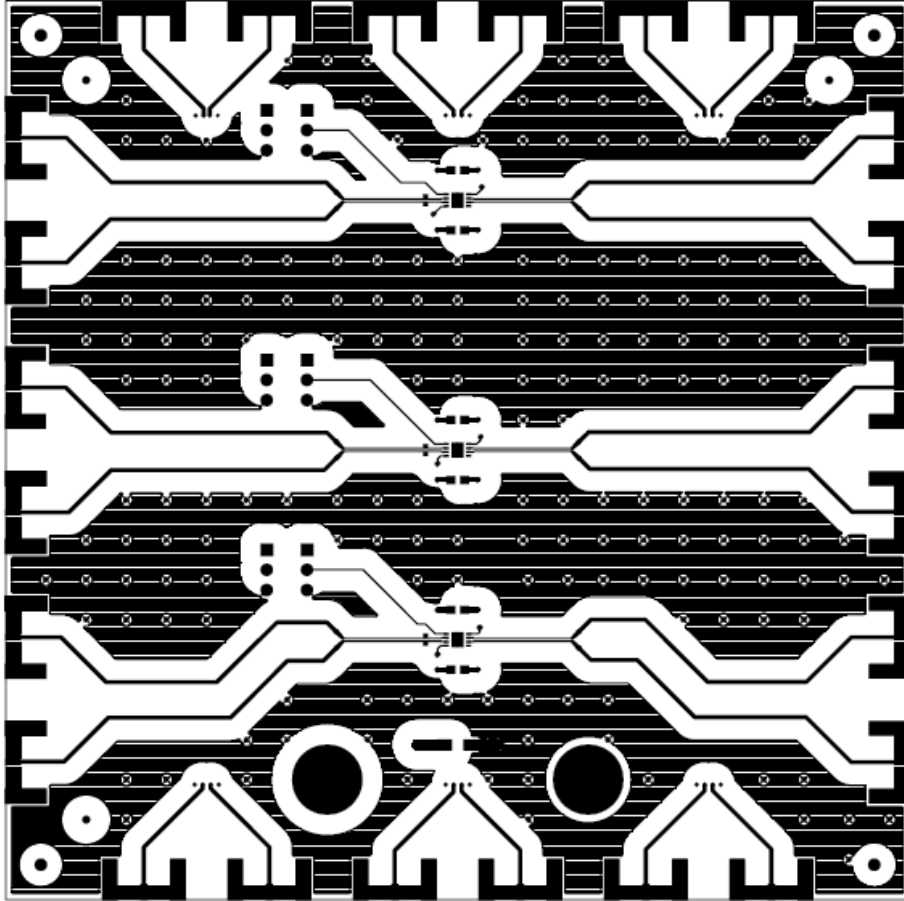

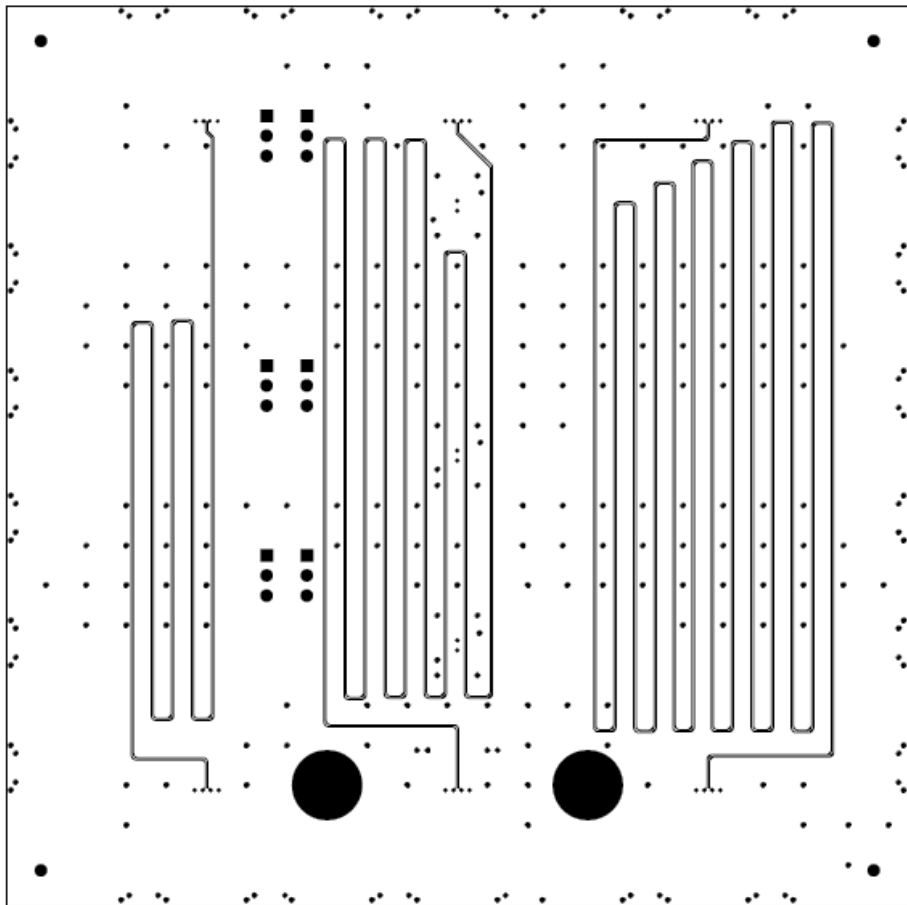

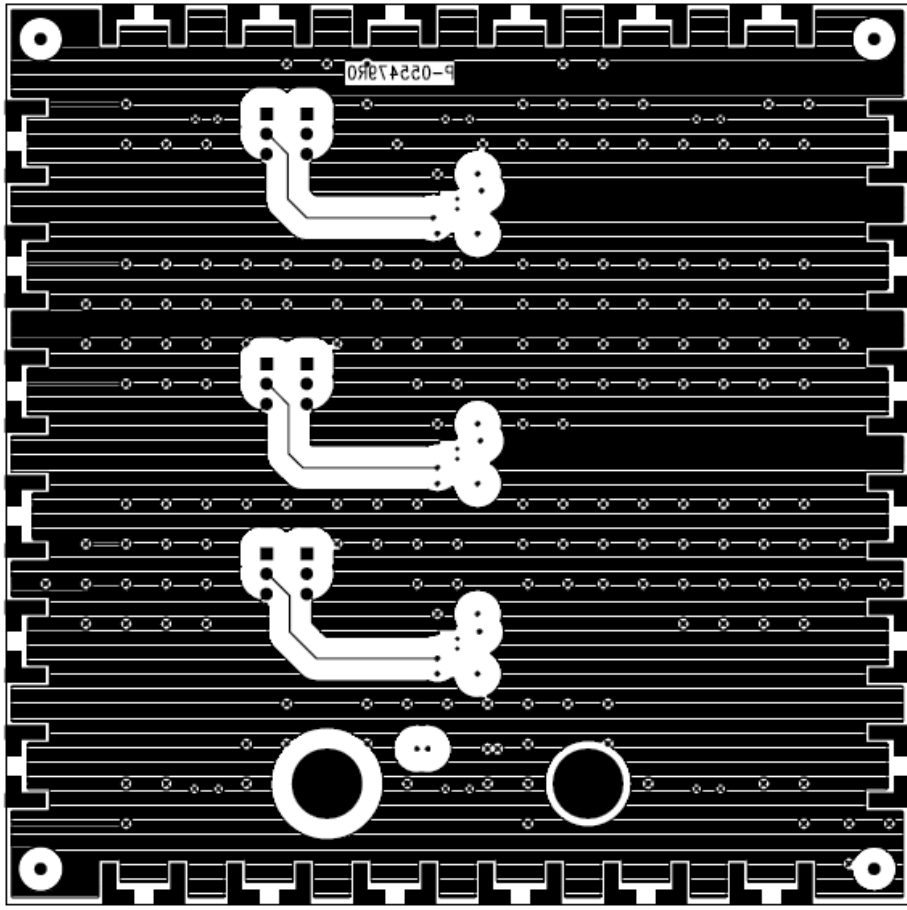

LAYER 6 SIGNAL



IMPORTANT NOTICE

Texas Instruments Incorporated and its subsidiaries (TI) reserve the right to make corrections, modifications, enhancements, improvements, and other changes to its products and services at any time and to discontinue any product or service without notice. Customers should obtain the latest relevant information before placing orders and should verify that such information is current and complete. All products are sold subject to TI's terms and conditions of sale supplied at the time of order acknowledgment.

TI warrants performance of its hardware products to the specifications applicable at the time of sale in accordance with TI's standard warranty. Testing and other quality control techniques are used to the extent TI deems necessary to support this warranty. Except where mandated by government requirements, testing of all parameters of each product is not necessarily performed.

TI assumes no liability for applications assistance or customer product design. Customers are responsible for their products and applications using TI components. To minimize the risks associated with customer products and applications, customers should provide adequate design and operating safeguards.

TI does not warrant or represent that any license, either express or implied, is granted under any TI patent right, copyright, mask work right, or other TI intellectual property right relating to any combination, machine, or process in which TI products or services are used. Information published by TI regarding third-party products or services does not constitute a license from TI to use such products or services or a warranty or endorsement thereof. Use of such information may require a license from a third party under the patents or other intellectual property of the third party, or a license from TI under the patents or other intellectual property of TI.

Reproduction of TI information in TI data books or data sheets is permissible only if reproduction is without alteration and is accompanied by all associated warranties, conditions, limitations, and notices. Reproduction of this information with alteration is an unfair and deceptive business practice. TI is not responsible or liable for such altered documentation. Information of third parties may be subject to additional restrictions.

Resale of TI products or services with statements different from or beyond the parameters stated by TI for that product or service voids all express and any implied warranties for the associated TI product or service and is an unfair and deceptive business practice. TI is not responsible or liable for any such statements.

TI products are not authorized for use in safety-critical applications (such as life support) where a failure of the TI product would reasonably be expected to cause severe personal injury or death, unless officers of the parties have executed an agreement specifically governing such use. Buyers represent that they have all necessary expertise in the safety and regulatory ramifications of their applications, and acknowledge and agree that they are solely responsible for all legal, regulatory and safety-related requirements concerning their products and any use of TI products in such safety-critical applications, notwithstanding any applications-related information or support that may be provided by TI. Further, Buyers must fully indemnify TI and its representatives against any damages arising out of the use of TI products in such safety-critical applications.

TI products are neither designed nor intended for use in military/aerospace applications or environments unless the TI products are specifically designated by TI as military-grade or "enhanced plastic." Only products designated by TI as military-grade meet military specifications. Buyers acknowledge and agree that any such use of TI products which TI has not designated as military-grade is solely at the Buyer's risk, and that they are solely responsible for compliance with all legal and regulatory requirements in connection with such use.

TI products are neither designed nor intended for use in automotive applications or environments unless the specific TI products are designated by TI as compliant with ISO/TS 16949 requirements. Buyers acknowledge and agree that, if they use any non-designated products in automotive applications, TI will not be responsible for any failure to meet such requirements.

Following are URLs where you can obtain information on other Texas Instruments products and application solutions:

Products

Audio	www.ti.com/audio
Amplifiers	amplifier.ti.com
Data Converters	dataconverter.ti.com
DLP® Products	www.dlp.com
DSP	dsp.ti.com
Clocks and Timers	www.ti.com/clocks
Interface	interface.ti.com
Logic	logic.ti.com
Power Mgmt	power.ti.com
Microcontrollers	microcontroller.ti.com
RFID	www.ti-rfid.com
OMAP Mobile Processors	www.ti.com/omap
Wireless Connectivity	www.ti.com/wirelessconnectivity

Applications

Automotive and Transportation	www.ti.com/automotive
Communications and Telecom	www.ti.com/communications
Computers and Peripherals	www.ti.com/computers
Consumer Electronics	www.ti.com/consumer-apps
Energy and Lighting	www.ti.com/energy
Industrial	www.ti.com/industrial
Medical	www.ti.com/medical
Security	www.ti.com/security
Space, Avionics and Defense	www.ti.com/space-avionics-defense
Video and Imaging	www.ti.com/video

TI E2E Community Home Page

e2e.ti.com

Mailing Address: Texas Instruments, Post Office Box 655303, Dallas, Texas 75265
Copyright © 2012, Texas Instruments Incorporated



Стандарт Электрон Связь

Мы молодая и активно развивающаяся компания в области поставок электронных компонентов. Мы поставляем электронные компоненты отечественного и импортного производства напрямую от производителей и с крупнейших складов мира.

Благодаря сотрудничеству с мировыми поставщиками мы осуществляем комплексные и плановые поставки широчайшего спектра электронных компонентов.

Собственная эффективная логистика и склад в обеспечивает надежную поставку продукции в точно указанные сроки по всей России.

Мы осуществляем техническую поддержку нашим клиентам и предпродажную проверку качества продукции. На все поставляемые продукты мы предоставляем гарантию .

Осуществляем поставки продукции под контролем ВП МО РФ на предприятия военно-промышленного комплекса России , а также работаем в рамках 275 ФЗ с открытием отдельных счетов в уполномоченном банке. Система менеджмента качества компании соответствует требованиям ГОСТ ISO 9001.

Минимальные сроки поставки, гибкие цены, неограниченный ассортимент и индивидуальный подход к клиентам являются основой для выстраивания долгосрочного и эффективного сотрудничества с предприятиями радиоэлектронной промышленности, предприятиями ВПК и научно-исследовательскими институтами России.

С нами вы становитесь еще успешнее!

Наши контакты:

Телефон: +7 812 627 14 35

Электронная почта: sales@st-electron.ru

Адрес: 198099, Санкт-Петербург,
Промышленная ул, дом № 19, литера Н,
помещение 100-Н Офис 331