

High Voltage IGBT

IXGH 16N170A
IXGT 16N170A
IXGH 16N170AH1
IXGT 16N170AH1

V_{CES} = 1700 V
I_{C25} = 16 A
V_{CE(sat)} = 5.0 V
t_{fi(typ)} = 70 ns

Preliminary Data Sheet

Symbol	Test Conditions	Maximum Ratings
V _{CES}	T _J = 25°C to 150°C	1700 V
V _{CGR}	T _J = 25°C to 150°C; R _{GE} = 1 MΩ	1700 V
V _{GES}	Continuous	±20 V
V _{GEM}	Transient	±30 V
I _{C25}	T _C = 25°C	16 A
I _{C90}	T _C = 90°C	11 A
I _{F90}	T _C = 90°C, Diode	17 A
I _{CM}	T _C = 25°C, 1 ms	40 A
SSOA (RBSOA)	V _{GE} = 15 V, T _{VJ} = 125°C, R _G = 10Ω Clamped inductive load	I _{CM} = 40 A @ 0.8 V _{CES}
t _{SC}	T _J = 125°C, V _{CE} = 1200 V; V _{GE} = 15 V, R _G = 22Ω	10 μs
P _C	T _C = 25°C	190 W
T _J		-55 ... +150 °C
T _{JM}		150 °C
T _{stg}		-55 ... +150 °C
M _d	Mounting torque (M3)	TO-247 1.13/10Nm/lb.in.
	Maximum lead temperature for soldering 1.6 mm (0.062 in.) from case for 10 s	300 °C
	Plastic body for 10s	260 °C
Weight		TO-247 6 g TO-268 4 g

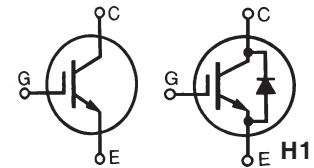

TO-268 (IXGT)

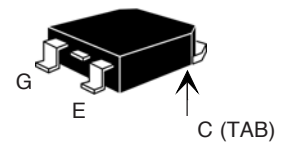

TO-247 (IXGH)

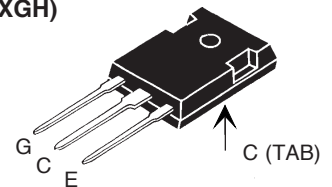

G = Gate
E = Emitter
C = Collector,
TAB = Collector

Features

- High blocking voltage
- High current handling capability
- MOS Gate turn-on - drive simplicity
- Rugged NPT structure
- Molding epoxies meet UL 94 V-0 flammability classification
- SONIC-FRD™ fast recovery copack diode
- International standard packages JEDEC TO-268 and JEDEC TO-247 AD

Applications

- Capacitor discharge & pulser circuits
- AC motor speed control
- DC servo and robot drives
- DC choppers
- Uninterruptible power supplies (UPS)
- Switched-mode and resonant-mode power supplies

Advantages

- High power density
- Suitable for surface mounting
- Easy to mount with 1 screw, (isolated mounting screw hole)

Symbol	Test Conditions	Characteristic Values (T _J = 25°C, unless otherwise specified)		
		min.	typ.	max.
BV _{CES}	I _C = 250 μA, V _{GE} = 0 V	1700		V
V _{GE(th)}	I _C = 250 μA, V _{CE} = V _{GE}	3.0		V
I _{CES}	V _{CE} = 0.8 · V _{CES} V _{GE} = 0 V, Note 1 T _J = 125°C	16N170A		50 μA
		16N170AH1		100 μA
		16N170A		750 μA
		16N170AH1		1.5 mA
I _{GES}	V _{CE} = 0 V, V _{GE} = ±20 V			±100 nA
V _{CE(sat)}	I _C = I _{C90} , V _{GE} = 15 V T _J = 125°C		4.0	V
			4.8	V

Symbol	Test Conditions	Characteristic Values ($T_J = 25^\circ\text{C}$ unless otherwise specified)		
		min.	typ.	max.
g_{fs}	$I_C = I_{C25}; V_{CE} = 10\text{ V}$ Note 2	7	13	S
C_{ies}	$V_{CE} = 25\text{ V}, V_{GE} = 0\text{ V}, f = 1\text{ MHz}$	16N170A 16N170AH1	1620	pF
C_{oes}			83	pF
C_{res}			31	pF
Q_g	$I_C = I_{C90}; V_{GE} = 15\text{ V}, V_{CE} = 0.5 V_{CES}$	16N170A 16N170AH1	83	nC
Q_{ge}			10	nC
Q_{gc}			31	nC
$t_{d(on)}$	Inductive load, $T_J = 25^\circ\text{C}$	16N170A 16N170AH1	36	ns
t_{ri}	$I_C = I_{C25}, V_{GE} = 15\text{ V}, R_G = 10\ \Omega$		57	ns
$t_{d(off)}$	$V_{CE} = 0.5 V_{CES}$, Note 3		160	300 ns
t_{fi}			70	150 ns
E_{off}			0.85	1.5 mJ
$t_{d(on)}$	Inductive load, $T_J = 125^\circ\text{C}$		38	ns
t_{ri}	$I_C = I_{C25}, V_{GE} = 15\text{ V}, R_G = 10\ \Omega$	59	ns	
E_{on}	$V_{CE} = 0.5 V_{CES}$, Note 3	1.5	mJ	
		2.5	mJ	
$t_{d(off)}$		175	ns	
t_{fi}		155	ns	
E_{off}		2.0	mJ	
R_{thJC}			0.65	KW
R_{thCK}	(TO-247)	0.25		KW

Reverse Diode (FRED)
Characteristic Values

Symbol	Test Conditions ($T_J = 25^\circ\text{C}$ unless otherwise specified)	min.	typ.	max.	
V_F	$I_F = 20\text{ A}, V_{GE} = 0\text{ V}$, Note 2		2.5	2.9	V
				$T_J = 125^\circ\text{C}$	2.5
t_{rr}	$I_F = 20\text{ A}, V_{GE} = 0\text{ V}, -di_F/dt = 450\text{ A}/\mu\text{s}$ $V_R = 1200\text{ V}$		230		ns
				$T_J = 125^\circ\text{C}$	400
I_{RM}			23		A
				$T_J = 125^\circ\text{C}$	27
R_{thJC}				0.9	KW

- Notes: 1. Device must be heatsunk for high temperature leakage current measurements to avoid thermal runaway.
 2. Pulse test, $t \leq 300\ \mu\text{s}$, duty cycle $\leq 2\%$
 3. Switching times may increase for $V_{CE}(\text{Clamp}) > 0.8 \cdot V_{CES}$, higher T_J or increased R_G .

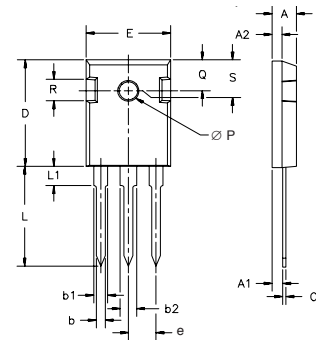
TO-247 AD Outline

Dim.	Millimeter		Inches	
	Min.	Max.	Min.	Max.
A	4.7	5.3	.185	.209
A ₁	2.2	2.54	.087	.102
A ₂	2.2	2.6	.059	.098
b	1.0	1.4	.040	.055
b ₁	1.65	2.13	.065	.084
b ₂	2.87	3.12	.113	.123
C	.4	.8	.016	.031
D	20.80	21.46	.819	.845
E	15.75	16.26	.610	.640
e	5.20	5.72	0.205	0.225
L	19.81	20.32	.780	.800
L1		4.50		.177
∅P	3.55	3.65	.140	.144
Q	5.89	6.40	0.232	0.252
R	4.32	5.49	.170	.216
S	6.15	BSC	242	BSC

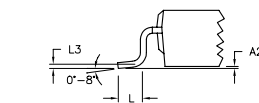
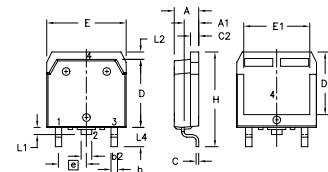
TO-268 Outline

Dim.	Millimeter		Inches	
	Min.	Max.	Min.	Max.
A	4.9	5.1	.193	.201
A ₁	2.7	2.9	.106	.114
A ₂	.02	.25	.001	.010
b	1.15	1.45	.045	.057
b ₂	1.9	2.1	.75	.83
C	.4	.65	.016	.026
D	13.80	14.00	.543	.551
E	15.85	16.05	.624	.632
E ₁	13.3	13.6	.524	.535
e	5.45	BSC	.215	BSC
H	18.70	19.10	.736	.752
L	2.40	2.70	.094	.106
L1	1.20	1.40	.047	.055
L2	1.00	1.15	.039	.045
L3		0.25		.010
L4	3.80	4.10	.150	.161

IXYS reserves the right to change limits, test conditions, and dimensions.

IXYS MOSFETs and IGBTs are covered by one or more of the following U.S. patents:	4,835,592	4,931,844	5,049,961	5,237,481	6,162,665	6,404,065 B1	6,683,344	6,727,585
	4,850,072	5,017,508	5,063,307	5,381,025	6,259,123 B1	6,534,343	6,710,405 B2	6,759,692
	4,881,106	5,034,796	5,187,117	5,486,715	6,306,728 B1	6,583,505	6,710,463	6,771,478 B2

Fig. 1. Output Characteristics
@ 25 °C

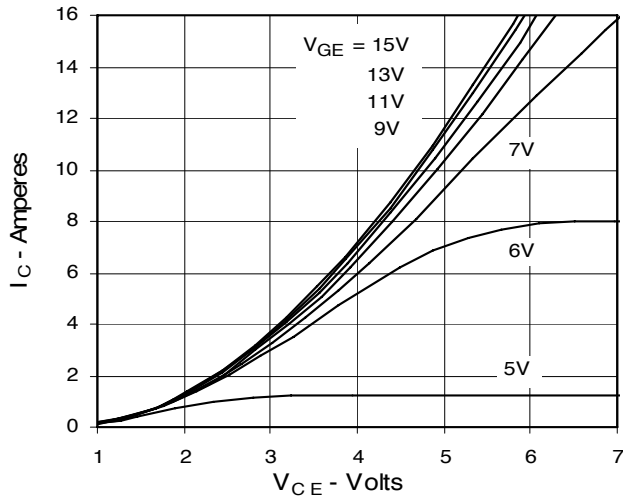

Fig. 2. Extended Output Characteristics
@ 25 °C

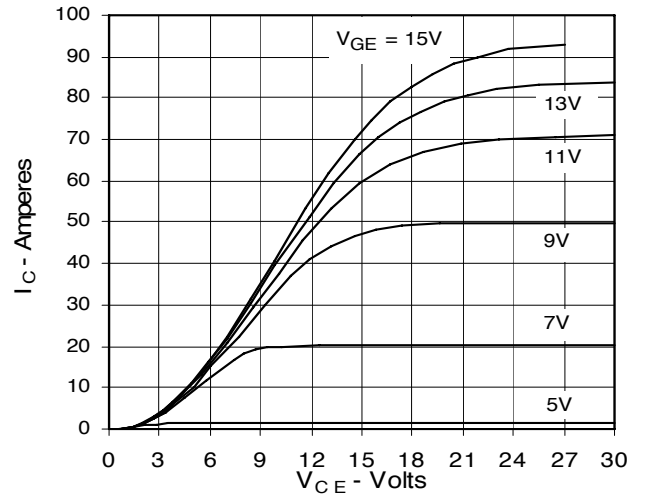

Fig. 3. Output Characteristics
@ 125 °C

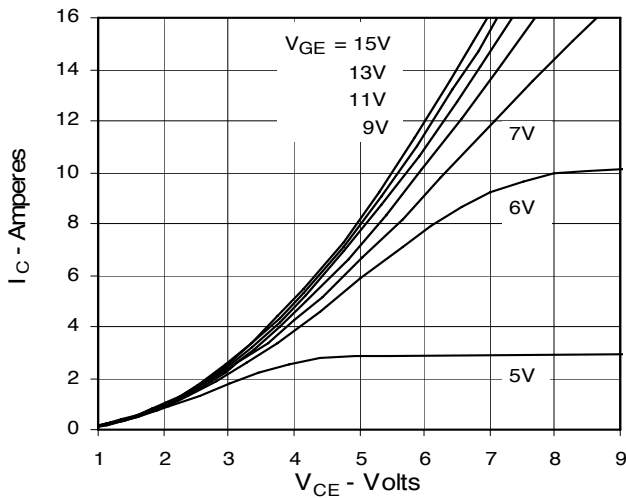

Fig. 4. Dependence of $V_{CE(sat)}$ on Temperature

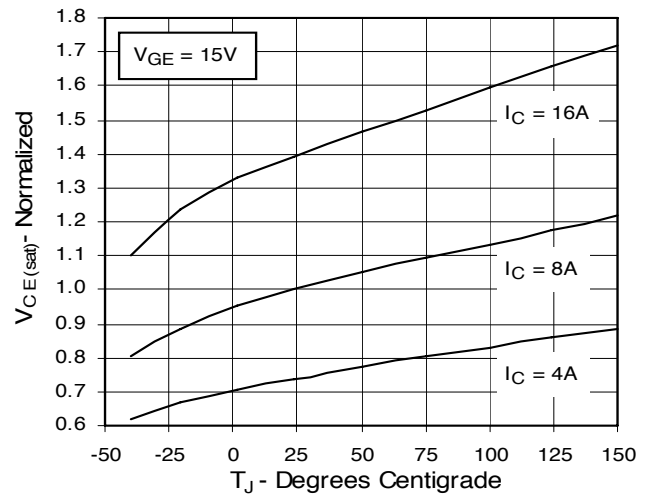

Fig. 5. Collector-to-Emitter Voltage vs. Gate-to-Emitter voltage

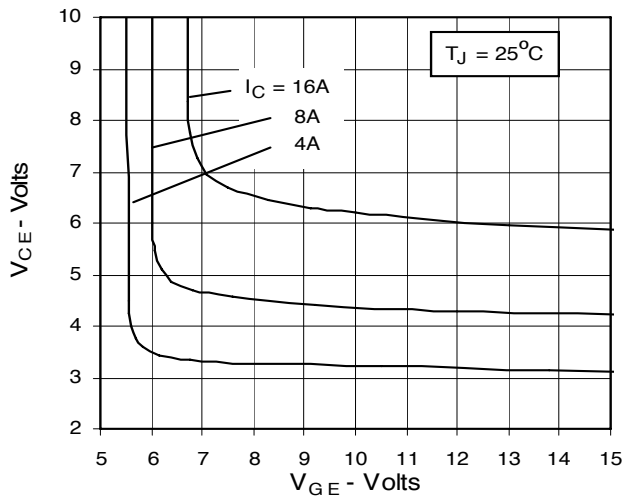

Fig. 6. Input Admittance

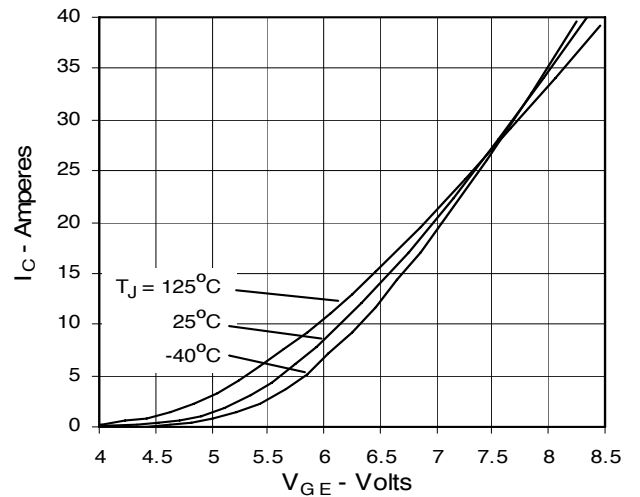

Fig. 7. Transconductance

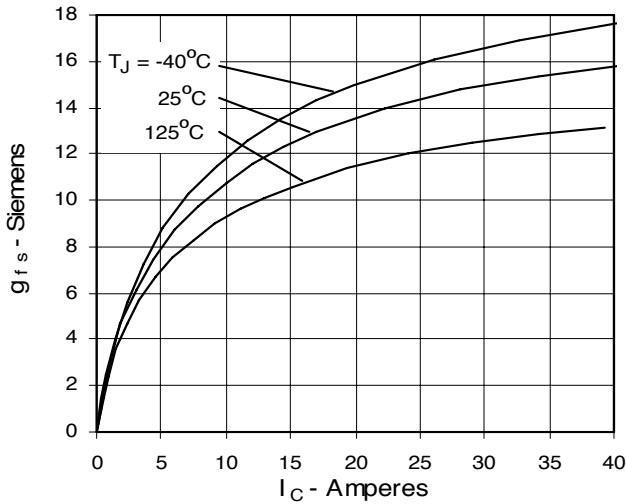

Fig. 8. Dependence of Turn-off Energy Loss on R_G

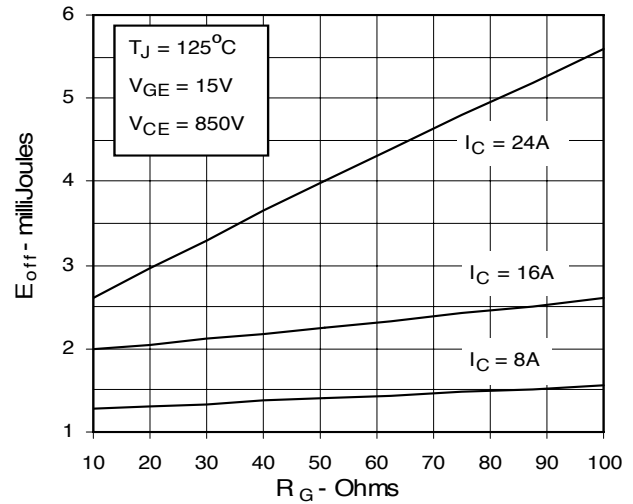

Fig. 9. Dependence of Turn-Off Energy Loss on I_C

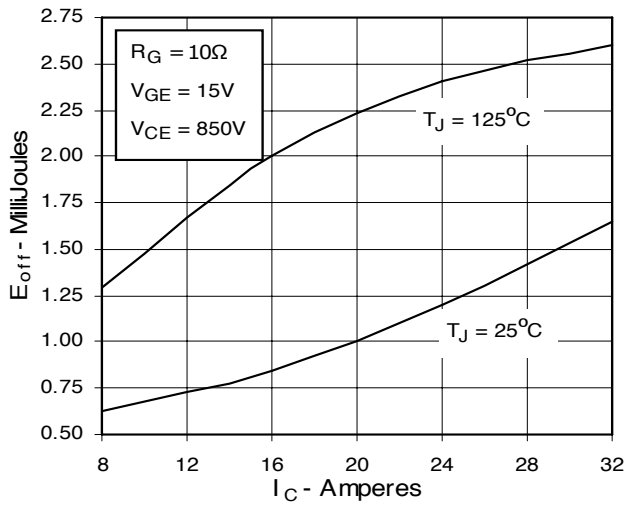

Fig. 10. Dependence of Turn-off Energy Loss on Temperature

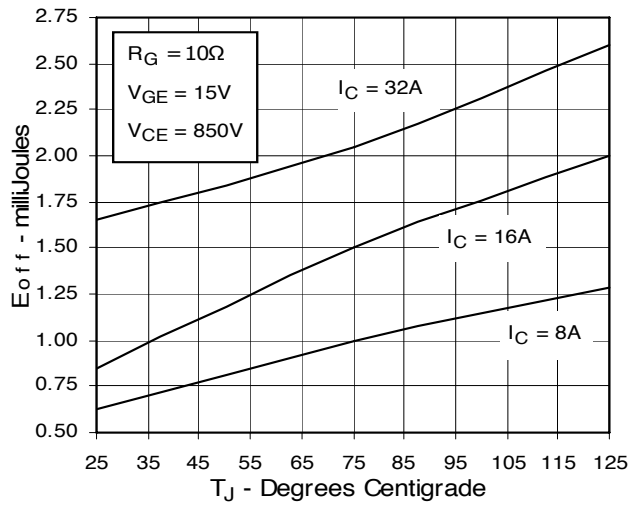

Fig. 11. Dependence of Turn-off Switching Time on R_G

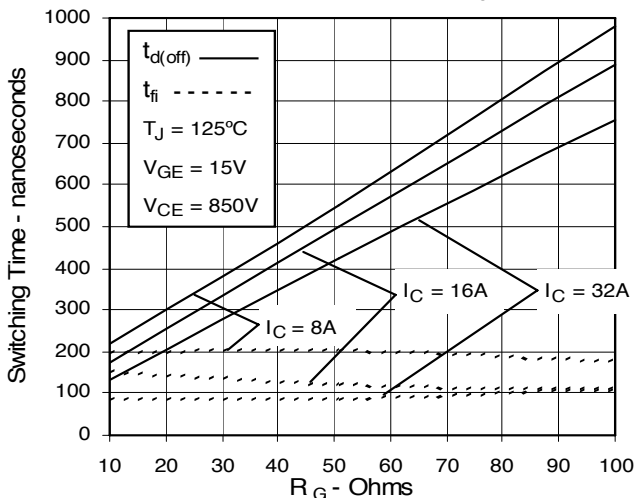

Fig. 12. Dependence of Turn-off Switching Time on I_C

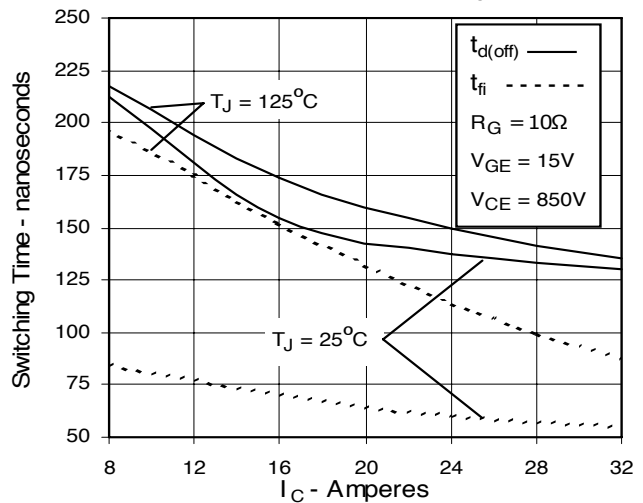

Fig. 13. Dependence of Turn-off Switching Time on Temperature

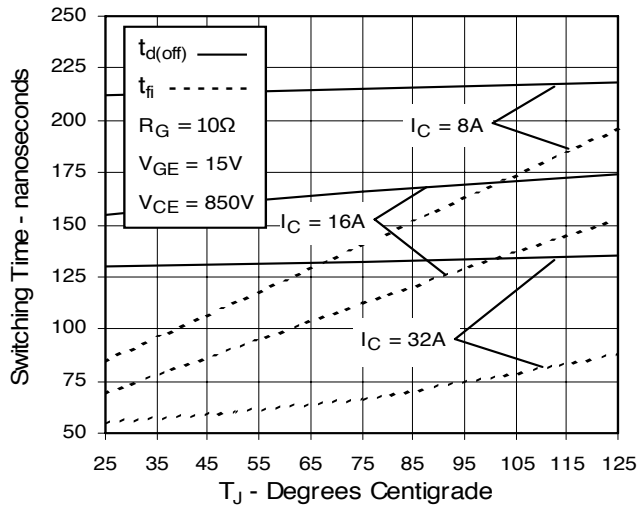

Fig. 14. Gate Charge

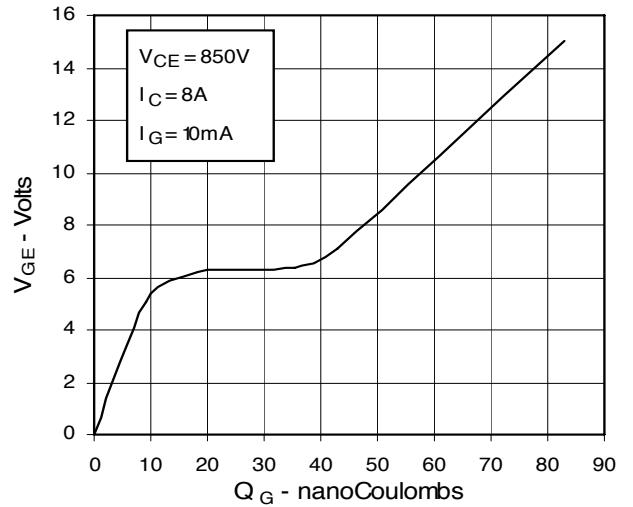

Fig. 15. Capacitance

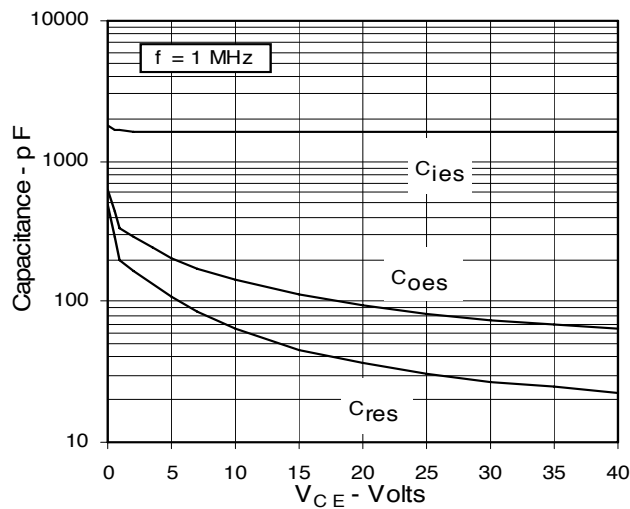

Fig. 16. Reverse-Bias Safe Operating Area

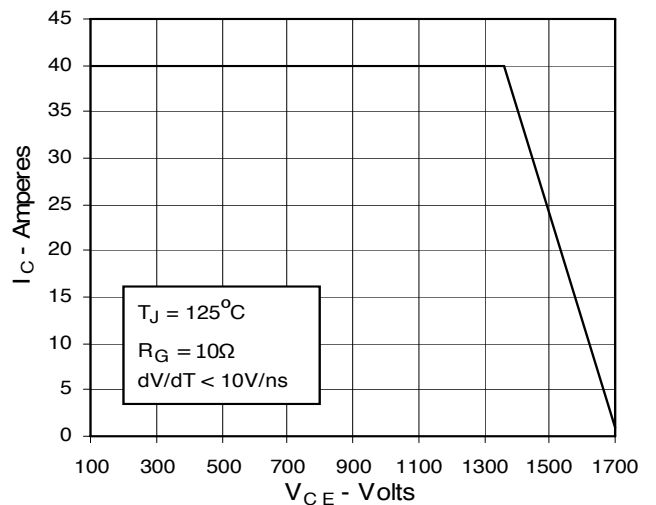
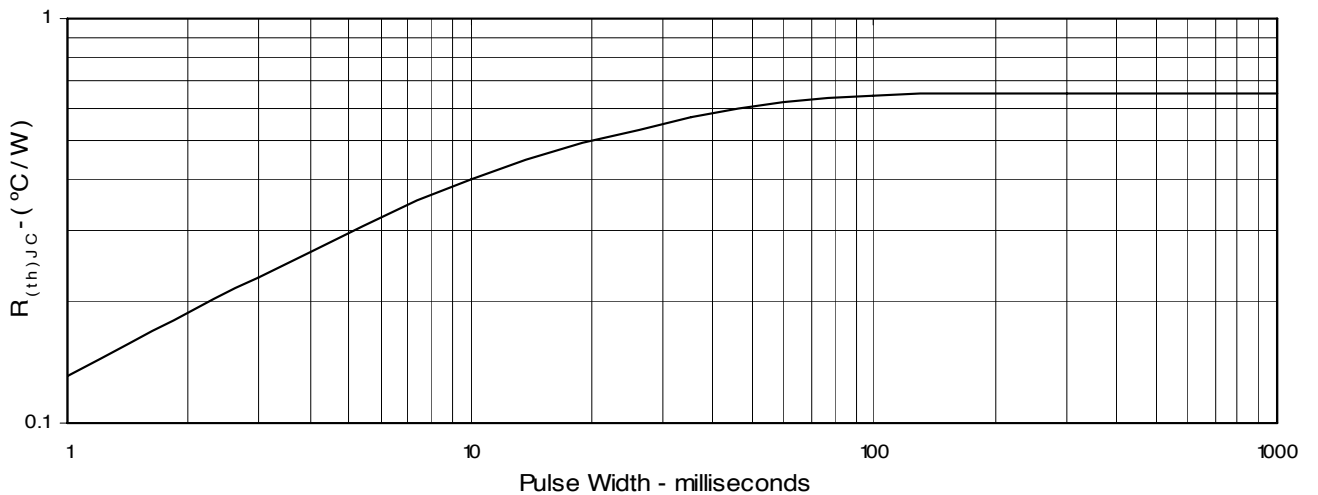

Fig. 17. Maximum Transient Thermal Resistance



PRELIMINARY TECHNICAL INFORMATION

The product presented herein is under development. The Technical Specifications offered are derived from data gathered during objective characterizations of preliminary engineering lots; but also may yet contain some information supplied during a subjective pre-production design evaluation. IXYS reserves the right to change limits, test conditions, and dimensions without notice.



Стандарт Электрон Связь

Мы молодая и активно развивающаяся компания в области поставок электронных компонентов. Мы поставляем электронные компоненты отечественного и импортного производства напрямую от производителей и с крупнейших складов мира.

Благодаря сотрудничеству с мировыми поставщиками мы осуществляем комплексные и плановые поставки широчайшего спектра электронных компонентов.

Собственная эффективная логистика и склад в обеспечивает надежную поставку продукции в точно указанные сроки по всей России.

Мы осуществляем техническую поддержку нашим клиентам и предпродажную проверку качества продукции. На все поставляемые продукты мы предоставляем гарантию .

Осуществляем поставки продукции под контролем ВП МО РФ на предприятия военно-промышленного комплекса России , а также работаем в рамках 275 ФЗ с открытием отдельных счетов в уполномоченном банке. Система менеджмента качества компании соответствует требованиям ГОСТ ISO 9001.

Минимальные сроки поставки, гибкие цены, неограниченный ассортимент и индивидуальный подход к клиентам являются основой для выстраивания долгосрочного и эффективного сотрудничества с предприятиями радиоэлектронной промышленности, предприятиями ВПК и научно-исследовательскими институтами России.

С нами вы становитесь еще успешнее!

Наши контакты:

Телефон: +7 812 627 14 35

Электронная почта: sales@st-electron.ru

Адрес: 198099, Санкт-Петербург,
Промышленная ул, дом № 19, литера Н,
помещение 100-Н Офис 331