

IRG4PC50UPbF

INSULATED GATE BIPOLAR TRANSISTOR

UltraFast Speed IGBT

Features

- UltraFast: Optimized for high operating frequencies 8-40 kHz in hard switching, >200 kHz in resonant mode
- Generation 4 IGBT design provides tighter parameter distribution and higher efficiency than Generation 3
- Industry standard TO-247AC package
- Lead-Free

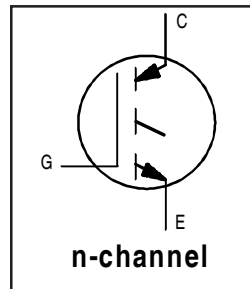

| |
|-----------------------------|
| $V_{CES} = 600V$ |
| $V_{CE(on) typ.} = 1.65V$ |
| @ $V_{GE} = 15V, I_C = 27A$ |

Benefits

- Generation 4 IGBT's offer highest efficiency available
- IGBT's optimized for specified application conditions
- Designed to be a "drop-in" replacement for equivalent industry-standard Generation 3 IR IGBT's

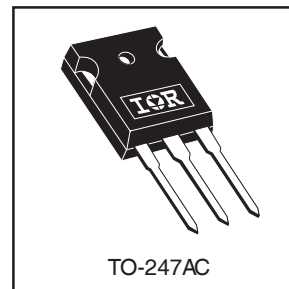

Absolute Maximum Ratings

| | Parameter | Max. | Units |
|---------------------------|--|--------------------|-------|
| V_{CES} | Collector-to-Emitter Breakdown Voltage | 600 | V |
| $I_C @ T_C = 25^\circ C$ | Continuous Collector Current | 55 | A |
| $I_C @ T_C = 100^\circ C$ | Continuous Collector Current | 27 | |
| I_{CM} | Pulsed Collector Current ① | 220 | |
| I_{LM} | Clamped Inductive Load Current ② | 220 | |
| V_{GE} | Gate-to-Emitter Voltage | ± 20 | V |
| E_{ARV} | Reverse Voltage Avalanche Energy ③ | 20 | mJ |
| $P_D @ T_C = 25^\circ C$ | Maximum Power Dissipation | 200 | W |
| $P_D @ T_C = 100^\circ C$ | Maximum Power Dissipation | 78 | |
| T_J | Operating Junction and Storage Temperature Range | -55 to + 150 | °C |
| T_{STG} | | | |
| | | | |
| | Mounting torque, 6-32 or M3 screw. | 10 lbf•in (1.1N•m) | |

Thermal Resistance

| | Parameter | Typ. | Max. | Units |
|-----------------|---|----------|------|-------|
| $R_{\theta JC}$ | Junction-to-Case | ---- | 0.64 | °C/W |
| $R_{\theta CS}$ | Case-to-Sink, Flat, Greased Surface | 0.24 | ---- | |
| $R_{\theta JA}$ | Junction-to-Ambient, typical socket mount | ---- | 40 | |
| Wt | Weight | 6 (0.21) | ---- | |

Electrical Characteristics @ $T_J = 25^\circ\text{C}$ (unless otherwise specified)

| | Parameter | Min. | Typ. | Max. | Units | Conditions |
|---------------------------------|--|------|------|-----------|---------|--|
| $V_{(BR)CES}$ | Collector-to-Emitter Breakdown Voltage | 600 | ---- | ---- | V | $V_{GE} = 0V, I_C = 250\mu A$ |
| $V_{(BR)ECS}$ | Emitter-to-Collector Breakdown Voltage ④ | 18 | ---- | ---- | V | $V_{GE} = 0V, I_C = 1.0A$ |
| $\Delta V_{(BR)CES}/\Delta T_J$ | Temperature Coeff. of Breakdown Voltage | ---- | 0.60 | ---- | V/°C | $V_{GE} = 0V, I_C = 1.0mA$ |
| $V_{CE(ON)}$ | Collector-to-Emitter Saturation Voltage | ---- | 1.65 | 2.0 | V | $I_C = 27A$ $I_C = 55A$ $I_C = 27A, T_J = 150^\circ\text{C}$ $V_{GE} = 15V$ See Fig.2, 5 |
| | | ---- | 2.0 | ---- | | |
| | | ---- | 1.6 | ---- | | |
| $V_{GE(th)}$ | Gate Threshold Voltage | 3.0 | ---- | 6.0 | | $V_{CE} = V_{GE}, I_C = 250\mu A$ |
| $\Delta V_{GE(th)}/\Delta T_J$ | Temperature Coeff. of Threshold Voltage | ---- | -13 | ---- | mV/°C | $V_{CE} = V_{GE}, I_C = 250\mu A$ |
| g_{fe} | Forward Transconductance ⑤ | 16 | 24 | ---- | S | $V_{CE} \geq 15V, I_C = 27A$ |
| I_{CES} | Zero Gate Voltage Collector Current | ---- | ---- | 250 | μA | $V_{GE} = 0V, V_{CE} = 600V$ |
| | | ---- | ---- | 2.0 | | $V_{GE} = 0V, V_{CE} = 10V, T_J = 25^\circ\text{C}$ |
| | | ---- | ---- | 5000 | | $V_{GE} = 0V, V_{CE} = 600V, T_J = 150^\circ\text{C}$ |
| I_{GES} | Gate-to-Emitter Leakage Current | ---- | ---- | ± 100 | nA | $V_{GE} = \pm 20V$ |

Switching Characteristics @ $T_J = 25^\circ\text{C}$ (unless otherwise specified)

| | Parameter | Min. | Typ. | Max. | Units | Conditions |
|--------------|-----------------------------------|------|------|------|-------|--|
| Q_g | Total Gate Charge (turn-on) | ---- | 180 | 270 | nC | $I_C = 27A$ $V_{CC} = 400V$ $V_{GE} = 15V$ See Fig. 8 |
| Q_{ge} | Gate - Emitter Charge (turn-on) | ---- | 25 | 38 | | |
| Q_{gc} | Gate - Collector Charge (turn-on) | ---- | 61 | 90 | | |
| $t_{d(on)}$ | Turn-On Delay Time | ---- | 32 | ---- | ns | $T_J = 25^\circ\text{C}$ $I_C = 27A, V_{CC} = 480V$ $V_{GE} = 15V, R_G = 5.0\Omega$ Energy losses include "tail" See Fig. 10, 11, 13, 14 |
| t_r | Rise Time | ---- | 20 | ---- | | |
| $t_{d(off)}$ | Turn-Off Delay Time | ---- | 170 | 260 | | |
| t_f | Fall Time | ---- | 88 | 130 | | |
| E_{on} | Turn-On Switching Loss | ---- | 0.12 | ---- | mJ | See Fig. 10, 11, 13, 14 |
| E_{off} | Turn-Off Switching Loss | ---- | 0.54 | ---- | | |
| E_{ts} | Total Switching Loss | ---- | 0.66 | 0.9 | | |
| $t_{d(on)}$ | Turn-On Delay Time | ---- | 31 | ---- | ns | $T_J = 150^\circ\text{C},$ $I_C = 27A, V_{CC} = 480V$ $V_{GE} = 15V, R_G = 5.0\Omega$ Energy losses include "tail" See Fig. 13, 14 |
| t_r | Rise Time | ---- | 23 | ---- | | |
| $t_{d(off)}$ | Turn-Off Delay Time | ---- | 230 | ---- | | |
| t_f | Fall Time | ---- | 120 | ---- | | |
| E_{ts} | Total Switching Loss | ---- | 1.6 | ---- | mJ | See Fig. 13, 14 |
| L_E | Internal Emitter Inductance | ---- | 13 | ---- | nH | Measured 5mm from package |
| C_{ies} | Input Capacitance | ---- | 4000 | ---- | pF | $V_{GE} = 0V$ $V_{CC} = 30V$ $f = 1.0MHz$ See Fig. 7 |
| C_{oes} | Output Capacitance | ---- | 250 | ---- | | |
| C_{res} | Reverse Transfer Capacitance | ---- | 52 | ---- | | |

Notes:

- ① Repetitive rating; $V_{GE} = 20V$, pulse width limited by max. junction temperature. (See fig. 13b)
- ② $V_{CC} = 80\%(V_{CES}), V_{GE} = 20V, L = 10\mu H, R_G = 5.0\Omega,$
(See fig. 13a)
- ③ Repetitive rating; pulse width limited by maximum junction temperature.
- ④ Pulse width $\leq 80\mu s$; duty factor $\leq 0.1\%$.
- ⑤ Pulse width $5.0\mu s$, single shot.

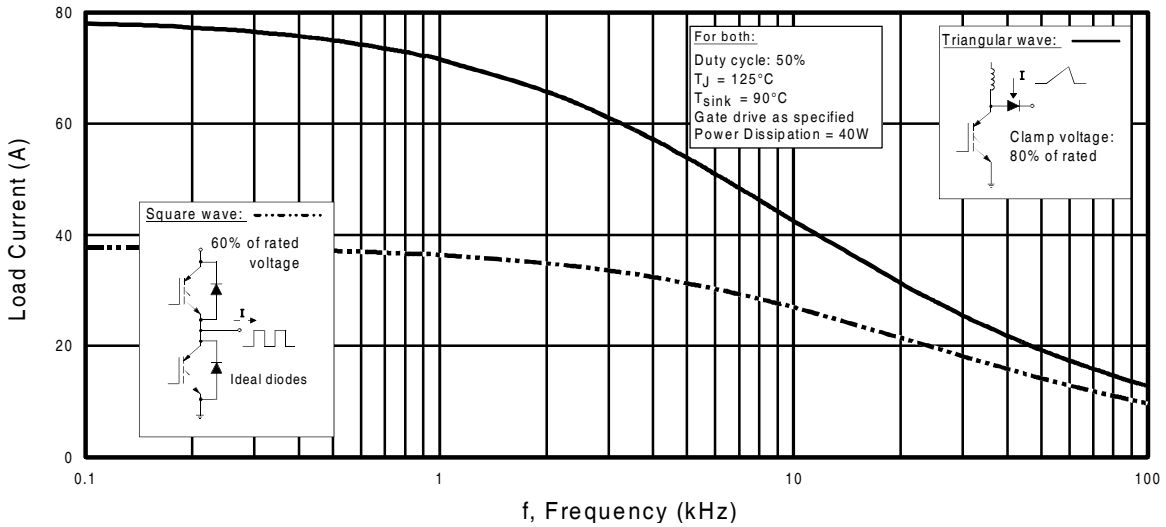

Fig. 1 - Typical Load Current vs. Frequency
(For square wave, $I = I_{RMS}$ of fundamental; for triangular wave, $I = I_{PK}$)

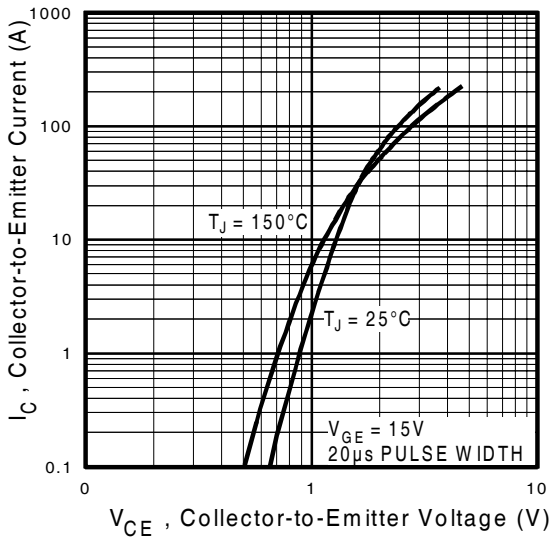

Fig. 2 - Typical Output Characteristics

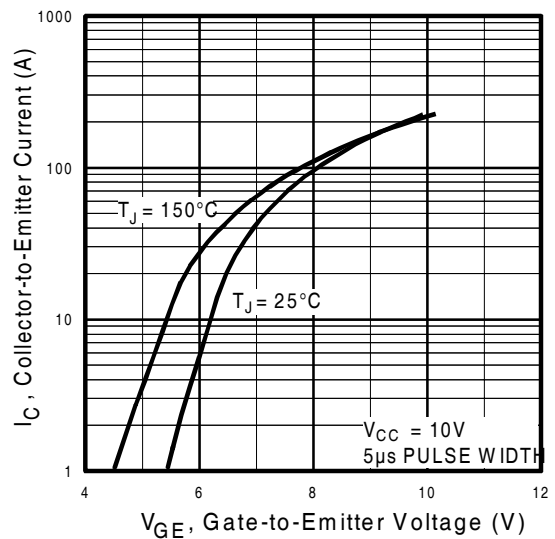

Fig. 3 - Typical Transfer Characteristics

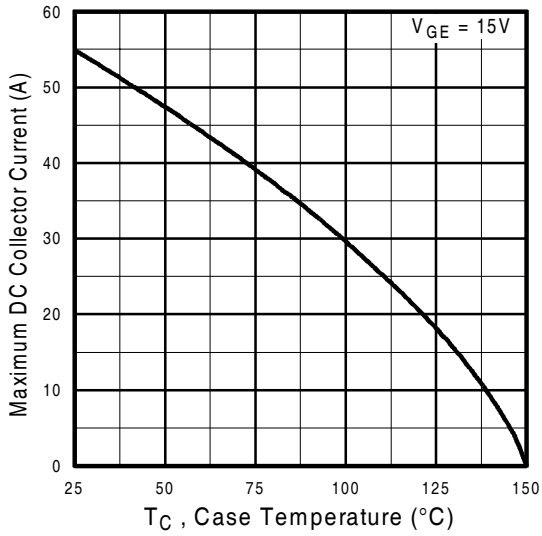

Fig. 4 - Maximum Collector Current vs. Case Temperature

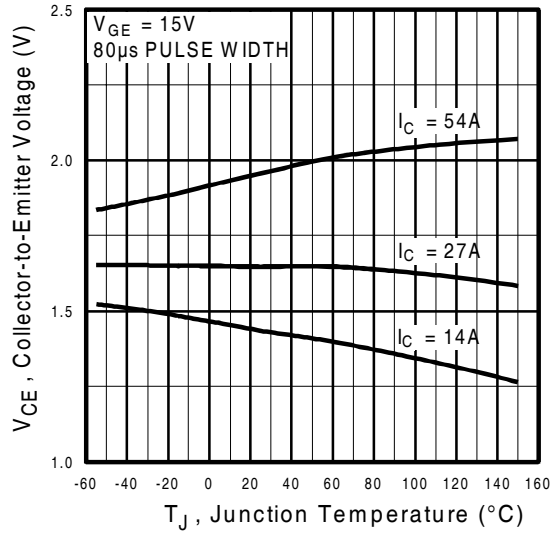

Fig. 5 - Collector-to-Emitter Voltage vs. Junction Temperature

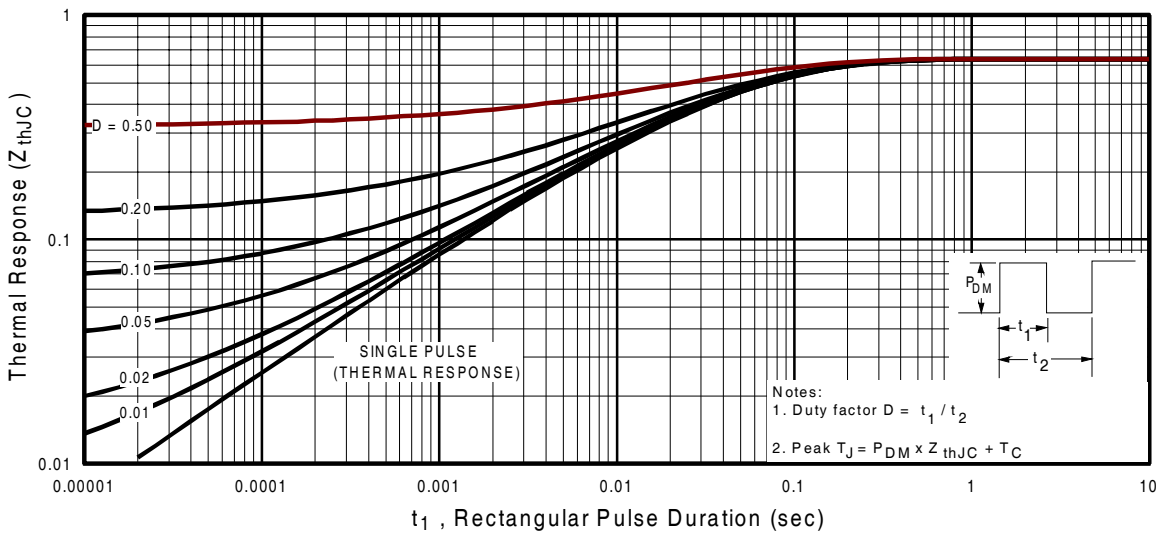

Fig. 6 - Maximum Effective Transient Thermal Impedance, Junction-to-Case

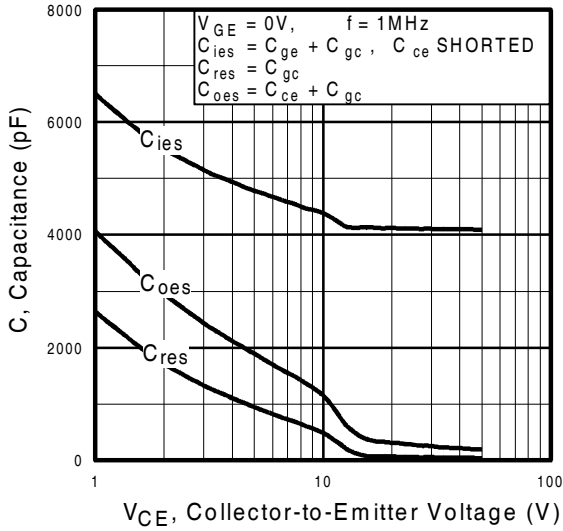

Fig. 7 - Typical Capacitance vs. Collector-to-Emitter Voltage

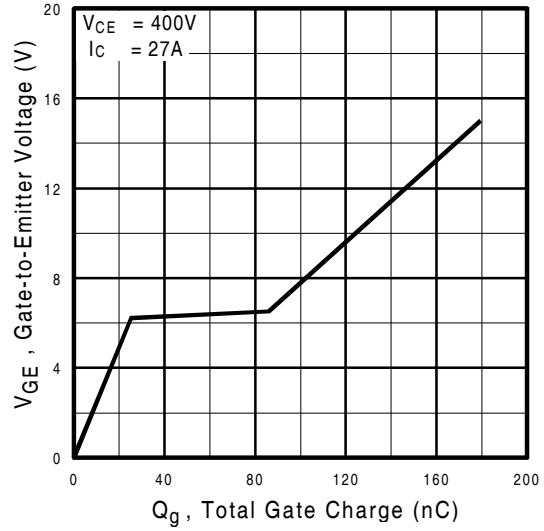

Fig. 8 - Typical Gate Charge vs. Gate-to-Emitter Voltage

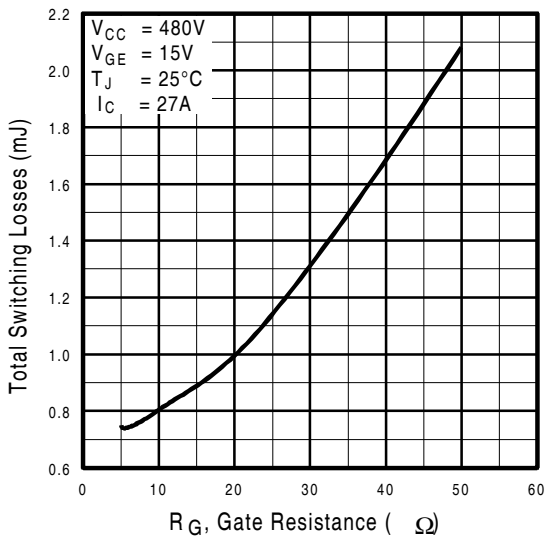

Fig. 9 - Typical Switching Losses vs. Gate Resistance

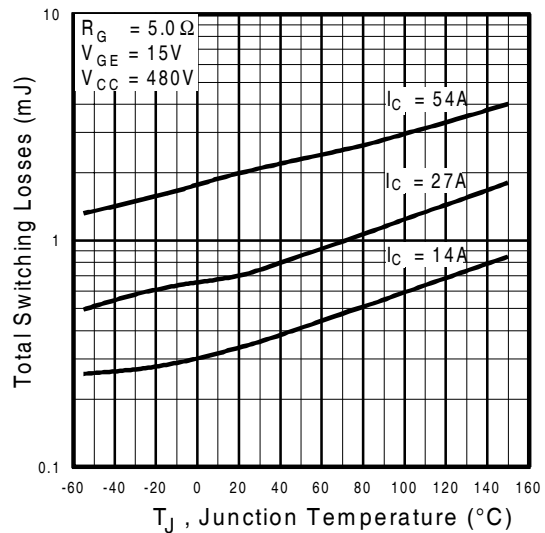

Fig. 10 - Typical Switching Losses vs. Junction Temperature

IRG4PC50UPbF

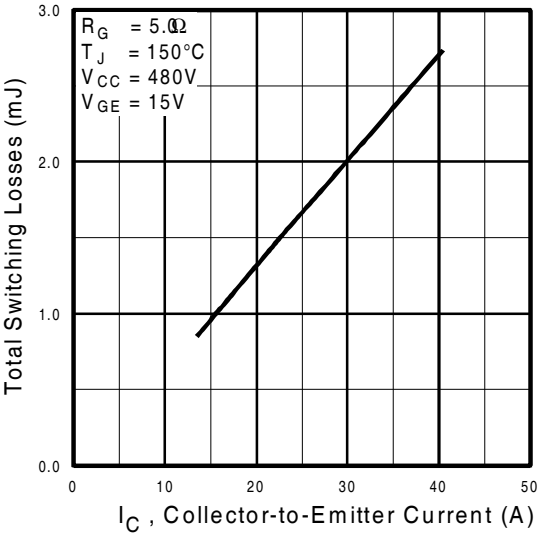

Fig. 11 - Typical Switching Losses vs. Collector-to-Emitter Current

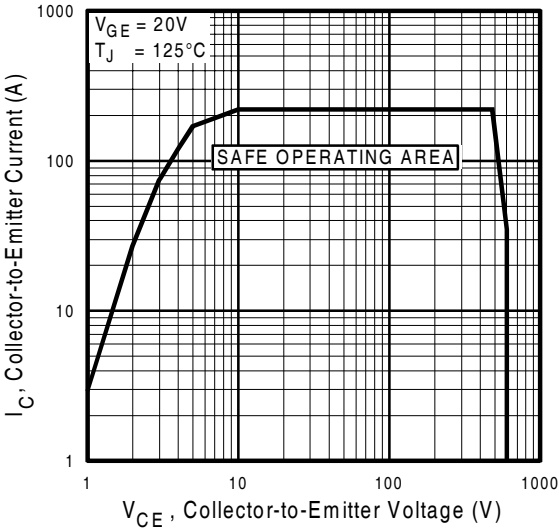
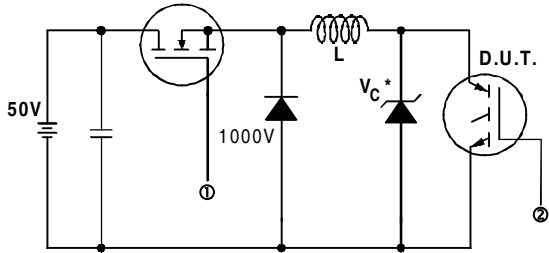

Fig. 12 - Turn-Off SOA



* Driver same type as D.U.T.; $V_c = 80\%$ of $V_{ce(max)}$
 * Note: Due to the 50V power supply, pulse width and inductor will increase to obtain rated I_d .

Fig. 13a - Clamped Inductive Load Test Circuit

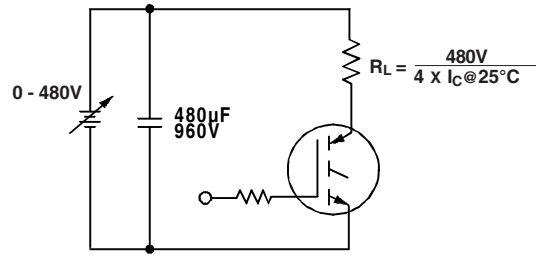

Fig. 13b - Pulsed Collector Current Test Circuit

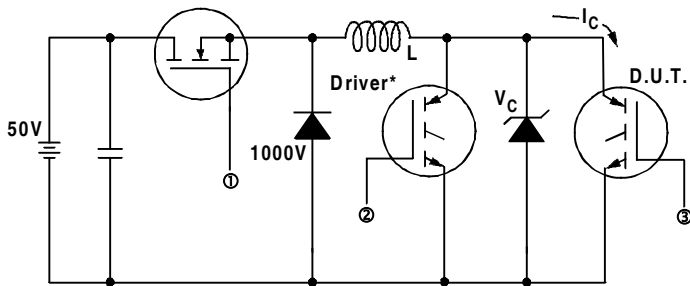

Fig. 14a - Switching Loss Test Circuit

* Driver same type as D.U.T., $V_C = 480V$

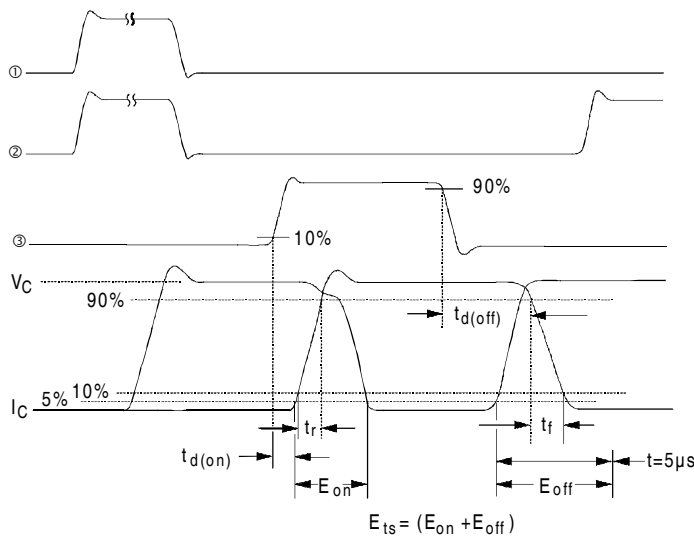

Fig. 14b - Switching Loss Waveforms

IRG4PC50UPbF

International
IR Rectifier

TO-247AC Package Outline

Dimensions are shown in millimeters (inches)

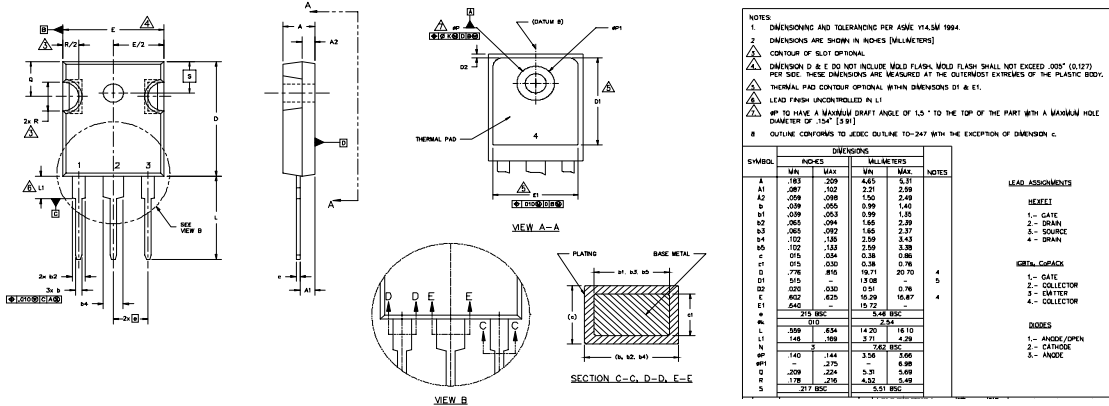

TO-247AC Part Marking Information

EXAMPLE: THIS IS AN IRFP30
WITH ASSEMBLY
LOT CODE 5657
ASSEMBLED ON WW 35, 2000
IN THE ASSEMBLY LINE "H"

Note: "P" in assembly line
position indicates "Lead-Free"

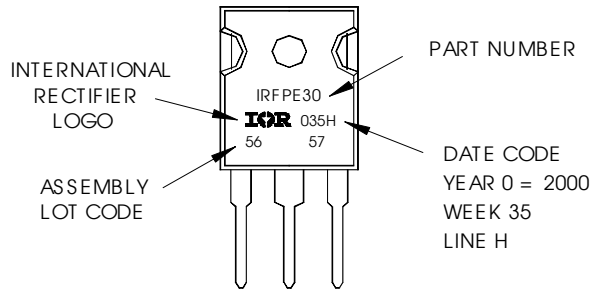

International
IR Rectifier

IR WORLD HEADQUARTERS: 233 Kansas St., El Segundo, California 90245, USA Tel: (310) 252-7105
TAC Fax: (310) 252-7903

Visit us at www.irf.com for sales contact information.
Data and specifications subject to change without notice. 04/04

Note: For the most current drawings please refer to the IR website at:
<http://www.irf.com/package/>



Стандарт Электрон Связь

Мы молодая и активно развивающаяся компания в области поставок электронных компонентов. Мы поставляем электронные компоненты отечественного и импортного производства напрямую от производителей и с крупнейших складов мира.

Благодаря сотрудничеству с мировыми поставщиками мы осуществляем комплексные и плановые поставки широчайшего спектра электронных компонентов.

Собственная эффективная логистика и склад в обеспечивает надежную поставку продукции в точно указанные сроки по всей России.

Мы осуществляем техническую поддержку нашим клиентам и предпродажную проверку качества продукции. На все поставляемые продукты мы предоставляем гарантию .

Осуществляем поставки продукции под контролем ВП МО РФ на предприятия военно-промышленного комплекса России , а также работаем в рамках 275 ФЗ с открытием отдельных счетов в уполномоченном банке. Система менеджмента качества компании соответствует требованиям ГОСТ ISO 9001.

Минимальные сроки поставки, гибкие цены, неограниченный ассортимент и индивидуальный подход к клиентам являются основой для выстраивания долгосрочного и эффективного сотрудничества с предприятиями радиоэлектронной промышленности, предприятиями ВПК и научно-исследовательскими институтами России.

С нами вы становитесь еще успешнее!

Наши контакты:

Телефон: +7 812 627 14 35

Электронная почта: sales@st-electron.ru

Адрес: 198099, Санкт-Петербург,
Промышленная ул, дом № 19, литера Н,
помещение 100-Н Офис 331