

KEMET CONDUCTIVE POLYMER CHIP CAPACITORS

CHARGED™

T520 Series - KO Cap

FEATURES

- Polymer Cathode Technology
- Low ESR
- High Frequency Cap Retention
- No-Ignition Failure Mode
- Use Up to 90% of Rated Voltage (10% Derating) for part types ≤ 10 Volts
- Halogen Free Epoxy
- 100% Accelerated Steady State Aging
- Volumetrically Efficient
- Use Up to 80% of Rated Voltage (20% Derating) for part types > 10 Volts
- Capacitance 15 to 1000 μ F ($\pm 20\%$)
- Voltage 2V to 25V
- EIA Standard Case Sizes
- 100% Surge Current Tested
- Operating Temperature -55°C to $+105^{\circ}\text{C}$
- Self Healing Mechanism
- RoHS Compliant & Leadfree Terminations (see www.kemet.com for lead transition)

OUTLINE DRAWING

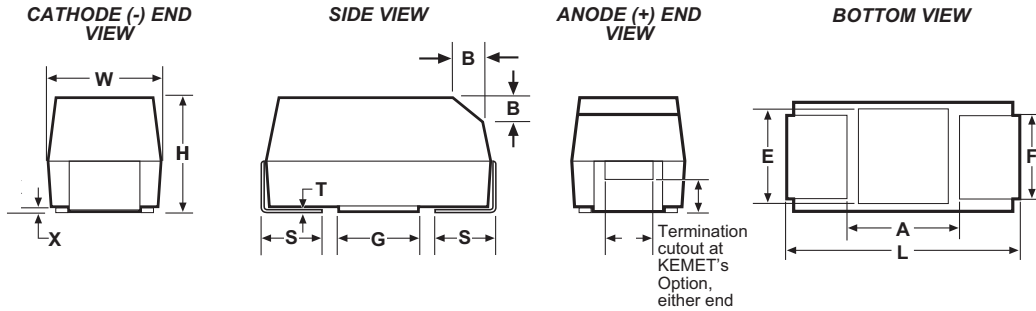

DIMENSIONS - MILLIMETERS

Case Size		L	W	H	F ± 0.1	S ± 0.3	X(Ref)	T(Ref)	A(Min)	G(ref)	E(ref)
KEMET	EIA										
A	3216-18	3.2 ± 0.2	1.6 ± 0.2	1.6 ± 0.2	1.2	0.8	0.10 ± 0.10	0.13	0.8	1.1	1.3
T	3528-12	3.5 ± 0.2	2.8 ± 0.2	1.2 max	2.2	0.8	0.05	0.13	1.1	1.8	2.2
M	3528-15	3.5 ± 0.2	2.8 ± 0.2	1.5 max	2.2	0.8	0.11	0.13	2.1	1.8	2.2
B	3528-21	3.5 ± 0.2	2.8 ± 0.2	1.9 ± 0.1	2.2	0.8	0.10 ± 0.10	0.13	1.1	1.8	2.2
U	6032-15	6.0 ± 0.3	3.2 ± 0.3	1.5 max	2.2	1.3	0.05	0.13	3.1	2.8	2.4
L	6032-19	6.0 ± 0.3	3.2 ± 0.3	1.9 max	2.2	1.3	0.10 ± 0.10	0.13	2.5	2.8	2.4
C	6032-28	6.0 ± 0.3	3.2 ± 0.3	2.5 ± 0.3	2.2	1.3	0.10 ± 0.10	0.13	2.5	2.8	2.4
W	7343-15	7.3 ± 0.3	4.3 ± 0.3	1.5 max	2.4	1.3	0.05	0.13	3.8	3.5	3.5
V	7343-20	7.3 ± 0.3	4.3 ± 0.3	1.9 max	2.4	1.3	0.05	0.13	3.8	3.5	3.5
D	7343-31	7.3 ± 0.3	4.3 ± 0.3	2.8 ± 0.3	2.4	1.3	0.10 ± 0.10	0.13	3.8	3.5	3.5
Y	7343-40	7.3 ± 0.3	4.3 ± 0.3	4.0 max	2.4	1.3	0.10 ± 0.10	0.13	3.8	3.5	3.5
X	7343-43	7.3 ± 0.3	4.3 ± 0.3	4.0 ± 0.3	2.4	1.3	0.10 ± 0.10	0.13	3.8	3.5	3.5

T520 ORDERING INFORMATION

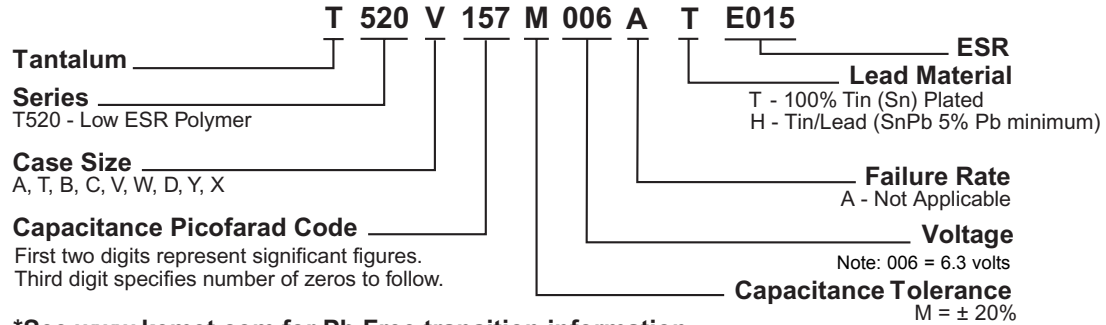

COMPONENT MARKING

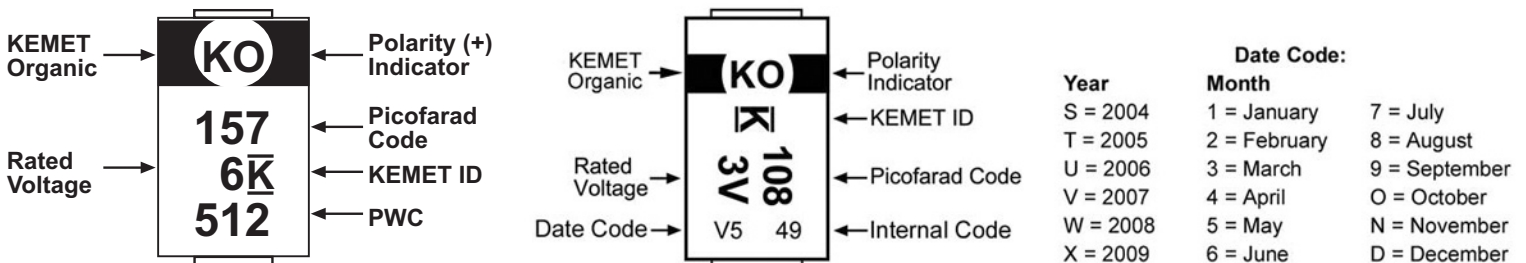

512 = 12th week of 2005

CONDUCTIVE POLYMER CHIP CAPACITORS

T520 Series - KO Cap



T520 RATINGS & PART NUMBER REFERENCE

Rated Voltage (V)	Rated Capacitance (µF)	Case Code/ Case Size	KEMET Part Number	DC Leakage µA @ 20°C max/ 5min	DF% @ 20°C 120 Hz Max	ESR mΩ @ 20°C 100 kHz Max	Maximum allowable ripple current (mA Arms) 100kHz*	MSL Reflow Temp ≤ 260°C
8	33	T/3528-12	T520T336M008A(1)E070	26	8	70	1200	3
	33	T/3528-12	T520T336M008A(1)E080	26	8	80	1100	
	33	B/3528-20	T520B336M008A(1)E025	26	8	25	2300	
	33	B/3528-20	T520B336M008A(1)E035	26	15	35	1900	
	33	B/3528-20	T520B336M008A(1)E040	26	8	40	1800	
	33	B/3528-20	T520B336M008A(1)E070	26	8	70	1300	
	33	U/6032-15	T520U336M008A(1)E070	26	8	70	1400	
	47	B/3528-20	T520B476M008A(1)E035	38	8	35	1900	
	47	B/3528-20	T520B476M008A(1)E070	38	8	70	1300	
	82	C/6032-28	T520C826M008A(1)E025	82	8	66	1600	
	82	C/6032-28	T520C826M008A(1)E045	82	8	66	1600	
	150	D/7343-31	T520D157M008A(1)E025	120	10	25	3000	
	150	D/7343-31	T520D157M008A(1)E040	120	10	40	2400	
	150	D/7343-31	T520D157M008A(1)E055	120	10	55	2000	
	150	V/7343-19	T520V157M008A(1)E040	120	10	40	2200	
10	10	A/3216-18	T520A106M010A(1)E080	10	8	80	1200	3
	15	A/3216-18	T520A156M010A(1)E080	15	8	80	1200	
	22	A/3216-18	T520A226M010A(1)E080	22	8	80	1200	
	33	T/3528-12	T520T336M010A(1)E040	33	8	40	1600	
	33	T/3528-12	T520T336M010A(1)E070	33	8	70	1200	
	33	T/3528-12	T520T336M010A(1)E080	33	8	80	1100	
	33	B/3528-20	T520B336M010A(1)E025	33	10	25	2300	
	33	B/3528-20	T520B336M010A(1)E035	33	8	35	1900	
	33	B/3528-20	T520B336M010A(1)E040	33	8	40	1800	
	33	B/3528-20	T520B336M010A(1)E070	33	8	70	1300	
	33	U/6032-15	T520U336M010A(1)E070	33	8	70	1400	
	47	B/3528-20	T520B476M010A(1)E035	47	8	35	1900	
	47	B/3528-20	T520B476M010A(1)E070	47	8	70	1300	
	47	U/6032-15	T520U476M010A(1)E055	47	8	55	1600	
	47	C/6032-28	T520C476M010A(1)E100	47	8	100	1300	
	68	U/6032-15	T520U686M010A(1)E055	68	8	55	1600	
	68	W/7343-15	T520W686M010A(1)E025	68	10	25	2200	
	68	W/7343-15	T520W686M010A(1)E040	68	10	40	1700	
	68	C/6032-28	T520C686M010A(1)E045	68	8	45	1900	
	68	V/7343-19	T520V686M010A(1)E025	68	10	25	2700	
	68	V/7343-19	T520V686M010A(1)E040	68	10	40	2200	
	68	V/7343-19	T520V686M010A(1)E045	68	10	45	2000	
	68	V/7343-19	T520V686M010A(1)E060	68	10	60	1800	
	68	V/7343-19	T520V686M010A(1)E100	68	10	100	1400	
	68	D/7343-31	T520D686M010A(1)E100	68	10	100	1500	
	100	C/6032-28	T520C107M010A(1)E025	100	8	25	2600	
	100	C/6032-28	T520C107M010A(1)E045	100	8	45	1900	
	100	L/6032-20	T520L107M010A(1)E025	100	10	25	2400	
	100	W/7343-15	T520W107M010A(1)E040	100	10	40	1700	
	100	V/7343-19	T520V107M010A(1)E018	100	10	18	3200	
100	V/7343-19	T520V107M010A(1)E025	100	10	25	2700		
100	V/7343-19	T520V107M010A(1)E045	100	10	45	2000		
100	V/7343-19	T520V107M010A(1)E050	100	10	50	1900		
100	D/7343-31	T520D107M010A(1)E018	100	10	18	3500		
100	D/7343-31	T520D107M010A(1)E055	100	10	55	2000		
100	D/7343-31	T520D107M010A(1)E080	100	10	80	1700		
150	C/6032-28	T520C157M010A(1)E055	150	8	55	1700		
150	V/7343-19	T520V157M010A(1)E018	150	10	18	3200		
150	V/7343-19	T520V157M010A(1)E025	150	10	25	2700		
150	V/7343-19	T520V157M010A(1)E040	150	10	40	2200		
150	D/7343-31	T520D157M010A(1)E015	150	10	15	3900		
150	D/7343-31	T520D157M010A(1)E018	150	10	18	3500		
150	D/7343-31	T520D157M010A(1)E025	150	10	25	3000		
150	D/7343-31	T520D157M010A(1)E040	150	10	40	2400		
150	D/7343-31	T520D157M010A(1)E055	150	10	55	2000		
150	Y/7343-40	T520Y157M010A(1)E015	150	10	15	4000		
150	Y/7343-40	T520Y157M010A(1)E018	150	10	18	3700		
150	Y/7343-40	T520Y157M010A(1)E025	150	10	25	3100		
220	V/7343-19	T520V227M010A(1)E045	220	10	45	2000		
220	Y/7343-40	T520Y227M010A(1)E040	220	10	40	2500		
220	D/7343-31	T520D227M010A(1)E018	220	10	18	3500		
220	D/7343-31	T520D227M010A(1)E025	220	10	25	3000		
220	D/7343-31	T520D227M010A(1)E040	220	10	40	2400		
330	Y/7343-40	T520Y337M010A(1)E015	330	10	15	4000		
330	Y/7343-40	T520Y337M010A(1)E035	330	10	35	2600		
330	X/7343-43	T520X337M010A(1)E010	330	10	10	5000		
330	X/7343-43	T520X337M010A(1)E025	330	10	25	3100		
330	X/7343-43	T520X337M010A(1)E040	330	10	40	2500		

*100kHz to 500kHz, 45° C

(1) To complete KEMET part number, insert letter designation for lead material from page 50. Higher voltage ratings and tighter tolerance product may be substituted with the same size at KEMET's option. Voltage substitutions will be marked with the higher voltage rating.

Rated Voltage (V)	Rated Capacitance (µF)	Case Code/ Case Size	KEMET Part Number	DC Leakage µA @ 20°C max/ 5min	DF% @ 20°C 120 Hz Max	ESR mΩ @ 20°C 100 kHz Max	Maximum allowable ripple current (mA Arms) 100kHz*	MSL Reflow Temp ≤ 260°C
12.5	10	T/3528-12	T520T106M12RA(1)E150	13	8	150	800	3
	15	T/3528-12	T520T156M12RA(1)E080	19	8	80	1100	
16	10	B/3528-20	T520B106M016A(1)E100	16	8	100	1100	3
	22	C/6032-28	T520C226M016A(1)E080	35	8	80	1400	
	33	W/7343-15	T520W336M016A(1)E045	53	10	60	1400	
	33	V/7343-19	T520V336M016A(1)E045	53	10	45	2000	
	33	V/7343-19	T520V336M016A(1)E060	53	10	60	1800	
	33	V/7343-19	T520V336M016A(1)E070	53	10	70	1600	
	47	W/7343-15	T520W476M016A(1)E045	75	10	45	1600	
	47	V/7343-19	T520V476M016A(1)E045	75	10	45	2000	
	47	V/7343-19	T520V476M016A(1)E070	76	10	70	1600	
	47	D/7343-31	T520D476M016A(1)E035	75	10	35	2500	
16	47	D/7343-31	T520D476M016A(1)E070	75	10	70	1800	3
	68	D/7343-31	T520D686M016A(1)E050	109	10	50	2100	
	150	X/7343-43	T520X157M016A(1)E040	240	10	40	2500	
	22	V/7343-19	T520V226M020A(1)E040	44	10	40	2200	
	22	V/7343-19	T520V226M020A(1)E045	44	10	45	2000	
20	22	V/7343-19	T520V226M020A(1)E090	44	10	90	1400	3
	15	V/7343-19	T520V156M025A(1)E090	38	10	90	1400	
25	15	D/7343-31	T520D156M025A(1)E060	38	10	60	1900	3
	15	D/7343-31	T520D156M025A(1)E080	38	10	80	1700	

*100kHz to 500kHz, 45° C

(1) To complete KEMET part number, insert letter designation for lead material from page 50. Higher voltage ratings and tighter tolerance product may be substituted with the same size at KEMET's option. Voltage substitutions will be marked with the higher voltage rating.

Tape & Reel Packaging

KEMET's Molded Tantalum and Aluminum Chip Capacitor families are packaged in 8 mm and 12 mm plastic tape on 7" and 13" reels, in accordance with EIA Standard 481-1: Taping of Surface Mount Components for Automatic Handling. This packaging system is compatible with all tape fed automatic pick and place systems.

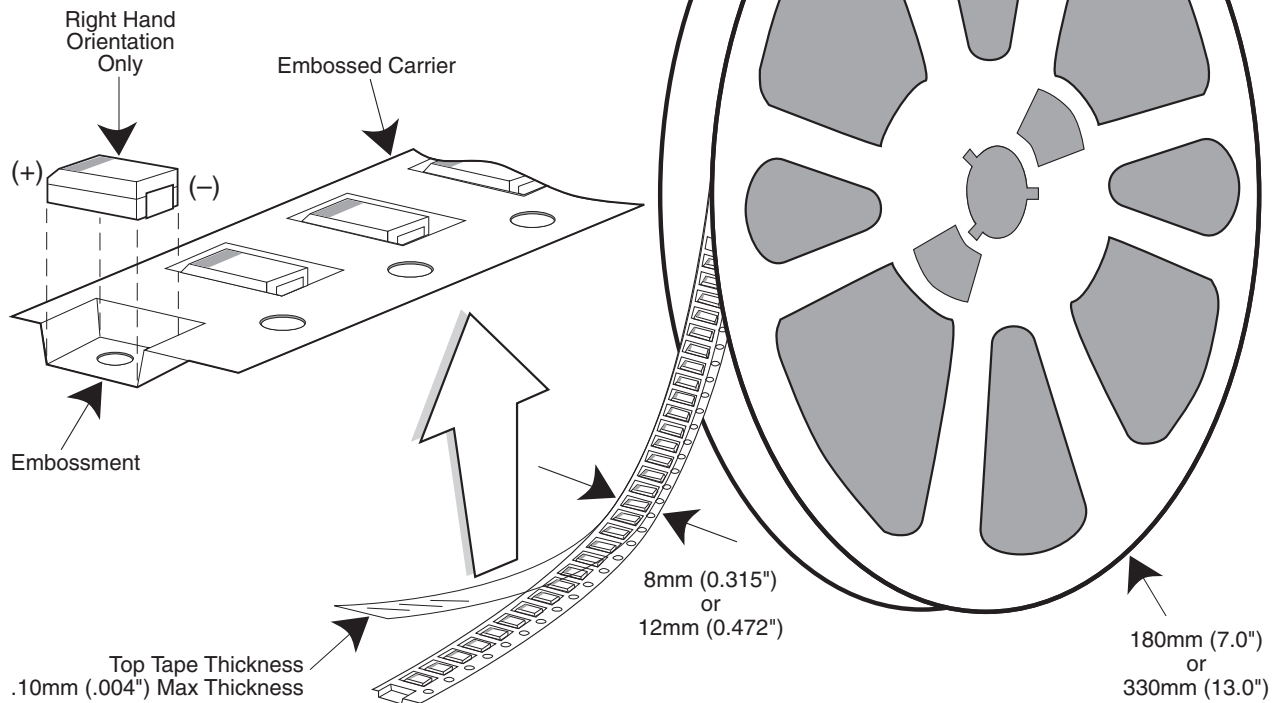

Labeling: Bar code labeling (standard or custom) shall be on the side of the reel opposite the sprocket holes. Refer to EIA-556.

QUANTITIES PACKAGED PER REEL

Case Code		Tape Width-mm	7" Reel*	13" Reel
KEMET	EIA			
R	2012 12	8	2,500	10,000
I	3216 10	8	3,000	12,000
S	3216 12	8	2,500	10,000
T	3528 12	8	2,500	10,000
M	3528 15	8	2,000	8,000
U	6032 15	12	1,000	5,000
L	6032 19	12	1,000	5,000
W	7343 15	12	1,000	3,000
Z	7343 17	12	1,000	3,000
V	7343 20	12	1,000	3,000
A	3216 18	8	2,000	9,000
B	3528 21	8	2,000	8,000
C	6032 28	12	500	3,000
D	7343 31	12	500	2,500
Y	7343 40	12	500	2,000
X	7343 43	12	500	2,000
E	7260 38	12	500	2,000

* No c-spec required for 7" reel packaging. C-7280 required for 13" reel packaging.

TANTALUM, CERAMIC AND ALUMINUM CHIP CAPACITORS

Packaging Information

Performance Notes

- Cover Tape Break Force:** 1.0 Kg Minimum.
- Cover Tape Peel Strength:** The total peel strength of the cover tape from the carrier tape shall be:

Tape Width	Peel Strength
8 mm	0.1 Newton to 1.0 Newton (10g to 100g)
12 mm	0.1 Newton to 1.3 Newton (10g to 130g)

The direction of the pull shall be opposite the direction of the carrier tape travel. The pull angle of the carrier tape shall be 165° to 180° from the plane of the carrier tape. During peeling, the carrier and/or cover tape shall be pulled at a velocity of 300 ±10 mm/minute.

- Reel Sizes:** Molded tantalum capacitors are available on either 180 mm (7") reels (standard) or 330 mm (13") reels (with C-7280). Note that 13" reels are preferred.
- Labeling:** Bar code labeling (standard or custom) shall be on the side of the reel opposite the sprocket holes. Refer to EIA-556.

Embossed Carrier Tape Configuration: Figure 1

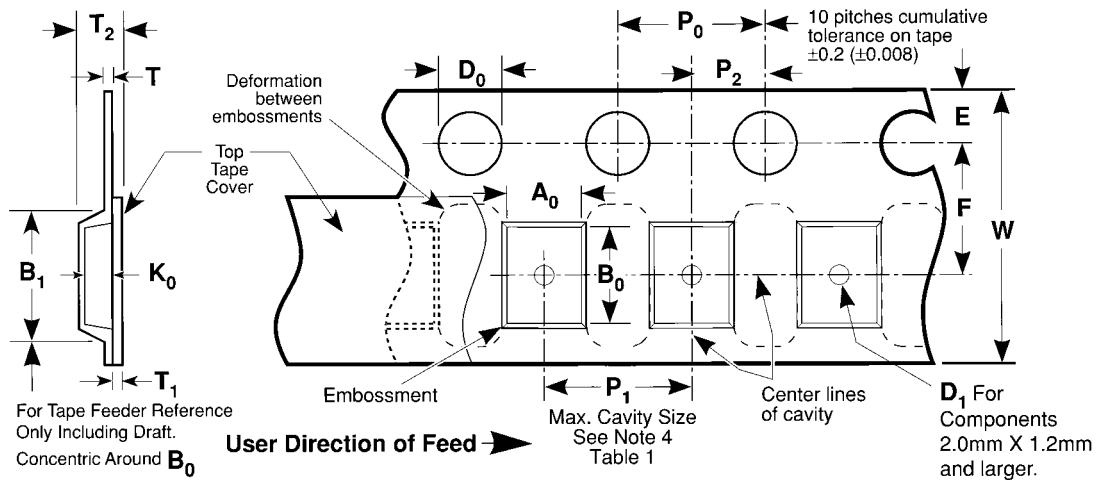

Table 1 — EMBOSSED TAPE DIMENSIONS (Metric will govern)

Constant Dimensions — Millimeters (Inches)									
Tape Size	D ₀	E	P ₀	P ₂	T Max	T ₁ Max			
8 mm and 12 mm	1.5 +0.10 -0.0 (0.059 +0.004, -0.0)	1.75 ±0.10 (0.069 ±0.004)	4.0 ±0.10 (0.157 ±0.004)	2.0 ±0.05 (0.079 ±0.002)	0.600 (0.024)	0.100 (0.004)			
Variable Dimensions — Millimeters (Inches)									
Tape Size	Pitch	B ₁ Max. Note 1	D ₁ Min. Note 2	F	P ₁	R Min. Note 3	T ₂ Max	W	A ₀ B ₀ K ₀ Note 4
8 mm	Single (4 mm)	4.4 (0.173)	1.0 (0.039)	3.5 ±0.05 (0.138 ±0.002)	4.0 ±0.10 (0.157 ±0.004)	25.0 (0.984)	2.5 (0.098)	8.0 ±0.30 (.315 ±0.012)	
12 mm	Double (8 mm)	8.2 (0.323)	1.5 (0.059)	5.5 ±0.05 (0.217 ±0.002)	8.0 ±0.10 (0.315 ±0.004)	30.0 (1.181)	4.6 (0.181)	12.0 ±0.30 (0.472 ±0.012)	

NOTES

- B₁ dimension is a reference dimension for tape feeder clearance only.
- The embossment hole location shall be measured from the sprocket hole controlling the location of the embossment. Dimensions of embossment location and hole location shall be applied independent of each other.
- Tape with components shall pass around radius "R" without damage (see sketch A). The minimum trailer length (Fig. 2) may require additional length to provide R min. for 12 mm embossed tape for reels with hub diameters approaching N min. (Table 2)
- The cavity defined by A₀, B₀, and K₀ shall be configured to surround the part with sufficient clearance such that the chip does not protrude beyond the sealing plane of the cover tape, the chip can be removed from the cavity in a vertical direction without mechanical restriction, rotation of the chip is limited to 20 degrees maximum in all 3 planes, and lateral movement of the chip is restricted to 0.5 mm maximum in the pocket (not applicable to vertical clearance.)

Packaging Information

Embossed Carrier Tape Configuration (cont.)

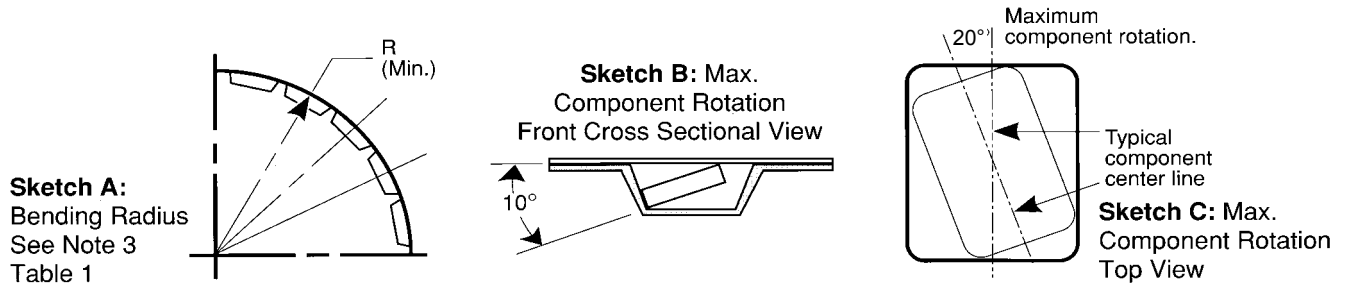

Sketch D: Tape Camber (Top View)

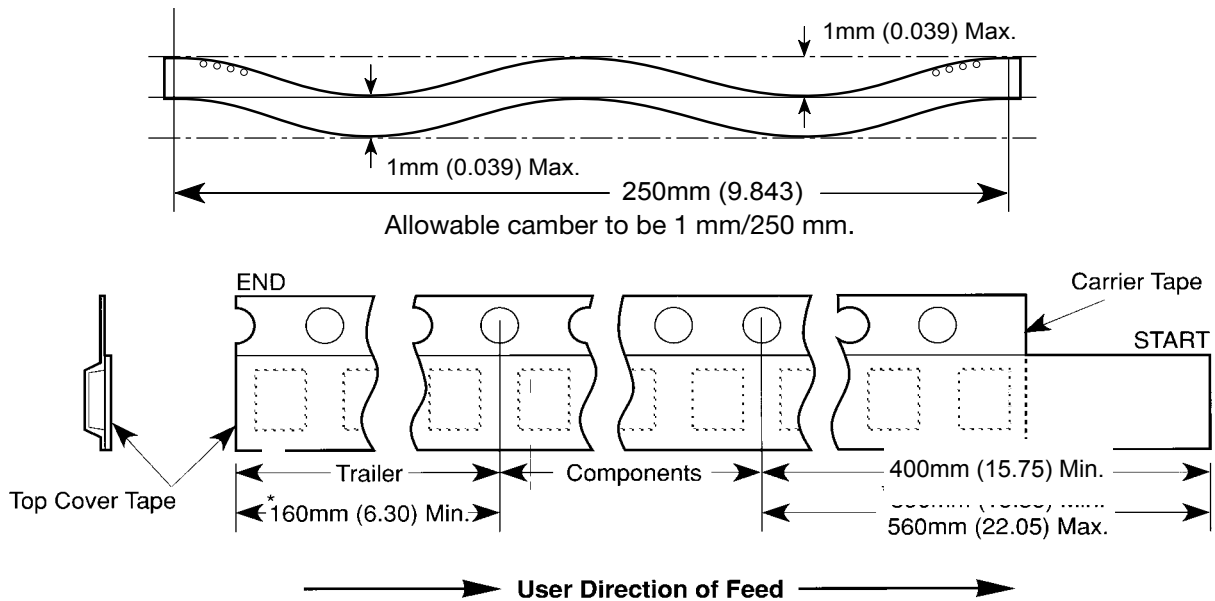

Figure 2: Tape Leader & Trailer Dimensions (Metric Dimensions Will Govern)

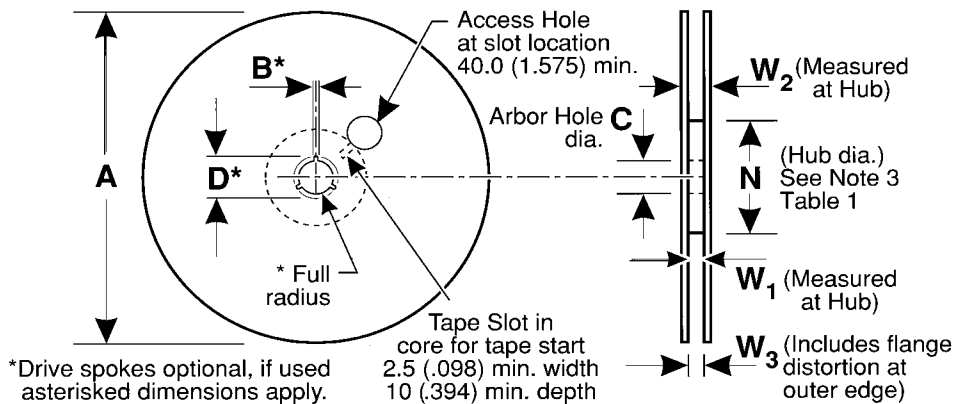

Figure 3: Reel Dimensions (Metric Dimensions will govern)

Table 2 – REEL DIMENSIONS (Metric will govern)

Tape Size	A Max	B* Min	C	D* Min	N Min	W ₁	W ₂ Max	W ₃
8 mm	330.0 (12.992)	1.5 (0.059)	13.0 ± 0.20 (0.512 ± 0.008)	20.2 (0.795)	50.0 (1.969) See Note 3	8.4 +1.5, -0.0 (0.331 +0.059, -0.0)	14.4 (0.567)	7.9 Min (0.311) 10.9 Max (0.429)
12 mm	330.0 (12.992)	1.5 (0.059)	13.0 ± 0.20 (0.512 ± 0.008)	20.2 (0.795)	Table 1	12.4 +2.0, -0.0 (0.488 +0.078, -0.0)	18.4 (0.724)	11.9 Min (0.469) 15.4 Max (0.606)

World Sales Headquarters

KEMET Electronics Corporation
P.O. Box 5928
Greenville, SC 29606
Phone: 864-963-6300

Europe

KEMET Electronics S.A.
15bis Chemin des Mines
1202 Geneva,
Switzerland
Phone: 41-22-715-0100

Asia

KEMET Electronics Marketing PTE Ltd.
73 Bukit Timah Road
#05-01 Rex House
Singapore, 229832, Singapore
Phone: 65-6386-1900

KEMET Electronics Asia Ltd.
30 Canton Road, Room 1512
SilverCord Tower II
Tsimshatshui, Kowloon
Hong Kong
Phone: 852-2305-1168



Стандарт Электрон Связь

Мы молодая и активно развивающаяся компания в области поставок электронных компонентов. Мы поставляем электронные компоненты отечественного и импортного производства напрямую от производителей и с крупнейших складов мира.

Благодаря сотрудничеству с мировыми поставщиками мы осуществляем комплексные и плановые поставки широчайшего спектра электронных компонентов.

Собственная эффективная логистика и склад в обеспечивает надежную поставку продукции в точно указанные сроки по всей России.

Мы осуществляем техническую поддержку нашим клиентам и предпродажную проверку качества продукции. На все поставляемые продукты мы предоставляем гарантию .

Осуществляем поставки продукции под контролем ВП МО РФ на предприятия военно-промышленного комплекса России , а также работаем в рамках 275 ФЗ с открытием отдельных счетов в уполномоченном банке. Система менеджмента качества компании соответствует требованиям ГОСТ ISO 9001.

Минимальные сроки поставки, гибкие цены, неограниченный ассортимент и индивидуальный подход к клиентам являются основой для выстраивания долгосрочного и эффективного сотрудничества с предприятиями радиоэлектронной промышленности, предприятиями ВПК и научно-исследовательскими институтами России.

С нами вы становитесь еще успешнее!

Наши контакты:

Телефон: +7 812 627 14 35

Электронная почта: sales@st-electron.ru

Адрес: 198099, Санкт-Петербург,
Промышленная ул, дом № 19, литера Н,
помещение 100-Н Офис 331