



Military COTS 270 Vin Filter

M-FIAM3

Model Number **M-FIAM3M21***

Input Attenuator Module

Features

- EMI filtering-MIL-STD-461E^[1]
- Transient protection-MIL-STD-704E/F
- Environments-MIL-STD-810, MIL-STD-202
- Environmental stress screening
- Low profile mounting options
- Output current up to 3 A
- Mini sized package
- Inrush current limiting

Product Highlights

The M-FIAM3 is a DC front-end module that provides EMI filtering and transient protection. The M-FIAM3 enables designers using Vicor's Maxi, Mini, Micro Series 300 V DC-DC converters to meet conducted emission/ conducted susceptibility per MIL-STD-461E; and input transients per MIL-STD-704E/F. The M-FIAM3 accepts an input voltage of 180 – 375 Vdc and delivers output current up to 3 A.

M-FIAM3 is housed in an industry standard "half brick" module measuring 2.28" x 2.2" x 0.5" and depending upon model selected, may be mounted on-board or in-board for height critical applications.

Compatible Products

- Maxi, Mini, Micro Series 300 V Input DC-DC converters

^[1]EMI performance is subject to a wide variety of external influences such as PCB construction, circuit layout etc. External components in addition to those listed herein may be required in specific instances to gain full compliance to the standards specified at various line and load conditions.



Actual size:
2.28 x 2.2 x 0.5 in
57,9 x 55,9 x 12,7 mm

Absolute Maximum Rating

Parameter	Rating	Unit	Notes
+In to -In	375	Vdc	Continuous
	400	Vdc	100 ms
Mounting torque	5 (0.57)	in-lbs	6 each, #4-40 or M3
Pin Soldering temperature	500 (260)	°F (°C)	<5 sec; wave solder
	750 (390)	°F (°C)	<7 sec; hand solder

Thermal Resistance and Capacity

Parameter	Min	Typ	Max	Unit
Baseplate to sink				
flat, greased surface		0.16		°C/Watt
with thermal pad (P/N 20264)		0.1		°C/Watt
Baseplate to ambient				
Free convection		7.9		°C/Watt
1000 LFM		2.2		°C/Watt

MTBF per MIL-HDBK-217F (M-FIAM3M21)

Temperature	Environment	MTBF	Unit
25°C	Ground Benign: G.B.	13,291	1,000 Hrs
50°C	Naval Sheltered: N.S.	2,392	1,000 Hrs
65°C	Airborne Inhabited Cargo: A.I.C.	1,874	1,000 Hrs

Part Numbering

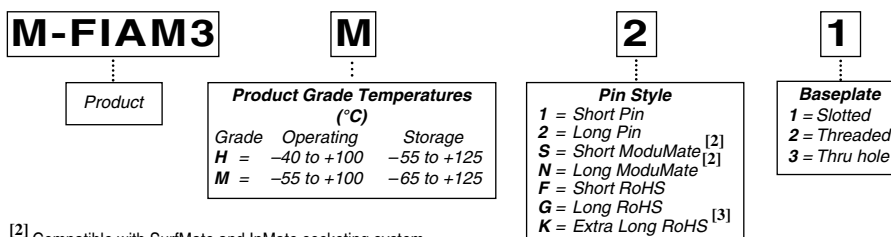

^[2] Compatible with SurfMate and InMate socketing system

^[3] Not intended for socket or Surfmate mounting

SPECIFICATIONS

(typical at $T_{BP} = 25^{\circ}\text{C}$, nominal line and 75% load, unless otherwise specified)

INPUT SPECIFICATIONS

Parameter	Min	Typ	Max	Unit	Notes
Input voltage	180	270	375	Vdc	Continuous
Inrush limiting			0.018	A/ μF	
Transient immunity					Exceeds limits of MIL-STD-704E/F

OUTPUT SPECIFICATIONS

Parameter	Min	Typ	Max	Unit	Notes
Output current			3	A	
Efficiency	96	98		%	
Internal voltage drop		3.0	5.0		@3 A, 100°C baseplate
External capacitance	10		22	μF	See Figure 5 on page 4. 400 V

CONTROL PIN SPECIFICATIONS

Parameter	Min	Typ	Max	Unit	Notes
ON/OFF control					
Enable (ON)	0.0		1.0	Vdc	Referenced to – Vout
Disable (OFF)	3.5		5.0	Vdc	100 k Ω internal pull-up resistor

SAFETY SPECIFICATIONS

Parameter	Min	Typ	Max	Unit	Notes
Dielectric withstand		1,500	Vrms		Input/Output to Base
		2,121	Vdc		Input/Output to Base

EMI

Standard	Test Procedure	Notes
MIL-STD-461E		
Conducted emissions:	CE101, CE102	
Conducted susceptibility:	CS101, CS114, CS115, CS116	

EMI performance is subject to a wide variety of external influences such as PCB construction, circuit layout etc. As such, external components in addition to those listed herein may be required in specific instances to gain full compliance to the standards specified.

SPECIFICATIONS (CONT.)

■ GENERAL SPECIFICATIONS

Parameter	Min	Typ	Max	Unit	Notes
Weight		3.3 (94)		Ounces (grams)	
Warranty			2	Years	

■ ENVIRONMENTAL QUALIFICATION

Altitude MIL-STD-810F, Method 500.4, Procedure I & II, 40,000 ft. and 70,000 ft. Operational.
Explosive Atmosphere MIL-STD-810F, Method 511.4, Procedure I, Operational.
Vibration MIL-STD-810F, Method 514.5, Procedure I, Category 14, Sine and Random vibration per Table 514.5C for Helicopter AH-6J Main Rotor with overall level of 5.6 G rms for 4 hours per axis. MIL-STD-810F, Method 514.5C, General Minimum Integrity Curve per Figure 514.5C-17 with overall level of 7.7 G rms for 1 hour per axis.
Shock MIL-STD-810F, Method 516.5, Procedure I, Functional Shock, 40 g. MIL-S-901D, Lightweight Hammer Shock, 3 impacts/axis, 1,3,5 ft. MIL-STD-202F, Method 213B, 60 g, 9 ms half sine. MIL-STD-202F, Method 213B, 75 g, 11 ms Saw Tooth Shock.
Acceleration MIL-STD-810F, Method 513.5, Procedure II, table 513.5-II, Operational, 2-7 g, 6 directions.
Humidity MIL-STD-810F, Method 507.4.
Solder Test MIL-STD-202G, Method 208H, 8 hour aging.

■ ENVIRONMENTAL STRESS SCREENING

Parameter	H-Grade	M-Grade
Operating temperature	-40°C to +100°C	-55°C to +100°C
Storage temperature	-55°C to +125°C	-65°C to +125°C
Temperature cycling*	12 cycles -65°C to +100°C	12 cycles -65°C to +100°C
Ambient test @ 25°C	Yes	Yes
Power cycling burn-in	12 hours, 29 cycles	24 hours, 58 cycles
Functional and parametric ATE tests	-40°C and +100°C	-55°C and +100°C
Hi-Pot test	Yes	Yes
Visual inspection	Yes	Yes
Test data	vicorpower.com	vicorpower.com

*Temperature cycled with power off, 17°C per minute rate of change.

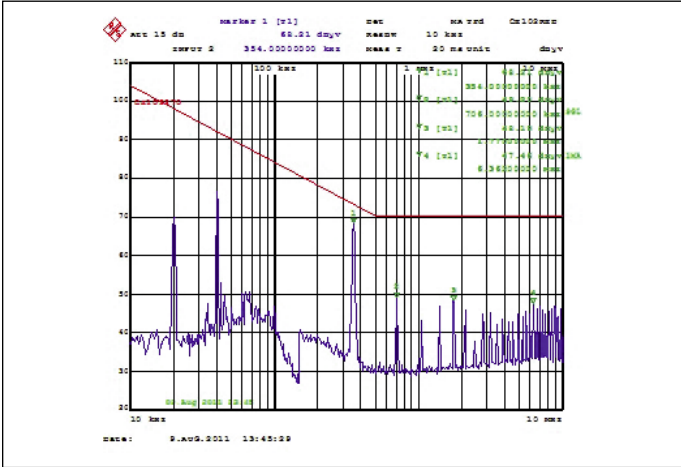

Figure 1 – Conducted noise; M-FIAM3 and V300A48C500BG DC-DC converter operating at 270 Vdc input at 450 W.

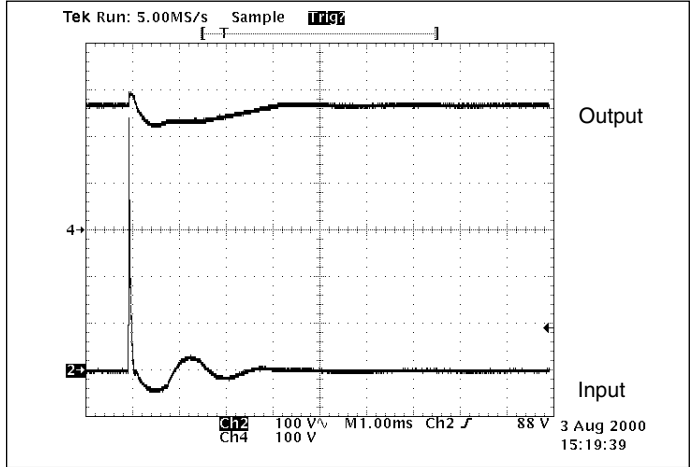

Figure 2 – Transient Immunity; M-FIAM3 output response to an input transient.

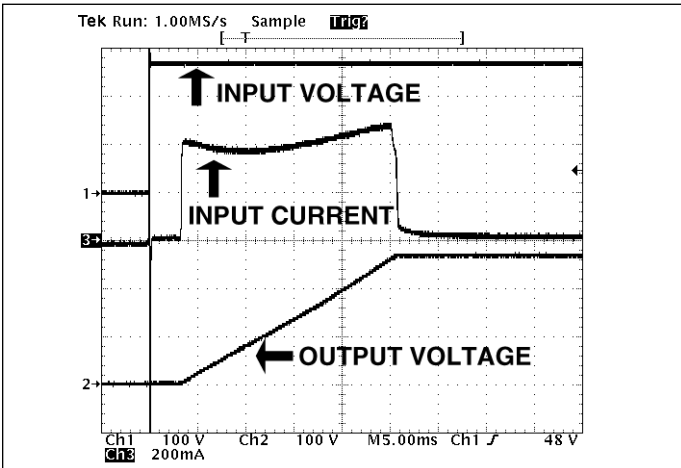

Figure 3–Inrush Limiting; Inrush current with 22 μ F external capacitance, (C1 in Figure 5)

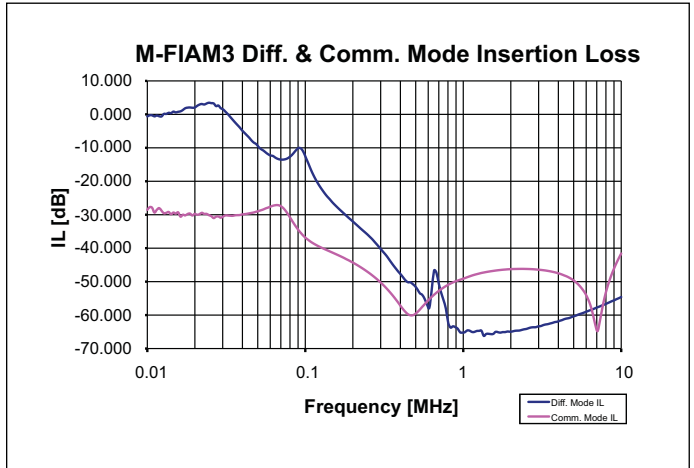

Figure 4–Insertion Loss Curve

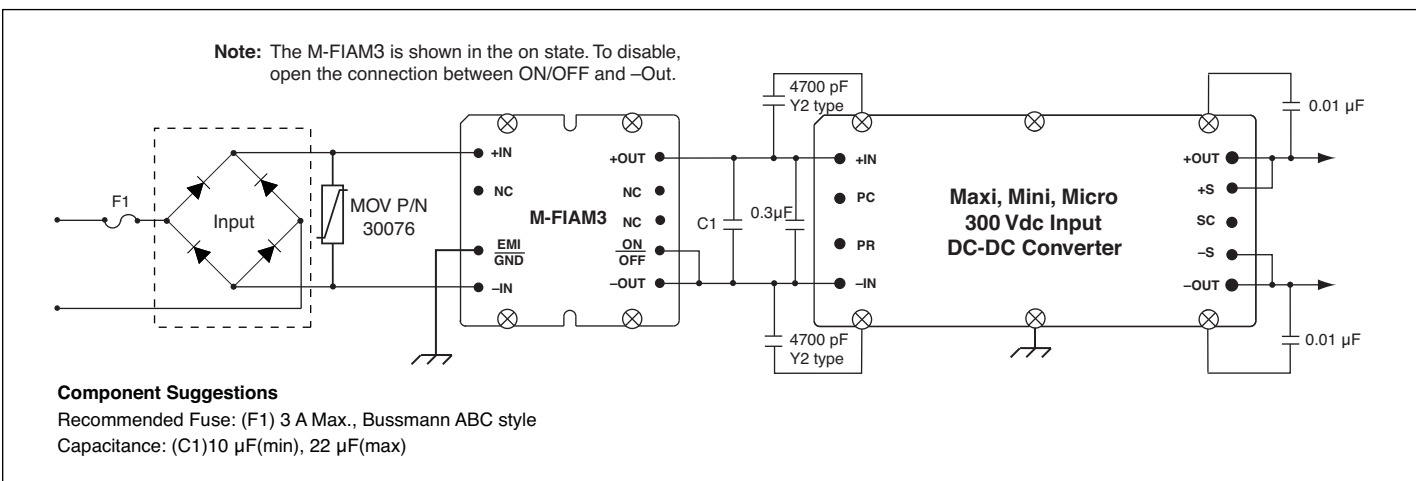

Figure 5 – Basic connection diagram with Transient, Surge Protection and Recommended Reverse Polarity Protection.

MECHANICAL DRAWINGS

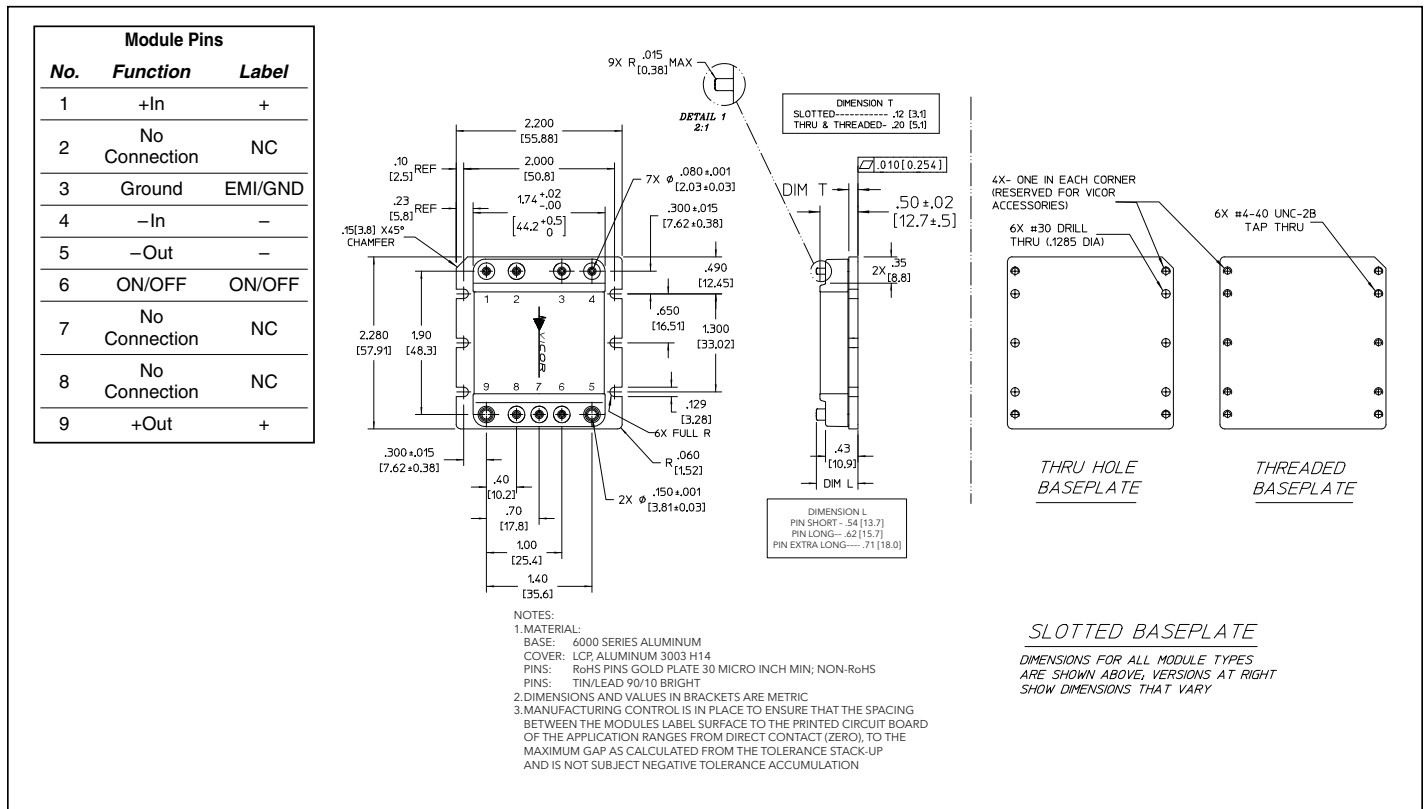

Figure 6 – Mechanical diagram

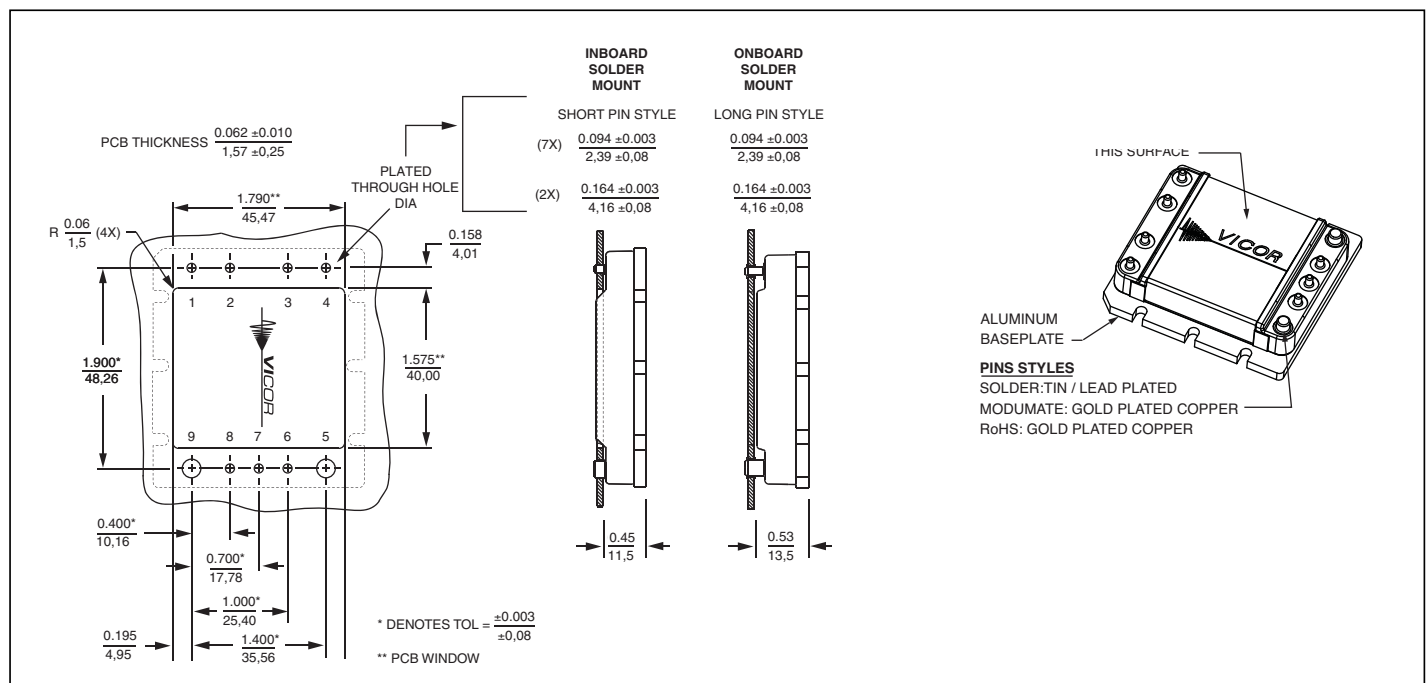

Figure 7 – PCB Mounting Specifications

Vicor's comprehensive line of power solutions includes high density AC-DC and DC-DC modules and accessory components, fully configurable AC-DC and DC-DC power supplies, and complete custom power systems.

Information furnished by Vicor is believed to be accurate and reliable. However, no responsibility is assumed by Vicor for its use. Vicor makes no representations or warranties with respect to the accuracy or completeness of the contents of this publication. Vicor reserves the right to make changes to any products, specifications, and product descriptions at any time without notice. Information published by Vicor has been checked and is believed to be accurate at the time it was printed; however, Vicor assumes no responsibility for inaccuracies. Testing and other quality controls are used to the extent Vicor deems necessary to support Vicor's product warranty. Except where mandated by government requirements, testing of all parameters of each product is not necessarily performed.

Specifications are subject to change without notice.

Vicor's Standard Terms and Conditions

All sales are subject to Vicor's Standard Terms and Conditions of Sale, which are available on Vicor's webpage or upon request.

Product Warranty

In Vicor's standard terms and conditions of sale, Vicor warrants that its products are free from non-conformity to its Standard Specifications (the "Express Limited Warranty"). This warranty is extended only to the original Buyer for the period expiring two (2) years after the date of shipment and is not transferable.

UNLESS OTHERWISE EXPRESSLY STATED IN A WRITTEN SALES AGREEMENT SIGNED BY A DULY AUTHORIZED VICOR SIGNATORY, VICOR DISCLAIMS ALL REPRESENTATIONS, LIABILITIES, AND WARRANTIES OF ANY KIND (WHETHER ARISING BY IMPLICATION OR BY OPERATION OF LAW) WITH RESPECT TO THE PRODUCTS, INCLUDING, WITHOUT LIMITATION, ANY WARRANTIES OR REPRESENTATIONS AS TO MERCHANTABILITY, FITNESS FOR PARTICULAR PURPOSE, INFRINGEMENT OF ANY PATENT, COPYRIGHT, OR OTHER INTELLECTUAL PROPERTY RIGHT, OR ANY OTHER MATTER.

This warranty does not extend to products subjected to misuse, accident, or improper application, maintenance, or storage. Vicor shall not be liable for collateral or consequential damage. Vicor disclaims any and all liability arising out of the application or use of any product or circuit and assumes no liability for applications assistance or buyer product design. Buyers are responsible for their products and applications using Vicor products and components. Prior to using or distributing any products that include Vicor components, buyers should provide adequate design, testing and operating safeguards.

Vicor will repair or replace defective products in accordance with its own best judgment. For service under this warranty, the buyer must contact Vicor to obtain a Return Material Authorization (RMA) number and shipping instructions. Products returned without prior authorization will be returned to the buyer. The buyer will pay all charges incurred in returning the product to the factory. Vicor will pay all reshipment charges if the product was defective within the terms of this warranty.

Life Support Policy

VICOR'S PRODUCTS ARE NOT AUTHORIZED FOR USE AS CRITICAL COMPONENTS IN LIFE SUPPORT DEVICES OR SYSTEMS WITHOUT THE EXPRESS PRIOR WRITTEN APPROVAL OF THE CHIEF EXECUTIVE OFFICER AND GENERAL COUNSEL OF VICOR CORPORATION. As used herein, life support devices or systems are devices which (a) are intended for surgical implant into the body, or (b) support or sustain life and whose failure to perform when properly used in accordance with instructions for use provided in the labeling can be reasonably expected to result in a significant injury to the user. A critical component is any component in a life support device or system whose failure to perform can be reasonably expected to cause the failure of the life support device or system or to affect its safety or effectiveness. Per Vicor Terms and Conditions of Sale, the user of Vicor products and components in life support applications assumes all risks of such use and indemnifies Vicor against all liability and damages.

Intellectual Property Notice

Vicor and its subsidiaries own Intellectual Property (including issued U.S. and Foreign Patents and pending patent applications) relating to the products described in this data sheet. No license, whether express, implied, or arising by estoppel or otherwise, to any intellectual property rights is granted by this document. Interested parties should contact Vicor's Intellectual Property Department.

Vicor Corporation
25 Frontage Road
Andover, MA, USA 01810
Tel: 800-735-6200
Fax: 978-475-6715

email

Customer Service: custserv@vicorpower.com
Technical Support: apps@vicorpower.com



**Стандарт
Электрон
Связь**

Мы молодая и активно развивающаяся компания в области поставок электронных компонентов. Мы поставляем электронные компоненты отечественного и импортного производства напрямую от производителей и с крупнейших складов мира.

Благодаря сотрудничеству с мировыми поставщиками мы осуществляем комплексные и плановые поставки широчайшего спектра электронных компонентов.

Собственная эффективная логистика и склад в обеспечивает надежную поставку продукции в точно указанные сроки по всей России.

Мы осуществляем техническую поддержку нашим клиентам и предпродажную проверку качества продукции. На все поставляемые продукты мы предоставляем гарантию .

Осуществляем поставки продукции под контролем ВП МО РФ на предприятия военно-промышленного комплекса России , а также работаем в рамках 275 ФЗ с открытием отдельных счетов в уполномоченном банке. Система менеджмента качества компании соответствует требованиям ГОСТ ISO 9001.

Минимальные сроки поставки, гибкие цены, неограниченный ассортимент и индивидуальный подход к клиентам являются основой для выстраивания долгосрочного и эффективного сотрудничества с предприятиями радиоэлектронной промышленности, предприятиями ВПК и научно-исследовательскими институтами России.

С нами вы становитесь еще успешнее!

Наши контакты:

Телефон: +7 812 627 14 35

Электронная почта: sales@st-electron.ru

Адрес: 198099, Санкт-Петербург,
Промышленная ул, дом № 19, литера Н,
помещение 100-Н Офис 331