

# DATA SHEET

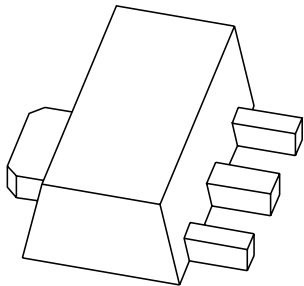

## **BF621; BF623** PNP high-voltage transistors

Product data sheet  
Supersedes data of 1999 Apr 21

2004 Dec 14

# PNP high-voltage transistors

# BF621; BF623

### FEATURES

- Low current (max. 50 mA)
- High voltage (max. 300 V).

### APPLICATIONS

- Video output stages.

### DESCRIPTION

PNP high-voltage transistor in a SOT89 plastic package.  
NPN complements: BF620 and BF622.

### MARKING

TYPE NUMBER	MARKING CODE
BF621	DF
BF623	DB

### PINNING

PIN	DESCRIPTION
1	emitter
2	collector
3	base

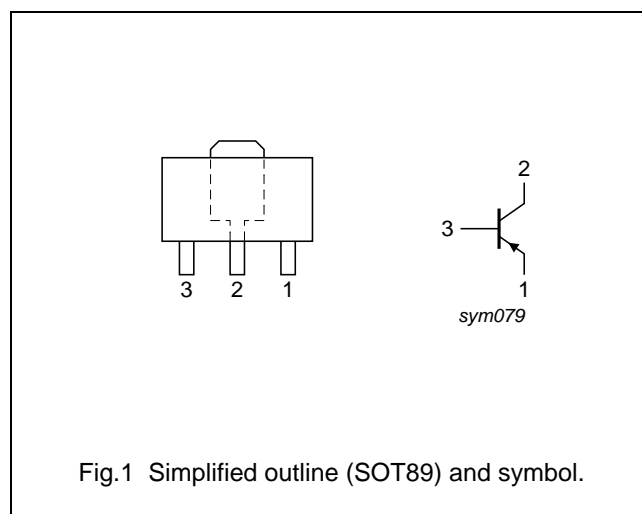

Fig.1 Simplified outline (SOT89) and symbol.

### ORDERING INFORMATION

TYPE NUMBER	PACKAGE		
	NAME	DESCRIPTION	VERSION
BF621	SC-62	plastic surface mounted package; collector pad for good heat transfer; 3 leads	SOT89
BF623			

## PNP high-voltage transistors

BF621; BF623

**LIMITING VALUES**

In accordance with the Absolute Maximum Rating System (IEC 60134).

SYMBOL	PARAMETER	CONDITIONS	MIN.	MAX.	UNIT
V <sub>CBO</sub>	collector-base voltage	open emitter			
	BF621		–	–300	V
	BF623		–	–250	V
V <sub>CEO</sub>	collector-emitter voltage	open base			
	BF621		–	–300	V
	BF623		–	–250	V
V <sub>EBO</sub>	emitter-base voltage	open collector	–	–5	V
I <sub>C</sub>	collector current (DC)		–	–50	mA
I <sub>CM</sub>	peak collector current		–	–100	mA
I <sub>BM</sub>	peak base current		–	–50	mA
P <sub>tot</sub>	total power dissipation	T <sub>amb</sub> ≤ 25 °C			
		note 1	–	0.5	W
		note 2	–	0.8	W
		note 3	–	1.1	W
T <sub>stg</sub>	storage temperature		–65	+150	°C
T <sub>j</sub>	junction temperature		–	150	°C
T <sub>amb</sub>	ambient temperature		–65	+150	°C

**Notes**

1. Device mounted on a printed-circuit board, single-sided copper, tin-plated and standard footprint.
2. Device mounted on a printed-circuit board, single-sided copper, tin-plated and mounting pad for collector 1 cm<sup>2</sup>.
3. Device mounted on a printed-circuit board, single-sided copper, tin-plated and mounting pad for collector 6 cm<sup>2</sup>.

# PNP high-voltage transistors

# BF621; BF623

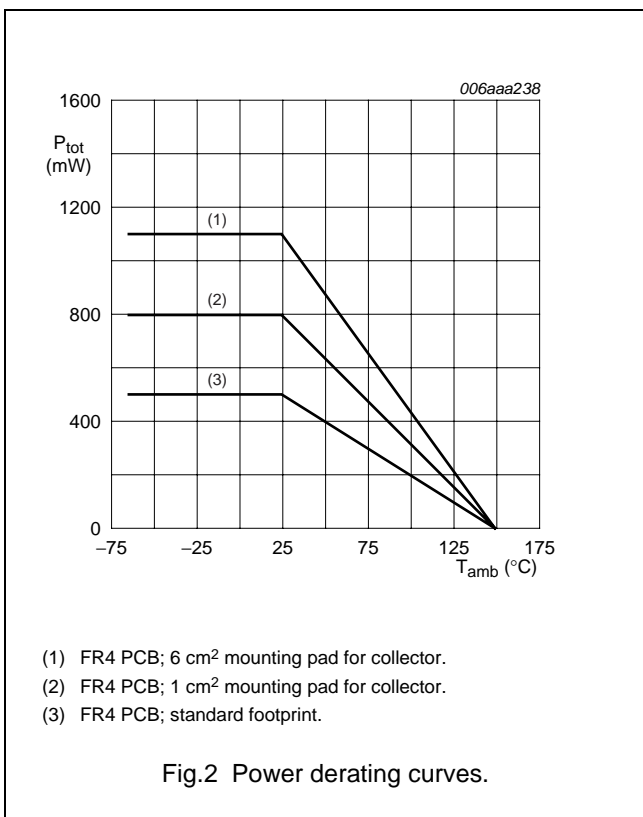

PNP high-voltage transistors

BF621; BF623

**THERMAL CHARACTERISTICS**

SYMBOL	PARAMETER	CONDITIONS	VALUE	UNIT
R <sub>th(j-a)</sub>	thermal resistance from junction to ambient	in free air		
		note 1	250	K/W
		note 2	156	K/W
		note 3	113	K/W
R <sub>th(j-s)</sub>	thermal resistance from junction to soldering point		30	K/W

**Notes**

1. Device mounted on a printed-circuit board, single-sided copper, tin-plated and standard footprint.
2. Device mounted on a printed-circuit board, single-sided copper, tin-plated and mounting pad for collector 1 cm<sup>2</sup>.
3. Device mounted on a printed-circuit board, single-sided copper, tin-plated and mounting pad for collector 6 cm<sup>2</sup>.

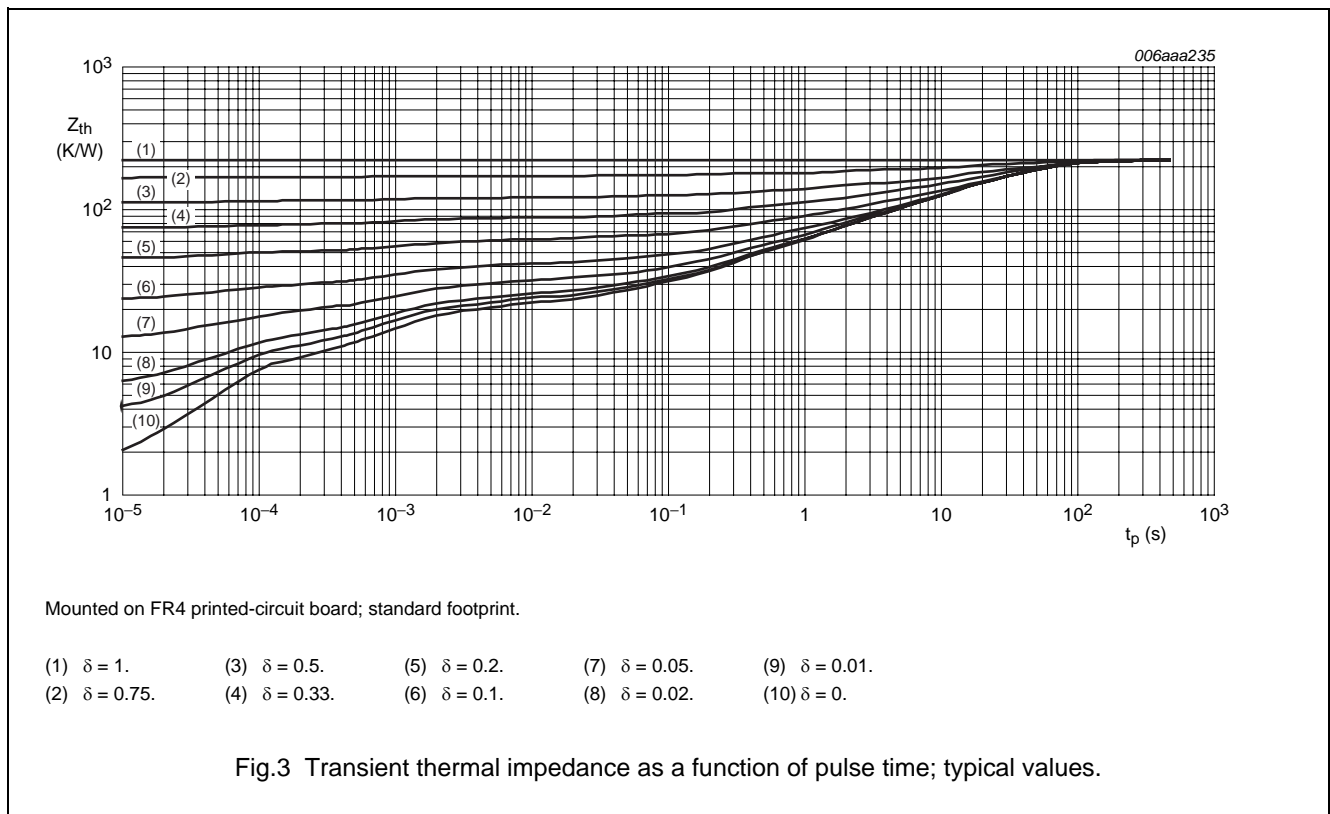

PNP high-voltage transistors

BF621; BF623

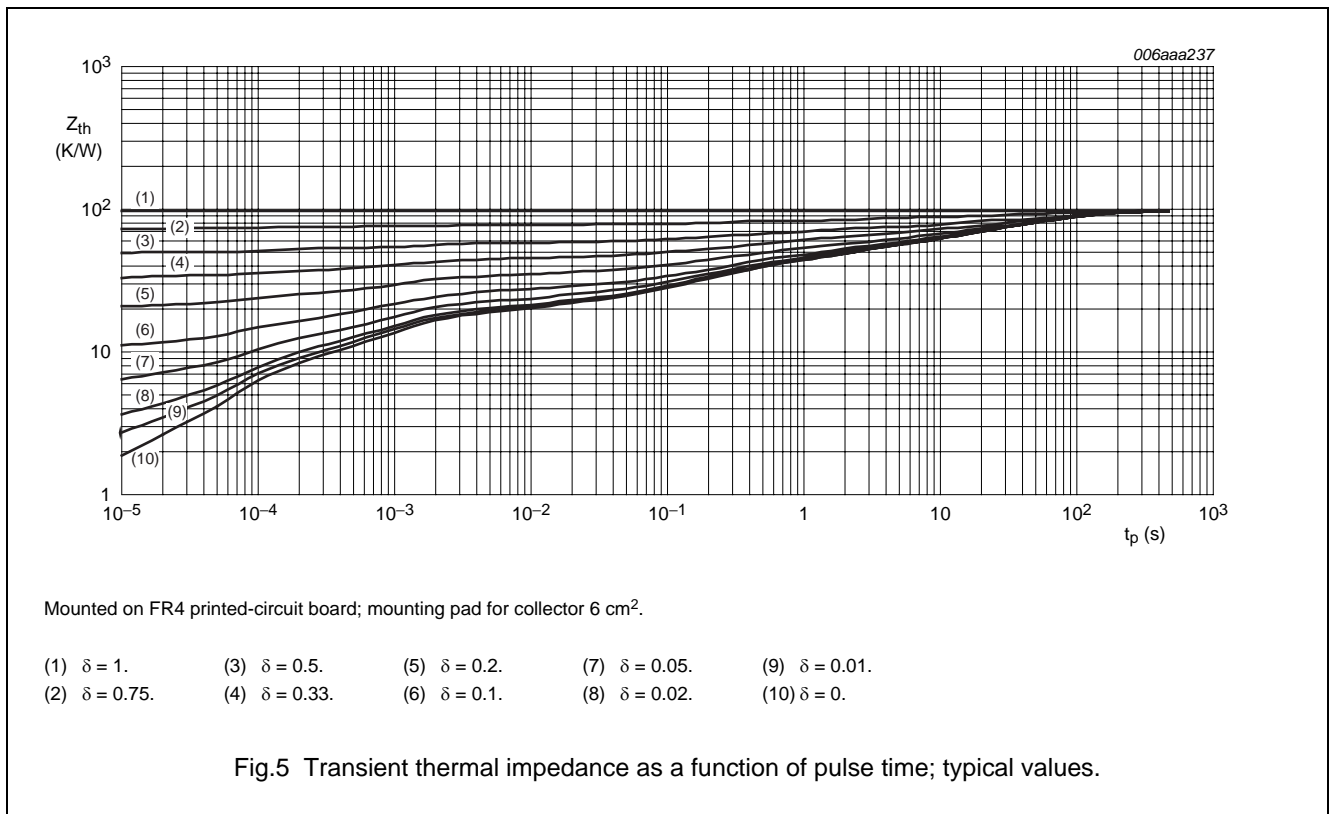
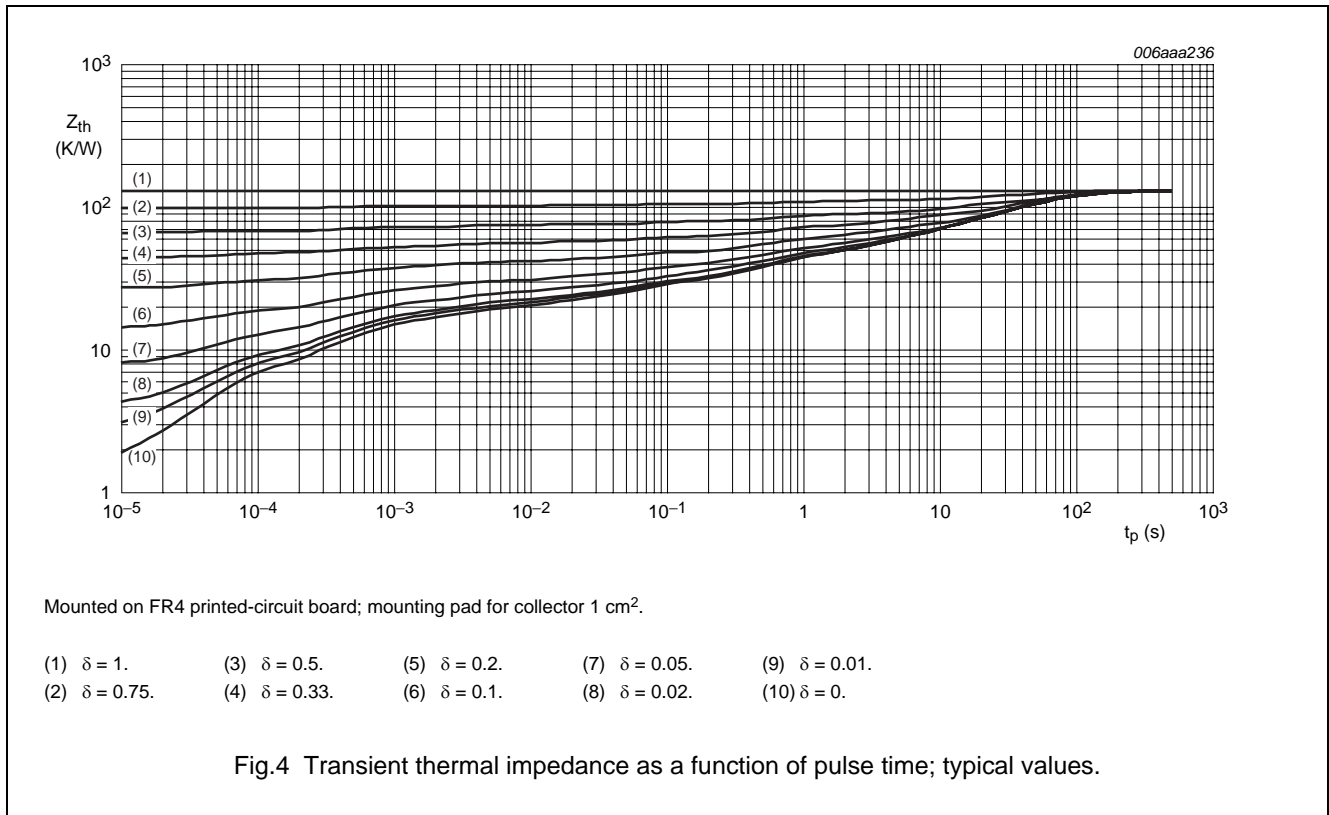

## PNP high-voltage transistors

BF621; BF623

**CHARACTERISTICS** $T_{amb} = 25\text{ °C}$  unless otherwise specified.

SYMBOL	PARAMETER	CONDITIONS	MIN.	MAX.	UNIT
$I_{CBO}$	collector-base cut-off current	$I_E = 0\text{ A}; V_{CB} = -200\text{ V}$	–	–10	nA
		$I_E = 0\text{ A}; V_{CB} = -200\text{ V}; T_j = 150\text{ °C}$	–	–10	$\mu\text{A}$
$I_{EBO}$	emitter-base cut-off current	$I_C = 0\text{ A}; V_{EB} = -5\text{ V}$	–	–50	nA
$h_{FE}$	DC current gain	$I_C = -25\text{ mA}; V_{CE} = -20\text{ V}$	50	–	
$V_{CEsat}$	collector-emitter saturation voltage	$I_C = -30\text{ mA}; I_B = -5\text{ mA}$	–	–800	mV
$C_{re}$	feedback capacitance	$I_C = i_c = 0\text{ A}; V_{CE} = -30\text{ V}; f = 1\text{ MHz}$	–	1.6	pF
$f_T$	transition frequency	$I_C = -10\text{ mA}; V_{CE} = -10\text{ V}; f = 100\text{ MHz}$	60	–	MHz

PNP high-voltage transistors

BF621; BF623

PACKAGE OUTLINE

Plastic surface-mounted package; collector pad for good heat transfer; 3 leads

SOT89

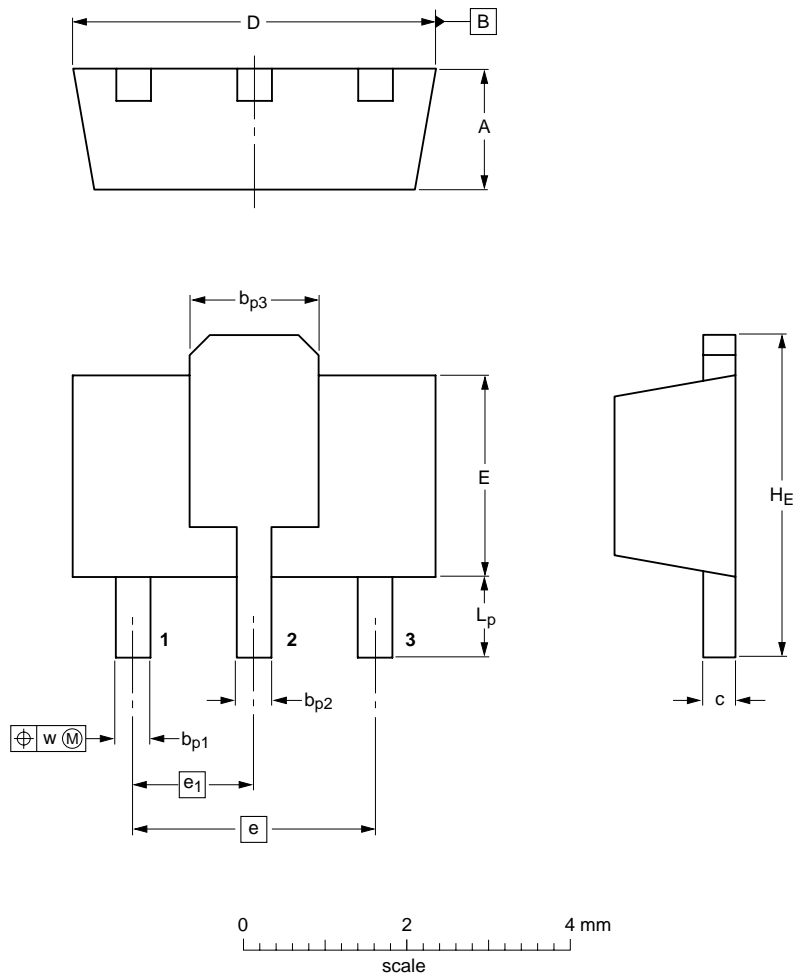

DIMENSIONS (mm are the original dimensions)

UNIT	A	b <sub>p1</sub>	b <sub>p2</sub>	b <sub>p3</sub>	c	D	E	e	e <sub>1</sub>	H <sub>E</sub>	L <sub>p</sub>	w
mm	1.6 1.4	0.48 0.35	0.53 0.40	1.8 1.4	0.44 0.23	4.6 4.4	2.6 2.4	3.0	1.5	4.25 3.75	1.2 0.8	0.13

OUTLINE VERSION	REFERENCES			EUROPEAN PROJECTION	ISSUE DATE
	IEC	JEDEC	JEITA		
SOT89		TO-243	SC-62		04-08-03 06-03-16



PNP high-voltage transistors

BF621; BF623

**DATA SHEET STATUS**

DOCUMENT STATUS <sup>(1)</sup>	PRODUCT STATUS <sup>(2)</sup>	DEFINITION
Objective data sheet	Development	This document contains data from the objective specification for product development.
Preliminary data sheet	Qualification	This document contains data from the preliminary specification.
Product data sheet	Production	This document contains the product specification.

**Notes**

1. Please consult the most recently issued document before initiating or completing a design.
2. The product status of device(s) described in this document may have changed since this document was published and may differ in case of multiple devices. The latest product status information is available on the Internet at URL <http://www.nxp.com>.

**DISCLAIMERS**

**General** — Information in this document is believed to be accurate and reliable. However, NXP Semiconductors does not give any representations or warranties, expressed or implied, as to the accuracy or completeness of such information and shall have no liability for the consequences of use of such information.

**Right to make changes** — NXP Semiconductors reserves the right to make changes to information published in this document, including without limitation specifications and product descriptions, at any time and without notice. This document supersedes and replaces all information supplied prior to the publication hereof.

**Suitability for use** — NXP Semiconductors products are not designed, authorized or warranted to be suitable for use in medical, military, aircraft, space or life support equipment, nor in applications where failure or malfunction of an NXP Semiconductors product can reasonably be expected to result in personal injury, death or severe property or environmental damage. NXP Semiconductors accepts no liability for inclusion and/or use of NXP Semiconductors products in such equipment or applications and therefore such inclusion and/or use is at the customer's own risk.

**Applications** — Applications that are described herein for any of these products are for illustrative purposes only. NXP Semiconductors makes no representation or warranty that such applications will be suitable for the specified use without further testing or modification.

**Limiting values** — Stress above one or more limiting values (as defined in the Absolute Maximum Ratings System of IEC 60134) may cause permanent damage to the device. Limiting values are stress ratings only and operation of the device at these or any other conditions

above those given in the Characteristics sections of this document is not implied. Exposure to limiting values for extended periods may affect device reliability.

**Terms and conditions of sale** — NXP Semiconductors products are sold subject to the general terms and conditions of commercial sale, as published at <http://www.nxp.com/profile/terms>, including those pertaining to warranty, intellectual property rights infringement and limitation of liability, unless explicitly otherwise agreed to in writing by NXP Semiconductors. In case of any inconsistency or conflict between information in this document and such terms and conditions, the latter will prevail.

**No offer to sell or license** — Nothing in this document may be interpreted or construed as an offer to sell products that is open for acceptance or the grant, conveyance or implication of any license under any copyrights, patents or other industrial or intellectual property rights.

**Export control** — This document as well as the item(s) described herein may be subject to export control regulations. Export might require a prior authorization from national authorities.

**Quick reference data** — The Quick reference data is an extract of the product data given in the Limiting values and Characteristics sections of this document, and as such is not complete, exhaustive or legally binding.

# ***NXP Semiconductors***

## **Customer notification**

This data sheet was changed to reflect the new company name NXP Semiconductors, including new legal definitions and disclaimers. No changes were made to the technical content, except for package outline drawings which were updated to the latest version.

## **Contact information**

For additional information please visit: <http://www.nxp.com>

For sales offices addresses send e-mail to: [salesaddresses@nxp.com](mailto:salesaddresses@nxp.com)

© NXP B.V. 2009

All rights are reserved. Reproduction in whole or in part is prohibited without the prior written consent of the copyright owner.

The information presented in this document does not form part of any quotation or contract, is believed to be accurate and reliable and may be changed without notice. No liability will be accepted by the publisher for any consequence of its use. Publication thereof does not convey nor imply any license under patent- or other industrial or intellectual property rights.

Printed in The Netherlands

R75/04/pp10

Date of release: 2004 Dec 14

Document order number: 9397 750 13868

founded by

**PHILIPS**



## Стандарт Электрон Связь

Мы молодая и активно развивающаяся компания в области поставок электронных компонентов. Мы поставляем электронные компоненты отечественного и импортного производства напрямую от производителей и с крупнейших складов мира.

Благодаря сотрудничеству с мировыми поставщиками мы осуществляем комплексные и плановые поставки широчайшего спектра электронных компонентов.

Собственная эффективная логистика и склад в обеспечивает надежную поставку продукции в точно указанные сроки по всей России.

Мы осуществляем техническую поддержку нашим клиентам и предпродажную проверку качества продукции. На все поставляемые продукты мы предоставляем гарантию .

Осуществляем поставки продукции под контролем ВП МО РФ на предприятия военно-промышленного комплекса России , а также работаем в рамках 275 ФЗ с открытием отдельных счетов в уполномоченном банке. Система менеджмента качества компании соответствует требованиям ГОСТ ISO 9001.

Минимальные сроки поставки, гибкие цены, неограниченный ассортимент и индивидуальный подход к клиентам являются основой для выстраивания долгосрочного и эффективного сотрудничества с предприятиями радиоэлектронной промышленности, предприятиями ВПК и научно-исследовательскими институтами России.

С нами вы становитесь еще успешнее!

### Наши контакты:

**Телефон:** +7 812 627 14 35

**Электронная почта:** [sales@st-electron.ru](mailto:sales@st-electron.ru)

**Адрес:** 198099, Санкт-Петербург,  
Промышленная ул, дом № 19, литера Н,  
помещение 100-Н Офис 331