



- Features :
  - Constant current design
  - Universal AC input / Full range (up to 305VAC)
  - Built-in active PFC function
  - High efficiency up to 91.5%
  - Protections: Short circuit / Over voltage / Over temperature
  - Cooling by free air convection
  - Output current adjustable through output cable or internal potentiometer
  - IP67 / IP65 design for indoor or outdoor installations
  - Three in one dimming function (1~10Vdc or 10V PWM signal or resistance)
  - Suitable for dry / damp / wet locations
  - 5 years warranty (Note.5)



HLG-80H-C350  A : IP65 rated. Constant current level can be adjusted through internal potentiometer.  
 B : IP67 rated. Constant current level adjustable through output cable with 1~10Vdc or 10V PWM signal or resistance.  
 D (option) : IP67 rated. Timer dimming function, contact MEAN WELL for details.

### SPECIFICATION

MODEL		HLG-80H-C350 <input type="checkbox"/>	HLG-80H-C700 <input type="checkbox"/>
OUTPUT	RATED CURRENT	350mA	700mA
	CURRENT ACCURACY	± 5.0%	
	CONSTANT CURRENT REGION Note.6	A type : 128V ~ 257V    B type : 167V ~ 257V	A type : 64V ~ 129V    B type : 84V ~ 129V
	RATED POWER	89.95W	90.3W
	RIPPLE CURRENT	± 5%	
	RIPPLE & NOISE	1Vp-p	0.5Vp-p
	CURRENT ADJ. RANGE	Can be adjusted by internal potentiometer A type only 210 ~ 350mA	
	LINE REGULATION	± 1%	
	SETUP, RISE TIME	500ms, 80ms at full load    230VAC / 115VAC	
	HOLD UP TIME (Typ.)	16ms at full load    230VAC / 115VAC	
INPUT	VOLTAGE RANGE Note.2	90 ~ 305VAC    127VDC ~ 431VDC	
	FREQUENCY RANGE	47 ~ 63Hz	
	POWER FACTOR (Typ.)	PF>0.98/115VAC, PF>0.96/230VAC, PF>0.94/277VAC at full load (Please refer to "Power Factor Characteristic" curve)	
	TOTAL HARMONIC DISTORTION	THD< 20% when output loading ≥ 60% at 115VAC/230VAC input and output loading ≥ 75% at 277VAC input	
	EFFICIENCY (Typ.)	91.5%	91.5%
	AC CURRENT (Typ.)	0.88A / 115VAC    0.45A / 230VAC    0.38A / 277VAC	
	INRUSH CURRENT (Typ.)	COLD START 60A(twidth=410μs measured at 50% Ipeak) at 230VAC	
	MAX. No. of PSUs on 16A CIRCUIT BREAKER	4 units (circuit breaker of type B) / 8 units (circuit breaker of type C) at 230VAC	
	LEAKAGE CURRENT	<0.75mA / 277VAC	
PROTECTION	SHORT CIRCUIT	Hiccup mode, recovers automatically after fault condition is removed	
	OVER VOLTAGE	300 ~ 340V	150 ~ 170V
	OVER TEMPERATURE	Shut down o/p voltage, re-power on to recover Protection type : Shut down o/p voltage with auto-recovery or re-power on to recovery	
ENVIRONMENT	WORKING TEMP.	-40 ~ +70°C (Refer to "Derating Curve")	
	WORKING HUMIDITY	10 ~ 95% RH non-condensing	
	STORAGE TEMP., HUMIDITY	-40 ~ +80°C, 10 ~ 95% RH	
	TEMP. COEFFICIENT	± 0.03%/°C (0 ~ 50°C)	
	VIBRATION	10 ~ 500Hz, 5G 12min./1cycle, period for 72min. each along X, Y, Z axes	
SAFETY & EMC	SAFETY STANDARDS Note.3	UL8750, CSA C22.2 No. 250.0-08, EN61347-1, EN61347-2-13 independent, IP65 or IP67 approved	
	WITHSTAND VOLTAGE	I/P-O/P:3.75KVAC    I/P-FG:2KVAC    O/P-FG:1.5KVAC	
	ISOLATION RESISTANCE	I/P-O/P, I/P-FG, O/P-FG:100M Ohms / 500VDC / 25°C / 70% RH	
	EMC EMISSION	Compliance to EN55015, EN61000-3-2 Class C (≥ 50% load) ; EN61000-3-3	
	EMC IMMUNITY	Compliance to EN61000-4-2,3,4,5,6,8,11, EN61547, heavy industry level (surge L,N-FG: 4KV), criteria A	
OTHERS	MTBF	309.7K hrs min.    MIL-HDBK-217F (25°C)	
	DIMENSION	195.6*61.5*38.8 mm (L*W*H)	
	PACKING	0.84Kg; 16pcs/14.4Kg/0.54CUFT	
NOTE	1. All parameters NOT specially mentioned are measured at 230VAC input, rated load and 25°C of ambient temperature. 2. Derating may be needed under low input voltages. Please check the static characteristics for more details. 3. Safety and EMC design refer to EN60598-1, CNS15233, GB7000.1. 4. The power supply is considered as a component that will be operated in combination with final equipment. Since EMC performance will be affected by the complete installation, the final equipment manufacturers must re-qualify EMC Directive on the complete installation again. 5. Refer to warranty statement. 6. Please refer to "DRIVING METHODS OF LED MODULE". 7. To fulfill requirements of the latest ErP regulation for lighting fixtures, this LED power supply can only be used behind a switch without permanently connected to the mains.		

**Mechanical Specification**

Case No.997A

Unit:mm

**A Type:(HLG-80H-C\_A)**

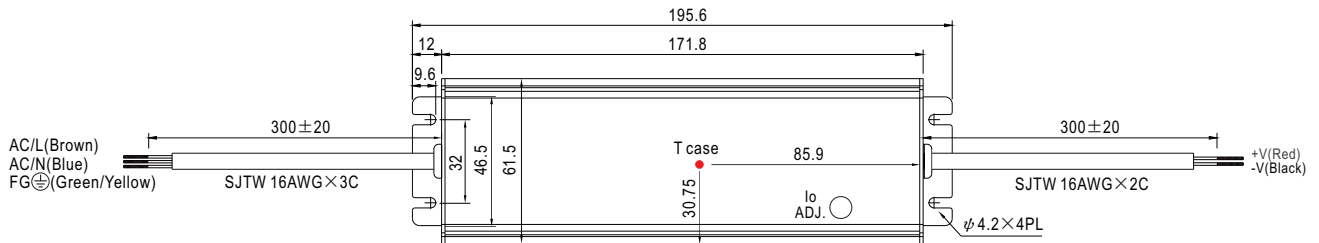

※ T case: Max. Case Temperature.



※ IP65 rated. Constant current level can be adjusted through internal potentiometer.  
(Can access by removing the rubber stopper on the case.)

**B Type:(HLG-80H-C\_B)**

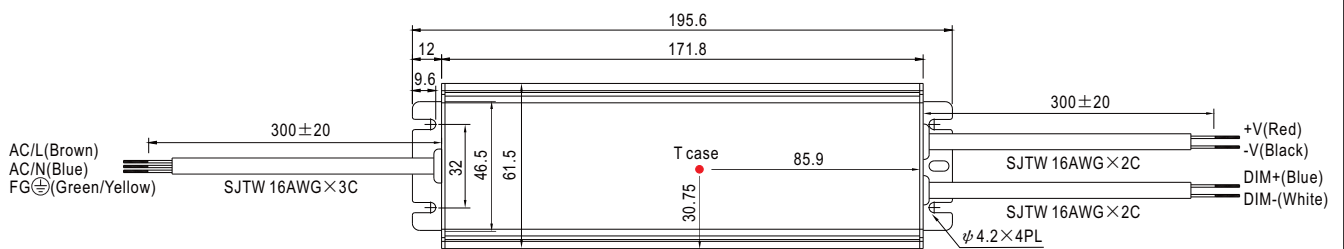

※ T case: Max. Case Temperature.



D Type:(HLG-80H-C\_D)

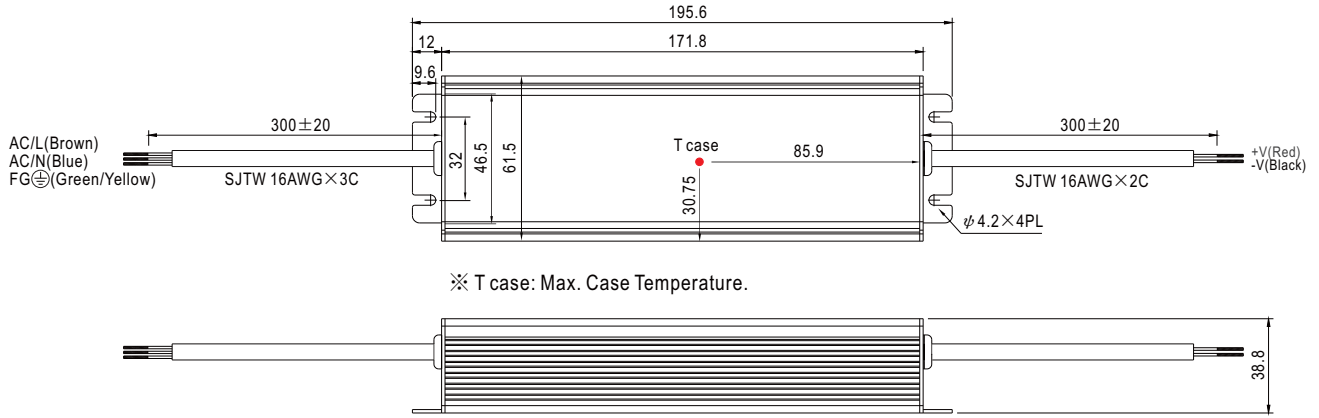

※ IP67 rated. Timer dimming function, contact MEAN WELL for details.

■ Block Diagram

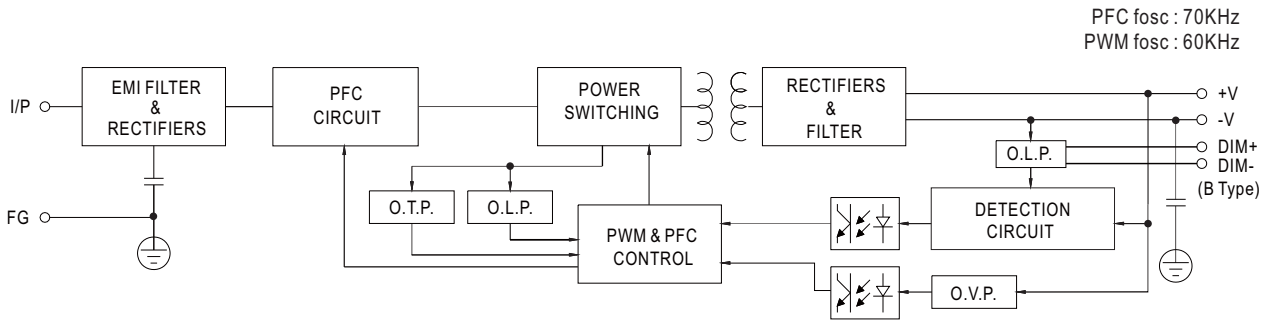

■ Derating Curve

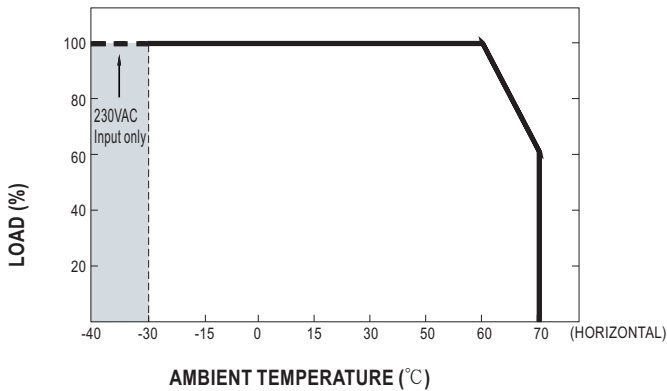

■ Static Characteristics

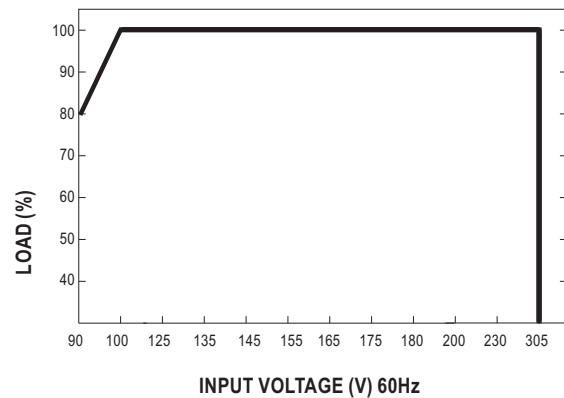

### Power Factor Characteristic

#### Constant Current Mode

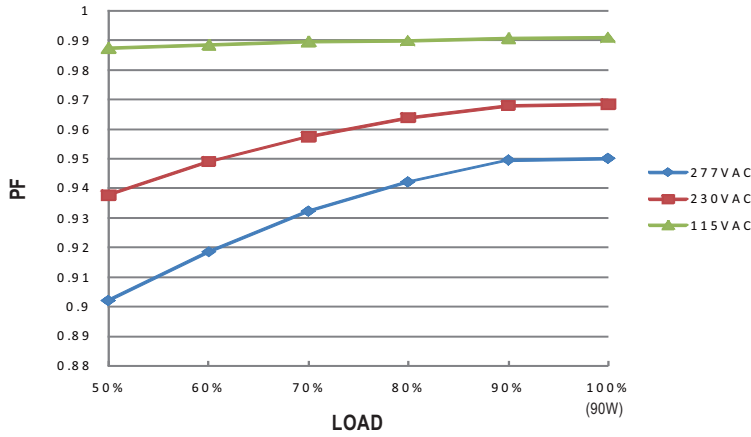

### EFFICIENCY vs LOAD (HLG-80H-C700A Model)

HLG-80H-C series possess superior working efficiency that up to 92% can be reached in field applications.

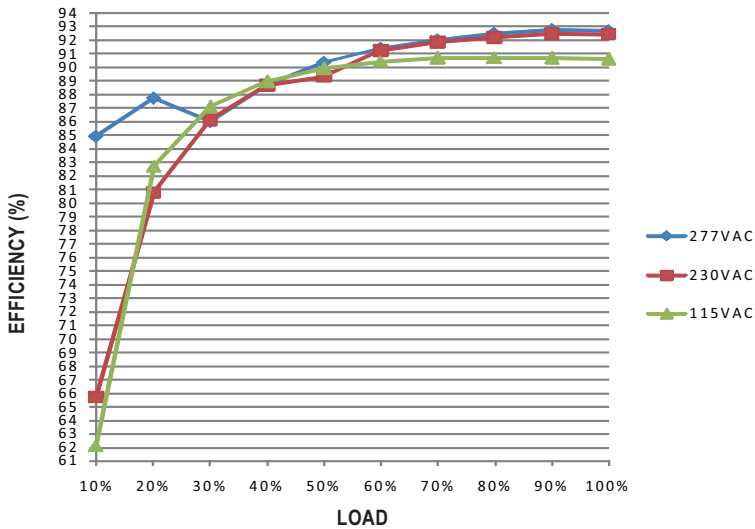

### DRIVING METHODS OF LED MODULE

A typical LED power supply may work in "constant current mode (CC)" to drive the LEDs.

Mean Well's LED power supply with CC characteristic can be operated at CC mode (direct drive, at area (A)).

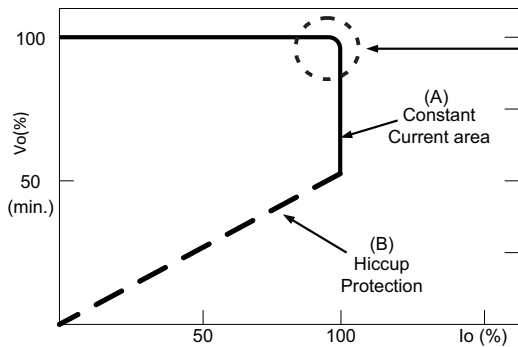

Typical LED power supply I-V curve

In the constant current region, the highest voltage at the output of the driver depends on the configuration of the end systems.

Should there be any compatibility issues, please contact MEAN WELL.

**DIMMING OPERATION (for B-type only)**

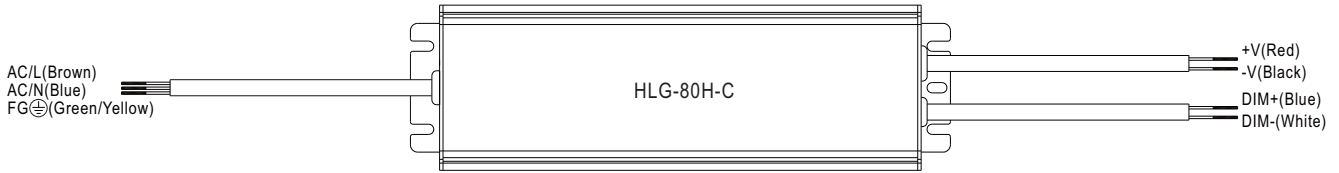

- ※ Built-in 3 in 1 dimming function, IP67 rated. Output constant current level can be adjusted through output cable by connecting a resistance or 1 ~ 10Vdc or 10V PWM signal between DIM+ and DIM-.
- ※ Please DO NOT connect "DIM-" to "-V".
- ※ Reference resistance value for output current adjustment (Typical)

Resistance value	Single driver	10KΩ	20KΩ	30KΩ	40KΩ	50KΩ	60KΩ	70KΩ	80KΩ	90KΩ	100KΩ	OPEN
	Multiple drivers (N=driver quantity for synchronized dimming operation)	10KΩ/N	20KΩ/N	30KΩ/N	40KΩ/N	50KΩ/N	60KΩ/N	70KΩ/N	80KΩ/N	90KΩ/N	100KΩ/N	-----
Percentage of rated current		10%	20%	30%	40%	50%	60%	70%	80%	90%	100%	95%~108%

※ 1 ~ 10V dimming function for output current adjustment (Typical)

Dimming value	1V	2V	3V	4V	5V	6V	7V	8V	9V	10V	OPEN
Percentage of rated current	10%	20%	30%	40%	50%	60%	70%	80%	90%	100%	95%~108%

※ 10V PWM signal for output current adjustment (Typical): Frequency range : 100Hz ~ 3KHz

Duty value	10%	20%	30%	40%	50%	60%	70%	80%	90%	100%	OPEN
Percentage of rated current	10%	20%	30%	40%	50%	60%	70%	80%	90%	100%	95%~108%

- ※ Using the built-in dimming function on B-type model can't turn the lighting fixture totally dark. Please refer to the connection method below to achieve 0% brightness of the lighting fixture connecting to the LED power supply unit.
- ※ Direct connecting to LEDs is suggested, but is not suitable for using additional drivers.

Dimming connection diagram for turning the lighting fixture ON/OFF :

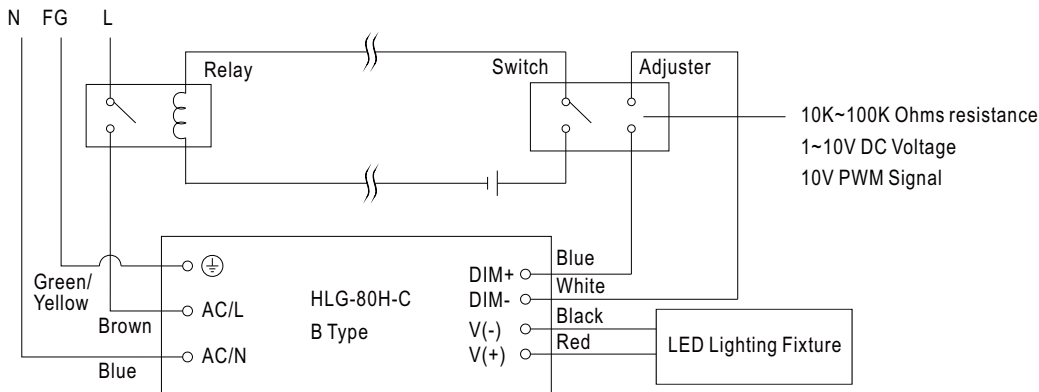

Using a switch and relay can turn ON/OFF the lighting fixture.

1. Output constant current level can be adjusted through output cable by connecting a resistance or 1~10Vdc or 10V PWM signal between DIM+ and DIM-.
2. The LED lighting fixture can be turned ON/OFF by the switch.

**WATERPROOF CONNECTION**

◎ Waterproof connector

Waterproof connector can be assembled on the output cable of HLG-80H-C to operate in dry/wet/damp or outdoor environment.

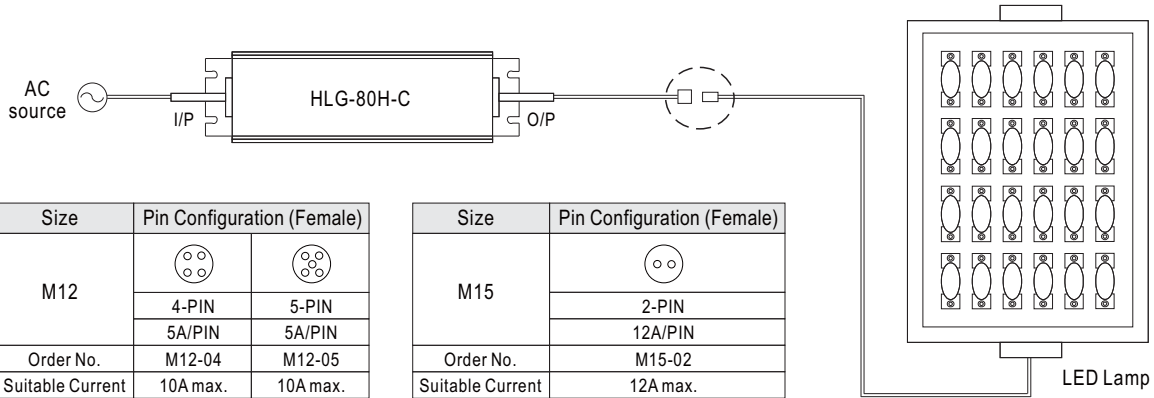

◎ Cable Joiner

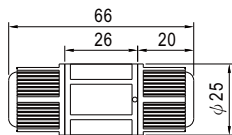

CJ04-1 suitable for 14AWG~16AWG  
 CJ04-2 suitable for 18AWG~22AWG



Up to four wires can be connected through this cable joiner by soldering or clamping by tools.

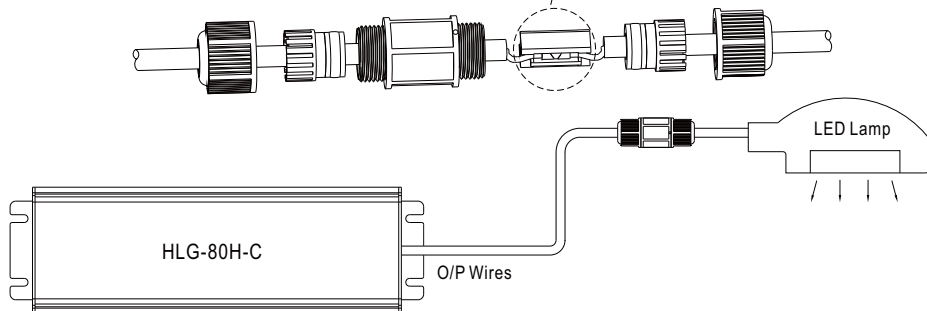

※CJ04 cable joiner can be purchased independently for user's own assembly.  
 MEAN WELL order No. : CJ04-1, CJ04-2.



## Стандарт Электрон Связь

Мы молодая и активно развивающаяся компания в области поставок электронных компонентов. Мы поставляем электронные компоненты отечественного и импортного производства напрямую от производителей и с крупнейших складов мира.

Благодаря сотрудничеству с мировыми поставщиками мы осуществляем комплексные и плановые поставки широчайшего спектра электронных компонентов.

Собственная эффективная логистика и склад в обеспечивает надежную поставку продукции в точно указанные сроки по всей России.

Мы осуществляем техническую поддержку нашим клиентам и предпродажную проверку качества продукции. На все поставляемые продукты мы предоставляем гарантию .

Осуществляем поставки продукции под контролем ВП МО РФ на предприятия военно-промышленного комплекса России , а также работаем в рамках 275 ФЗ с открытием отдельных счетов в уполномоченном банке. Система менеджмента качества компании соответствует требованиям ГОСТ ISO 9001.

Минимальные сроки поставки, гибкие цены, неограниченный ассортимент и индивидуальный подход к клиентам являются основой для выстраивания долгосрочного и эффективного сотрудничества с предприятиями радиоэлектронной промышленности, предприятиями ВПК и научно-исследовательскими институтами России.

С нами вы становитесь еще успешнее!

### Наши контакты:

**Телефон:** +7 812 627 14 35

**Электронная почта:** [sales@st-electron.ru](mailto:sales@st-electron.ru)

**Адрес:** 198099, Санкт-Петербург,  
Промышленная ул, дом № 19, литера Н,  
помещение 100-Н Офис 331