

## Highly integrated tuner for AM/FM car radio

Target specification

### Features

- Fully integrated VCO for world tuning
- AM/FM mixers with high image rejection
- Integrated AM-LNA and AM-PINDIODE
- Automatic self alignment for image rejection
- Digital IF signal processing, high performance and drift-free
- Integrated IF-filters with high selectivity, high dynamic range and FM adaptive bandwidth control
- High performance stereodecoder with noiseblanker
- I<sup>2</sup>C bus controlled
- Single 5 V supply
- LQFP44 package

### Description

The TDA7703 highly integrated tuner (HIT44) is part of a family of tuners for carradio applications.

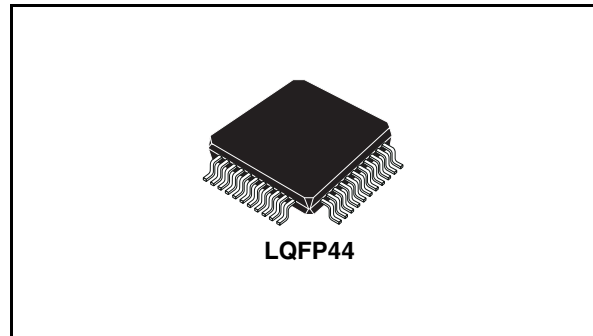

It contains mixers and IF amplifiers for AM and FM, fully integrated VCO and PLL synthesizer, IF-processing including adaptive bandwidth control (FM), stereo decoder on a single chip.

The utilization of digital signal processing results in numerous advantages against today's tuners:

- Very low number of external components
- Very small space occupation and easy application
- Very high selectivity due to digital filters
- High flexibility by software control
- Automatic image rejection alignment.

**Table 1. Device summary**

Order code	Package	Packing
TDA7703	LQFP44 (10x10x1.4mm)	Tray
TDA7703TR	LQFP44 (10x10x1.4mm)	Tape and reel

# Contents

- 1      Block diagram and pin description ..... 6**
  - 1.1    Block diagram ..... 6
  - 1.2    Pin description ..... 7
  
- 2      Function description ..... 9**
  - 2.1    FM - mixer ..... 9
  - 2.2    FM - AGC ..... 9
  - 2.3    AM - LNA ..... 9
  - 2.4    AM - AGC ..... 9
  - 2.5    AM - mixer ..... 9
  - 2.6    IF A/D converters ..... 9
  - 2.7    Audio D/A converters ..... 10
  - 2.8    VCO ..... 10
  - 2.9    PLL ..... 10
  - 2.10   Crystal oscillator ..... 10
  - 2.11   DSP ..... 10
  - 2.12   IO interface pins ..... 11
  - 2.13   Serial interface ..... 11
  
- 3      Electrical specifications ..... 13**
  - 3.1    Absolute maximum ratings ..... 13
  - 3.2    Thermal data ..... 13
  - 3.3    General key parameters ..... 13
  - 3.4    Electrical characteristics ..... 14
    - 3.4.1    FM - section ..... 14
    - 3.4.2    AM - section ..... 15
    - 3.4.3    VCO ..... 15
    - 3.4.4    Phase locked loop ..... 16
    - 3.4.5    Audio DAC ..... 16
    - 3.4.6    IO interface pins ..... 16
    - 3.4.7    I<sup>2</sup>C interface ..... 17
  - 3.5    Overall system performance ..... 18

---

3.5.1	FM overall system performance	18
3.5.2	AM MW overall system performance	20
3.5.3	AM LW overall system performance	21
<b>4</b>	<b>Front-end processing</b>	<b>22</b>
<b>5</b>	<b>Weak signal processing</b>	<b>24</b>
5.1	FM IF-processing	24
5.1.1	Dynamic channel selection filter (DISS)	24
5.1.2	Soft mute	24
5.1.3	Adjacent channel mute	25
5.1.4	Stereo blend	25
5.1.5	High cut control	26
5.1.6	Stereo decoder	27
5.2	AM IF-processing	27
5.2.1	Channel selection filter	27
5.2.2	Soft mute	27
5.2.3	High cut control	28
<b>6</b>	<b>Application schematic</b>	<b>29</b>
<b>7</b>	<b>Package information</b>	<b>30</b>
<b>8</b>	<b>Revision history</b>	<b>31</b>

## List of tables

Table 1.	Device summary . . . . .	1
Table 2.	Pin description . . . . .	7
Table 3.	Absolute maximum ratings . . . . .	13
Table 4.	Thermal data . . . . .	13
Table 5.	General key parameters . . . . .	13
Table 6.	FM - section . . . . .	14
Table 7.	AM - section . . . . .	15
Table 8.	VCO . . . . .	15
Table 9.	Phase locked loop . . . . .	16
Table 10.	Audio DAC . . . . .	16
Table 11.	IO interface pins . . . . .	16
Table 12.	I <sup>2</sup> C interface . . . . .	17
Table 13.	FM overall system performance . . . . .	18
Table 14.	AM MW overall system performance . . . . .	20
Table 15.	AM LW overall system performance . . . . .	21
Table 16.	Register 0x00 . . . . .	22
Table 17.	Register 0x01 . . . . .	23
Table 18.	Register 0x02 . . . . .	23
Table 19.	Dynamic channel selection filter (DISS) . . . . .	24
Table 20.	Soft mute . . . . .	24
Table 21.	Adjacent channel mute . . . . .	25
Table 22.	Stereo blend . . . . .	25
Table 23.	High cut control . . . . .	26
Table 24.	De-emphasis filter . . . . .	27
Table 25.	Stereo decoder . . . . .	27
Table 26.	Channel selection filter . . . . .	27
Table 27.	Soft mute . . . . .	27
Table 28.	High cut control . . . . .	28
Table 29.	Document revision history . . . . .	31

## List of figures

Figure 1.	Functional block diagram . . . . .	6
Figure 2.	Pin connection (top view) . . . . .	7
Figure 3.	I <sup>2</sup> C "write" sequence . . . . .	11
Figure 4.	I <sup>2</sup> C "read" sequence . . . . .	12
Figure 5.	I <sup>2</sup> C bus timing diagram . . . . .	17
Figure 6.	FM input set-up . . . . .	18
Figure 7.	AM MW input set up . . . . .	20
Figure 8.	AM LW input set-up . . . . .	21
Figure 9.	Typical application schematic . . . . .	29
Figure 10.	LQFP44 (10x10x1.4mm) mechanical data and package dimensions. . . . .	30



## 1.2 Pin description

Figure 2. Pin connection (top view)

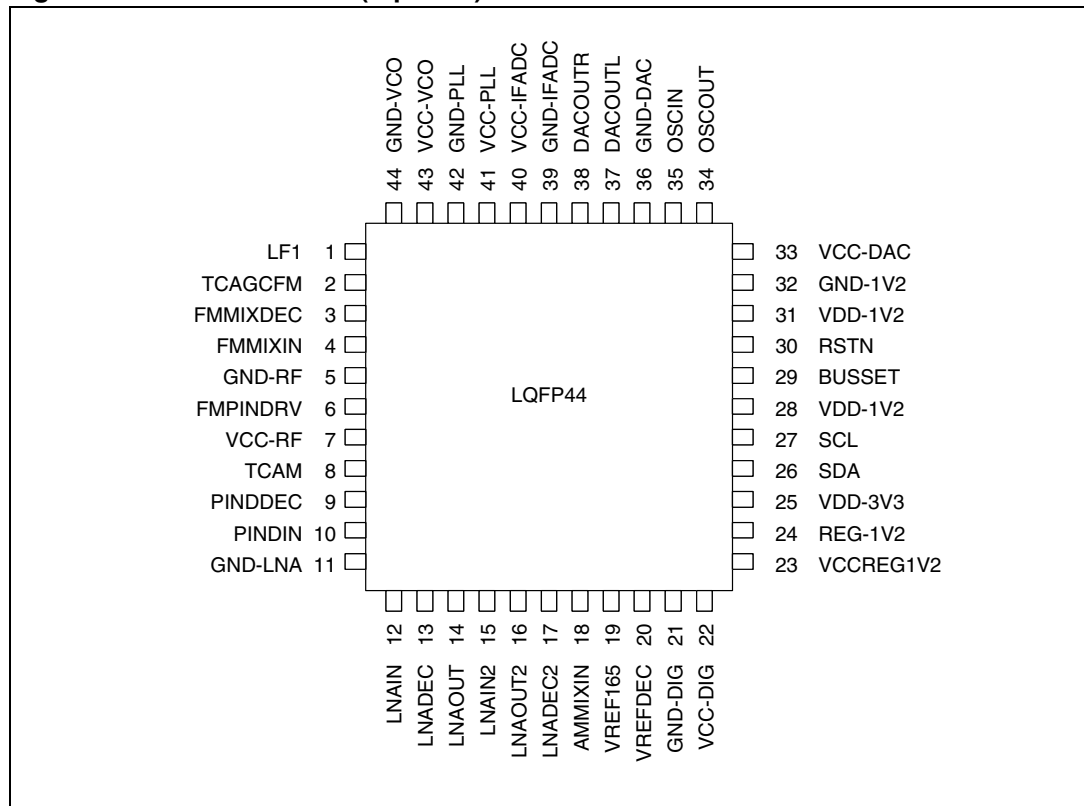

Table 2. Pin description

Pin #	Pin name	Description
1	LF1	PLL loopfilter output
2	TCAGCFM	FM AGC time constant
3	FMMIXDEC	FM mixer decoupling
4	FMIXIN	FM mixer input
5	GND-RF	RF Ground
6	FMPINDRV	FM AGC PIN diode driver
7	VCC-RF	5 V supply for RF section
8	TCAM	AM AGC time constant
9	PINDEDEC	AM AGC internal PIN diode decoupling
10	PINDIN	AM AGC internal PIN diode input
11	GND-LNA	GND of AM LNA, AM internal PIN diode , AM mixer, IF
12	LNAIN	AM LNA input
13	LNADEC	AM LNA decoupling
14	LNAOUT	AM LNA output first stage

**Table 2. Pin description (continued)**

Pin #	Pin name	Description
15	LNAIN2	AM LNA input 2 <sup>nd</sup> stage
16	LNAOUT2	AM LNA output
17	LNADEC2	AM LNA decoupling 2nd stage
18	AMMIXIN	AM mixer input
19	VREF165	1.65 V reference voltage decoupling
20	VREFDEC	3.3 V reference voltage decoupling
21	GND-DIG	Digital GND
22	VCC-DIG	5 V supply for digital logic
23	VCCREG1V2	VCC of 1.2 V regulator
24	REG1V2	1.2 V regulator output
25	VDD-3V3	3.3 V VDD output / decoupling
26	SDA	I <sup>2</sup> C bus data
27	SCL	I <sup>2</sup> C bus clock
28	VDD-1V2	1.2 V DSP supply
29	BUSSET	Bus communication setup
30	RSTN	Reset pin (active low)
31	VDD-1V2	1.2 V DSP supply
32	GND-1V2	Digital GND for 1.2 V VDD
33	VCC-DAC	5 V supply of audio DAC
34	OSCOUT	Xtal osc output
35	OSCIN	Xtal osc input
36	GND-DAC	Audio DAC GND
37	DACOUTL	Audio output left
38	DACOUTR	Audio output right
39	GND-IFADC	IF ADC GND
40	VCC-IFADC	5 V supply of IF ADC
41	VCC-PLL	5 V supply of PLL
42	GND-PLL	PLL GND
43	VCC-VCO	5 V supply of VCO
44	GND-VCO	VCO GND



## 2 Function description

### 2.1 FM - mixer

The FM image-rejection mixer is optimized for best performance with a passive wide-band prestage.

The input frequency is downconverted to low IF with high image rejection.

### 2.2 FM - AGC

The programmable RFAGC senses the mixer input whereas the IFAGC senses the IFADC input to avoid overload.

The PIN diode driver is able to drive external PIN diodes with a current value as high as 15mA.

The time constant of the FM-AGC is defined by an external capacitor.

### 2.3 AM - LNA

The AM-LNA is integrated with low noise and high IIP2 and IIP3. The gain of the LNA is controlled by the AGC. The maximum gain is set with an external resistor, typically 28 dB with 1.5 k $\Omega$ .

### 2.4 AM - AGC

The programmable AM-RF-AGC senses the mixer inputs and controls the internal PIN diode and LNA gain.

First the LNA gain is reduced by about 10dB, then the PIN diodes are activated to attenuate the signal.

The time constant of the AM-AGC is defined with an external capacitor and programmable internal currents.

### 2.5 AM - mixer

The AM mixer converts RF to low IF with high image rejection.

### 2.6 IF A/D converters

A high performance IQ-IFADC converts the IF-signal to digital IF for subsequent digital signal processing.

## 2.7 Audio D/A converters

A stereo DAC provides the left / right audio signals after IF-processing and stereodecoding by the DSP.

## 2.8 VCO

The VCO is fully integrated without any external tuning component. It covers all FM frequency bands including EU, US, Japan, EastEU and AM-bands including LW and MW.

## 2.9 PLL

The high speed tuning PLL is able to settle within about 300  $\mu$ s.

The frequency step can be as low as 5 kHz in FM and 500 Hz in AM.

## 2.10 Crystal oscillator

The device works with a 37.05 MHz fundamental tone crystal, and can be used also with a 3<sup>rd</sup> overtone 37.05 MHz crystal.

## 2.11 DSP

The DSP and its hardware accelerators perform all the digital signal processing. The main program is fixed in ROM. Control parameters are copied in RAM and are accessible and modifiable there, thus allowing parametric performance optimization.

It performs:

- digital down-conversion of IF
- bandwidth selection with variable controlled bandwidth
- FM noiseblanking
- FM/AM demodulation with softmute, high-cut, weak signal processing and quality detection
- FM stereo decoding with stereo blend

## 2.12 IO interface pins

The TDA7703 has the following IO pins:

SDA	pin 26	serial communication with $\mu$ P
SCL	pin 27	serial communication with $\mu$ P
BUSSET	pin 29	serial communication with $\mu$ P
RSTN	pin 30	reset pin driven by $\mu$ P

All the inputs are voltage-tolerant up to 3.5 V . The outputs can drive currents up to 0.5 mA from the internal 3.3 V supply line.

## 2.13 Serial interface

The device is controlled with a standard I<sup>2</sup>C bus interface.

Through the serial bus the processing parameters can be modified and the signal quality parameters can be read out.

The operation of the device is handled through high level commands sent by the main car-radio  $\mu$ P through the serial interface, which allow to simplify the operations carried out in the main  $\mu$ P. The high level commands include among others:

- set frequency (which allows to avoid computing the PLL divider factors);
- start seek (the seek operation can be carried out by the TDA7703 in a completely autonomous fashion).

The serial bus communication configuration is set by forcing pin 29 (BUSSET) to ground when the RSTN line transitions from low to high (when RSTN is low, the IC is in reset mode).

The voltage level forced to pin 29 must be released to start the system operation a suitable time after the RSTN line has gone high. The I<sup>2</sup>C address is 0xC2 (write) / 0xC3 (read).

The status of pin 29 during the reset phase can be set to low by not forcing any voltage on it from outside, as a 50 k $\Omega$  internal pull-down resistors is present.

To make sure the boot mode is correctly latched up at start-up, it is advisable to keep the RSTN line low until the IC supply pins have reached their steady state, and then for an additional time  $T_{reset}$  (see [Section 3.4.6](#)).

I<sup>2</sup>C requires two signals: clock (SCL) and data (SDA - bidirectional). The protocol requires an acknowledge after any 8-bit transmission.

A "write" communication example is shown in the figure below, for an unspecified number of data bytes (see Communication Protocol Manual for frame structure description):

**Figure 3. I<sup>2</sup>C "write" sequence**

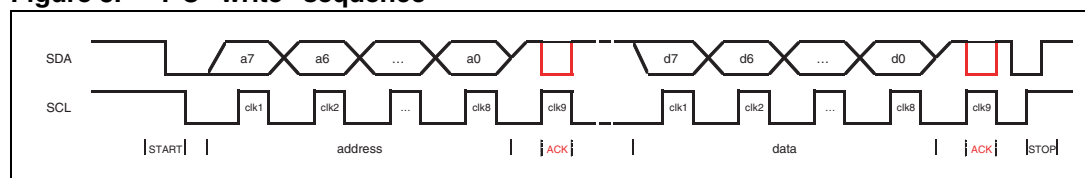

The sequence consists of the following phases:

- **START:** SDA line transitioning from H to L with SCL fixed H. This signifies a new transmission is starting;
- **data latching:** on the rising SCL edge. The SDA line can transition only when SCL is low (otherwise its transitions are interpreted as either a START or a STOP transition);
- **ACKnowledge:** on the 9<sup>th</sup> SCL pulse the  $\mu$ P keeps the SDA line H, and the TDA7703 pulls it down if communication has been successful. Lack of the acknowledge pulse generation from the TDA7703 means that the communication has failed;
- a chip address byte must be sent at the beginning of the transmission. The value is C2 for "write";
- as many data bytes as needed can follow the address before the communication is terminated. See the next section for details on the frame format;
- **STOP:** SDA line transitioning from L to H with SCL H. This signifies the end of the transmission.

Red lines represent transmissions from the TDA7703 to the  $\mu$ P.

A "read" communication example is shown in the figure below, for an unspecified number of data bytes (see later on for frame structure description):

**Figure 4. I<sup>2</sup>C "read" sequence**

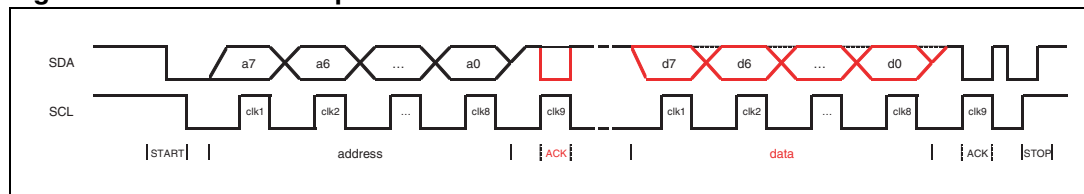

The sequence is very similar to the "write" one and has the same constraints for start, stop, data latching. The differences follow:

- a chip address must always be sent by the  $\mu$ P to the TDA7703; the address must be C3;
- a header is transmitted after the chip address (the same happens for "write") before data are transferred from the TDA7703 to the  $\mu$ P. See the Communication Protocol Manual for details on the frame format;
- when data are transmitted from the TDA7703 to the  $\mu$ P, the  $\mu$ P keeps the SDA line H;
- the ACKnowledge pulse is generated by the  $\mu$ P for those data bytes that are sent by the TDA7703 to the  $\mu$ P. Failure of the  $\mu$ P to generate an ACK pulse on the 9<sup>th</sup> CLK pulse has the same effect on the TDA7703 as a STOP.

The max. clock speed is 500 kbit/s.

## 3 Electrical specifications

### 3.1 Absolute maximum ratings

Table 3. Absolute maximum ratings

Symbol	Parameter	Test condition	Min	Typ	Max	Units
$V_{CC}$	Supply voltage				5.5	V
$T_{stg}$	Storage temperature		-55		150	°C

### 3.2 Thermal data

Table 4. Thermal data

Symbol	Parameter	Test condition	Value	Units
$R_{Th\ j-case}$	Thermal resistance junction to case	LQFP44 10x10, double-layer JEDEC PCB	55	°C/W

### 3.3 General key parameters

Table 5. General key parameters

Symbol	Parameter	Test condition	Min	Typ	Max	Units
$V_{CC}$	5 V supply voltage		4.7	5	5.25	V
$I_{CC}$	Supply current @ 5 V			220	295	mA
$T_{amb}$	Ambient temperature range		-30		75	°C
$V_{VCCREG12}$	VCCREG12 supply voltage	see note <sup>(1)</sup>	2			V
$V_{1V2}$	Digital core 1.2V supply voltage	when supplied externally see note <sup>(2)</sup>	1.08	1.2	1.32	V
$I_{1V2}$	Digital core 1.2 V supply current	$V_{1V2} = 1.08\text{ V}$ see note <sup>(2)</sup>			120	mA
		$V_{1V2} = 1.2\text{ V}$ see note <sup>(2)</sup>		80	135	mA
		$V_{1V2} = 1.32\text{ V}$ see note <sup>(2)</sup>			150	mA

1. In the typical application supplied from 5V with a series resistor.

2. When the 1.2 V supply is applied externally, and not using the internal 1.2 V regulator.

### 3.4 Electrical characteristics

$V_{CC} = 5\text{ V}$ ;  $T_{amb} = 27\text{ °C}$ ; unless otherwise specified.

#### 3.4.1 FM - section

Table 6. FM - section

Symbol	Parameter	Test condition	Min	Typ	Max	Units
<b>FM IMR mixer</b>						
$R_{in}$	Input resistance		90	130	170	$k\Omega$
IIP3	3 <sup>rd</sup> order intercept point	up to $V_{in/tone} = 85\text{ dB}\mu\text{V}$		121		$\text{dB}\mu\text{V}$
<b>FM AGC</b>						
RFAGC-Thr	RFAGC threshold, referred to mixer input; RF level	min setting		85		$\text{dB}\mu\text{V}$
		max setting		91		
	Threshold steps		2		$\text{dB}$	
	Threshold error		-1.5		1.5	$\text{dB}$
	Threshold temperature drift			0.016		$\text{dB/K}$
IFAGC-Thr	IFAGC threshold, referred to mixer input; at tuned frequency RF level	min setting		77		$\text{dB}\mu\text{V}$
		max setting		81		
	Threshold steps		2		$\text{dB}$	
	Threshold error		-1.5		1.5	$\text{dB}$
	Threshold temperature drift			0.016		$\text{dB/K}$
	Pin diode source current	see note <sup>(1)</sup>	12			$\text{mA}$
	Pin diode sink current		3		20	$\mu\text{A}$
	Pin diode source current in constant current mode	see note <sup>(1)</sup>	0.4			$\text{mA}$

1. The current is generated by a PTAT (Proportional To Absolute Temperature) source, and has therefore a temperature dependency described by:  $\Delta I/I_0 = \Delta T/T_0$ , with  $I_0$  being the current at ambient temperature ( $25\text{ °C}$ ) and  $T_0$  the ambient temperature ( $25\text{ °C}$ ) expressed in Kelvin, that is 298 K.

### 3.4.2 AM - section

Table 7. AM - section

Symbol	Parameter	Test condition	Min	Typ	Max	Units
<b>AM IMR Mixer</b>						
$R_{in}$	Input resistance		20	30	45	$k\Omega$
IIP3	3 <sup>rd</sup> order intercept point	up to $V_{in/tone} = 90 \text{ dB}\mu\text{V}$		129		$\text{dB}\mu\text{V}$
IIP2	2 <sup>nd</sup> order intercept point	up to $V_{in/tone} = 90 \text{ dB}\mu\text{V}$		158		$\text{dB}\mu\text{V}$
LO hsupp	LO harmonic suppression	N=2,3,4,5,6		100		dB
		N=7,9		85		
<b>AM LNA</b>						
Gain	Voltage gain	Max Gain, $R_{ext} = 1.5 \text{ k}\Omega$	24	28	31	dB
		Min Gain (AGC controlled)		12		
$R_{in}$	Input resistance			1000		$k\Omega$
$C_{in}$	Input capacitance			20		pF
IIP3	3 <sup>rd</sup> order intercept point	@ maximum LNA gain		125		$\text{dB}\mu\text{V}$
IIP2	2 <sup>nd</sup> order intercept point	@ maximum LNA gain		143		$\text{dB}\mu\text{V}$
<b>AM PIN diode</b>						
IIP2	2 <sup>nd</sup> order intercept point	Full attenuation, $C_{source} = 80 \text{ pF}$ , $f=1 \text{ MHz}$		140		$\text{dB}\mu\text{V}$
$R_{min}$	Minimum resistance			50	80	$\Omega$
$C_{in}$	Input capacitance	High ohmic		12		pF
<b>AM AGC</b>						
AGC-Thr	Referred to mixer input RF level	min setting		87		$\text{dB}\mu\text{V}$
		max setting		93		
Thr-steps	Threshold steps			1		dB
	Threshold error		-2.5		2.5	
	Threshold temperature drift		-3		3	

### 3.4.3 VCO

Table 8. VCO

Symbol	Parameter	Test condition	Min	Typ	Max	Units
$F_{VCO}$	Frequency range VCO		1100		1550	MHz
PN	Phase noise of LO	Locked VCO; values referred @ 100MHz @ 100 Hz @ 1 kHz @ 10 kHz		-100 -115 -115		$\text{dBc}/\text{Hz}$
dev	Deviation error (rms)	FM reception, deemphasis $50\mu\text{s}$ , $f_{audio}=20\text{Hz}...20\text{kHz}$		5		Hz

### 3.4.4 Phase locked loop

Table 9. Phase locked loop

Symbol	Parameter	Test condition	Min	Typ	Max	Units
$T_{\text{settle}}$	Settling time FM	$\Delta f < 10$ kHz		300		$\mu\text{s}$
FM step	FM frequency step			5		kHz
AM step	AM frequency step			500		Hz

### 3.4.5 Audio DAC

Table 10. Audio DAC

Symbol	Parameter	Test condition	Min	Typ	Max	Units
$V_{\text{out}}$	Output voltage	AM 90% modulation; FM 75 kHz deviation. 400 Hz audio frequency		300		mVrms
BW	Bandwidth	1 dB attenuation		15		KHz
$R_{\text{out}}$	Output resistance		600	750	900	$\Omega$

### 3.4.6 IO interface pins

Table 11. IO interface pins

Symbol	Parameter	Test condition	Min	Typ	Max	Units
	High level output voltage	$I_{\text{out}} = 500\mu\text{A}$	2.9	3.2		V
	Low level output voltage	$I_{\text{out}} = -1\text{mA}$		0.1	0.3	V
	Input voltage range		0		3.5	V
	High level input voltage		2.0			V
	Low level input voltage				0.8	V
$T_{\text{reset}}$	Reset time	Minimum time during which pin RSTN must be low so as to reset the device	10			$\mu\text{s}$
$T_{\text{latch}}$	Boot mode configuration latch time	Minimum time during which the voltage applied at pin 29 must be kept in order to latch the correct boot mode (serial bus configuration)	10			$\mu\text{s}$



### 3.4.7 I<sup>2</sup>C interface

The parameters of the following table are defined as in [Figure 5](#).

**Table 12. I<sup>2</sup>C interface**

Symbol	Parameter	Test condition	Min	Typ	Max	Units
f <sub>SCL</sub>	SCL Clock frequency				500	kHz
t <sub>AA</sub>	SCL low to SDA data valid		0.3			μs
t <sub>buf</sub>	time the bus must be kept free before a new transmissison		1.3			μs
t <sub>HD-STA</sub>	START condition hold time		0.6			μs
t <sub>LOW</sub>	Clock low period		1.3			μs
t <sub>HIGH</sub>	Clock high period		0.6			μs
t <sub>SU-SDA</sub>	START condition setup time		0.1			μs
t <sub>HD-DAT</sub>	Data input hold time		0.3		0.9	μs
t <sub>SU-DAT</sub>	Data input setup time		0.1			μs
t <sub>R</sub>	SDA & SCL rise time				0.3	μs
t <sub>F</sub>	SDA & SCL fall time				0.3	μs
t <sub>SU-STOP</sub>	Stop condition setup time		0.6			μs
t <sub>DH</sub>	Data out time				0.3	μs

**Figure 5. I<sup>2</sup>C bus timing diagram**

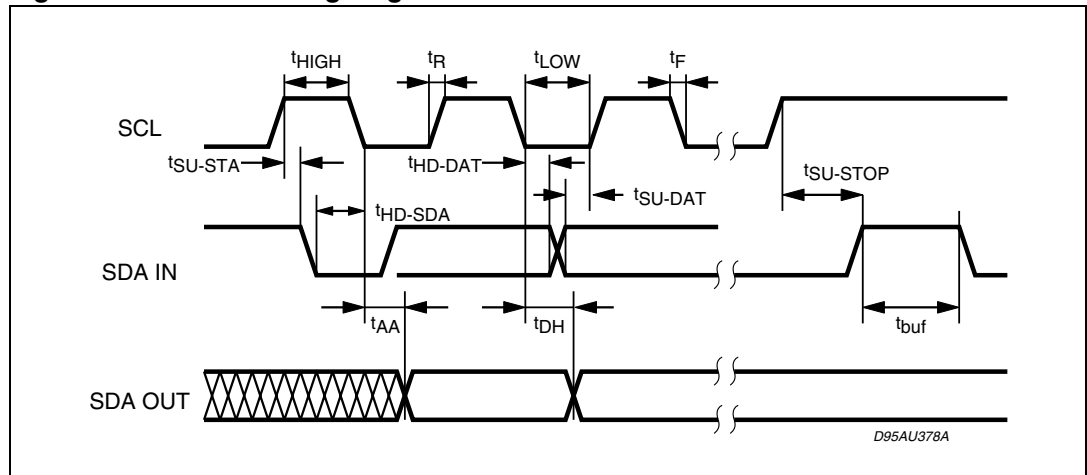

### 3.5 Overall system performance

All measurements obtained with application of *Figure 9* unless otherwise specified.

#### 3.5.1 FM overall system performance

Antenna level equivalence:  $0 \text{ dB}\mu\text{V} = 1 \text{ }\mu\text{V}_{\text{rms}}$  (Antenna terminal voltage with  $50 \text{ }\Omega$  source).

**Figure 6. FM input set-up**

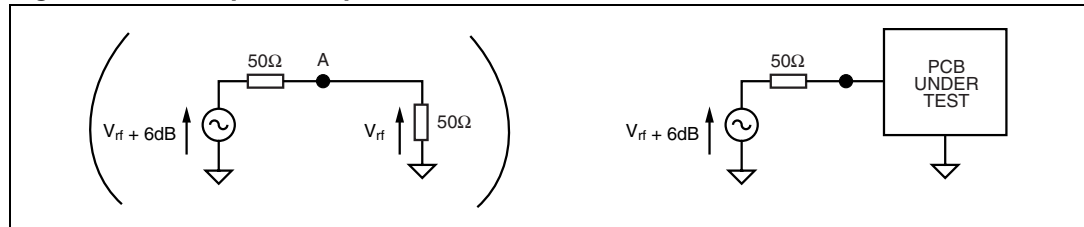

Input level referred to signal generator loaded with  $50 \text{ }\Omega$  ( $V_{\text{rf}}$ , node 'A'); no antenna dummy; AM input not connected.  $F_{\text{rf}} = 98.1 \text{ MHz}$ ,  $V_{\text{rf}} = 60 \text{ dB}\mu\text{V}$ , mono modulation,  $f_{\text{dev}} = 40 \text{ kHz}$ ,  $f_{\text{audio}} = 1 \text{ kHz}$ . De-emphasis =  $50 \text{ }\mu\text{s}$ . Unless otherwise specified

**Table 13. FM overall system performance**

Parameter	Test condition	Min	Typ	Max	Units
Tuning range FM Eu	(can be modified by the user)	87.5		108	MHz
Tuning step FM Eu			100		kHz
Tuning range FM US		87.5		107.9	MHz
Tuning step FM US			200		kHz
Tuning range FM Jp		76		90	MHz
Tuning step FM Jp			100		kHz
Tuning range FM EEu		65		74	MHz
Tuning step FM EEu			100		kHz
Sensitivity	S/N =26dB		-3	0	$\text{dB}\mu\text{V}$
Ultimate S/N	@ $60 \text{ dB}\mu\text{V}$ , mono	72	75		dB
	@ $60 \text{ dB}\mu\text{V}$ , Deviation = $75 \text{ kHz}$ , mono	77	80		dB
	@ $60 \text{ dB}\mu\text{V}$ , stereo	70	73		dB
Distortion	Deviation= $75 \text{ kHz}$		0.15		%
Max deviation	THD=3%	120			kHz
Adjacent channel selectivity ( $V_u/V_d$ )	$\Delta F=100 \text{ kHz}$ , SINAD=30 dB desired $40 \text{ dB}\mu\text{V}$ , dev= $40 \text{ kHz}$ , 400Hz undesired. dev= $40 \text{ kHz}$ , $1 \text{ kHz}$		13		dB
Alternate channel selectivity ( $V_u/V_d$ )	$\Delta F=200 \text{ kHz}$ , SINAD=30 dB desired $40 \text{ dB}\mu\text{V}$ , dev= $40 \text{ kHz}$ , $400 \text{ Hz}$ undesired. dev= $40 \text{ kHz}$ , $1 \text{ kHz}$		62		dB

Table 13. FM overall system performance (continued)

Parameter	Test condition	Min	Typ	Max	Units
Max. strong signal interferer ( $V_u/V_d$ )	Desired = 40 dB $\mu$ V SINAD = 30dB Undesired $\Delta F$ = 5MHz dev = 40kHz, 1kHz		75		dB
3 signal performance ( $V_{u1}$ & $V_{u2}/V_d$ ) <sup>(1)</sup>	Desired = 40 dB $\mu$ V, dev=40kHz, 400Hz, SINAD=30dB Undesired1 = $\pm$ 400kHz, dev=40kHz, 1 kHz Undesired2= $\pm$ 800kHz, no mod		62		dB
	Desired = 40 dB $\mu$ V, dev=40kHz, 400Hz, SINAD=30dB Undesired1 = $\pm$ 1MHz, dev=40kHz, 1 kHz Undesired2= $\pm$ 2MHz, no mod		65		dB
AM suppression	m=30%		70		dB
Image rejection			80		dB
Logarithmic field strength indicator	@40 dB $\mu$ V read "FM_Smeter_log"	-0.33 (equiv. to 37 dB $\mu$ V)	-0.3	-0.27 (equiv. to 43 dB $\mu$ V)	-

1. Signal levels referred to combiner output.

### 3.5.2 AM MW overall system performance

Antenna level equivalence:  $0 \text{ dB}\mu\text{V} = 1 \mu\text{V}_{\text{rms}}$ .

**Figure 7. AM MW input set up**

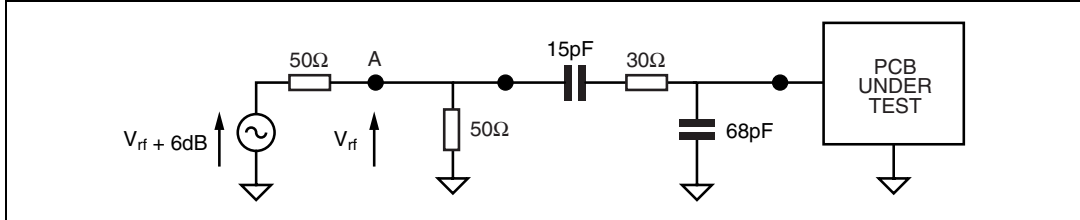

Level referred to SG output before antenna dummy ( $V_{rf}$ , node 'A'); capacitive dummy 15pF+68pF, FM input not connected.  $F_{rf} = 999 \text{ kHz}$  (1000 kHz for US),  $V_{rf} = 74 \text{ dB}\mu\text{V}$ ,  $\text{mod} = 30\%$ ,  $f_{\text{audio}} = 400 \text{ Hz}$ , unless otherwise specified.

**Table 14. AM MW overall system performance**

Parameter	Test condition	Min	Typ	Max	Units
Tuning range MW Eu/Jp	(can be modified by the user)	531		1629	kHz
Tuning step MW Eu/Jp	(can be modified by the user)		9		kHz
Tuning range MW US	(can be modified by the user)	530		1710	kHz
Tuning step MW US	(can be modified by the user)		10		kHz
Sensitivity	S/N = 20 dB		29	32	$\text{dB}\mu\text{V}$
Ultimate S/N	@ 80 $\text{dB}\mu\text{V}$	63	66		dB
AGC F.O.M.	Ref.=74 $\text{dB}\mu\text{V}$ -10dB drop point	50	62	65	dB
Distortion	$m = 80 \%$		0.1		%
Adjacent channel selectivity	$\Delta F = 9 \text{ kHz}$ , $V_{\text{audio}} = -10 \text{ dB}$ (relative to $\Delta F = 0 \text{ kHz}$ ), $m = 30\%$ , 1 kHz		97		dB
Alternate channel selectivity	$\Delta F = 18 \text{ kHz}$ , $V_{\text{audio}} = -10 \text{ dB}$ (relative to $\Delta F = 0 \text{ kHz}$ ), $m = 30\%$ , 1 kHz		97		dB
Image rejection			80		dB
Logarithmic field strength indicator	@60 $\text{dB}\mu\text{V}$ read "AM_Smeter_log"	0.50 (equiv. to 57 $\text{dB}\mu\text{V}$ )	0.47	0.43 (equiv. to 63 $\text{dB}\mu\text{V}$ )	-

### 3.5.3 AM LW overall system performance

Antenna level equivalence:  $0\text{dB}\mu\text{V} = 1\mu\text{V}_{\text{rms}}$

**Figure 8. AM LW input set-up**

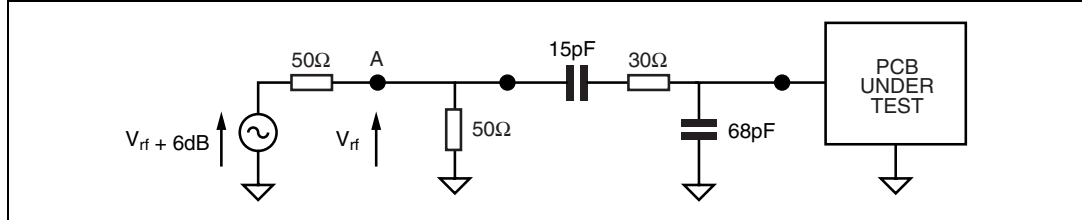

Level referred to SG output before antenna dummy ( $V_{\text{rf}}$ , node 'A'); capacitive dummy 15pF+68pF; FM input not connected.  $F_{\text{rf}} = 216\text{ kHz}$ ,  $V_{\text{rf}} = 74\text{ dB}\mu\text{V}$ , mod = 30 %,  $f_{\text{audio}} = 400\text{ Hz}$ , unless otherwise specified.

**Table 15. AM LW overall system performance**

Parameter	Test condition	Min	Typ	Max	Units
Tuning range LW	(can be modified by the user)	144		288	kHz
Tuning step LW	(can be modified by the user)		1		kHz
Sensitivity	S/N =20dB		31	34	dB $\mu\text{V}$
Ultimate S/N	@ 80 dB $\mu\text{V}$	63	66		dB
AGC F.O.M.	Ref.=74 dB $\mu\text{V}$ -10dB drop point	50	62	65	dB
Distortion	m = 80 %		0.1		%
Image rejection			80		dB

## 4 Front-end processing

All the parameters in this section refer to the programmability of the FE part of the device (registers). The part of the registers that are not described here have either fixed values or values written by the tuner drivers, and are described in the proper technical documentation (Communication Protocol manual).

**Table 16. Register 0x00**

Register number																				Register definition					
MSB																			LSB						
23	22	21	20	19	18	17	16	15	14	13	12	11	10	9	8	7	6	5	4		3	2	1	0	
																									<b>AM AGC mode</b>
										0															LNA and PIN diode
										1															PIN diode only
																									<b>AM AGC time constant</b>
								0	0																slow (125 ms with 1 $\mu$ F)
								0	1																medium (25 ms with 1 $\mu$ F)
								1	1																fast (5 ms with 1 $\mu$ F)
																									<b>AM AGC threshold @ mixin</b>
					0	0	0																		90 dB $\mu$ V
					0	0	1																		91 dB $\mu$ V
					0	1	0																		92 dB $\mu$ V
					0	1	1																		93 dB $\mu$ V
					1	0	0																		90 dB $\mu$ V
					1	0	1																		89 dB $\mu$ V
					1	1	0																		88 dB $\mu$ V
					1	1	1																		87 dB $\mu$ V
																									<b>AM AGC attack time constant</b>
			0																						normal
			1																						fast

Table 17. Register 0x01

Register number																								Register definition
MSB																							LSB	
23	22	21	20	19	18	17	16	15	14	13	12	11	10	9	8	7	6	5	4	3	2	1	0	
																								FM mixer gain
								0																high
								1																low
																								FM AGC time constant
			0																					normal
			1																					fast
																								FM AGC output mode
0	0																							normal
0	1																							constant 15 mA
1	0																							constant 1 mA

Table 18. Register 0x02

Register number																								Register definition
MSB																							LSB	
23	22	21	20	19	18	17	16	15	14	13	12	11	10	9	8	7	6	5	4	3	2	1	0	
																								FM RF AGC threshold @ mixin
																						0	0	87 dB $\mu$ V
																						0	1	89 dB $\mu$ V
																						1	0	91 dB $\mu$ V
																						1	1	93 dB $\mu$ V
																								FM iF AGC threshold @ IFADC in
																						0	0	120 dB $\mu$ V
																						0	1	122 dB $\mu$ V
																						1	0	124 dB $\mu$ V

## 5 Weak signal processing

All the parameters in this section refer to the programmability of the DSP part of the device. The typical values are those set by default parameters (start-up without parametric change from main  $\mu$ P); the max and the min values refer to the programmability range. The values are referred to the typical application. Wherever the possible values are a discrete set, all the possible programmable values are displayed.

### 5.1 FM IF-processing

#### 5.1.1 Dynamic channel selection filter (DISS)

**Table 19. Dynamic channel selection filter (DISS)**  
(discrete set)

Symbol	Parameter	Test condition	Min	Typ	Max	Units
DISS BW	IF filter #2	response: - 3dB	-	$\pm 80$	-	kHz
	IF filter #1		-	$\pm 60$	-	kHz
	IF filter #0		-	$\pm 40$	-	kHz

#### 5.1.2 Soft mute

**Table 20. Soft mute**  
(continuous set)

Symbol	Parameter	Test condition	Min	Typ	Max	Units
SMsp	Start point vs. field strength	audio atten = 1 dB read "FM_softmute" no adjacent channel present	0	6	20	dB $\mu$ V
SMep	End point vs. field strength	audio atten = SMD + 1 dB read "FM_softmute" no adjacent channel present	-6	-6	10	dB $\mu$ V
SMd	Depth		-30	-15	0	dB
SMtauatt	Field strength LPF cut-off frequency for soft mute activation		0.1	100	4000	Hz
SMtaurel	Field strength LPF cut-off frequency for soft mute release		0.1	1	4000	Hz



### 5.1.3 Adjacent channel mute

**Table 21. Adjacent channel mute**  
(continuous set)

Symbol	Parameter	Test condition	Min	Typ	Max	Units
ACMd	Depth		SMd	0	0	dB

### 5.1.4 Stereo blend

**Table 22. Stereo blend**  
(continuous set)

Symbol	Parameter	Test condition	Min	Typ	Max	Units
MaxSep	Maximum stereo separation	field strength = 80 dB $\mu$ V, pilot deviation = 6.75 kHz	0	40	50	dB
SBFSp	Start point vs. field strength	separation = MaxSep - 1 dB no multipath present	20	50	60	dB $\mu$ V
SBFSep	End point vs. field strength	separation = 1 dB no multipath present	20	30	60	dB $\mu$ V
SBFStM2S	Field strength-related transition time from mono to stereo	$V_{rf}$ step-like variation from 20 dB $\mu$ V to 80 dB $\mu$ V	0.001	3	20	s
SBFStS2M	Field strength-related transition time from stereo to mono	$V_{rf}$ step-like variation from 80 dB $\mu$ V to 20 dB $\mu$ V	0.001	0.5	20	s
SBMPsp	Start point vs. multipath	separation = MaxSep - 1 dB equivalent 19 kHz AM modulation depth; field strength = 80 dB $\mu$ V	5	10	80	%
SBMPep	End point vs. multipath	separation = 1 dB equivalent 19 kHz AM modulation depth; field strength = 80 dB $\mu$ V	5	30	80	%
SBMPtM2S	Multipath -related transition time from mono to stereo	$V_{rf}$ step-like variation from 20 dB $\mu$ V to 80 dB $\mu$ V	0.001	1	20	s
SBMPtS2M	Multipath -related transition time from stereo to mono	$V_{rf}$ step-like variation from 80 dB $\mu$ V to 20 dB $\mu$ V	0.001	0.001	20	s
Pil ThrM2S	Pilot detector stereo threshold	Threshold on pilot tone deviation for mono-stereo transition	0.8	2.74	7	kHz
Pil ThrHyst	Pilot detector threshold hysteresis	Difference in pil. det. deviation threshold for stereo to mono transition compared to PilThrM2S	-	0.01	-	kHz

### 5.1.5 High cut control

**Table 23. High cut control**  
(continuous set)

Symbol	Parameter	Test condition	Min	Typ	Max	Units
HCFSsp	Start point vs. field strength	minimum RF level for widest HC filter (filter # 7) no multipath present	0	50	50	dB $\mu$ V
HCFSep	End point vs. field strength	maximum RF level for narrowest HC filter (filter # 0) no multipath present	0	30	40	dB $\mu$ V
HCFS <sub>t</sub> W2N	Field strength-related transition time from wide to narrow band	$V_{rf}$ step-like variation from 60 dB $\mu$ V to 10 dB $\mu$ V	(1)			-
HCFS <sub>t</sub> N2W	Field strength-related transition time from narrow to wide band	$V_{rf}$ step-like variation from 0 dB $\mu$ V to 60 dB $\mu$ V	(1)	14	100	s
HCMPsp	Start point vs. multipath	minimum RF level for widest HC filter (filter # 7) equivalent 19 kHz AM modulation depth; field strength = 80 dB $\mu$ V	5	10	150 <sup>(2)</sup>	%
HCMPep	End point vs. multipath	maximum RF level for narrowest HC filter (filter # 0) equivalent 19 kHz AM modulation depth; field strength = 80 dB $\mu$ V	5	30	150 <sup>(2)</sup>	%
HCMP <sub>t</sub> N2W	Multipath -related transition time from narrow to wide band	$V_{rf}$ step-like variation from 20 dB $\mu$ V to 80 dB $\mu$ V	0.001	0.001	20	s
HCMP <sub>t</sub> W2N	Multipath -related transition time from wide to narrow	$V_{rf}$ step-like variation from 80 dB $\mu$ V to 20 dB $\mu$ V	0.001	0.001	20	s
HCmaxBW	Maximum cut-off frequency of high cut filter bank	Filter #7, -3 dB response frequency, input signal with pre-emphasis	HCmin BW	14	18	kHz
HCminBW	Minimum cut-off frequency of high cut filter bank	Filter #0, -3 dB response frequency, input signal with pre-emphasis	0.1	3	HCmaxBW	kHz
HCnumFilt	Number of discrete HC filters	-	-	8 <sup>(3)</sup>	-	-

1. Depends only on field strength filter time constant.

2. Means that 100% equivalent 19 kHz AM modulation depth will not achieve full band narrowing.

3. Intermediate filters (#6 - #1) cut-off frequencies exponentially spaced between HCmaxBW and HCminBW.

**Table 24. De-emphasis filter**  
(continuous set)

Symbol	Parameter	Test condition	Min	Typ	Max	Units
DEtc	De-emphasis time constant 1		-	50	-	µs
	De-emphasis time constant 2		-	75	-	

### 5.1.6 Stereo decoder

**Table 25. Stereo decoder**

Symbol	Parameter	Test condition	Min	Typ	Max	Units
PilSup	Pilot signal suppression	Pilot 9%, 19 kHz, ref=40 kHz	-	60	-	dB
SubcSup	Subcarrier suppression	f = 38 kHz	-	70	-	dB
		f = 57 kHz	-	70	-	dB
		f = 76 kHz	-	80	-	dB

## 5.2 AM IF-processing

### 5.2.1 Channel selection filter

**Table 26. Channel selection filter**

Symbol	Parameter	Test condition	Min	Typ	Max	Units
CSF BW	Channel selection filter BW	response: - 3dB	-	±3.7	-	kHz

### 5.2.2 Soft mute

**Table 27. Soft mute**  
(continuous set)

Symbol	Parameter	Test condition	Min	Typ	Max	Units
SMsp	Start point vs. field strength	audio atten = 1 dB read "FM_softmute" no adjacent channel present	0	25	40	dBµV
SMep	End point vs. field strength	audio atten = SMD + 1 dB read "FM_softmute" no adjacent channel present	0	0	30	dBµV
SMD	Depth		-40	-24	0	dB
SMtauatt	Transition time for field strength-dependent soft mute activation		0.001	0.1	10	s
SMtaurel	Transition time for field strength-dependent soft mute release		0.001	3	10	s

### 5.2.3 High cut control

**Table 28. High cut control**  
(continuous set)

Symbol	Parameter	Test condition	Min	Typ	Max	Units
HCFSsp	Start point vs. field strength	minimum RF level for widest HC filter (filter # 7) no multipath present	0	40	50	dB $\mu$ V
HCFSep	End point vs. field strength	maximum RF level for narrowest HC filter (filter # 0) no multipath present	0	30	50	dB $\mu$ V
HCFSstW2N	Field strength-related transition time from wide to narrow band	$V_{rf}$ step-like variation from 60 dB $\mu$ V to 10 dB $\mu$ V	0.001	0.2	20	s
HCFSstN2W	Field strength-related transition time from narrow to wide band	$V_{rf}$ step-like variation from 0 dB $\mu$ V to 60 dB $\mu$ V	0.001	10	20	s
HCnumFilt	Number of discrete HC filters		-	8	-	-

# 6 Application schematic

Figure 9. Typical application schematic

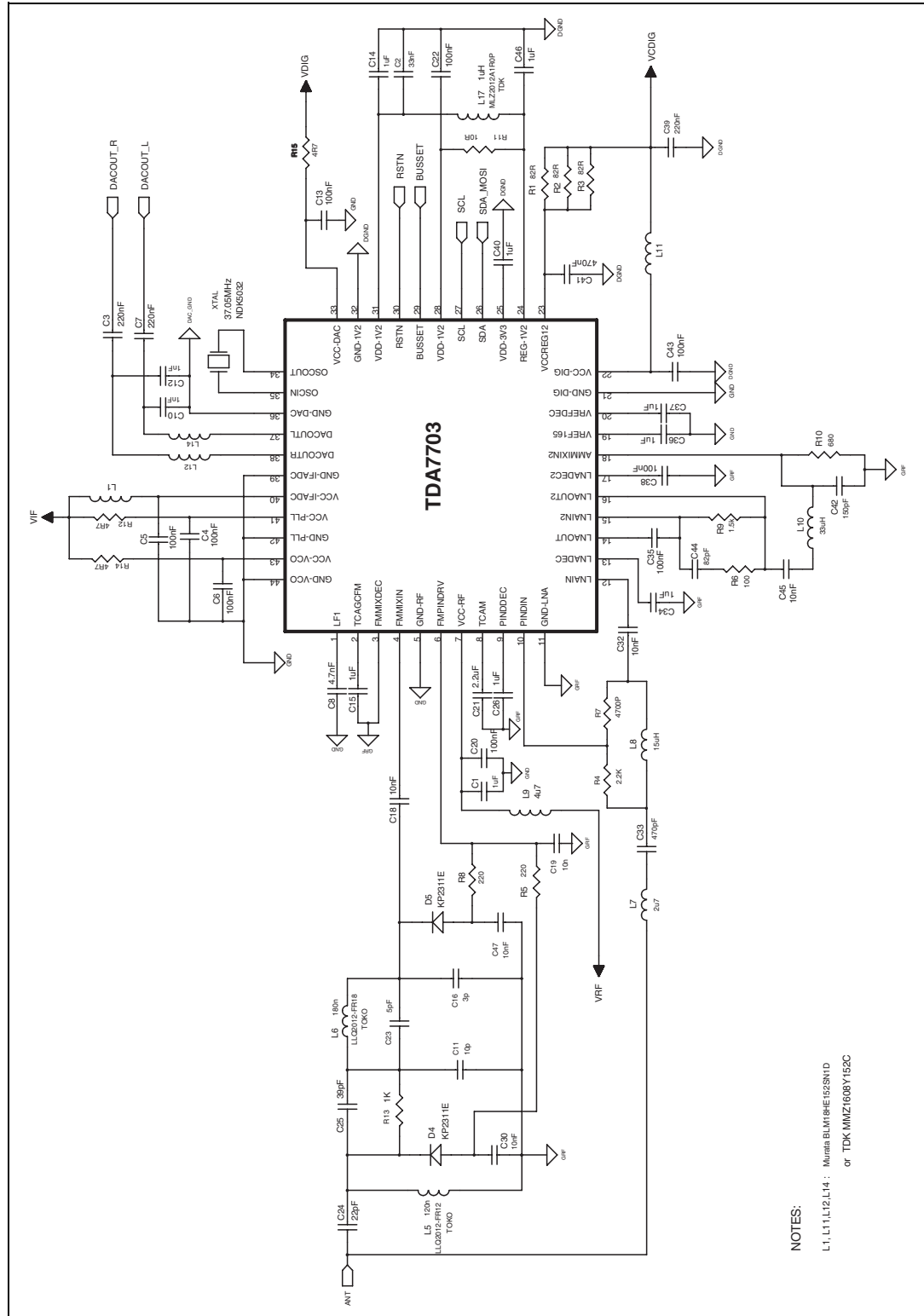

# 7 Package information

In order to meet environmental requirements, ST offers these devices in different grades of ECOPACK<sup>®</sup> packages, depending on their level of environmental compliance. ECOPACK<sup>®</sup> specifications, grade definitions and product status are available at: [www.st.com](http://www.st.com).

ECOPACK<sup>®</sup> is an ST trademark.

**Figure 10. LQFP44 (10x10x1.4mm) mechanical data and package dimensions**

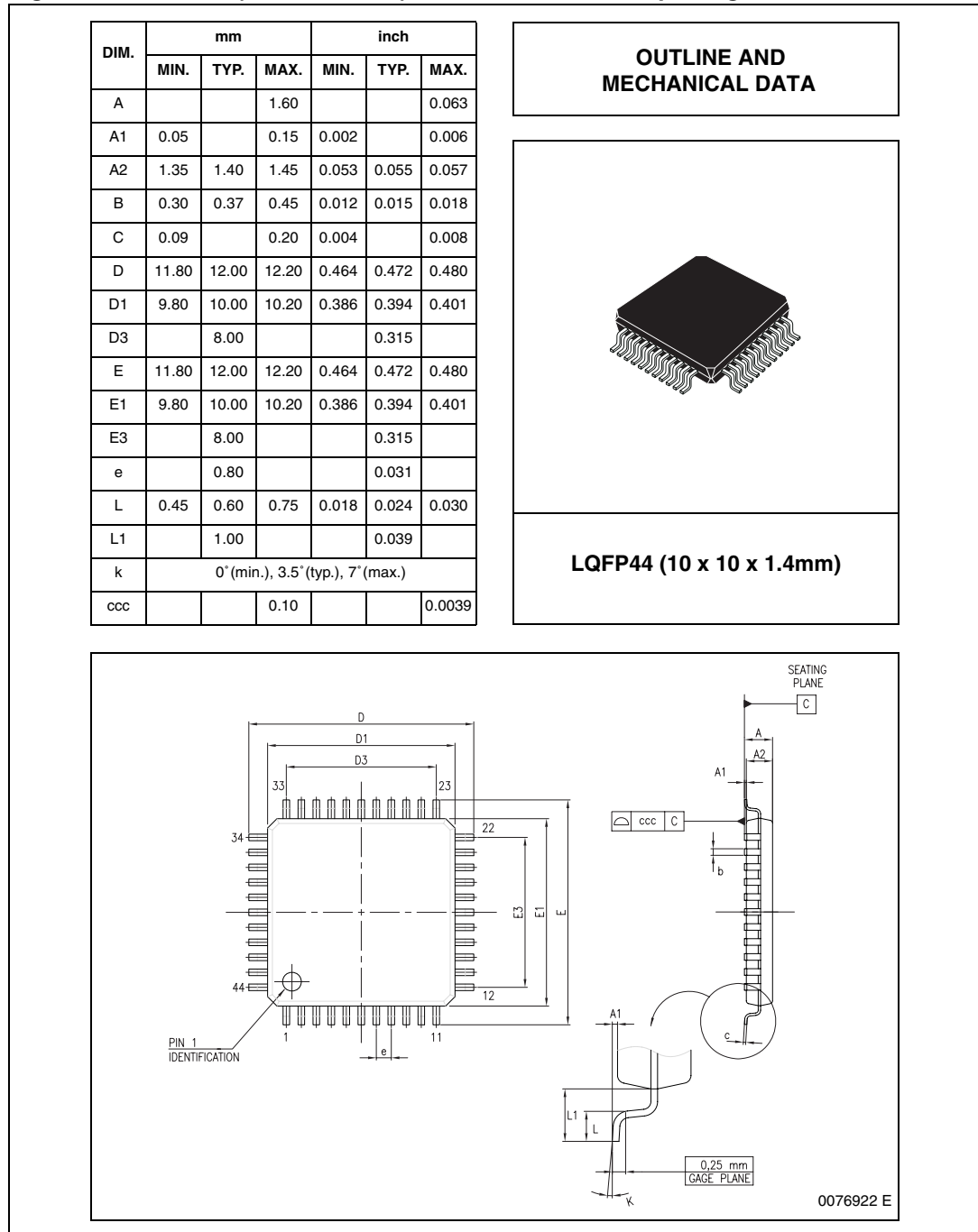

## 8 Revision history

**Table 29. Document revision history**

Date	Revision	Changes
24-Apr-2009	1	Initial release.

**Please Read Carefully:**

Information in this document is provided solely in connection with ST products. STMicroelectronics NV and its subsidiaries ("ST") reserve the right to make changes, corrections, modifications or improvements, to this document, and the products and services described herein at any time, without notice.

All ST products are sold pursuant to ST's terms and conditions of sale.

Purchasers are solely responsible for the choice, selection and use of the ST products and services described herein, and ST assumes no liability whatsoever relating to the choice, selection or use of the ST products and services described herein.

No license, express or implied, by estoppel or otherwise, to any intellectual property rights is granted under this document. If any part of this document refers to any third party products or services it shall not be deemed a license grant by ST for the use of such third party products or services, or any intellectual property contained therein or considered as a warranty covering the use in any manner whatsoever of such third party products or services or any intellectual property contained therein.

**UNLESS OTHERWISE SET FORTH IN ST'S TERMS AND CONDITIONS OF SALE ST DISCLAIMS ANY EXPRESS OR IMPLIED WARRANTY WITH RESPECT TO THE USE AND/OR SALE OF ST PRODUCTS INCLUDING WITHOUT LIMITATION IMPLIED WARRANTIES OF MERCHANTABILITY, FITNESS FOR A PARTICULAR PURPOSE (AND THEIR EQUIVALENTS UNDER THE LAWS OF ANY JURISDICTION), OR INFRINGEMENT OF ANY PATENT, COPYRIGHT OR OTHER INTELLECTUAL PROPERTY RIGHT.**

**UNLESS EXPRESSLY APPROVED IN WRITING BY AN AUTHORIZED ST REPRESENTATIVE, ST PRODUCTS ARE NOT RECOMMENDED, AUTHORIZED OR WARRANTED FOR USE IN MILITARY, AIR CRAFT, SPACE, LIFE SAVING, OR LIFE SUSTAINING APPLICATIONS, NOR IN PRODUCTS OR SYSTEMS WHERE FAILURE OR MALFUNCTION MAY RESULT IN PERSONAL INJURY, DEATH, OR SEVERE PROPERTY OR ENVIRONMENTAL DAMAGE. ST PRODUCTS WHICH ARE NOT SPECIFIED AS "AUTOMOTIVE GRADE" MAY ONLY BE USED IN AUTOMOTIVE APPLICATIONS AT USER'S OWN RISK.**

Resale of ST products with provisions different from the statements and/or technical features set forth in this document shall immediately void any warranty granted by ST for the ST product or service described herein and shall not create or extend in any manner whatsoever, any liability of ST.

ST and the ST logo are trademarks or registered trademarks of ST in various countries.

Information in this document supersedes and replaces all information previously supplied.

The ST logo is a registered trademark of STMicroelectronics. All other names are the property of their respective owners.

© 2009 STMicroelectronics - All rights reserved

STMicroelectronics group of companies

Australia - Belgium - Brazil - Canada - China - Czech Republic - Finland - France - Germany - Hong Kong - India - Israel - Italy - Japan - Malaysia - Malta - Morocco - Philippines - Singapore - Spain - Sweden - Switzerland - United Kingdom - United States of America

[www.st.com](http://www.st.com)





**Стандарт  
Электрон  
Связь**

Мы молодая и активно развивающаяся компания в области поставок электронных компонентов. Мы поставляем электронные компоненты отечественного и импортного производства напрямую от производителей и с крупнейших складов мира.

Благодаря сотрудничеству с мировыми поставщиками мы осуществляем комплексные и плановые поставки широчайшего спектра электронных компонентов.

Собственная эффективная логистика и склад в обеспечивает надежную поставку продукции в точно указанные сроки по всей России.

Мы осуществляем техническую поддержку нашим клиентам и предпродажную проверку качества продукции. На все поставляемые продукты мы предоставляем гарантию .

Осуществляем поставки продукции под контролем ВП МО РФ на предприятия военно-промышленного комплекса России , а также работаем в рамках 275 ФЗ с открытием отдельных счетов в уполномоченном банке. Система менеджмента качества компании соответствует требованиям ГОСТ ISO 9001.

Минимальные сроки поставки, гибкие цены, неограниченный ассортимент и индивидуальный подход к клиентам являются основой для выстраивания долгосрочного и эффективного сотрудничества с предприятиями радиоэлектронной промышленности, предприятиями ВПК и научно-исследовательскими институтами России.

С нами вы становитесь еще успешнее!

**Наши контакты:**

**Телефон:** +7 812 627 14 35

**Электронная почта:** [sales@st-electron.ru](mailto:sales@st-electron.ru)

**Адрес:** 198099, Санкт-Петербург,  
Промышленная ул, дом № 19, литера Н,  
помещение 100-Н Офис 331