

FEATURES

- Trimmed to High Accuracy: 0.075% Max
- Low Drift: 10ppm/°C Max
- Industrial Temperature Range
- Temperature Coefficient Guaranteed to 125°C
- Low Supply Current: 130µA Max (LT1460-2.5)
- Minimum Output Current: 20mA
- No Output Capacitor Required
- Reverse Battery Protection
- Minimum Input/Output Differential: 0.9V
- Available in SO-8, MSOP-8, PDIP-8, TO-92 and SOT-23 Package

APPLICATIONS

- Handheld Instruments
- Precision Regulators
- A/D and D/A Converters
- Power Supplies
- Hard Disk Drives

DESCRIPTION

The LT®1460 is a micropower bandgap reference that combines very high accuracy and low drift with low power dissipation and small package size. This series reference uses curvature compensation to obtain low temperature coefficient and trimmed precision thin-film resistors to achieve high output accuracy. The reference will supply up to 20mA with excellent line regulation characteristics, making it ideal for precision regulator applications.

This series reference provides supply current and power dissipation advantages over shunt references that must idle the entire load current to operate. Additionally, the LT1460 does not require an output compensation capacitor, yet is stable with capacitive loads. This feature is important where PC board space is a premium or fast settling is demanded. In the event of a reverse battery connection, these references will not conduct current, and are therefore protected from damage.

The LT1460 is available in the 8-lead MSOP, SO, PDIP and the 3-lead TO-92 and SOT23 packages.

LT, LT, LTC, LTM, Linear Technology and the Linear logo are registered trademarks of Linear Technology Corporation. All other trademarks are the property of their respective owners.

TYPICAL APPLICATION

Basic Connection



Typical Distribution of Output Voltage
 S8 Package



ABSOLUTE MAXIMUM RATINGS

(Note 1)

Input Voltage.....	30V
Reverse Voltage.....	-15V
Output Short-Circuit Duration, $T_A = 25^\circ\text{C}$	
$V_{IN} > 10\text{V}$	5 sec
$V_{IN} \leq 10\text{V}$	Indefinite

Specified Temperature Range (Note 10)

Commercial (C).....	0°C to 70°C
Industrial (I).....	-40°C to 85°C
High (H).....	-40°C to 125°C
Storage Temperature Range (Note 2).....	-65°C to 150°C
Lead Temperature (Soldering, 10 sec).....	300°C

PIN CONFIGURATION

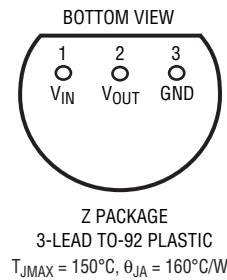
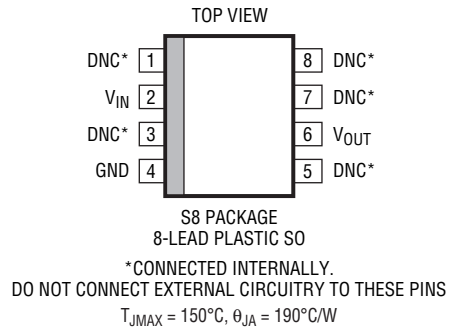
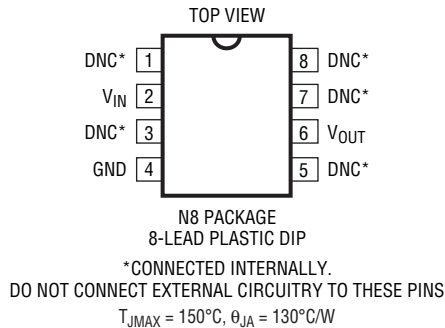

ORDER INFORMATION

Lead Free Finish

TAPE AND REEL (MINI)	TAPE AND REEL	PART MARKING*	PACKAGE DESCRIPTION	SPECIFIED TEMPERATURE RANGE
LT1460HCS3-2.5#TRMPBF	LT1460HCS3-2.5#TRMPBF	LTAC or LTH8†	3-Lead Plastic SOT-23	0°C to 70°C
LT1460JCS3-2.5#TRMPBF	LT1460JCS3-2.5#TRPBF	LTAD or LTH8†	3-Lead Plastic SOT-23	0°C to 70°C
LT1460KCS3-2.5#TRMPBF	LT1460KCS3-2.5#TRPBF	LTAE or LTH8†	3-Lead Plastic SOT-23	0°C to 70°C
LT1460HCS3-3#TRMPBF	LT1460HCS3-3#TRPBF	LTAN or LTH9†	3-Lead Plastic SOT-23	0°C to 70°C
LT1460JCS3-3#TRMPBF	LT1460JCS3-3#TRPBF	LTAP or LTH9†	3-Lead Plastic SOT-23	0°C to 70°C
LT1460KCS3-3#TRMPBF	LT1460KCS3-3#TRPBF	LTAQ or LTH9†	3-Lead Plastic SOT-23	0°C to 70°C
LT1460HCS3-3.3#TRMPBF	LT1460HCS3-3.3#TRPBF	LTAR or LTJ1†	3-Lead Plastic SOT-23	0°C to 70°C
LT1460JCS3-3.3#TRMPBF	LT1460JCS3-3.3#TRPBF	LTAS or LTJ1†	3-Lead Plastic SOT-23	0°C to 70°C
LT1460KCS3-3.3#TRMPBF	LT1460KCS3-3.3#TRPBF	LTAT or LTJ1†	3-Lead Plastic SOT-23	0°C to 70°C
LT1460HCS3-5#TRMPBF	LT1460HCS3-5#TRPBF	LTAK or LTJ2†	3-Lead Plastic SOT-23	0°C to 70°C
LT1460JCS3-5#TRMPBF	LT1460JCS3-5#TRPBF	LTAL or LTJ2†	3-Lead Plastic SOT-23	0°C to 70°C
LT1460KCS3-5#TRMPBF	LT1460KCS3-5#TRPBF	LTAM or LTJ2†	3-Lead Plastic SOT-23	0°C to 70°C
LT1460HCS3-10#TRMPBF	LT1460HCS3-10#TRPBF	LTAV or LTJ3†	3-Lead Plastic SOT-23	0°C to 70°C
LT1460JCS3-10#TRMPBF	LT1460JCS3-10#TRPBF	LTAU or LTJ3†	3-Lead Plastic SOT-23	0°C to 70°C
LT1460KCS3-10#TRMPBF	LT1460KCS3-10#TRPBF	LTAW or LTJ3†	3-Lead Plastic SOT-23	0°C to 70°C

TRM = 500 pieces. *Temperature grades and parametric grades are identified by a label on the shipping container.

†Product grades are identified with either part marking.

Consult LTC Marketing for parts specified with wider operating temperature ranges.

Consult LTC Marketing for information on lead based finish parts.

For more information on lead free part marking, go to: <http://www.linear.com/leadfree/>

For more information on tape and reel specifications, go to: <http://www.linear.com/tapeandreel/>

LEAD FREE FINISH	TAPE AND REEL	PART MARKING	PACKAGE DESCRIPTION	SPECIFIED TEMPERATURE RANGE
LT1460ACN8-2.5#PBF	LT1460ACN8-2.5#TRPBF		8-Lead Plastic DIP	0°C to 70°C
LT1460BIN8-2.5#PBF	LT1460BIN8-2.5#TRPBF		8-Lead Plastic DIP	-40°C to 85°C
LT1460DCN8-2.5#PBF	LT1460DCN8-2.5#TRPBF		8-Lead Plastic DIP	0°C to 70°C
LT1460EIN8-2.5#PBF	LT1460EIN8-2.5#TRPBF		8-Lead Plastic DIP	-40°C to 85°C
LT1460ACN8-5#PBF	LT1460ACN8-5#TRPBF		8-Lead Plastic DIP	0°C to 70°C
LT1460BIN8-5#PBF	LT1460BIN8-5#TRPBF		8-Lead Plastic DIP	-40°C to 85°C
LT1460DCN8-5#PBF	LT1460DCN8-5#TRPBF		8-Lead Plastic DIP	0°C to 70°C
LT1460EIN8-5#PBF	LT1460EIN8-5#TRPBF		8-Lead Plastic DIP	-40°C to 85°C
LT1460ACN8-10#PBF	LT1460ACN8-10#TRPBF		8-Lead Plastic DIP	0°C to 70°C
LT1460BIN8-10#PBF	LT1460BIN8-10#TRPBF		8-Lead Plastic DIP	-40°C to 85°C
LT1460DCN8-10#PBF	LT1460DCN8-10#TRPBF		8-Lead Plastic DIP	0°C to 70°C
LT1460EIN8-10#PBF	LT1460EIN8-10#TRPBF		8-Lead Plastic DIP	-40°C to 85°C
LT1460ACS8-2.5#PBF	LT1460ACS8-2.5#TRPBF	1460A2	8-Lead Plastic SO	0°C to 70°C
LT1460BIS8-2.5#PBF	LT1460BIS8-2.5#TRPBF	460BI2	8-Lead Plastic SO	-40°C to 85°C
LT1460DCS8-2.5#PBF	LT1460DCS8-2.5#TRPBF	1460D2	8-Lead Plastic SO	0°C to 70°C
LT1460EIS8-2.5#PBF	LT1460EIS8-2.5#TRPBF	460EI2	8-Lead Plastic SO	-40°C to 85°C
LT1460LHS8-2.5#PBF	LT1460LHS8-2.5#TRPBF	60LH25	8-Lead Plastic SO	0°C to 70°C
LT1460MHS8-2.5#PBF	LT1460MHS8-2.5#TRPBF	60MH25	8-Lead Plastic SO	-40°C to 85°C
LT1460ACS8-5#PBF	LT1460ACS8-5#TRPBF	1460A5	8-Lead Plastic SO	0°C to 70°C
LT1460BIS8-5#PBF	LT1460BIS8-5#TRPBF	460BI5	8-Lead Plastic SO	-40°C to 85°C

ORDER INFORMATION

LEAD FREE FINISH	TAPE AND REEL	PART MARKING	PACKAGE DESCRIPTION	SPECIFIED TEMPERATURE RANGE
LT1460DCS8-5#PBF	LT1460DCS8-5#TRPBF	1460D5	8-Lead Plastic SO	0°C to 70°C
LT1460EIS8-5#PBF	LT1460EIS8-5#TRPBF	460EI5	8-Lead Plastic SO	-40°C to 85°C
LT1460LHS8-5#PBF	LT1460LHS8-5#TRPBF	460LH5	8-Lead Plastic SO	0°C to 70°C
LT1460MHS8-5#PBF	LT1460MHS8-5#TRPBF	460MH5	8-Lead Plastic SO	-40°C to 85°C
LT1460ACS8-10#PBF	LT1460ACS8-10#TRPBF	1460A1	8-Lead Plastic SO	0°C to 70°C
LT1460BIS8-10#PBF	LT1460BIS8-10#TRPBF	460BI1	8-Lead Plastic SO	-40°C to 85°C
LT1460DCS8-10#PBF	LT1460DCS8-10#TRPBF	1460D1	8-Lead Plastic SO	0°C to 70°C
LT1460EIS8-10#PBF	LT1460EIS8-10#TRPBF	460EI1	8-Lead Plastic SO	-40°C to 85°C
LT1460CCMS8-2.5#PBF	LT1460CCMS8-2.5#TRPBF	LTAA	8-Lead Plastic MSOP	0°C to 70°C
LT1460FCMS8-2.5#PBF	LT1460FCMS8-2.5#TRPBF	LTAB	8-Lead Plastic MSOP	0°C to 70°C
LT1460CCMS8-5#PBF	LT1460CCMS8-5#TRPBF	LTAJ	8-Lead Plastic MSOP	0°C to 70°C
LT1460FCMS8-5#PBF	LT1460FCMS8-5#TRPBF	LTAG	8-Lead Plastic MSOP	0°C to 70°C
LT1460CCMS8-10#PBF	LT1460CCMS8-10#TRPBF	LTAH	8-Lead Plastic MSOP	0°C to 70°C
LT1460FCMS8-10#PBF	LT1460FCMS8-10#TRPBF	LTAJ	8-Lead Plastic MSOP	0°C to 70°C
LT1460GCZ-2.5#PBF	LT1460GCZ-2.5#TRPBF		3-Lead Plastic TO-92	0°C to 70°C
LT1460GIZ-2.5#PBF	LT1460GIZ-2.5#TRPBF		3-Lead Plastic TO-92	-40°C to 85°C
LT1460GCZ-5#PBF	LT1460GCZ-5#TRPBF		3-Lead Plastic TO-92	0°C to 70°C
LT1460GIZ-5#PBF	LT1460GIZ-5#TRPBF		3-Lead Plastic TO-92	-40°C to 85°C
LT1460GCZ-10#PBF	LT1460GCZ-10#TRPBF		3-Lead Plastic TO-92	0°C to 70°C
LT1460GIZ-10#PBF	LT1460GIZ-10#TRPBF		3-Lead Plastic TO-92	-40°C to 85°C

Consult LTC Marketing for parts specified with wider operating temperature ranges.

Consult LTC Marketing for information on non-standard lead based finish parts.

For more information on lead free part marking, go to: <http://www.linear.com/leadfree/>

For more information on tape and reel specifications, go to: <http://www.linear.com/tapeandreeel/>

AVAILABLE OPTIONS

TEMPERATURE	ACCURACY (%)	TEMPERATURE COEFFICIENT (ppm/°C)	PACKAGE TYPE				
			N8	S8	MS8	Z	S3
0°C to 70°C	0.075	10	LT1460ACN8	LT1460ACS8			
-40°C to 85°C	0.10	10	LT1460BIN8	LT1460BIS8			
0°C to 70°C	0.10	15			LT1460CCMS8		
0°C to 70°C	0.10	20	LT1460DCN8	LT1460DCS8			
-40°C to 85°C	0.125	20	LT1460EIN8	LT1460EIS8			
0°C to 70°C	0.15	25			LT1460FCMS8		
0°C to 70°C	0.25	25				LT1460GCZ	
-40°C to 85°C	0.25	25				LT1460GIZ	
-40°C to 85°C/125°C	0.20	20/50		LT1460LHS8			
-40°C to 125°C	0.20	50		LT1460MHS8			
0°C to 70°C	0.20	20					LT1460HCS3
0°C to 70°C	0.40	20					LT1460JCS3
0°C to 70°C	0.50	50					LT1460KCS3

1460fc

ELECTRICAL CHARACTERISTICS The ● denotes the specifications which apply over the full operating temperature range, otherwise specifications are at $T_A = 25^\circ\text{C}$. $V_{IN} = V_{OUT} + 2.5\text{V}$, $I_{OUT} = 0$ unless otherwise specified.

PARAMETER	CONDITIONS	MIN	TYP	MAX	UNITS	
Output Voltage	LT1460ACN8-2.5, ACS8-2.5	2.49813 -0.075		2.50188 0.075	V %	
	LT1460BIN8-2.5, BIS8-2.5, CCMS8-2.5, DCN8-2.5, DCS8-2.5	2.4975 -0.10		2.5025 0.10	V %	
	LT1460EIN8-2.5, EIS8-2.5	2.49688 -0.125		2.50313 0.125	V %	
	LT1460FCMS8-2.5	2.49625 -0.15		2.50375 0.15	V %	
	LT1460GCZ-2.5, GIZ-2.5	2.49375 -0.25		2.50625 0.25	V %	
	LT1460LHS8-2.5, MHS8-2.5	2.495 -0.20		2.505 0.20	V %	
	LT1460ACN8-5, ACS8-5	4.99625 -0.075		5.00375 0.075	V %	
	LT1460BIN8-5, BIS8-5, CCMS8-5, DCN8-5, DCS8-5	4.995 -0.10		5.005 0.10	V %	
	LT1460EIN8-5, EIS8-5	4.99375 -0.125		5.00625 0.125	V %	
	LT1460FCMS8-5	4.9925 -0.15		5.0075 0.15	V %	
	LT1460GCZ-5, GIZ-5	4.9875 -0.25		5.0125 0.25	V %	
	LT1460LHS8-5, MHS8-5	4.990 -0.20		5.010 0.20	V %	
	LT1460ACN8-10, ACS8-10	9.9925 -0.075		10.0075 0.075	V %	
	LT1460BIN8-10, BIS8-10, CCMS8-10, DCN8-10, DCS8-10	9.990 -0.10		10.010 0.10	V %	
	LT1460EIN8-10, EIS8-10	9.9875 -0.125		10.0125 0.125	V %	
	LT1460FCMS8-10	9.985 -0.15		10.0015 0.15	V %	
	LT1460GCZ-10, GIZ-10	9.975 -0.25		10.025 0.25	V %	
	LT1460HC LT1460JC LT1460KC		-0.2 -0.4 -0.5		0.2 0.4 0.5	% % %
	Output Voltage Temperature Coefficient (Note 3)	$T_{MIN} \leq T_J \leq T_{MAX}$				
		LT1460ACN8, ACS8, BIN8, BIS8	●	5	10	ppm/°C
LT1460CCMS8		●	7	15	ppm/°C	
LT1460DCN8, DCS8, EIN8, EIS8		●	10	20	ppm/°C	
LT1460FCMS8, GCZ, GIZ		●	12	25	ppm/°C	
LT1460LHS8 -40°C to 85°C		●	10	20	ppm/°C	
-40°C to 125°C		●	25	50	ppm/°C	
LT1460MHS8 -40°C to 125°C		●	25	50	ppm/°C	
LT1460HC		●	10	20	ppm/°C	
LT1460JC		●	10	20	ppm/°C	
LT1460KC	●	25	50	ppm/°C		

LT1460

ELECTRICAL CHARACTERISTICS

The ● denotes the specifications which apply over the full operating temperature range, otherwise specifications are at $T_A = 25^\circ\text{C}$. $V_{IN} = V_{OUT} + 2.5\text{V}$, $I_{OUT} = 0$ unless otherwise specified.

PARAMETER	CONDITIONS	MIN	TYP	MAX	UNITS
Line Regulation LT1460A, LT1460B, LT1460C, LT1460D, LT1460E, LT1460F, LT1460G, LT1460H, LT1460L, LT1460M LT1460HC, LT1460JC, LT1460KC	$V_{OUT} + 0.9\text{V} \leq V_{IN} \leq V_{OUT} + 2.5\text{V}$	●	30	60 80	ppm/V ppm/V
	$V_{OUT} + 2.5\text{V} \leq V_{IN} \leq 20\text{V}$	●	10	25 35	ppm/V ppm/V
	$V_{OUT} + 0.9\text{V} \leq V_{IN} \leq V_{OUT} + 2.5\text{V}$	●	150	800 1000	ppm/V ppm/V
	$V_{OUT} + 2.5\text{V} \leq V_{IN} \leq 20\text{V}$	●	50	100 130	ppm/V ppm/V
Load Regulation Sourcing (Note 4) LT1460A, LT1460B, LT1460C, LT1460D, LT1460E, LT1460F, LT1460G, LT1460H, LT1460L, LT1460M LT1460HC, LT1460JC, LT1460KC	$I_{OUT} = 100\mu\text{A}$	●	1500	2800 3500	ppm/mA ppm/mA
	$I_{OUT} = 10\text{mA}$	●	80	135 180	ppm/mA ppm/mA
	$I_{OUT} = 20\text{mA}$ 0°C to 70°C	●	70	100 140	ppm/mA ppm/mA
	$I_{OUT} = 100\mu\text{A}$	●	1000	3000 4000	ppm/mA ppm/mA
	$I_{OUT} = 10\text{mA}$	●	50	200 300	ppm/mA ppm/mA
	$I_{OUT} = 20\text{mA}$	●	20	70 100	ppm/mA ppm/mA
Thermal Regulation (Note 5) LT1460A, LT1460B, LT1460C, LT1460D, LT1460E, LT1460F, LT1460G, LT1460H, LT1460L, LT1460M LT1460HC, LT1460JC, LT1460KC	$\Delta P = 200\text{mW}$		0.5	2.5	ppm/mW
	$\Delta P = 200\text{mW}$		2.5	10	ppm/mW
Dropout Voltage (Note 6)	$V_{IN} - V_{OUT}$, $I_{OUT} = 0$	●		0.9	V
	$V_{IN} - V_{OUT}$, $I_{OUT} = 10\text{mA}$	●		1.3 1.4	V V
Output Current	Short V_{OUT} to GND		40		mA
Reverse Leakage	$V_{IN} = -15\text{V}$	●	0.5	10	μA
Supply Current	LT1460-2.5	●	100	130 165	μA μA
	LT1460-5	●	125	175 225	μA μA
	LT1460-10	●	190	270 360	μA μA
	LT1460S3-2.5	●	115	145 175	μA μA
	LT1460S3-3	●	145	180 220	μA μA
	LT1460S3-3.3	●	145	180 220	μA μA
	LT1460S3-5	●	160	200 240	μA μA
	LT1460S3-10	●	215	270 350	μA μA

ELECTRICAL CHARACTERISTICS The ● denotes the specifications which apply over the full operating temperature range, otherwise specifications are at $T_A = 25^\circ\text{C}$. $V_{IN} = V_{OUT} + 2.5\text{V}$, $I_{OUT} = 0$ unless otherwise specified.

PARAMETER	CONDITIONS		MIN	TYP	MAX	UNITS
Output Voltage Noise (Note 7) LT1460A, LT1460B, LT1460C, LT1460D, LT1460E, LT1460F, LT1460G, LT1460H, LT1460L, LT1460M	LT1460-2.5	$0.1\text{Hz} \leq f \leq 10\text{Hz}$		10		$\mu\text{V}_{\text{P-P}}$
		$10\text{Hz} \leq f \leq 1\text{kHz}$		10		μV_{RMS}
	LT1460-5	$0.1\text{Hz} \leq f \leq 10\text{Hz}$		20		$\mu\text{V}_{\text{P-P}}$
		$10\text{Hz} \leq f \leq 1\text{kHz}$		20		μV_{RMS}
LT1460-10	$0.1\text{Hz} \leq f \leq 10\text{Hz}$		40		$\mu\text{V}_{\text{P-P}}$	
	$10\text{Hz} \leq f \leq 1\text{kHz}$		35		μV_{RMS}	
LT1460HC, LT1460JC, LT1460KC	$0.1\text{Hz} \leq f \leq 10\text{Hz}$ $10\text{Hz} \leq f \leq 1\text{kHz}$			4		ppm (P-P)
				4		ppm (RMS)
Long-Term Stability of Output Voltage (Note 8) S8 Pkg LT1460HC, LT1460JC, LT1460KC				40		ppm/ $\sqrt{\text{kHr}}$
				100		ppm/ $\sqrt{\text{kHr}}$
Hysteresis (Note 9) LT1460A, LT1460B, LT1460C, LT1460D, LT1460E, LT1460F, LT1460G, LT1460H, LT1460L, LT1460M LT1460HC, LT1460JC, LT1460KC	$\Delta T = 0^\circ\text{C}$ to 70°C $\Delta T = -40^\circ\text{C}$ to 85°C			25		ppm
				160		ppm
	$\Delta T = 0^\circ\text{C}$ to 70°C $\Delta T = -40^\circ\text{C}$ to 85°C	●		50		ppm
		●		250		ppm

Note 1: Stresses beyond those listed under Absolute Maximum Ratings may cause permanent damage to the device. Exposure to any Absolute Maximum Rating condition for extended periods may affect device reliability and lifetime.

Note 2: If the part is stored outside of the specified temperature range, the output may shift due to hysteresis.

Note 3: Temperature coefficient is measured by dividing the change in output voltage by the specified temperature range. Incremental slope is also measured at 25°C .

Note 4: Load regulation is measured on a pulse basis from no load to the specified load current. Output changes due to die temperature change must be taken into account separately.

Note 5: Thermal regulation is caused by die temperature gradients created by load current or input voltage changes. This effect must be added to normal line or load regulation. This parameter is not 100% tested.

Note 6: Excludes load regulation errors. For LT1460S3, $\Delta V_{OUT} \leq 0.2\%$. For all other packages, $\Delta V_{OUT} \leq 0.1\%$.

Note 7: Peak-to-peak noise is measured with a single highpass filter at 0.1Hz and 2-pole lowpass filter at 10Hz. The unit is enclosed in a still-air environment to eliminate thermocouple effects on the leads. The test time is 10 sec. RMS noise is measured with a single highpass filter at 10Hz and a 2-pole lowpass filter at 1kHz. The resulting output is full wave rectified

and then integrated for a fixed period, making the final reading an average as opposed to RMS. A correction factor of 1.1 is used to convert from average to RMS and a second correction of 0.88 is used to correct for the nonideal pass band of the filters.

Note 8: Long-term stability typically has a logarithmic characteristic and therefore, changes after 1000 hours tend to be much smaller than before that time. Total drift in the second thousand hours is normally less than one third that of the first thousand hours with a continuing trend toward reduced drift with time. Significant improvement in long-term drift can be realized by preconditioning the IC with a 100 hour to 200 hour, 125°C burn-in. Long-term stability will also be affected by differential stresses between the IC and the board material created during board assembly. See PC Board Layout in the Applications Information section.

Note 9: Hysteresis in output voltage is created by package stress that differs depending on whether the IC was previously at a higher or lower temperature. Output voltage is always measured at 25°C , but the IC is cycled to 85°C or -40°C before successive measurements. Hysteresis is roughly proportional to the square of the temperature change. For instruments that are stored at reasonably well-controlled temperatures (within 20 or 30 degrees of operating temperature) hysteresis is generally not a problem.

Note 10: The LT1460S3 is guaranteed functional over the operating temperature range of -40° to 85°C .

TYPICAL PERFORMANCE CHARACTERISTICS

LT1460-2.5 (N8, S8, MS8, Z Packages)

2.5V Minimum Input-Output Voltage Differential



2.5V Load Regulation, Sourcing



2.5V Load Regulation, Sinking



2.5V Output Voltage Temperature Drift

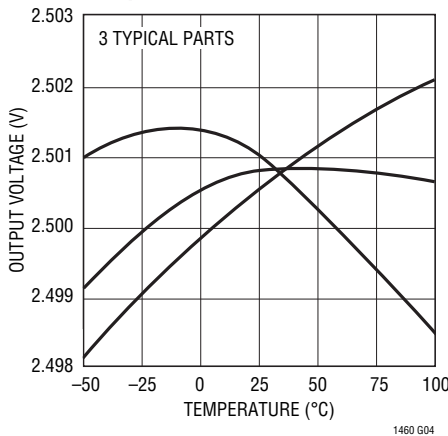

2.5V Supply Current vs Input Voltage



2.5V Line Regulation



2.5V Power Supply Rejection Ratio vs Frequency

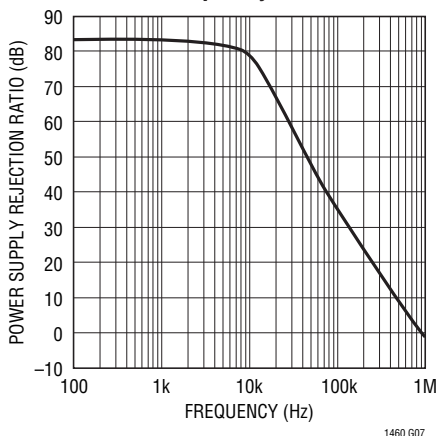

2.5V Output Impedance vs Frequency



2.5V Transient Responses



TYPICAL PERFORMANCE CHARACTERISTICS

2.5V Output Voltage Noise Spectrum

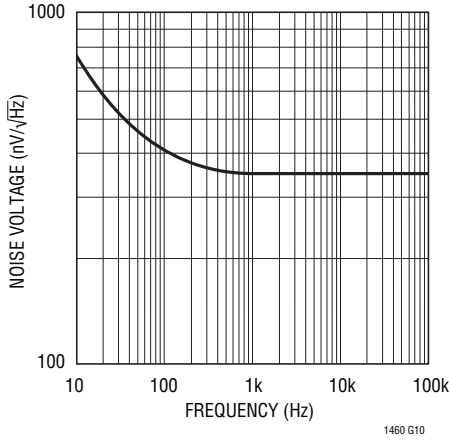

2.5V Output Noise 0.1Hz to 10Hz



2.5V Long-Term Drift Three Typical Parts (S8 Package)



LT1460-5 (N8, S8, MS8, Z Packages)

5V Minimum Input-Output Voltage Differential



5V Load Regulation, Sourcing



5V Load Regulation, Sinking

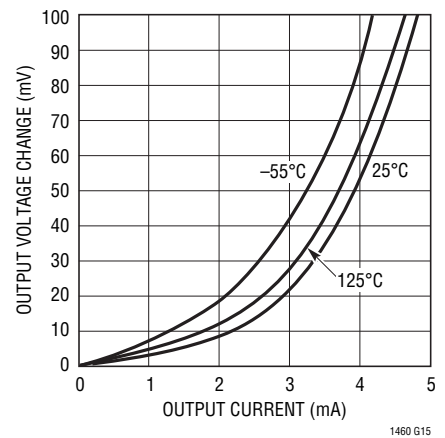

5V Output Voltage Temperature Drift



5V Supply Current vs Input Voltage



5V Line Regulation



TYPICAL PERFORMANCE CHARACTERISTICS

LT1460-5 (N8, S8, MS8, Z Packages)

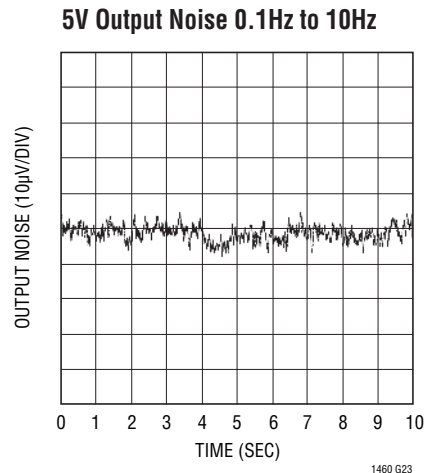
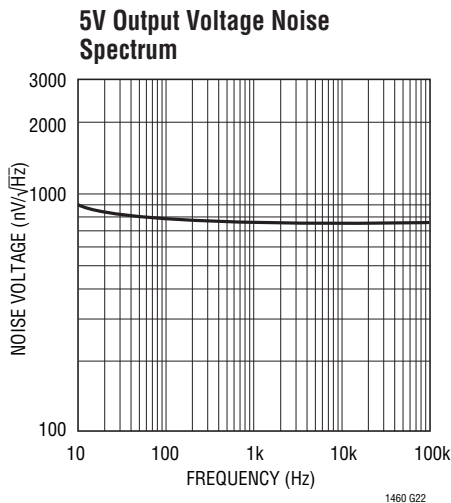

LT1460-10 (N8, S8, MS8, Z Packages)

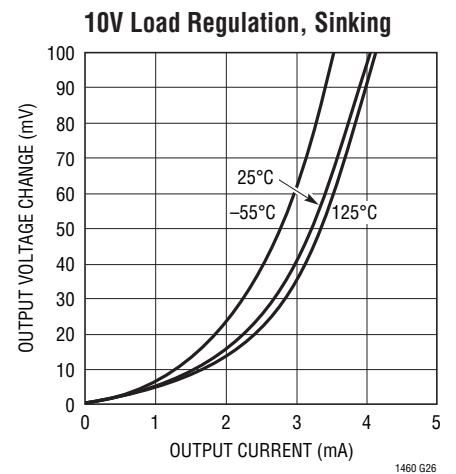
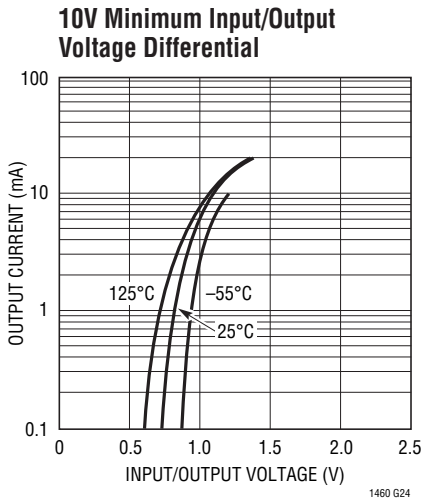

TYPICAL PERFORMANCE CHARACTERISTICS

10V Output Voltage Temperature Drift



10V Supply Current vs Input Voltage



10V Line Regulation

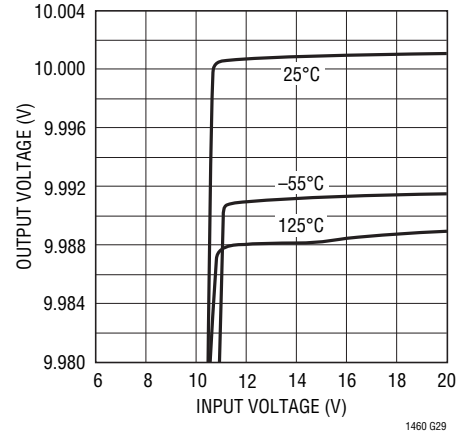

10V Power Supply Rejection Ratio vs Frequency

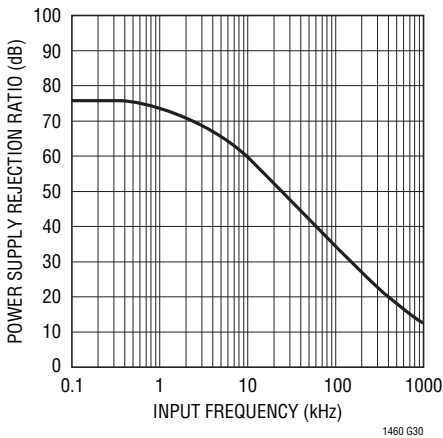

10V Output Impedance vs Frequency



10V Transient Responses



10V Output Voltage Noise Spectrum

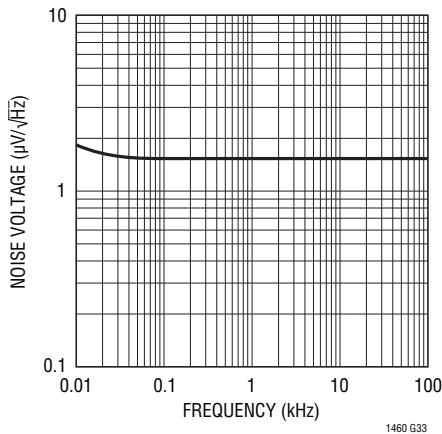

10V Output Noise 0.1Hz to 10Hz



TYPICAL PERFORMANCE CHARACTERISTICS

Characteristic curves are similar for all voltage options of the LT1460S3. Curves from the LT1460S3-2.5 and the LT1460S3-10 represent the extremes of the voltage options. Characteristic curves for other output voltages fall between these curves, and can be estimated based on their voltage output.

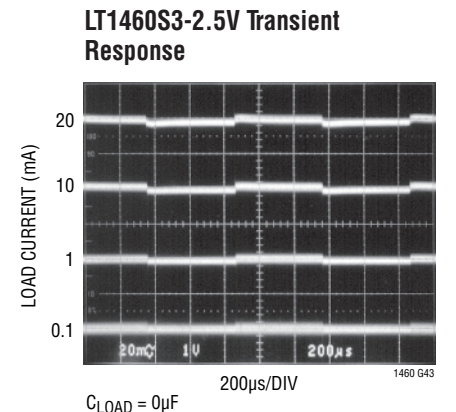
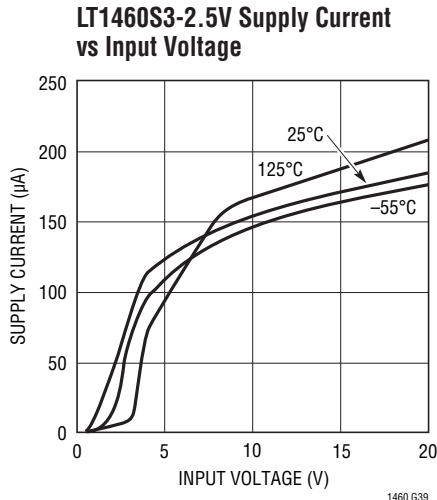

TYPICAL PERFORMANCE CHARACTERISTICS Characteristic curves are similar for all voltage options of the LT1460S3. Curves from the LT1460S3-2.5 and the LT1460S3-10 represent the extremes of the voltage options. Characteristic curves for other output voltages fall between these curves, and can be estimated based on their voltage output.

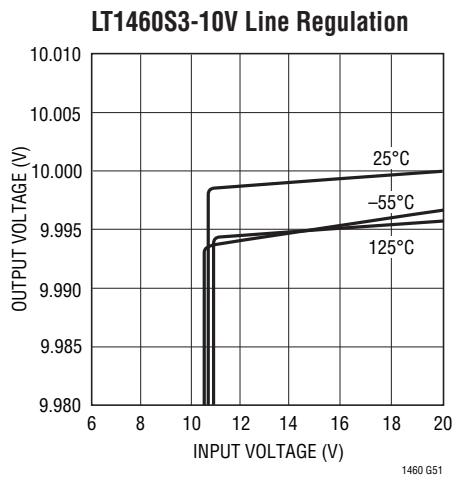

TYPICAL PERFORMANCE CHARACTERISTICS

Characteristic curves are similar for all voltage options of the LT1460S3. Curves from the LT1460S3-2.5 and the LT1460S3-10 represent the extremes of the voltage options. Characteristic curves for other output voltages fall between these curves, and can be estimated based on their voltage output.

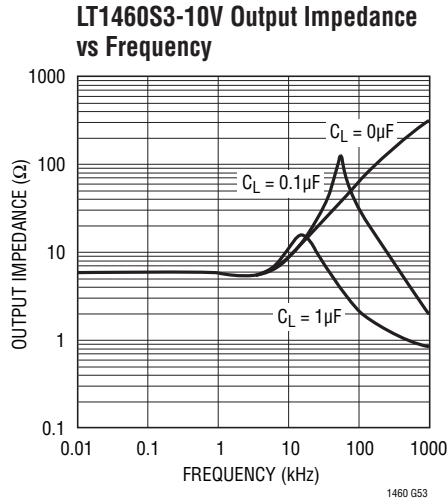

APPLICATIONS INFORMATION

Longer Battery Life

Series references have a large advantage over older shunt style references. Shunt references require a resistor from the power supply to operate. This resistor must be chosen to supply the maximum current that can ever be demanded by the circuit being regulated. When the circuit being controlled is not operating at this maximum current, the shunt reference must always sink this current, resulting in high dissipation and short battery life.

The LT1460 series reference does not require a current setting resistor and can operate with any supply voltage from $V_{OUT} + 0.9V$ to $20V$. When the circuitry being regulated does not demand current, the LT1460 reduces its dissipation and battery life is extended. If the reference is not delivering load current it dissipates only a few mW, yet the same configuration can deliver $20mA$ of load current when demanded.

Capacitive Loads

The LT1460 is designed to be stable with capacitive loads. With no capacitive load, the reference is ideal for fast settling, applications where PC board space is a premium, or where available capacitance is limited.

The test circuit for the LT1460-2.5 shown in Figure 1 is used to measure the response time for various load currents and load capacitors. The $1V$ step from $2.5V$ to $1.5V$ produces a current step of $1mA$ or $100\mu A$ for $R_L = 1k$ or $R_L = 10k$. Figure 2 shows the response of the reference with no load capacitance.

The reference settles to $2.5mV$ (0.1%) in less than $1\mu s$ for a $100\mu A$ pulse and to 0.1% in $1.5\mu s$ with a $1mA$ step. When load capacitance is greater than $0.01\mu F$, the reference begins to ring due to the pole formed with the output impedance. Figure 3 shows the response of the reference to a $1mA$ and $100\mu A$ load current step with a $0.01\mu F$ load capacitor. The ringing can be greatly reduced with a DC load as small as $200\mu A$. With large output capacitors, $\geq 1\mu F$,

the ringing can be reduced with a small resistor in series with the reference output as shown in Figure 4. Figure 5 shows the response of the LT1460-2.5 with a $R_S = 2\Omega$ and



Figure 2. $C_L = 0$



Figure 3. $C_L = 0.01\mu F$



Figure 4. Isolation Resistor Test Circuit



Figure 5. Effect of R_S for $C_L = 1\mu F$



Figure 1. Response Time Test Circuit

APPLICATIONS INFORMATION

$C_L = 1\mu\text{F}$. R_S should not be made arbitrarily large because it will limit the load regulation.

Figure 6 to Figure 8 illustrate response in the LT1460-5. The 1V step from 5V to 4V produces a current step of 1mA or 100 μA for $R_L = 1\text{k}$ or $R_L = 10\text{k}$. Figure 7 shows the response of the reference with no load capacitance.

The reference settles to 5mV (0.1%) in less than 2 μs for a 100 μA pulse and to 0.1% in 3 μs with a 1mA step. When load capacitance is greater than 0.01 μF , the reference begins to ring due to the pole formed with the output impedance. Figure 8 shows the response of the reference to a 1mA

and 100 μA load current step with a 0.01 μF load capacitor. Figure 9 to Figure 11 illustrate response of the LT1460-10. The 1V step from 10V to 9V produces a current step of 1mA or 100 μA for $R_L = 1\text{k}$ or $R_L = 10\text{k}$. Figure 10 shows the response of the reference with no load capacitance.

The reference settles to 10mV (0.1%) in 0.4 μs for a 100 μA pulse and to 0.1% in 0.8 μs with a 1mA step. When load capacitance is greater than 0.01 μF , the reference begins to ring due to the pole formed with the output impedance. Figure 11 shows the response of the reference to a 1mA and 100 μA load current step with a 0.01 μF load capacitor.

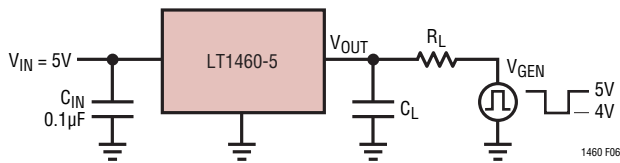

Figure 6. Response Time Test Circuit

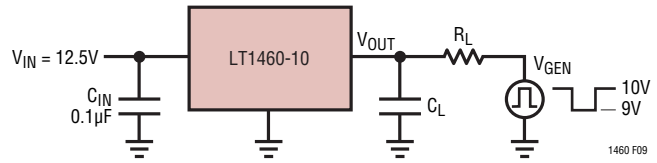

Figure 9. Response Time Test Circuit

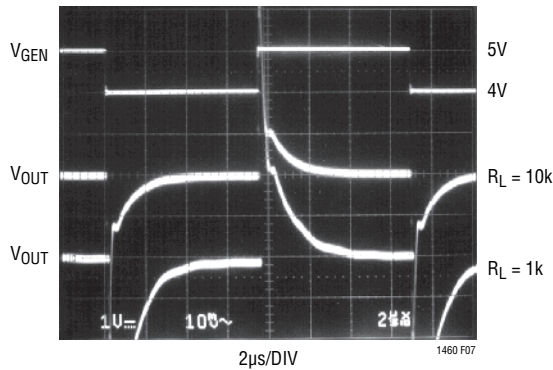

Figure 7. $C_L = 0$

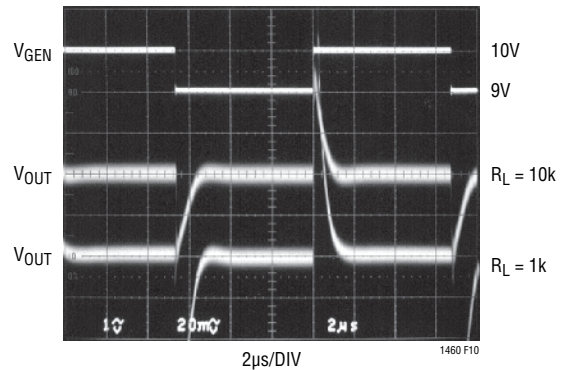

Figure 10. $C_L = 0$

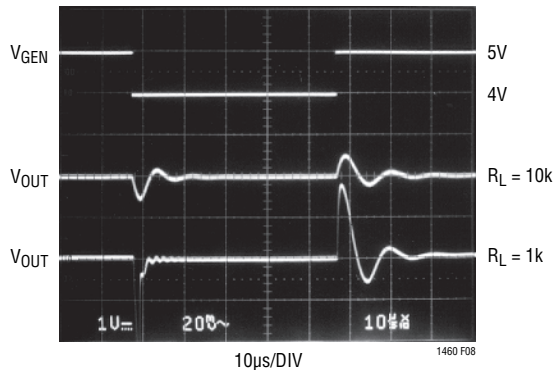

Figure 8. $C_L = 0.01\mu\text{F}$

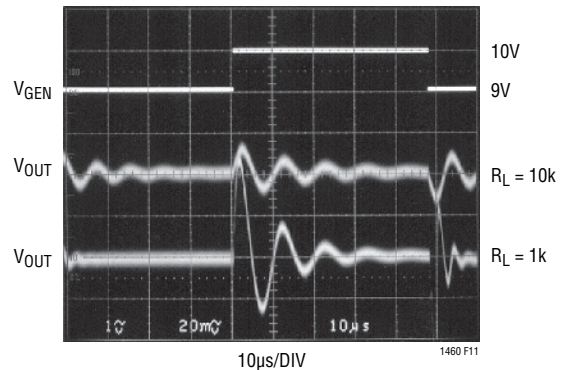

Figure 11. $C_L = 0.01\mu\text{F}$

APPLICATIONS INFORMATION

The LT1460S3 family of references are designed to be stable with a large range of capacitive loads. With no capacitive load, these references are ideal for fast settling or applications where PC board space is a premium. The test circuit shown in Figure 12 is used to measure the response time and stability of various load currents and load capacitors. This circuit is set for the 2.5V option. For other voltage options, the input voltage must be scaled up and the output voltage generator offset voltage must be adjusted. The 1V step from 2.5V to 1.5V produces a current step of 10mA or 1mA for $R_L = 100\Omega$ or $R_L = 1k$. Figure 13 shows the response of the reference to these



Figure 12. Response Time Test Circuit



Figure 13. $C_L = 0\mu F$

1mA and 10mA load steps with no load capacitance, and Figure 14 shows a 1mA and 10mA load step with a 0.1µF output capacitor. Figure 15 shows the response to a 1mA load step with $C_L = 1\mu F$ and 4.7µF.

The frequency compensation of the LT1460S3 version is slightly different than that of the other packages. Additional care must be taken when choosing load capacitance in an application circuit.

Table 1 gives the maximum output capacitance for various load currents and output voltages of the LT1460S3 to avoid instability. Load capacitors with low ESR (effective series resistance) cause more ringing than capacitors with higher ESR such as polarized aluminum or tantalum capacitors.



Figure 14. $C_L = 0.1\mu F$

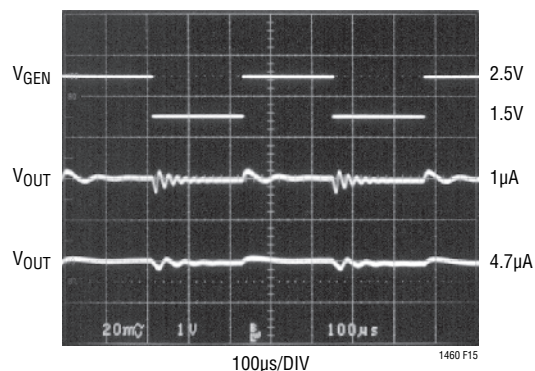

Figure 15. $I_{OUT} = 1mA$

APPLICATIONS INFORMATION

Table 1. Maximum Output Capacitance for LT1460S3

VOLTAGE OPTION	I _{OUT} = 100μA	I _{OUT} = 1mA	I _{OUT} = 10mA	I _{OUT} = 20mA
2.5V	>10μF	>10μF	2μF	0.68μF
3V	>10μF	>10μF	2μF	0.68μF
3.3V	>10μF	>10μF	1μF	0.68μF
5V	>10μF	>10μF	1μF	0.68μF
10V	>10μF	1μF	0.15μF	0.1μF

Long-Term Drift

Long-term drift cannot be extrapolated from accelerated high temperature testing. This erroneous technique gives drift numbers that are wildly optimistic. The only way long-term drift can be determined is to measure it over the time interval of interest. The LT1460S3 long-term drift data was taken on over 100 parts that were soldered into PC boards similar to a “real world” application. The boards were then placed into a constant temperature oven with T_A = 30°C, their outputs were scanned regularly and measured with an 8.5 digit DVM. Figure 16 shows typical long-term drift of the LT1460S3s.

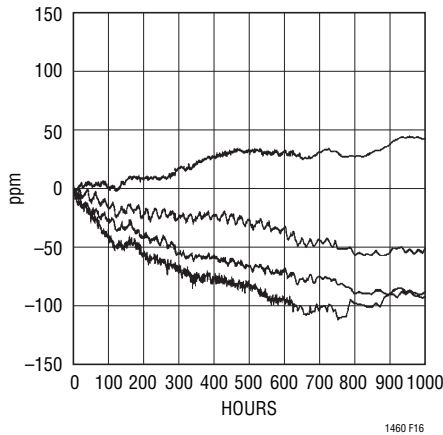

Figure 16. Typical Long-Term Drift

Hysteresis

Hysteresis data shown in Figure 17 and Figure 18 represents the worst-case data taken on parts from 0°C to 70°C and from -40°C to 85°C. The device is capable of dissipating relatively high power, i.e., for the LT1460S3-2.5, PD = 17.5V • 20mA = 350mW. The thermal resistance of the SOT-23 package is 325°C/W and this dissipation causes a 114°C internal rise producing a junction temperature of T_J = 25°C + 114°C = 139°C. This elevated temperature will cause the output to shift due to thermal hysteresis. **For highest performance in precision applications, do not let the LT1460S3’s junction temperature exceed 85°C.**



Figure 17. 0°C to 70°C Hysteresis

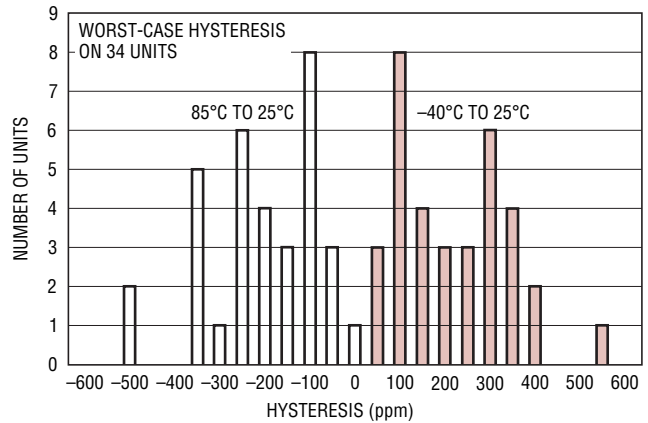

Figure 18. -40°C to 85°C Hysteresis

APPLICATIONS INFORMATION

Input Capacitance

It is recommended that a 0.1μF or larger capacitor be added to the input pin of the LT1460. This can help with stability when large load currents are demanded.

Output Accuracy

Like all references, either series or shunt, the error budget of the LT1460-2.5 is made up of primarily three components: initial accuracy, temperature coefficient and load regulation. Line regulation is neglected because it typically contributes only 30ppm/V, or 75μV for a 1V input change. The LT1460-2.5 typically shifts less than 0.01% when soldered into a PCB, so this is also neglected (see PC Board Layout section). The output errors are calculated as follows for a 100μA load and 0°C to 70°C temperature range:

LT1460AC

Initial accuracy = 0.075%

For $I_O = 100\mu\text{A}$, and using the LT1460-2.5 for calculation,

$$\Delta V_{\text{OUT}} = \left(\frac{3500\text{ppm}}{\text{mA}} \right) (0.1\text{mA})(2.5\text{V}) = 875\mu\text{V}$$

which is 0.035%.

For temperature 0°C to 70°C the maximum $\Delta T = 70^\circ\text{C}$,

$$\Delta V_{\text{OUT}} = \left(\frac{10\text{ppm}}{^\circ\text{C}} \right) (70^\circ\text{C})(2.5\text{V}) = 1.75\text{mV}$$

which is 0.07%.

Total worst-case output error is:

$$0.075\% + 0.035\% + 0.070\% = 0.180\%.$$

Table 1 gives worst-case accuracy for the LT1460AC, CC, DC, FC, GC from 0°C to 70°C and the LT1460BI, EI, GI from -40°C to 85°C.

Note that the LT1460-5 and LT1460-10 give identical accuracy as a fraction of their respective output voltages.

PC Board Layout

In 13- to 16-bit systems where initial accuracy and temperature coefficient calibrations have been done, the mechanical and thermal stress on a PC board (in a cardcage for instance) can shift the output voltage and mask the true temperature coefficient of a reference. In addition, the mechanical stress of being soldered into a PC board can cause the output voltage to shift from its ideal value. Surface mount voltage references (MS8 and S8) are the most susceptible to PC board stress because of the small amount of plastic used to hold the lead frame.

A simple way to improve the stress-related shifts is to mount the reference near the short edge of the PC board, or in a corner. The board edge acts as a stress boundary, or a region where the flexure of the board is minimum. The package should always be mounted so that the leads absorb the stress and not the package. The package is generally aligned with the leads parallel to the long side of the PC board as shown in Figure 20a.

A qualitative technique to evaluate the effect of stress on voltage references is to solder the part into a PC board and

Table 2. Worst-Case Output Accuracy Over Temperature

I_{OUT}	LT1460AC	LT1460BI	LT1460CC	LT1460DC	LT1460EI	LT1460FC	LT1460GC	LT1460GI	LT1460HC	LT1460JC	LT1460KC
0	0.145%	0.225%	0.205%	0.240%	0.375%	0.325%	0.425%	0.562%	0.340%	0.540%	0.850%
100μA	0.180%	0.260%	0.240%	0.275%	0.410%	0.360%	0.460%	0.597%	0.380%	0.580%	0.890%
10mA	0.325%	0.405%	0.385%	0.420%	0.555%	0.505%	0.605%	0.742%	0.640%	0.840%	1.15%
20mA	0.425%	N/A	0.485%	0.520%	N/A	0.605%	0.705%	N/A	0.540%	0.740%	1.05%

APPLICATIONS INFORMATION

deform the board a fixed amount as shown in Figure 19. The flexure #1 represents no displacement, flexure #2 is concave movement, flexure #3 is relaxation to no displacement and finally, flexure #4 is a convex movement. This motion is repeated for a number of cycles and the relative output deviation is noted. The result shown in Figure 20a is for two LT1460S8-2.5s mounted vertically and Figure 20b is for two LT1460S8-2.5s mounted horizontally. The parts oriented in Figure 20a impart less stress into the package because stress is absorbed in the leads. Figures 20a and 20b show the deviation to be between 125 μ V and

250 μ V and implies a 50ppm and 100ppm change respectively. This corresponds to a 13- to 14-bit system and is not a problem for most 10- to 12-bit systems unless the system has a calibration. In this case, as with temperature hysteresis, this low level can be important and even more careful techniques are required.

The most effective technique to improve PC board stress is to cut slots in the board around the reference to serve as a strain relief. These slots can be cut on three sides of the reference and the leads can exit on the fourth side. This “tongue” of PC board material can be oriented in the long direction of the board to further reduce stress transferred to the reference.

The results of slotting the PC boards of Figures 20a and 20b are shown in Figures 21a and 21b. In this example the slots can improve the output shift from about 100ppm to nearly zero.



Figure 19. Flexure Numbers



Figure 20a. Two Typical LT1460S8-2.5s, Vertical Orientation Without Slots



Figure 20b. Two Typical LT1460S8-2.5s, Horizontal Orientation Without Slots



Figure 21a. Same Two LT1460S8-2.5s in Figure 16a, but with Slots



Figure 21b. Same Two LT1460S8-2.5s in Figure 16b, but with Slots

SIMPLIFIED SCHEMATIC



PACKAGE DESCRIPTION

S3 Package
3-Lead Plastic SOT-23
 (Reference LTC DWG # 05-08-1631)

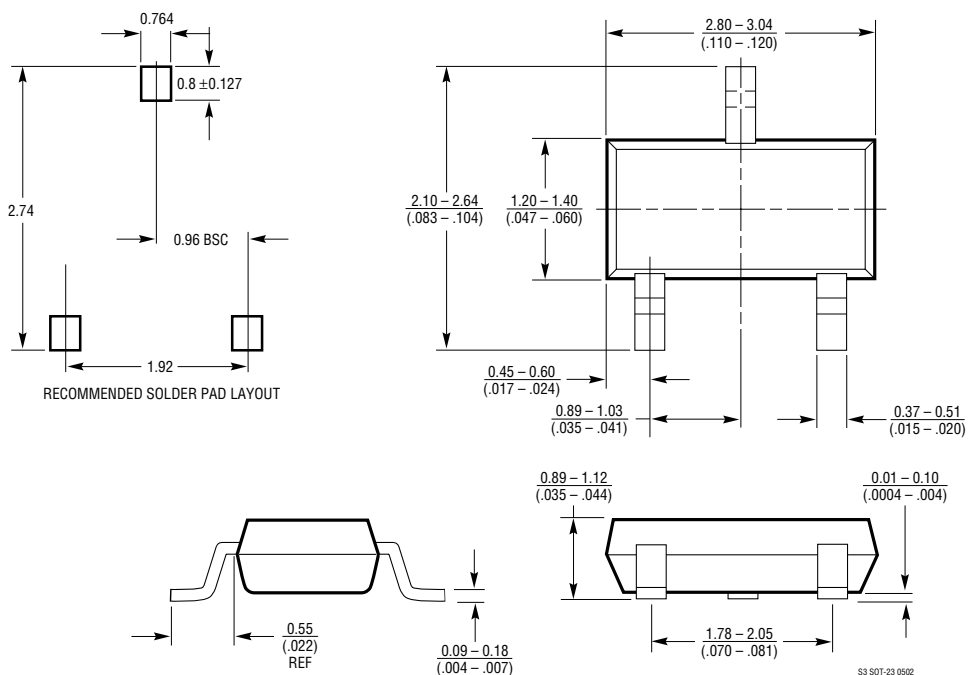

- NOTE:
1. CONTROLLING DIMENSION: MILLIMETERS
 2. DIMENSIONS ARE IN $\frac{\text{MILLIMETERS}}{\text{INCHES}}$
 3. DRAWING NOT TO SCALE
 4. DIMENSIONS ARE INCLUSIVE OF PLATING
 5. DIMENSIONS ARE EXCLUSIVE OF MOLD FLASH AND METAL BURR
 6. MOLD FLASH SHALL NOT EXCEED .254mm
 7. PACKAGE JEDEC REFERENCE IS TO-236 VARIATION AB

PACKAGE DESCRIPTION

N8 Package
8-Lead PDIP (Narrow .300 Inch)
 (Reference LTC DWG # 05-08-1510)



NOTE:
 1. DIMENSIONS ARE $\frac{\text{INCHES}}{\text{MILLIMETERS}}$
 *THESE DIMENSIONS DO NOT INCLUDE MOLD FLASH OR PROTRUSIONS.
 MOLD FLASH OR PROTRUSIONS SHALL NOT EXCEED .010 INCH (0.254mm)

S8 Package
8-Lead Plastic Small Outline (Narrow .150 Inch)
 (Reference LTC DWG # 05-08-1610)

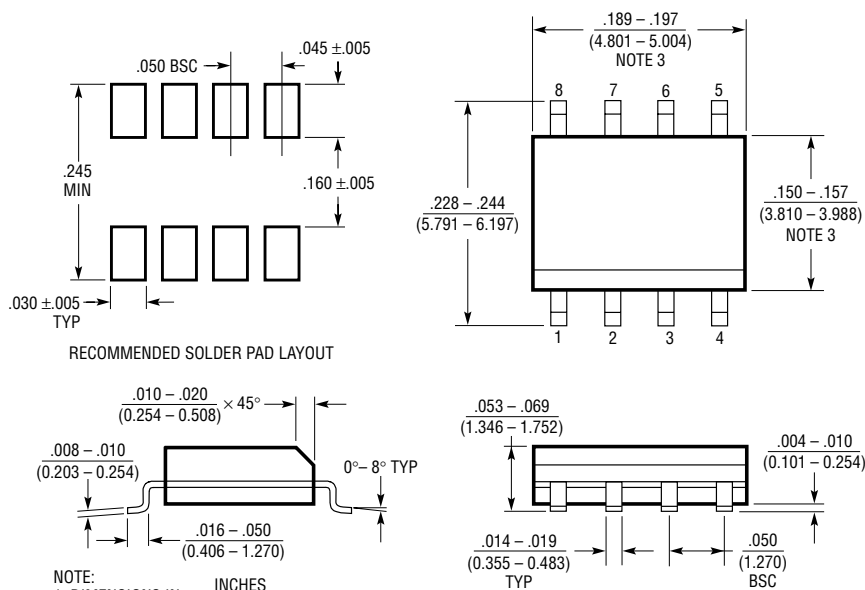

RECOMMENDED SOLDER PAD LAYOUT

NOTE:
 1. DIMENSIONS IN $\frac{\text{INCHES}}{\text{MILLIMETERS}}$
 2. DRAWING NOT TO SCALE
 3. THESE DIMENSIONS DO NOT INCLUDE MOLD FLASH OR PROTRUSIONS.
 MOLD FLASH OR PROTRUSIONS SHALL NOT EXCEED .006" (0.15mm)

S08 0303

PACKAGE DESCRIPTION

MS8 Package 8-Lead Plastic MSOP

(Reference LTC DWG # 05-08-1660 Rev F)

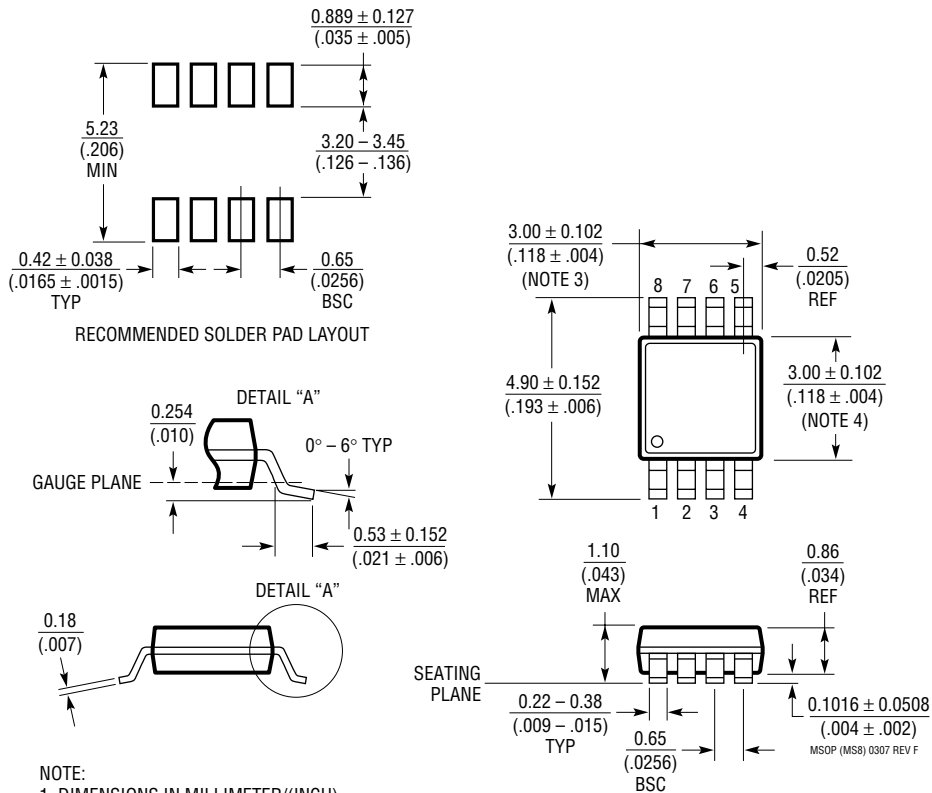

- NOTE:
1. DIMENSIONS IN MILLIMETER/(INCH)
 2. DRAWING NOT TO SCALE
 3. DIMENSION DOES NOT INCLUDE MOLD FLASH, PROTRUSIONS OR GATE BURRS.
MOLD FLASH, PROTRUSIONS OR GATE BURRS SHALL NOT EXCEED 0.152mm (.006") PER SIDE
 4. DIMENSION DOES NOT INCLUDE INTERLEAD FLASH OR PROTRUSIONS.
INTERLEAD FLASH OR PROTRUSIONS SHALL NOT EXCEED 0.152mm (.006") PER SIDE
 5. LEAD COPLANARITY (BOTTOM OF LEADS AFTER FORMING) SHALL BE 0.102mm (.004") MAX

PACKAGE DESCRIPTION

Z Package
3-Lead Plastic TO-92 (Similar to TO-226)
 (Reference LTC DWG # 05-08-1410 Rev C)

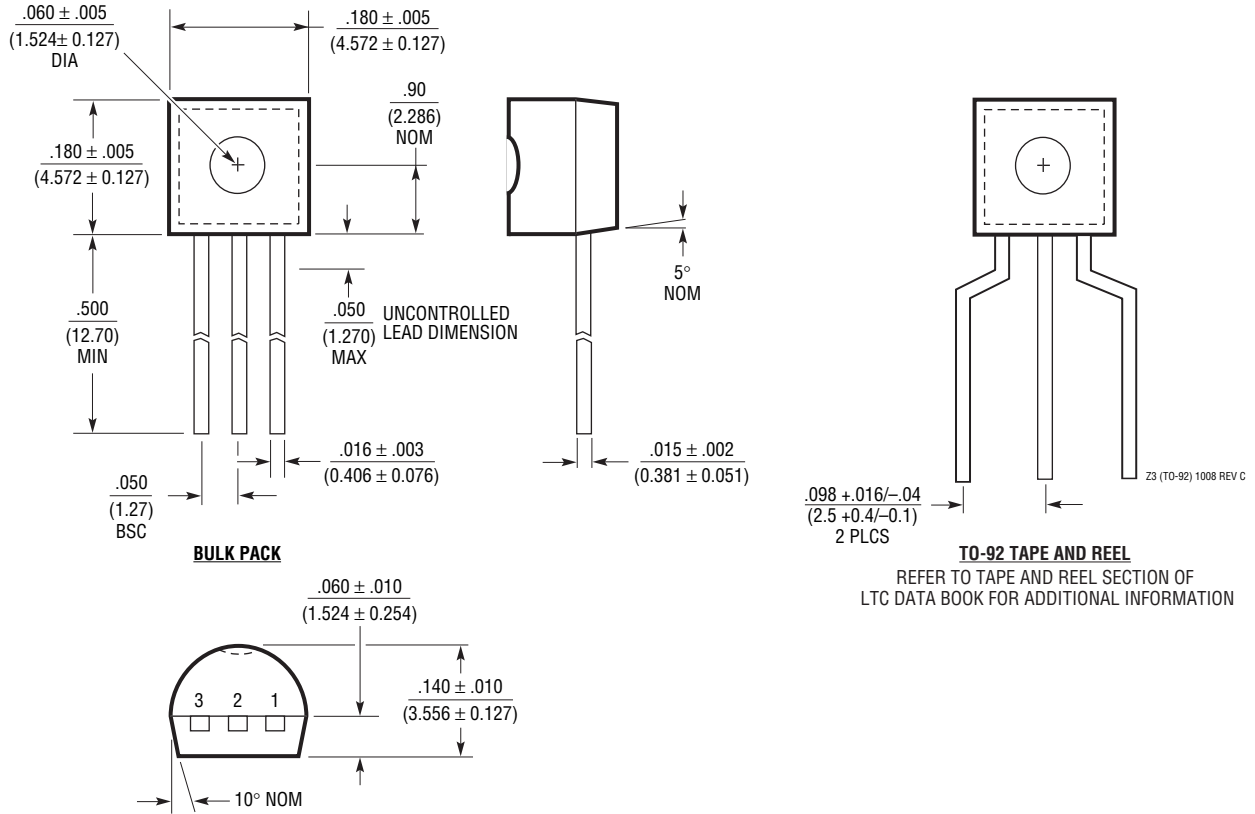

REVISION HISTORY (Revision history begins at Rev C)

REV	DATE	DESCRIPTION	PAGE NUMBER
C	3/10	Change θ_{JA} on S3 Package from 325°C/W to 228°C/W	2

TYPICAL APPLICATIONS

Handling Higher Load Currents



*SELECT R1 TO DELIVER 80% OF TYPICAL LOAD CURRENT. LT1460 WILL THEN SOURCE AS NECESSARY TO MAINTAIN PROPER OUTPUT. DO NOT REMOVE LOAD AS OUTPUT WILL BE DRIVEN UNREGULATED HIGH. LINE REGULATION IS DEGRADED IN THIS APPLICATION

$$R1 = \frac{V^+ - V_{OUT}}{40mA}$$

1460 TA03

Boosted Output Current with No Current Limit



1460 TA04

Boosted Output Current with Current Limit



* GLOWS IN CURRENT LIMIT, DO NOT OMIT

1460 TA05

RELATED PARTS

PART NUMBER	DESCRIPTION	COMMENTS
LT1019	Precision Bandgap Reference	0.05% Max, 5ppm/°C Max
LT1027	Precision 5V Reference	0.02%, 2ppm/°C Max
LT1236	Precision Low Noise Reference	0.05% Max, 5ppm/°C Max, SO Package
LT1461	Micropower Precision Low Dropout	0.04% Max, 3ppm/°C Max, 50mA Output Current
LT1634	Micropower Precision Shunt Reference 1.25V, 2.5V Output	0.05%, 25ppm/°C Max
LT1790	Micropower Precision Series References	0.05% Max, 10ppm/°C Max, 60µA Supply, SOT23 Package
LTC®1798	Micropower Low Dropout Reference, Fixed or Adjustable	0.15% Max, 40ppm/°C, 6.5µA Max Supply Current
LTC6652	Low Drift Low Noise Buffered Reference	0.05% Accuracy, 5ppm/°C Drift, 2.1ppm (0.1Hz to 10Hz) Noise
LT6660	Tiny Micropower Precision Series References	0.075% Max, 10ppm/°C Max, 20mA Output, 2mm × 2mm DFN Package



Стандарт Электрон Связь

Мы молодая и активно развивающаяся компания в области поставок электронных компонентов. Мы поставляем электронные компоненты отечественного и импортного производства напрямую от производителей и с крупнейших складов мира.

Благодаря сотрудничеству с мировыми поставщиками мы осуществляем комплексные и плановые поставки широчайшего спектра электронных компонентов.

Собственная эффективная логистика и склад в обеспечивает надежную поставку продукции в точно указанные сроки по всей России.

Мы осуществляем техническую поддержку нашим клиентам и предпродажную проверку качества продукции. На все поставляемые продукты мы предоставляем гарантию .

Осуществляем поставки продукции под контролем ВП МО РФ на предприятия военно-промышленного комплекса России , а также работаем в рамках 275 ФЗ с открытием отдельных счетов в уполномоченном банке. Система менеджмента качества компании соответствует требованиям ГОСТ ISO 9001.

Минимальные сроки поставки, гибкие цены, неограниченный ассортимент и индивидуальный подход к клиентам являются основой для выстраивания долгосрочного и эффективного сотрудничества с предприятиями радиоэлектронной промышленности, предприятиями ВПК и научно-исследовательскими институтами России.

С нами вы становитесь еще успешнее!

Наши контакты:

Телефон: +7 812 627 14 35

Электронная почта: sales@st-electron.ru

Адрес: 198099, Санкт-Петербург,
Промышленная ул, дом № 19, литера Н,
помещение 100-Н Офис 331