

Autonomous Audio Headset Switch with Reduced GND Switch R_{ON} and FM Capability

Check for Samples: [TS3A226E](#)

FEATURES

- Ground FET Switches (60mΩ typical)
- Autonomous Detection of Headset Types: 3-Poles or 4-Poles (with MIC on SLEEVE or RING2)
- Microphone Line Switches
- Supports FM Signal Transmission Through the Ground FETs
- Reduction of Click/Pop Noise
- VDD Range: 2.6 V – 4.7 V
- THD (Mic): 0.002% Typical
- Low Current Consumption: 6.5-μA Typical
- ±8kV Contract Discharge (IEC 61000-4-2) ESD Performance on SLEEVE and RING2 Pins

APPLICATIONS

- Mobile Phones / Tablet PCs
- Notebook/Ultrabook Computers

DESCRIPTION

The TS3A226E is an audio headset switch that detects 3- or 4-pole 3.5mm accessories. For a 4-pole accessory with a microphone, the TS3A226E also detects the MIC location and routes the microphone and ground signals automatically. The ground signal is routed through a pair of low-impedance ground FETs (60mΩ typical), resulting minimal impact on audio cross-talk performance. The autonomous detection feature allows end users to plug in accessories with different audio pole configurations into the mobile device and have them operate properly with no added software control and complexity. The ground FETs of the device are designed to allow FM signal pass-through, making it possible to use the ground line of the headset as an FM antenna in mobile audio application.

The TS3A226E is packaged within a 1.2mm × 1.2mm WCSP package, making it suitable for use in mobile application.

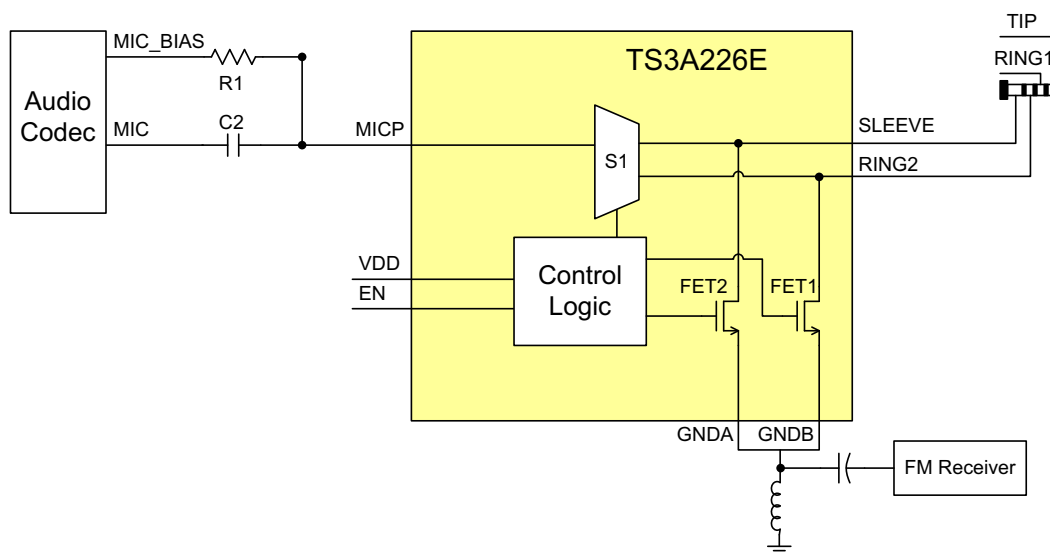

Figure 1. Typical Application Diagram

ORDERING INFORMATION

T _A	PACKAGE ⁽¹⁾⁽²⁾		ORDERABLE PART NUMBER	TOP-SIDE MARKING
-40°C to 85°C	YFF- WCSP	Tape and reel	TS3A226EYFFR	YP226E

- (1) Package drawings, thermal data, and symbolization are available at www.ti.com/packaging.
- (2) For the most current package and ordering information, see the Package Option Addendum at the end of this document, or see the TI web site at www.ti.com.



Please be aware that an important notice concerning availability, standard warranty, and use in critical applications of Texas Instruments semiconductor products and disclaimers thereto appears at the end of this data sheet.

TS3A226E

SCDS340 –MARCH 2013

www.ti.com



These devices have limited built-in ESD protection. The leads should be shorted together or the device placed in conductive foam during storage or handling to prevent electrostatic damage to the MOS gates.

PACKAGE; YFF-WCSP

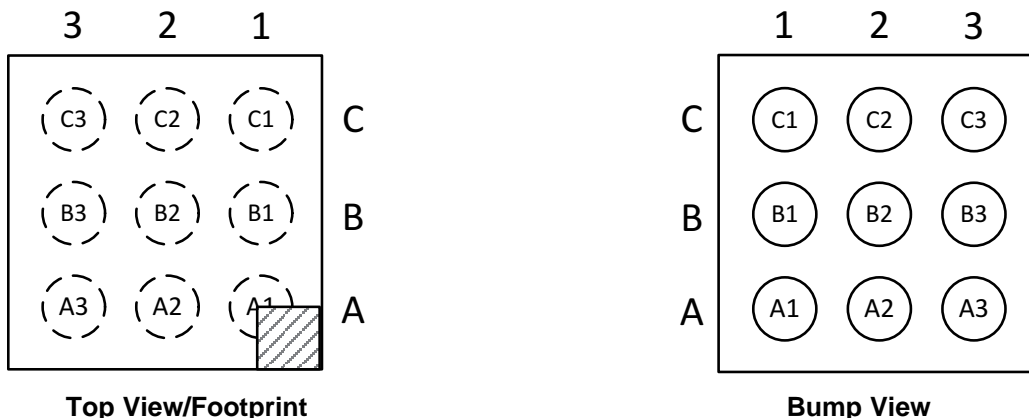

Die Size: 1.2mm x1.2mm
Bump Size: 0.25mm
Bump Pitch: 0.4mm

TS3A226E Pin Mapping (Top View)

	3	2	1
C	GND	TIP	EN
B	SLEEVE	GNDA	MICp
A	RING2	GNDB	VDD

PIN FUNCTIONS

NUMBER	PIN		DESCRIPTION
	NAME	TYPE	
A1	VDD	Supply	Power supply for the chip.
A2	GNDB	Ground	FET2 ground reference.
A3	RING2	I/O	Connected to the RING2 segment of the jack. The pin will be routed automatically by TS3A226E to either MICp or GNDB depending on the type of accessory.
B1	MICp	I/O	Microphone signal connection to codec. Microphone bias should be fed into this pin.
B2	GNDA	Ground	FET1 ground reference.
B3	SLEEVE	I/O	Connected to the SLEEVE segment of the jack. The pin will be routed automatically by TS3A226E to either MICp or GNDA depending on the type of accessory.
C1	EN	Input	A rising edge triggers the detection sequence. This pin can be connected to the headset jack to allow automatic pull-up to supply after headset insertion.
C2	TIP	I/O	Connected to the TIP segment of the headphone jack.
C3	GND	Ground	Chip ground reference.

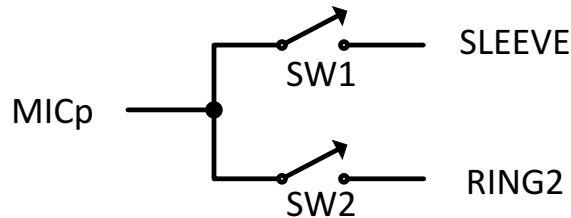
S1 MUX DETAIL

Figure 2. S1 Mux Detail
FUNCTIONAL TABLES: INTERNAL SWITCHES

EN	Accessory Type	Accessory Configuration	SW1	SW2	FET1	FET2
0	N/A	—	High Z	High Z	High Z	High Z
1	TRS 3-pole Headphone or Speaker	TIP = Audio Left Ring = Audio Right Sleeve = Ground	High Z	High Z	On	On
1	TRRS 4-pole Headphone	TIP = Audio Left Ring1 = Audio Right Ring2 = Ground Sleeve = Microphone	On	High Z	High Z	On
1	TRRS 4-pole Headphone	TIP = Audio Left Ring1 = Audio Right Ring2 = Microphone Sleeve = Ground	High Z	On	On	High Z
1	N/A	—	High Z	High Z	High Z	High Z

ABSOLUTE MAXIMUM RATINGS

 over operating free-air temperature range (unless otherwise noted)⁽¹⁾

		VALUE	UNIT
V _I	Voltage range on VDD ⁽²⁾	-0.3 to 5	V
	Voltage range on EN, MICP, RING2, SLEEVE, TIP ⁽²⁾	-0.3 to V _{DD} +0.5	V
T _A	Operating ambient temperature range ⁽³⁾	-40 to 85	°C
T _{J (MAX)}	Maximum operating junction temperature	125	°C
T _{stg}	Storage temperature range	-65 to 150	°C
ESD rating	Machine model (JESD 22 A115)	100	V
	Charge device model (JESD 22 C101)	500	V
	Human body model (JESD 22 A114)	2	kV
	Contact discharge on RING2, SLEEVE, TIP (IEC 61000-4-2)	8	kV

- (1) Stresses beyond those listed under absolute maximum ratings may cause permanent damage to the device. These are stress ratings only, and functional operation of the device at these or any other conditions beyond those indicated under recommended operating conditions is not implied. Exposure to absolute-maximum-rated conditions for extended periods may affect device reliability.
- (2) All voltage values are with respect to network ground terminal.
- (3) In applications where high power dissipation and/or poor package thermal resistance is present, the maximum ambient temperature may have to be derated. Maximum ambient temperature [T_{A(max)}] is dependent on the maximum operating junction temperature [T_{J(max)}], the maximum power dissipation of the device in the application [P_{D(max)}], and the junction-to-ambient thermal resistance of the part/package in the application (θ_{JA}), as given by the following equation: T_{A(max)} = T_{J(max)} - (θ_{JA} × P_{D(max)})

TS3A226E

SCDS340 –MARCH 2013

www.ti.com

RECOMMENDED OPERATING CONDITIONS

over operating free-air temperature range (unless otherwise noted)

		MIN	MAX	UNIT	
V _{DD}	Supply voltage range	2.6	4.5	V	
V _{IO}	Input/Output voltage range (EN, MICP, RING2, SLEEVE, TIP)	0	V _{DD}	V	
V _{IH}	Input Logic High for EN	V _{DD} = 2.6 V	1.16	V _{DD}	V
		V _{DD} = 3.3 V	1.24	V _{DD}	
		V _{DD} = 4.5 V	1.48	V _{DD}	
V _{IL}	Input Logic Low for EN	V _{DD} = 2.6 V	0	0.19	V
		V _{DD} = 3.3 V	0	0.3	
		V _{DD} = 4.5 V	0	0.5	
T _A	Operating temperature range	-40	85	°C	

KEY ELECTRICAL CHARACTERISTICS

Unless otherwise noted the specification applies over the V_{DD} range and operating junction temperature $-40^{\circ}\text{C} \leq T_A \leq 70^{\circ}\text{C}$. Typical values are for V_{DD} = 3.3V and T_J = 25°C.

PARAMETER	TEST CONDITIONS	MIN	TYP	MAX	UNIT	
V _{DD}	Input Voltage Range	2.6	3.3	4.5	V	
I _{DD}	Quiescent Current	V _{DD} = 4.5 V, V _{MICP} = 1.8 V to V _{DD}		6.5	14	μA
SWITCH RESISTANCE						
R _{F1}	FET1 On Resistance	V _{DD} = 2.6 V, V _{GND} = 0 V, I _{GND} = 10 mA		60	85	mΩ
R _{F2}	FET2 On Resistance			60	85	
R _{SW1}	SW1 On Resistance	V _{DD} = 2.6 V, V _{SLEEVE/RING2} = 0 V to 2.6 V, I _{MIC} = ±10 mA		10.5		Ω
R _{SW2}	SW2 On Resistance			10.5		
SWITCH LEAKAGE CURRENT						
I _{OFF-0.1}	FET1 and FET2 off leakage	V _{IN} = 0 V to 2.6 V, V _{OUT} = 0 V, V _{DD} = 4.5 V		1		μA
I _{OFF-10}	SW1, SW2 off leakage			1		
I _{ON-10}	SW1, SW2 on leakage			1		
SWITCH DYNAMIC CHARACTERISTICS						
BW _{F1}	FET1 Bandwidth	V = 60 mV _{PP} , I _{bias} = 10 mA		160	200	MHz
BW _{F2}	FET2 Bandwidth			160	200	
PSR ₂₁₇	Power Supply Rejection, R _L = 50 Ω	V = 200 mV _{PP} , f = 217 Hz		-110		dB
PSR _{1k}		V = 200 mV _{PP} , f = 1 kHz		-100		
PSR _{20k}		V = 200 mV _{PP} , f = 20 kHz		-85		
ISO _{S1}	SLEEVE or RING2 to MICP Isolation	V = 200 mV _{PP} , f = 20 kHz, R _L = 50 Ω		-80		dB
SEP _{S1}	SLEEVE to RING2 Separation	V = 200 mV _{PP} , f = 20 kHz, R _L = 50 Ω (see Figure 5)		-80		dB
THD ₁₀	Total Harmonic Distortion	V = 10 mV _{PP} , f = 20-20 kHz, R _S = 600 Ω		0.01%		
THD ₂₀₀		V = 200 mV _{PP} , f = 20-20 kHz, R _S = 600 Ω		0.002%		

TYPICAL CHARACTERISTICS

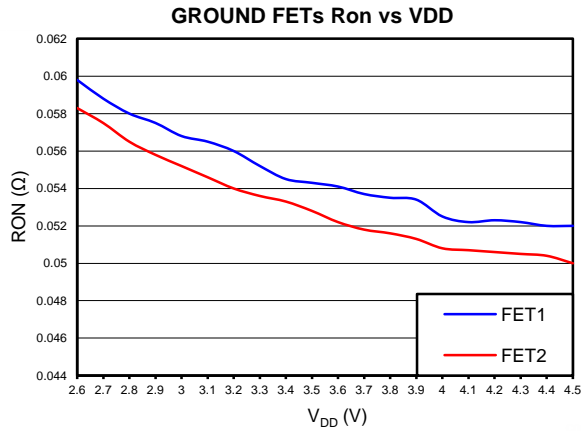

Figure 3.

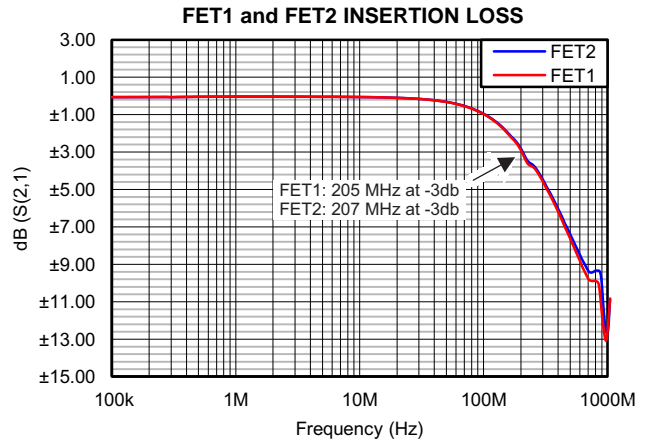

Figure 4.

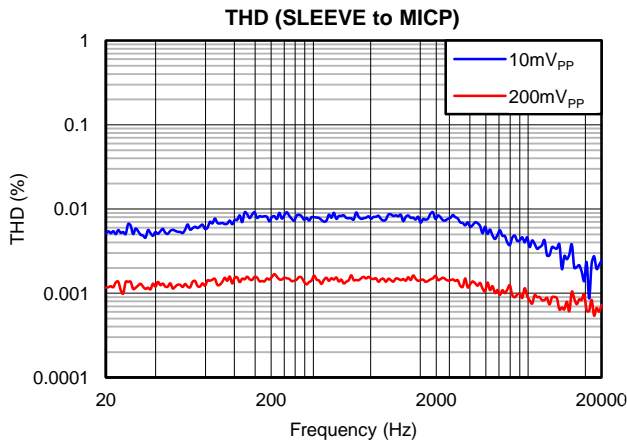

Figure 5.

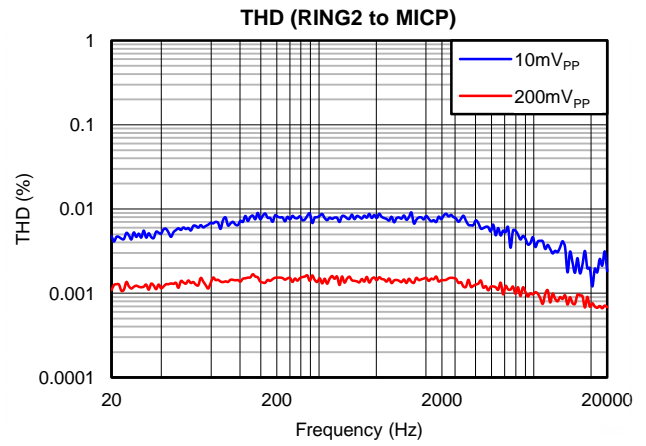

Figure 6.

PACKAGING INFORMATION

Orderable Device	Status (1)	Package Type	Package Drawing	Pins	Package Qty	Eco Plan (2)	Lead/Ball Finish (6)	MSL Peak Temp (3)	Op Temp (°C)	Device Marking (4/5)	Samples
TS3A226EYFFR	OBSOLETE	DSBGA	YFF	9		TBD	Call TI	Call TI	-40 to 85	YP2 26E	

(1) The marketing status values are defined as follows:

ACTIVE: Product device recommended for new designs.

LIFEBUY: TI has announced that the device will be discontinued, and a lifetime-buy period is in effect.

NRND: Not recommended for new designs. Device is in production to support existing customers, but TI does not recommend using this part in a new design.

PREVIEW: Device has been announced but is not in production. Samples may or may not be available.

OBSOLETE: TI has discontinued the production of the device.

(2) Eco Plan - The planned eco-friendly classification: Pb-Free (RoHS), Pb-Free (RoHS Exempt), or Green (RoHS & no Sb/Br) - please check <http://www.ti.com/productcontent> for the latest availability information and additional product content details.

TBD: The Pb-Free/Green conversion plan has not been defined.

Pb-Free (RoHS): TI's terms "Lead-Free" or "Pb-Free" mean semiconductor products that are compatible with the current RoHS requirements for all 6 substances, including the requirement that lead not exceed 0.1% by weight in homogeneous materials. Where designed to be soldered at high temperatures, TI Pb-Free products are suitable for use in specified lead-free processes.

Pb-Free (RoHS Exempt): This component has a RoHS exemption for either 1) lead-based flip-chip solder bumps used between the die and package, or 2) lead-based die adhesive used between the die and leadframe. The component is otherwise considered Pb-Free (RoHS compatible) as defined above.

Green (RoHS & no Sb/Br): TI defines "Green" to mean Pb-Free (RoHS compatible), and free of Bromine (Br) and Antimony (Sb) based flame retardants (Br or Sb do not exceed 0.1% by weight in homogeneous material)

(3) MSL, Peak Temp. - The Moisture Sensitivity Level rating according to the JEDEC industry standard classifications, and peak solder temperature.

(4) There may be additional marking, which relates to the logo, the lot trace code information, or the environmental category on the device.

(5) Multiple Device Markings will be inside parentheses. Only one Device Marking contained in parentheses and separated by a "~" will appear on a device. If a line is indented then it is a continuation of the previous line and the two combined represent the entire Device Marking for that device.

(6) Lead/Ball Finish - Orderable Devices may have multiple material finish options. Finish options are separated by a vertical ruled line. Lead/Ball Finish values may wrap to two lines if the finish value exceeds the maximum column width.

Important Information and Disclaimer: The information provided on this page represents TI's knowledge and belief as of the date that it is provided. TI bases its knowledge and belief on information provided by third parties, and makes no representation or warranty as to the accuracy of such information. Efforts are underway to better integrate information from third parties. TI has taken and continues to take reasonable steps to provide representative and accurate information but may not have conducted destructive testing or chemical analysis on incoming materials and chemicals. TI and TI suppliers consider certain information to be proprietary, and thus CAS numbers and other limited information may not be available for release.

In no event shall TI's liability arising out of such information exceed the total purchase price of the TI part(s) at issue in this document sold by TI to Customer on an annual basis.

MECHANICAL DATA

YFF (S-XBGA-N9)

DIE-SIZE BALL GRID ARRAY

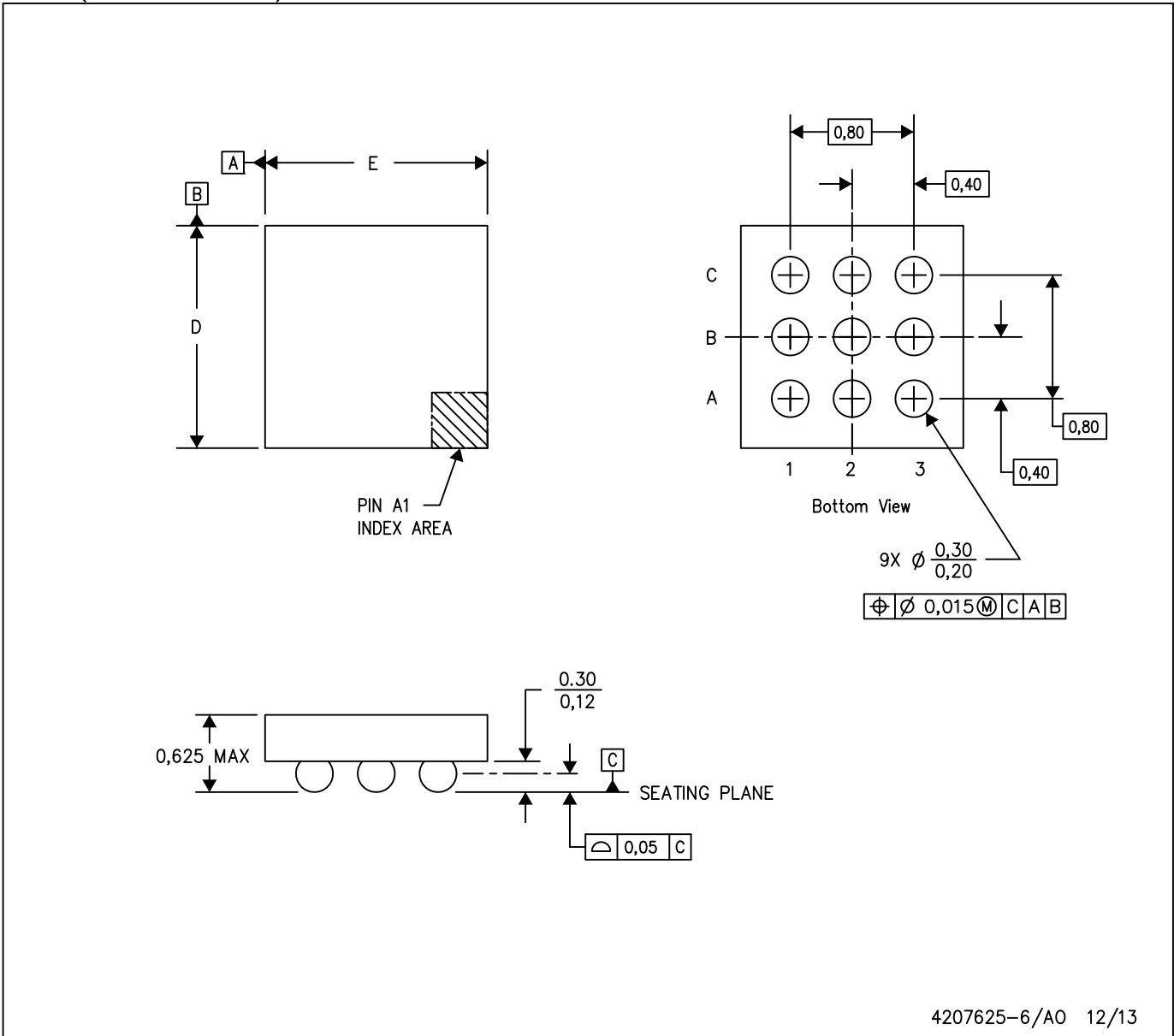

- NOTES: A. All linear dimensions are in millimeters. Dimensioning and tolerancing per ASME Y14.5M-1994.
 B. This drawing is subject to change without notice.
 C. NanoFree™ package configuration.

NanoFree is a trademark of Texas Instruments.

IMPORTANT NOTICE

Texas Instruments Incorporated and its subsidiaries (TI) reserve the right to make corrections, enhancements, improvements and other changes to its semiconductor products and services per JESD46, latest issue, and to discontinue any product or service per JESD48, latest issue. Buyers should obtain the latest relevant information before placing orders and should verify that such information is current and complete. All semiconductor products (also referred to herein as "components") are sold subject to TI's terms and conditions of sale supplied at the time of order acknowledgment.

TI warrants performance of its components to the specifications applicable at the time of sale, in accordance with the warranty in TI's terms and conditions of sale of semiconductor products. Testing and other quality control techniques are used to the extent TI deems necessary to support this warranty. Except where mandated by applicable law, testing of all parameters of each component is not necessarily performed.

TI assumes no liability for applications assistance or the design of Buyers' products. Buyers are responsible for their products and applications using TI components. To minimize the risks associated with Buyers' products and applications, Buyers should provide adequate design and operating safeguards.

TI does not warrant or represent that any license, either express or implied, is granted under any patent right, copyright, mask work right, or other intellectual property right relating to any combination, machine, or process in which TI components or services are used. Information published by TI regarding third-party products or services does not constitute a license to use such products or services or a warranty or endorsement thereof. Use of such information may require a license from a third party under the patents or other intellectual property of the third party, or a license from TI under the patents or other intellectual property of TI.

Reproduction of significant portions of TI information in TI data books or data sheets is permissible only if reproduction is without alteration and is accompanied by all associated warranties, conditions, limitations, and notices. TI is not responsible or liable for such altered documentation. Information of third parties may be subject to additional restrictions.

Resale of TI components or services with statements different from or beyond the parameters stated by TI for that component or service voids all express and any implied warranties for the associated TI component or service and is an unfair and deceptive business practice. TI is not responsible or liable for any such statements.

Buyer acknowledges and agrees that it is solely responsible for compliance with all legal, regulatory and safety-related requirements concerning its products, and any use of TI components in its applications, notwithstanding any applications-related information or support that may be provided by TI. Buyer represents and agrees that it has all the necessary expertise to create and implement safeguards which anticipate dangerous consequences of failures, monitor failures and their consequences, lessen the likelihood of failures that might cause harm and take appropriate remedial actions. Buyer will fully indemnify TI and its representatives against any damages arising out of the use of any TI components in safety-critical applications.

In some cases, TI components may be promoted specifically to facilitate safety-related applications. With such components, TI's goal is to help enable customers to design and create their own end-product solutions that meet applicable functional safety standards and requirements. Nonetheless, such components are subject to these terms.

No TI components are authorized for use in FDA Class III (or similar life-critical medical equipment) unless authorized officers of the parties have executed a special agreement specifically governing such use.

Only those TI components which TI has specifically designated as military grade or "enhanced plastic" are designed and intended for use in military/aerospace applications or environments. Buyer acknowledges and agrees that any military or aerospace use of TI components which have **not** been so designated is solely at the Buyer's risk, and that Buyer is solely responsible for compliance with all legal and regulatory requirements in connection with such use.

TI has specifically designated certain components as meeting ISO/TS16949 requirements, mainly for automotive use. In any case of use of non-designated products, TI will not be responsible for any failure to meet ISO/TS16949.

Products

Audio	www.ti.com/audio
Amplifiers	amplifier.ti.com
Data Converters	dataconverter.ti.com
DLP® Products	www.dlp.com
DSP	dsp.ti.com
Clocks and Timers	www.ti.com/clocks
Interface	interface.ti.com
Logic	logic.ti.com
Power Mgmt	power.ti.com
Microcontrollers	microcontroller.ti.com
RFID	www.ti-rfid.com
OMAP Applications Processors	www.ti.com/omap
Wireless Connectivity	www.ti.com/wirelessconnectivity

Applications

Automotive and Transportation	www.ti.com/automotive
Communications and Telecom	www.ti.com/communications
Computers and Peripherals	www.ti.com/computers
Consumer Electronics	www.ti.com/consumer-apps
Energy and Lighting	www.ti.com/energy
Industrial	www.ti.com/industrial
Medical	www.ti.com/medical
Security	www.ti.com/security
Space, Avionics and Defense	www.ti.com/space-avionics-defense
Video and Imaging	www.ti.com/video

TI E2E Community

e2e.ti.com



Стандарт Электрон Связь

Мы молодая и активно развивающаяся компания в области поставок электронных компонентов. Мы поставляем электронные компоненты отечественного и импортного производства напрямую от производителей и с крупнейших складов мира.

Благодаря сотрудничеству с мировыми поставщиками мы осуществляем комплексные и плановые поставки широчайшего спектра электронных компонентов.

Собственная эффективная логистика и склад в обеспечивает надежную поставку продукции в точно указанные сроки по всей России.

Мы осуществляем техническую поддержку нашим клиентам и предпродажную проверку качества продукции. На все поставляемые продукты мы предоставляем гарантию .

Осуществляем поставки продукции под контролем ВП МО РФ на предприятия военно-промышленного комплекса России , а также работаем в рамках 275 ФЗ с открытием отдельных счетов в уполномоченном банке. Система менеджмента качества компании соответствует требованиям ГОСТ ISO 9001.

Минимальные сроки поставки, гибкие цены, неограниченный ассортимент и индивидуальный подход к клиентам являются основой для выстраивания долгосрочного и эффективного сотрудничества с предприятиями радиоэлектронной промышленности, предприятиями ВПК и научно-исследовательскими институтами России.

С нами вы становитесь еще успешнее!

Наши контакты:

Телефон: +7 812 627 14 35

Электронная почта: sales@st-electron.ru

Адрес: 198099, Санкт-Петербург,
Промышленная ул, дом № 19, литера Н,
помещение 100-Н Офис 331