

**Features**

- Epitaxial Planar Die Construction
- Complementary NPN Type Available (MMST3904)
- Ultra-Small Surface Mount Package
- **Lead Free/RoHS Compliant (Note 2)**
- **"Green" Device (Notes 3 and 4)**

**Mechanical Data**

- Case: SOT-323
- Case Material: Molded Plastic, "Green" Molding Compound, Note 4. UL Flammability Classification Rating 94V-0
- Moisture Sensitivity: Level 1 per J-STD-020C
- Terminals: Solderable per MIL-STD-202, Method 208
- Terminal Connections: See Diagram
- Lead Free Plating (Matte Tin Finish annealed over Alloy 42 leadframe).
- Marking Information: K5N - See Page 4
- Ordering & Date Code Information: See Page 4
- Weight: 0.006 grams (approximate)

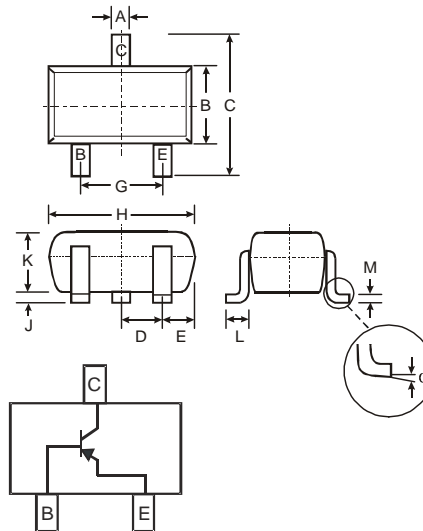

SOT-323		
Dim	Min	Max
A	0.25	0.40
B	1.15	1.35
C	2.00	2.20
D	0.65 Nominal	
E	0.30	0.40
G	1.20	1.40
H	1.80	2.20
J	0.0	0.10
K	0.90	1.00
L	0.25	0.40
M	0.10	0.18
$\alpha$	0°	8°
All Dimensions in mm		

**Maximum Ratings** @T<sub>A</sub> = 25°C unless otherwise specified

Characteristic	Symbol	Value	Unit
Collector-Base Voltage	V <sub>CB0</sub>	-40	V
Collector-Emitter Voltage	V <sub>CEO</sub>	-40	V
Emitter-Base Voltage	V <sub>EBO</sub>	-5.0	V
Collector Current - Continuous (Note 1)	I <sub>C</sub>	-200	mA
Power Dissipation (Note 1)	P <sub>d</sub>	200	mW
Thermal Resistance, Junction to Ambient (Note 1)	R <sub>θJA</sub>	625	°C/W
Operating and Storage Temperature Range	T <sub>j</sub> , T <sub>STG</sub>	-55 to +150	°C

- Notes:
1. Device mounted on FR-4 PCB, 1 inch x 0.85 inch x 0.062 inch; pad layout as shown on Diodes Inc. suggested pad layout document AP02001, which can be found on our website at <http://www.diodes.com/datasheets/ap02001.pdf>.
  2. No purposefully added lead.
  3. Diodes Inc.'s "Green" policy can be found on our website at [http://www.diodes.com/products/lead\\_free/index.php](http://www.diodes.com/products/lead_free/index.php).
  4. Product manufactured with Date Code 0627 (week 27, 2006) and newer are built with Green Molding Compound. Product manufactured prior to Date Code 0627 are built with Non-Green Molding Compound and may contain Halogens or Sb2O3 Fire Retardants.

## Electrical Characteristics @T<sub>A</sub> = 25°C unless otherwise specified

Characteristic	Symbol	Min	Max	Unit	Test Condition
<b>OFF CHARACTERISTICS (Note 5)</b>					
Collector-Base Breakdown Voltage	V <sub>(BR)CBO</sub>	-40	—	V	I <sub>C</sub> = -10μA, I <sub>E</sub> = 0
Collector-Emitter Breakdown Voltage	V <sub>(BR)CEO</sub>	-40	—	V	I <sub>C</sub> = -1.0mA, I <sub>B</sub> = 0
Emitter-Base Breakdown Voltage	V <sub>(BR)EBO</sub>	-5.0	—	V	I <sub>E</sub> = -10μA, I <sub>C</sub> = 0
Collector Cutoff Current	I <sub>CEX</sub>	—	-50	nA	V <sub>CE</sub> = -30V, V <sub>EB(OFF)</sub> = -3.0V
Base Cutoff Current	I <sub>BL</sub>	—	-50	nA	V <sub>CE</sub> = -30V, V <sub>EB(OFF)</sub> = -3.0V
<b>ON CHARACTERISTICS (Note 5)</b>					
DC Current Gain	h <sub>FE</sub>	60	—	—	I <sub>C</sub> = -100μA, V <sub>CE</sub> = -1.0V
		80	—		I <sub>C</sub> = -1.0mA, V <sub>CE</sub> = -1.0V
		100	300		I <sub>C</sub> = -10mA, V <sub>CE</sub> = -1.0V
		60	—		I <sub>C</sub> = -50mA, V <sub>CE</sub> = -1.0V
		30	—		I <sub>C</sub> = -100mA, V <sub>CE</sub> = -1.0V
Collector-Emitter Saturation Voltage	V <sub>CE(SAT)</sub>	—	-0.20 -0.30	V	I <sub>C</sub> = -10mA, I <sub>B</sub> = -1.0mA I <sub>C</sub> = -50mA, I <sub>B</sub> = -5.0mA
Base-Emitter Saturation Voltage	V <sub>BE(SAT)</sub>	-0.65 —	-0.85 -0.95	V	I <sub>C</sub> = -10mA, I <sub>B</sub> = -1.0mA I <sub>C</sub> = -50mA, I <sub>B</sub> = -5.0mA
<b>SMALL SIGNAL CHARACTERISTICS</b>					
Output Capacitance	C <sub>obo</sub>	—	4.5	pF	V <sub>CB</sub> = -5.0V, f = 1.0MHz, I <sub>E</sub> = 0
Input Capacitance	C <sub>ibo</sub>	—	10	pF	V <sub>EB</sub> = -0.5V, f = 1.0MHz, I <sub>C</sub> = 0
Input Impedance	h <sub>ie</sub>	2.0	12	kΩ	V <sub>CE</sub> = 1.0V, I <sub>C</sub> = 10mA, f = 1.0kHz
Voltage Feedback Ratio	h <sub>re</sub>	0.1	10	x 10 <sup>-4</sup>	
Small Signal Current Gain	h <sub>fe</sub>	100	400	—	
Output Admittance	h <sub>oe</sub>	3.0	60	μS	
Current Gain-Bandwidth Product	f <sub>T</sub>	300	—	MHz	
Noise Figure	NF	—	4.0	dB	V <sub>CE</sub> = -5.0V, I <sub>C</sub> = -100μA, R <sub>S</sub> = 1.0kΩ, f = 1.0kHz
<b>SWITCHING CHARACTERISTICS</b>					
Delay Time	t <sub>d</sub>	—	35	ns	V <sub>CC</sub> = -3.0V, I <sub>C</sub> = -10mA,
Rise Time	t <sub>r</sub>	—	35	ns	V <sub>BE(off)</sub> = 0.5V, I <sub>B1</sub> = -1.0mA
Storage Time	t <sub>s</sub>	—	225	ns	V <sub>CC</sub> = -3.0V, I <sub>C</sub> = -10mA,
Fall Time	t <sub>f</sub>	—	75	ns	I <sub>B1</sub> = I <sub>B2</sub> = -1.0mA

Note: 5. Short duration pulse test used to minimize self-heating effect.

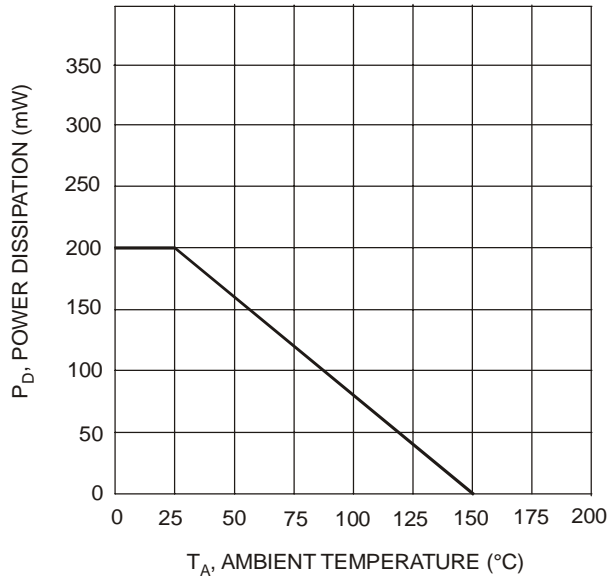

Fig. 1, Max Power Dissipation vs. Ambient Temperature

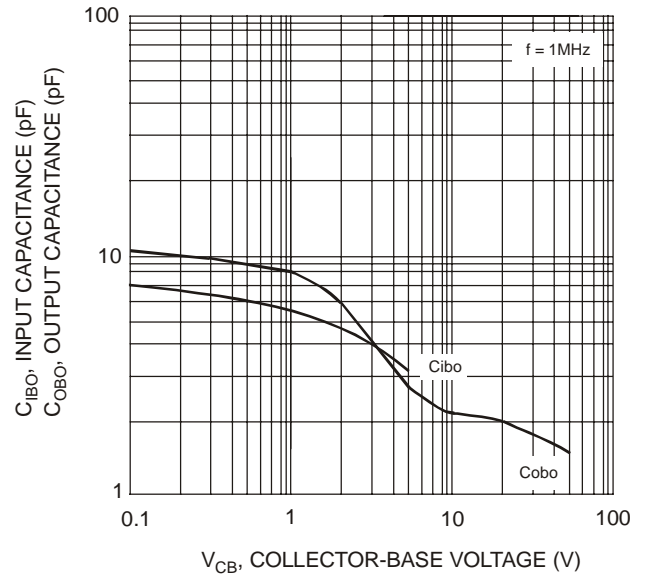

Fig. 2, Input and Output Capacitance vs. Collector-Base Voltage

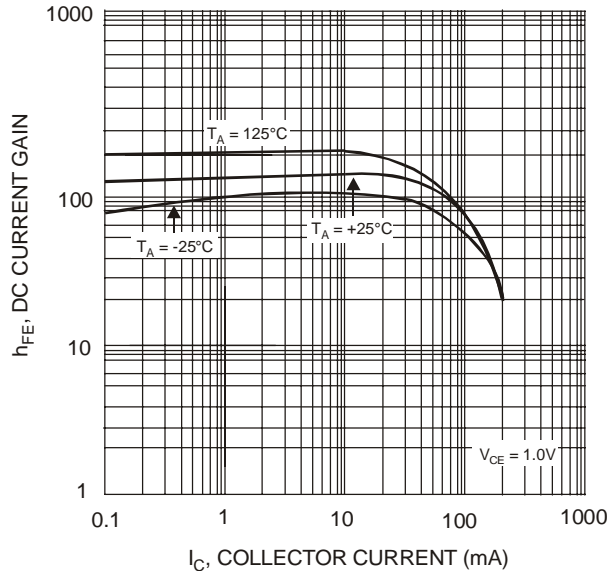

Fig. 3, Typical DC Current Gain vs. Collector Current

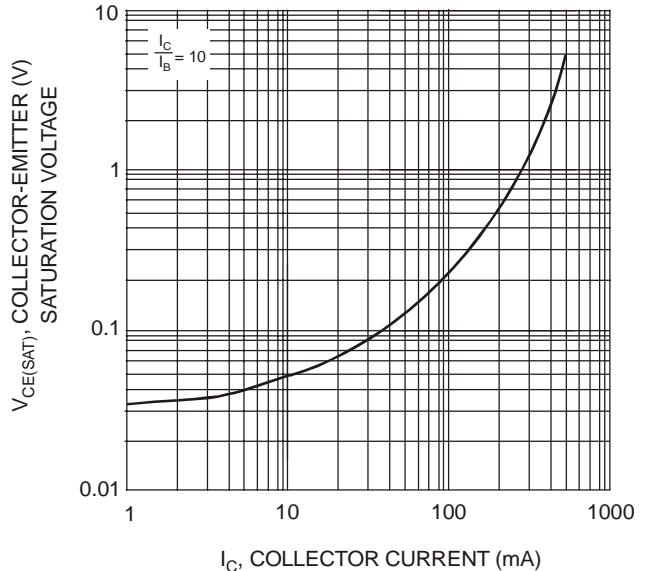

Fig. 4, Typical Collector-Emitter Saturation Voltage vs. Collector Current

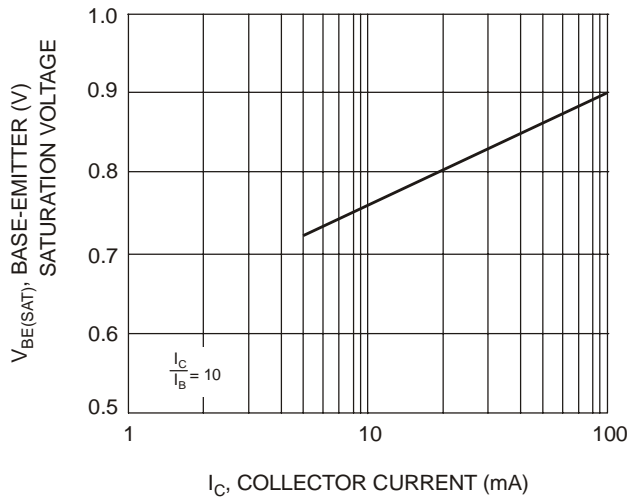

Fig. 5, Typical Base-Emitter Saturation Voltage vs. Collector Current

## Ordering Information (Notes 4 and 6)

Device	Packaging	Shipping
MMST3906-7-F	SOT-323	3000/Tape & Reel

Notes: 6. For packaging details, go to our website at <http://www.diodes.com/datasheets/ap02007.pdf>.

## Marking Information

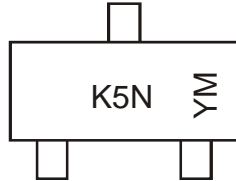

K5N = Product Type Marking Code  
 YM = Date Code Marking  
 Y = Year ex: N = 2002  
 M = Month ex: 9 = September

### Date Code Key

Year	1998	1999	2000	2001	2002	2003	2004	2005	2006	2007	2008	2009	2010	2011	2012
Code	J	K	L	M	N	P	R	S	T	U	V	W	X	Y	Z

Month	Jan	Feb	Mar	Apr	May	Jun	Jul	Aug	Sep	Oct	Nov	Dec
Code	1	2	3	4	5	6	7	8	9	O	N	D

### IMPORTANT NOTICE

Diodes Incorporated and its subsidiaries reserve the right to make modifications, enhancements, improvements, corrections or other changes without further notice to any product herein. Diodes Incorporated does not assume any liability arising out of the application or use of any product described herein; neither does it convey any license under its patent rights, nor the rights of others. The user of products in such applications shall assume all risks of such use and will agree to hold Diodes Incorporated and all the companies whose products are represented on our website, harmless against all damages.

### LIFE SUPPORT

Diodes Incorporated products are not authorized for use as critical components in life support devices or systems without the expressed written approval of the President of Diodes Incorporated.



**Стандарт  
Электрон  
Связь**

Мы молодая и активно развивающаяся компания в области поставок электронных компонентов. Мы поставляем электронные компоненты отечественного и импортного производства напрямую от производителей и с крупнейших складов мира.

Благодаря сотрудничеству с мировыми поставщиками мы осуществляем комплексные и плановые поставки широчайшего спектра электронных компонентов.

Собственная эффективная логистика и склад в обеспечивает надежную поставку продукции в точно указанные сроки по всей России.

Мы осуществляем техническую поддержку нашим клиентам и предпродажную проверку качества продукции. На все поставляемые продукты мы предоставляем гарантию .

Осуществляем поставки продукции под контролем ВП МО РФ на предприятия военно-промышленного комплекса России , а также работаем в рамках 275 ФЗ с открытием отдельных счетов в уполномоченном банке. Система менеджмента качества компании соответствует требованиям ГОСТ ISO 9001.

Минимальные сроки поставки, гибкие цены, неограниченный ассортимент и индивидуальный подход к клиентам являются основой для выстраивания долгосрочного и эффективного сотрудничества с предприятиями радиоэлектронной промышленности, предприятиями ВПК и научно-исследовательскими институтами России.

С нами вы становитесь еще успешнее!

**Наши контакты:**

**Телефон:** +7 812 627 14 35

**Электронная почта:** [sales@st-electron.ru](mailto:sales@st-electron.ru)

**Адрес:** 198099, Санкт-Петербург,  
Промышленная ул, дом № 19, литера Н,  
помещение 100-Н Офис 331