

# RECTIFIERS

## High Efficiency, 30A Center-Tap

UES2601  
UES2602  
UES2603  
UES2601HR2  
UES2602HR2  
UES2603HR2

### FEATURES

- Very Low Forward Voltage
- Very Fast Switching Speed
- Convenient Package
- High Surge
- Low Thermal Resistance
- Mechanically Rugged
- Both Polarities Available

### DESCRIPTION

This series combines two high efficiency devices into one package, simplifying installation, reducing heat sink requirements and the need to purchase matched components.

### ABSOLUTE MAXIMUM RATINGS

Peak Inverse Voltage, UES2601, UES2601HR2	50V
Peak Inverse Voltage, UES2602, UES2602HR2	100V
Peak Inverse Voltage, UES2603, UES2603HR2	150V
Maximum Average D.C. Output Current at $T_C = 100^\circ\text{C}$	30A
Non-Repetitive Sinusoidal Surge Current 8.3 ms	400A
Thermal Resistance, Junction to Case	$1^\circ\text{C/W}$
Operating and Storage Temperature Range	$-55^\circ\text{C}$ to $+175^\circ\text{C}$

### POWER CYCLING

These devices possess the unique ability to pass many thousands of cycles of a stress test designed to evaluate the integrity of the bonding systems used in the construction of power rectifiers.

In this stress test, the case of the device is not heat sunk. Full rated forward current is supplied to force a case temperature increase at least  $75^\circ\text{C}$ , at which time, the current is removed and the case allowed to cool. The cycle is repeated a minimum of 5,000 times to simulate equipment being turned on and off. Extended power cycling tests demonstrate a product capability in excess of 25,000 cycles.

### SWITCHING CHARACTERISTICS

The switching times of these ultra-fast rectifiers increase relatively little, with temperature or at different currents. Even in severe applications, such as catch diodes for switching regulators and output rectifiers for high frequency square wave inverters, these devices switch many times faster than the fastest associated transistors. Thus, the stresses on and powers dissipated in the switching transistors are substantially less than when using other rectifiers.

### MECHANICAL SPECIFICATIONS

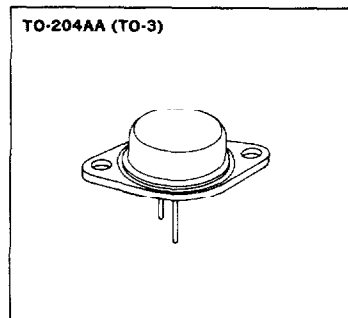
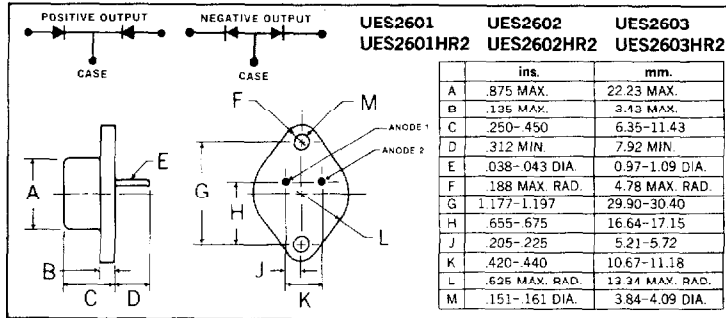

### Note:

Standard polarity is positive output.  
For reverse polarity (negative output) add suffix "R", ie. UES2601R.

**Microsemi Corp.**  
**Watertown**  
*The diode experts*

**ELECTRICAL SPECIFICATIONS**

Type	PIV	Maximum Forward Voltage @		Maximum Reverse Current @		Maximum Reverse Recovery Time*
		T <sub>C</sub> = 25°C	T <sub>C</sub> = 125°C	T <sub>C</sub> = 25°C	T <sub>C</sub> = 125°C	
UES2601/2601HR2	50V	.930V	.825V	20μA	4mA	35nS
UES2602/2602HR2	100V	@ 15A	@ 15A			
UES2603/2603HR2	150V	t <sub>p</sub> = 300μS	t <sub>p</sub> = 300μS			

\* Measured in circuit I<sub>F</sub> = 0.5A, I<sub>R</sub> = 1A, I<sub>REC</sub> = 0.25A

**Output Current vs. Case Temperature**

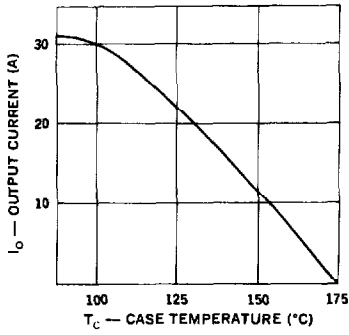

**Peak Output Current vs. Case Temperature**

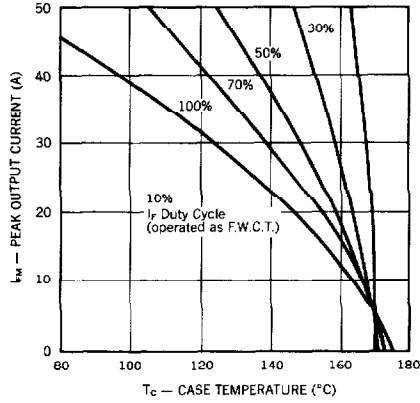

**Forward Current vs. Forward Voltage**

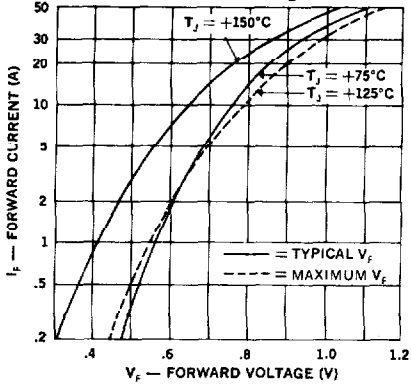

**Typical Reverse Current vs. Reverse Voltage**

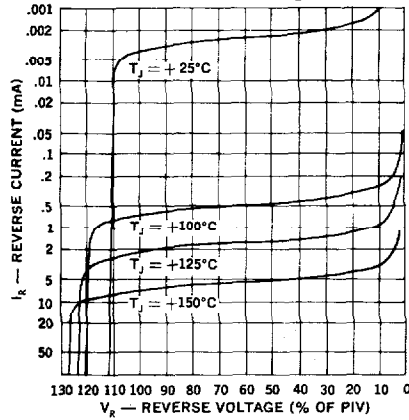

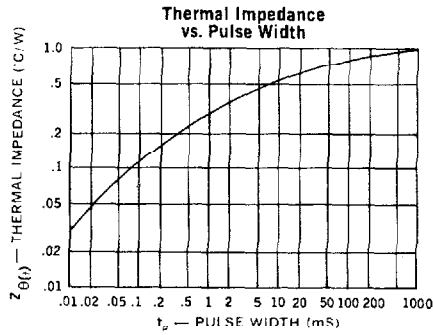
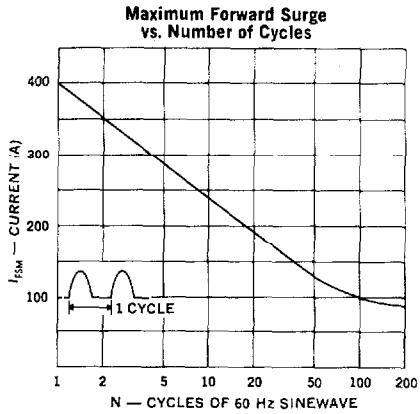

Reverse-Recovery Circuit

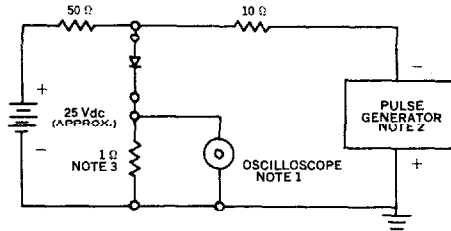

- NOTES:**
- Oscilloscope: Rise time  $\leq 3\text{ns}$ ; input impedance = 50 $\Omega$ .
  - Pulse Generator: Rise time  $\leq 8\text{ns}$ ; source impedance 10 $\Omega$ .
  - Current viewing resistor, non-inductive, coaxial recommended.

**OPTIONAL HIGH RELIABILITY (HR2) SCREENING**

The following tests are performed on 100% of the devices specified UES2601HR2, 2HR2, 3HR2.

SCREEN	MIL-STD-750 METHOD	CONDITIONS
1. High Temperature	1032	24 Hours @ $T_A = 150^\circ\text{C}$
2. Thermal Shock (Temperature Cycling)	1051	F, 20 Cycles, $-55$ to $+150^\circ\text{C}$ . No dwell required @ $25^\circ\text{C}$ , $t \geq 10$ min. at extremes.
3. Hermetic Seal a. Fine b. Gross	1071	H, Helium C, Liquid
4. Thermal Impedance		Sage Test
5. Interim Electrical Parameters	GO/NO GO	$V_F$ and $I_R$ @ $25^\circ\text{C}$
6. High Temperature Reverse Bias (HTRB)	1038	A, 48 Hours, $T_C = 125^\circ\text{C}$ , $V_R = 80\%$ of rating
7. Final Electrical Parameters	GO/NO GO	$V_F$ and $I_R$ @ $25^\circ\text{C}$



## Стандарт Электрон Связь

Мы молодая и активно развивающаяся компания в области поставок электронных компонентов. Мы поставляем электронные компоненты отечественного и импортного производства напрямую от производителей и с крупнейших складов мира.

Благодаря сотрудничеству с мировыми поставщиками мы осуществляем комплексные и плановые поставки широчайшего спектра электронных компонентов.

Собственная эффективная логистика и склад в обеспечивает надежную поставку продукции в точно указанные сроки по всей России.

Мы осуществляем техническую поддержку нашим клиентам и предпродажную проверку качества продукции. На все поставляемые продукты мы предоставляем гарантию .

Осуществляем поставки продукции под контролем ВП МО РФ на предприятия военно-промышленного комплекса России , а также работаем в рамках 275 ФЗ с открытием отдельных счетов в уполномоченном банке. Система менеджмента качества компании соответствует требованиям ГОСТ ISO 9001.

Минимальные сроки поставки, гибкие цены, неограниченный ассортимент и индивидуальный подход к клиентам являются основой для выстраивания долгосрочного и эффективного сотрудничества с предприятиями радиоэлектронной промышленности, предприятиями ВПК и научно-исследовательскими институтами России.

С нами вы становитесь еще успешнее!

### Наши контакты:

**Телефон:** +7 812 627 14 35

**Электронная почта:** [sales@st-electron.ru](mailto:sales@st-electron.ru)

**Адрес:** 198099, Санкт-Петербург,  
Промышленная ул, дом № 19, литера Н,  
помещение 100-Н Офис 331