

## Optocoupler, Phototransistor Output, Dual Channel, SOIC-8 package

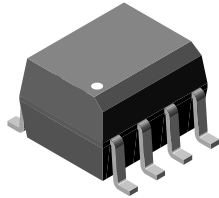

1179018

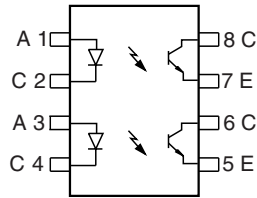

### DESCRIPTION

The ILD205T/206T/207T/211T/213T/217T are optically coupled pairs with a Gallium Arsenide infrared LED and a silicon NPN phototransistor. Signal information, including a DC level, can be transmitted by the device while maintaining a high degree of electrical isolation between input and output. The ILD205T/206T/207T/211T/213T/217T come in a standard SOIC-8 small outline package for surface mounting which makes it ideally suited for high density applications with limited space. In addition to eliminating through-holes requirements, this package conforms to standards for surface mounted devices.

A specified minimum and maximum CTR allows a narrow tolerance in the electrical design of the adjacent circuits. The high  $BV_{CEO}$  of 70 V gives a higher safety margin compared to the industry standard of 30 V.

### FEATURES

- Two channel coupler
- SOIC-8 surface mountable package
- Standard lead spacing of 0.05"
- Available only on tape and reel option (conforms to EIA standard 481-2)
- Isolation test voltage, 4000  $V_{RMS}$
- Compatible with dual wave, vapor phase and IR reflow soldering
- Lead (Pb)-free component
- Component in accordance to RoHS 2002/95/EC and WEEE 2002/96/EC



**RoHS**  
COMPLIANT

### AGENCY APPROVALS

- UL1577, file no. E52744 system code Y
- CUL - file no. E52744, equivalent to CSA bulletin 5A
- DIN EN 60747-5-2 (VDE 0884) available with option 1

### ORDER INFORMATION

PART	REMARKS
ILD205T	CTR 40 to 80 %, SOIC-8
ILD206T	CTR 63 to 125 %, SOIC-8
ILD207T	CTR 100 to 200 %, SOIC-8
ILD211T	CTR > 20 %, SOIC-8
ILD213T	CTR > 100 %, SOIC-8
ILD217T	CTR > 100 %, SOIC-8

# ILD205T/206T/207T/211T/213T/217T



Vishay Semiconductors Optocoupler, Phototransistor Output,  
Dual Channel, SOIC-8 package

ABSOLUTE MAXIMUM RATINGS <sup>(1)</sup>				
PARAMETER	TEST CONDITION	SYMBOL	VALUE	UNIT
<b>INPUT</b>				
Peak reverse voltage		$V_R$	6	V
Peak pulsed voltage	1 $\mu$ s, 300 pps		1	A
Continuous forward current per channel			30	mA
Power dissipation		$P_{diss}$	50	mW
Derate linearly from 25 °C			0.66	mW/°C
<b>OUTPUT</b>				
Collector emitter breakdown voltage		$BV_{CEO}$	70	V
Emitter collector breakdown voltage		$BV_{ECO}$	7	V
Power dissipation per channel		$P_{diss}$	125	mW
Derate linearly from 25 °C			1.67	mW/°C
<b>COUPLER</b>				
Isolation test voltage	t = 1 s	$V_{ISO}$	4000	$V_{RMS}$
Total package dissipation ambient (2 LEDs and 2 detectors, 2 channels)		$P_{tot}$	300	mW
Derate linearly from 25 °C			4	mW/°C
Storage temperature		$T_{stg}$	- 55 to + 150	°C
Operating temperature		$T_{amb}$	- 55 to + 100	°C
Soldering time from 260 °C <sup>(2)</sup>		$T_{sld}$	10	s

## Notes

<sup>(1)</sup>  $T_{amb} = 25$  °C, unless otherwise specified.

Stresses in excess of the absolute Maximum Ratings can cause permanent damage to the device. Functional operation of the device is not implied at these or any other conditions in excess of those given in the operational sections of this document. Exposure to absolute Maximum Rating for extended periods of the time can adversely affect reliability.

<sup>(2)</sup> Refer to reflow profile for soldering conditions for surface mounted devices.

ELECTRICAL CHARACTERISTICS							
PARAMETER	TEST CONDITION	PART	SYMBOL	MIN.	TYP.	MAX.	UNIT
<b>INPUT</b>							
Forward voltage	$I_F = 10$ mA		$V_F$		1.2	1.55	V
Reverse current	$V_R = 6$ V		$I_R$		0.1	100	$\mu$ A
Capacitance	$V_R = 0$ V		$C_O$		25		pF
<b>OUTPUT</b>							
Collector emitter breakdown voltage	$I_C = 10$ $\mu$ A		$BV_{CEO}$	70			V
Emitter collector breakdown voltage	$I_E = 10$ $\mu$ A		$BV_{ECO}$	7			V
Collector emitter leakage current	$V_{CE} = 10$ V, $I_F = 0$ A		$I_{CEO}$		5	50	nA
Collector emitter capacitance	$V_{CE} = 0$ V		$C_{CE}$		10		pF
<b>COUPLER</b>							
Collector emitter saturation voltage	$I_F = 10$ mA, $I_C = 2.5$ mA		$V_{CEsat}$			0.4	V
Capacitance (input to output)			$C_{IO}$		0.5		pF
Resistance (input to output)			$R_{IO}$		100		G $\Omega$

## Note

$T_{amb} = 25$  °C, unless otherwise specified.

Minimum and maximum values were tested requirements. Typical values are characteristics of the device and are the result of engineering evaluations. Typical values are for information only and are not part of the testing requirements.



# ILD205T/206T/207T/211T/213T/217T

Optocoupler, Phototransistor Output, Vishay Semiconductors  
Dual Channel, SOIC-8 package

CURRENT TRANSFER RATIO							
PARAMETER	TEST CONDITION	PART	SYMBOL	MIN.	TYP.	MAX.	UNIT
DC current transfer ratio	$V_{CE} = 5\text{ V}, I_F = 10\text{ mA}$	ILD205T	$CTR_{DC}$	40		80	%
		ILD206T	$CTR_{DC}$	63		125	%
		ILD207T	$CTR_{DC}$	100		200	%
		ILD211T	$CTR_{DC}$	20			%
		ILD213T	$CTR_{DC}$	100			%
	$V_{CE} = 5\text{ V}, I_F = 1.0\text{ mA}$	ILD205T	$CTR_{DC}$	13	30		%
		ILD206T	$CTR_{DC}$	22	45		%
		ILD207T	$CTR_{DC}$	34	70		%
ILD217T	$CTR_{DC}$	100	120		%		

SWITCHING CHARACTERISTICS							
PARAMETER	TEST CONDITION	PART	SYMBOL	MIN.	TYP.	MAX.	UNIT
Turn-on time	$I_C = 2\text{ mA}, R_L = 100\ \Omega,$ $V_{CC} = 5\text{ V}$		$t_{on}$	5			$\mu\text{s}$
Turn-off time	$I_C = 2\text{ mA}, R_L = 100\ \Omega,$ $V_{CC} = 5\text{ V}$		$t_{off}$	4			$\mu\text{s}$

SAFETY AND INSULATION RATINGS							
PARAMETER	TEST CONDITION	SYMBOL	MIN.	TYP.	MAX.	UNIT	
Climatic classification (according to IEC 68 part 1)				55/100/21			
Comparative tracking index		CTI	175		399		
$V_{IOTM}$			6000			V	
$V_{IORM}$			560			V	
$P_{SO}$					350	mW	
$I_{SI}$					150	mA	
$T_{SI}$					165	°C	
Creepage			4			mm	
Clearance			4			mm	
Insulation thickness, reinforced rated	per IEC60950 2.10.5.1		0.2			mm	

#### Note

As per IEC60747-5-2, §7.4.3.8.1, this optocoupler is suitable for “safe electrical insulation” only within the safety ratings. Compliance with the safety ratings shall be ensured by means of protective circuits.

## TYPICAL CHARACTERISTICS

$T_{amb} = 25\text{ }^{\circ}\text{C}$ , unless otherwise specified

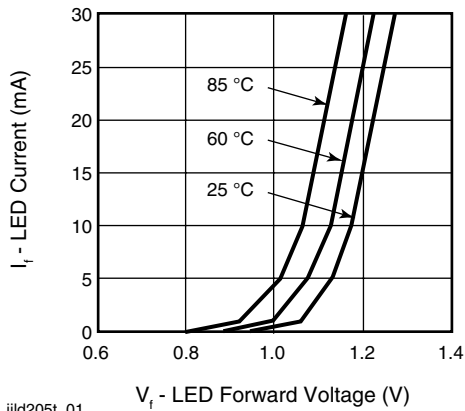

iiild205t\_01

Fig. 1 - Forward Current vs. Forward Voltage

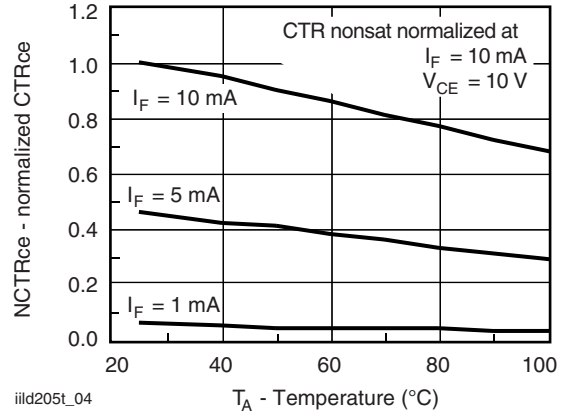

iiild205t\_04

Fig. 4 - Current Transfer Ratio (normalized) vs. Ambient Temperature

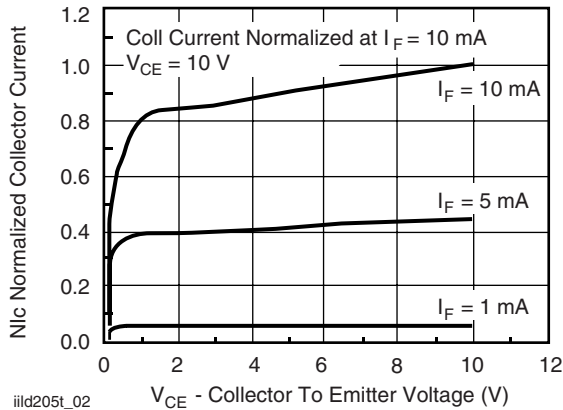

iiild205t\_02

Fig. 2 - Collector Emitter Current vs.  $V_{CE}$

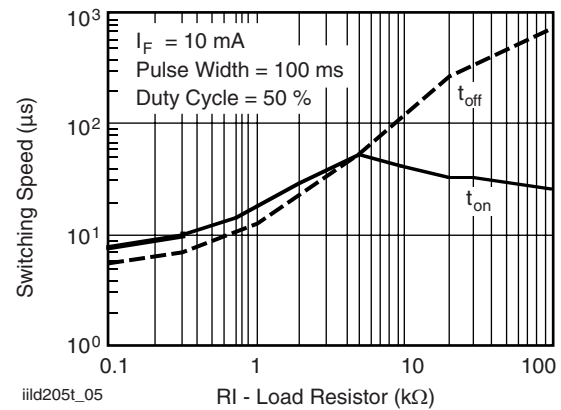

iiild205t\_05

Fig. 5 - Switching Speed vs. Load Resistor

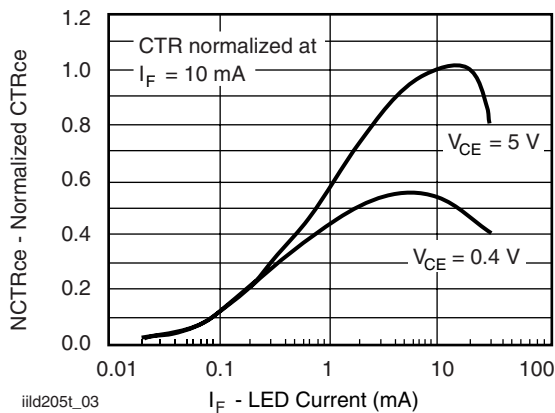

iiild205t\_03

Fig. 3 - Normalized  $CTR_{CE}$  vs. Forward Current

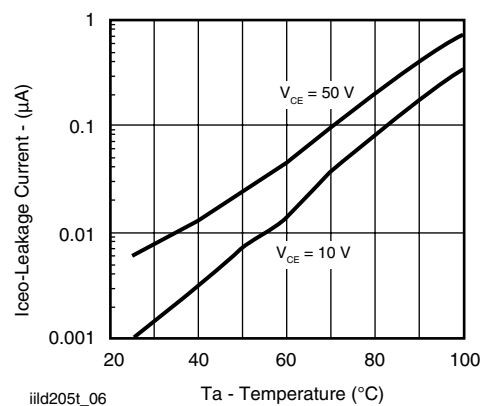

iiild205t\_06

Fig. 6 - Collector Current vs. Ambient Temperature

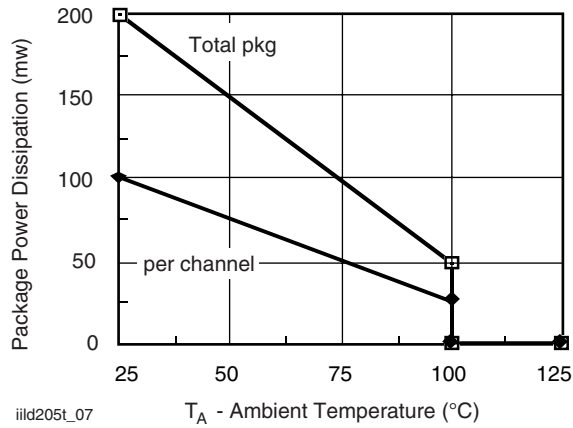
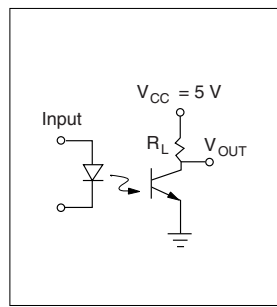

Fig. 7 - Power Dissipation vs. Ambient Temperature



iiid205t\_08

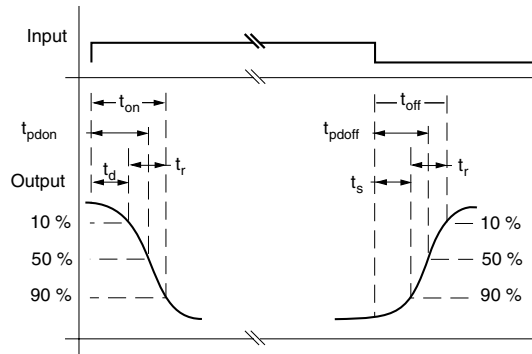

Fig. 8 Switching Test Circuit

# ILD205T/206T/207T/211T/213T/217T



Vishay Semiconductors Optocoupler, Phototransistor Output,  
Dual Channel, SOIC-8 package

## PACKAGE DIMENSIONS in inches (millimeters)

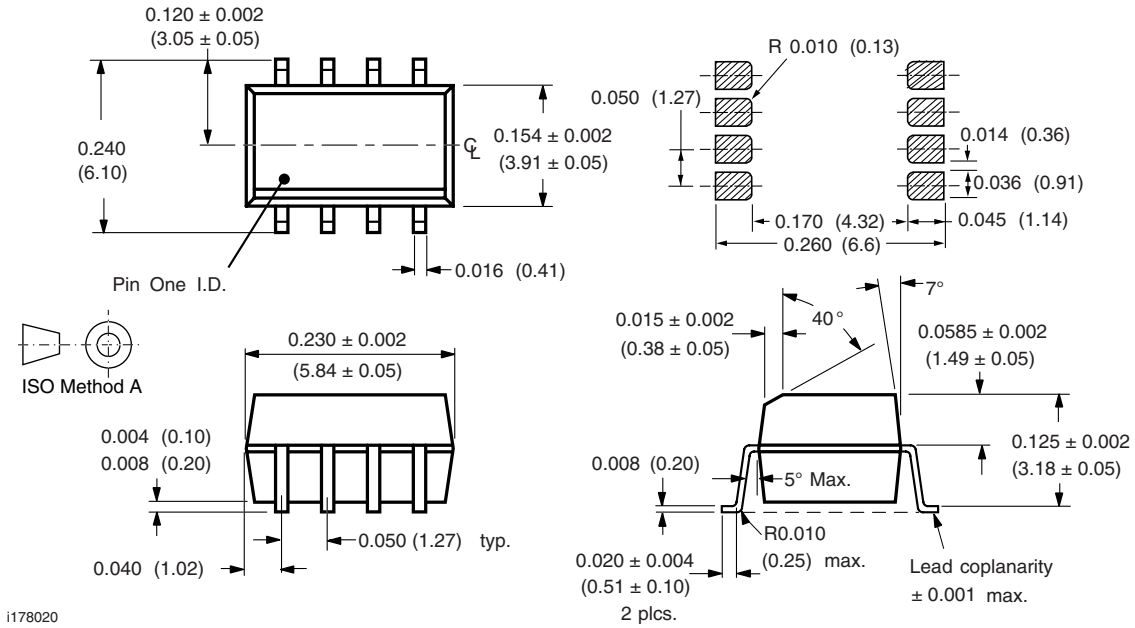



## **OZONE DEPLETING SUBSTANCES POLICY STATEMENT**

It is the policy of Vishay Semiconductor GmbH to

1. Meet all present and future national and international statutory requirements.
2. Regularly and continuously improve the performance of our products, processes, distribution and operating systems with respect to their impact on the health and safety of our employees and the public, as well as their impact on the environment.

It is particular concern to control or eliminate releases of those substances into the atmosphere which are known as ozone depleting substances (ODSs).

The Montreal Protocol (1987) and its London Amendments (1990) intend to severely restrict the use of ODSs and forbid their use within the next ten years. Various national and international initiatives are pressing for an earlier ban on these substances.

Vishay Semiconductor GmbH has been able to use its policy of continuous improvements to eliminate the use of ODSs listed in the following documents.

1. Annex A, B and list of transitional substances of the Montreal Protocol and the London Amendments respectively.
2. Class I and II ozone depleting substances in the Clean Air Act Amendments of 1990 by the Environmental Protection Agency (EPA) in the USA
3. Council Decision 88/540/EEC and 91/690/EEC Annex A, B and C (transitional substances) respectively.

Vishay Semiconductor GmbH can certify that our semiconductors are not manufactured with ozone depleting substances and do not contain such substances.

We reserve the right to make changes to improve technical design  
and may do so without further notice.

Parameters can vary in different applications. All operating parameters must be validated for each customer application by the customer. Should the buyer use Vishay Semiconductors products for any unintended or unauthorized application, the buyer shall indemnify Vishay Semiconductors against all claims, costs, damages, and expenses, arising out of, directly or indirectly, any claim of personal damage, injury or death associated with such unintended or unauthorized use.

Vishay Semiconductor GmbH, P.O.B. 3535, D-74025 Heilbronn, Germany



## Disclaimer

All product specifications and data are subject to change without notice.

Vishay Intertechnology, Inc., its affiliates, agents, and employees, and all persons acting on its or their behalf (collectively, "Vishay"), disclaim any and all liability for any errors, inaccuracies or incompleteness contained herein or in any other disclosure relating to any product.

Vishay disclaims any and all liability arising out of the use or application of any product described herein or of any information provided herein to the maximum extent permitted by law. The product specifications do not expand or otherwise modify Vishay's terms and conditions of purchase, including but not limited to the warranty expressed therein, which apply to these products.

No license, express or implied, by estoppel or otherwise, to any intellectual property rights is granted by this document or by any conduct of Vishay.

The products shown herein are not designed for use in medical, life-saving, or life-sustaining applications unless otherwise expressly indicated. Customers using or selling Vishay products not expressly indicated for use in such applications do so entirely at their own risk and agree to fully indemnify Vishay for any damages arising or resulting from such use or sale. Please contact authorized Vishay personnel to obtain written terms and conditions regarding products designed for such applications.

Product names and markings noted herein may be trademarks of their respective owners.





## Стандарт Электрон Связь

Мы молодая и активно развивающаяся компания в области поставок электронных компонентов. Мы поставляем электронные компоненты отечественного и импортного производства напрямую от производителей и с крупнейших складов мира.

Благодаря сотрудничеству с мировыми поставщиками мы осуществляем комплексные и плановые поставки широчайшего спектра электронных компонентов.

Собственная эффективная логистика и склад в обеспечивает надежную поставку продукции в точно указанные сроки по всей России.

Мы осуществляем техническую поддержку нашим клиентам и предпродажную проверку качества продукции. На все поставляемые продукты мы предоставляем гарантию .

Осуществляем поставки продукции под контролем ВП МО РФ на предприятия военно-промышленного комплекса России , а также работаем в рамках 275 ФЗ с открытием отдельных счетов в уполномоченном банке. Система менеджмента качества компании соответствует требованиям ГОСТ ISO 9001.

Минимальные сроки поставки, гибкие цены, неограниченный ассортимент и индивидуальный подход к клиентам являются основой для выстраивания долгосрочного и эффективного сотрудничества с предприятиями радиоэлектронной промышленности, предприятиями ВПК и научно-исследовательскими институтами России.

С нами вы становитесь еще успешнее!

### Наши контакты:

**Телефон:** +7 812 627 14 35

**Электронная почта:** [sales@st-electron.ru](mailto:sales@st-electron.ru)

**Адрес:** 198099, Санкт-Петербург,  
Промышленная ул, дом № 19, литера Н,  
помещение 100-Н Офис 331