

1.5/1.9GHz LNA GaAs MMIC

■GENERAL DESCRIPTION

NJG1107KB2 is a Low Noise Amplifier GaAs MMIC designed for 1.5GHz and 1.9GHz band digital cellular phone and Japanese PHS handsets. This amplifier provides low noise figure, high gain and high IP3 operated by single low positive power supply.

This amplifier includes internal self-bias circuit and input DC blocking capacitor.

An ultra small and thin package of FLP6 is adopted.

■PACKAGE OUTLINE



NJG1107KB2

■FEATURES

- Low voltage operation +2.7V typ.
- Low current consumption 3.0mA typ.
- High small signal gain 17dB typ. @f=1.49GHz
15dB typ. @f=1.96GHz
- Low noise figure 1.2dB typ. @f=1.49GHz
1.2dB typ. @f=1.96GHz
- High Input IP3 -4.0dBm typ. @f=1.4900+1.4901GHz
-2.0dBm typ. @f=1.9600+1.9601GHz
- Ultra small & ultra thin package FLP6-B2 (Mount Size: 2.1x2.0x0.75mm)
- This amplifier can be tuned into various frequency range.(Best for 1.5GHz or 1.9GHz Band)

■PIN CONFIGURATION

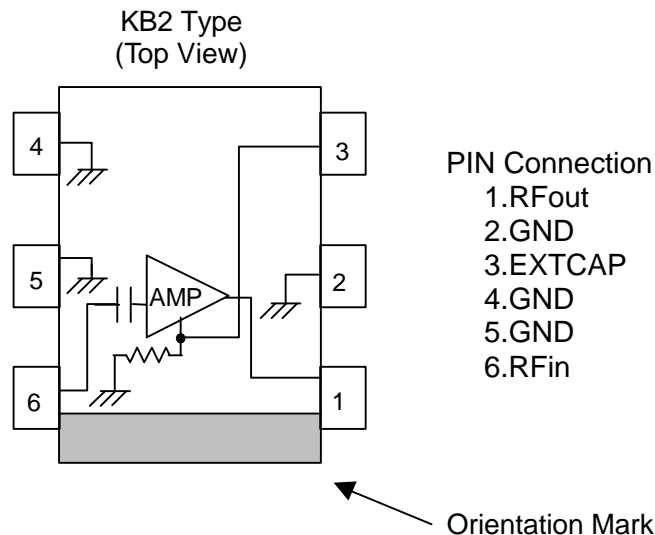

Note: Specifications and description listed in this catalog are subject to change without prior notice.

NJG1107KB2

■ABSOLUTE MAXIMUM RATINGS

($T_a=+25^{\circ}\text{C}$, $Z_s=Z_l=50\Omega$)

PARAMETER	SYMBOL	CONDITIONS	RATINGS	UNIT
Drain Voltage	V_{DD}		6.0	V
Input Power	Pin	$V_{DD}=2.7\text{V}$	+15	dBm
Power Dissipation	P_D		450	mW
Operating Temp.	T_{opr}		-40~+85	$^{\circ}\text{C}$
Storage Temp.	T_{stg}		-55~+125	$^{\circ}\text{C}$

■ELECTRICAL CHARACTERISTICS 1 (1.5GHz Band)

($V_{DD}=2.7\text{V}$, $f=1.49\text{GHz}$, $T_a=+25^{\circ}\text{C}$, $Z_s=Z_l=50\Omega$, TEST CIRCUIT1)

PARAMETER	SYMBOL	CONDITIONS	MIN	TYP	MAX	UNIT
Operating Frequency	freq1		1.47	1.49	1.51	GHz
Drain Voltage	V_{DD}		2.5	2.7	5.5	V
Operating Current	I_{DD}	RF OFF	-	3.0	3.8	mA
Small Signal Gain	Gain		15.0	17.0	19.0	dB
Gain Flatness	G_{flat}	$f=1.47\sim 1.51\text{GHz}$	-	0.5	1.0	dB
Noise Figure	NF		-	1.2	1.4	dB
Pout at 1dB Gain Compression point	P_{-1dB}		-6.0	-2.0	-	dBm
Input 3rd Order Intercept Point	IIP3	$f=1.49+1.4901\text{GHz}$ RFIn=-35dBm	-6.0	-4.0	-	dBm
RF Input Port VSWR	$VSWR_i$		-	1.6	2.2	
RF Output Port VSWR	$VSWR_o$		-	1.6	2.2	

■ELECTRICAL CHARACTERISTICS 2 (1.9GHz Band)

($V_{DD}=2.7\text{V}$, $f=1.96\text{GHz}$, $T_a=+25^{\circ}\text{C}$, $Z_s=Z_l=50\Omega$, TEST CIRCUIT1)

PARAMETER	SYMBOL	CONDITIONS	MIN	TYP	MAX	UNIT
Operating Frequency	freq2		1.89	1.96	1.99	GHz
Drain Voltage	V_{DD}		2.5	2.7	5.5	V
Operating Current	I_{DD}	RF OFF	-	3.0	3.8	mA
Small Signal Gain	Gain		13.0	15.0	17.0	dB
Gain Flatness	G_{flat}	$f=1.89\sim 1.99\text{GHz}$	-	0.5	1.0	dB
Noise Figure	NF		-	1.2	1.4	dB
Pout at 1dB Gain Compression point	P_{-1dB}		-3.0	+1.0	-	dBm
Input 3rd order Intercept Point	IIP3	$f=1.96+1.9601\text{GHz}$ RFIn=-30dBm	-6.0	-2.0	-	dBm
RF Input Port VSWR	$VSWR_i$		-	1.6	2.2	
RF Output Port VSWR	$VSWR_o$		-	1.6	2.2	

■ELECTRICAL CHARACTERISTICS 3 (1.8GHz Band)

($V_{DD}=2.7V$, $f=1.76GHz$, $T_a=+25^{\circ}C$, $Z_s=Z_l=50\Omega$, TEST CIRCUIT1)

PARAMETER	SYMBOL	CONDITIONS	MIN	TYP	MAX	UNIT
Operating Frequency	freq3		1.75	1.76	1.78	GHz
Drain Voltage	V_{DD}		2.5	2.7	5.5	V
Operating Current	I_{DD}	RF OFF	-	3.0	3.8	mA
Small Signal Gain	Gain		-	16.0	-	dB
Gain Flatness	G_{flat}	$f=1.75\sim 1.78GHz$	-	0.5	-	dB
Noise Figure	NF		-	1.2	-	dB
Pout at 1dB Compression point	P_{-1dB}		-	1.1	-	dBm
Input 3rd order Intercept Point	IIP3	$f=1.76+1.7601GHz$ RFIn=-35dBm	-	-2.0	-	dBm
RF Input Port VSWR	$VSWR_i$		-	1.6	-	-
RF Output Port VSWR	$VSWR_o$		-	1.6	-	-

■ELECTRICAL CHARACTERISTICS 4 (1.5GHz Band ,Low Gain Version)

($V_{DD}=2.7V$, $f=1.49GHz$, $T_a=+25^{\circ}C$, $Z_s=Z_l=50\Omega$, TEST CIRCUIT2)

PARAMETER	SYMBOL	CONDITIONS	MIN	TYP	MAX	UNIT
Operating Frequency	freq4		1.47	1.49	1.51	GHz
Drain Voltage	V_{DD}		2.5	2.7	5.5	V
Operating Current	I_{DD}	RF OFF	-	3.0	3.8	mA
Small Signal Gain	Gain		-	14.0	-	dB
Gain Flatness	G_{flat}	$f=1.47\sim 1.51GHz$	-	0.5	-	dB
Noise Figure	NF		-	1.2	-	dB
Pout at 1dB Compression point	P_{-1dB}		-	0.0	-	dBm
Input 3rd order Intercept Point	IIP3	$f=1.49+1.4901GHz$ RFIn=-35dBm	-	-3.0	-	dBm
RF Input Port VSWR	$VSWR_i$		-	1.6	-	
RF Output Port VSWR	$VSWR_o$		-	1.6	-	

NJG1107KB2

■PIN CONFIGURATION

Pin	Function	Description
1	RFout	RF output and voltage supply pin. External matching circuits and a bypass capacitor is required. L3 is a RF choke inductor and C1 is a DC blocking capacitor. These elements are used as output matching circuit. C2 is a bypass capacitor. (Please refer to "TEST CIRCUIT")
2,4,5	GND	Ground pin. To keep good RF grounding performance, please use multiple via holes to connect with ground plane and this pin.
3	EXTCAP	An external bypass capacitor is required. (Please refer to "TEST CIRCUIT")
6	RFin	RF input pin. A DC blocking capacitor is not required. An external matching circuit is required. (Please refer to "TEST CIRCUIT")

TYPICAL CHARACTERISTICS (1.5GHz Band)

NF, Gain vs. frequency

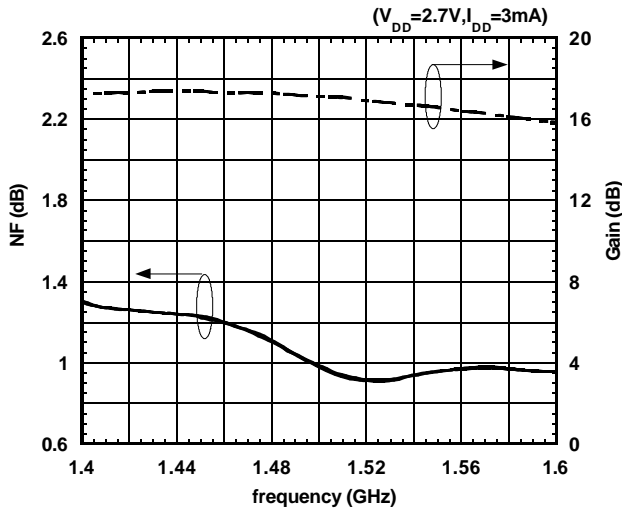

S21, S11, S22, S12 vs. frequency

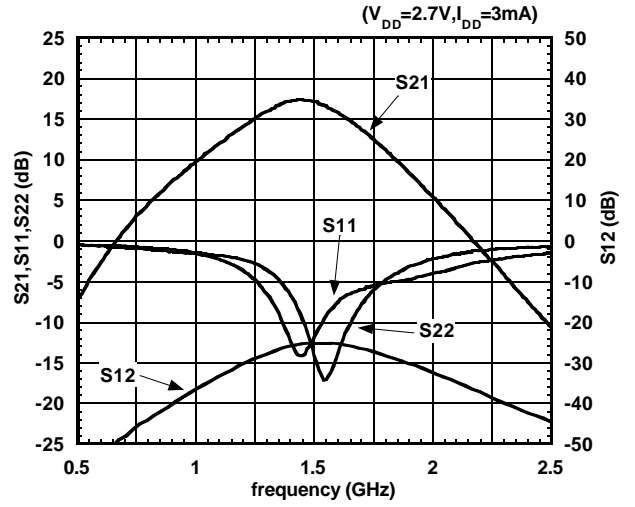

Pout vs. Pin

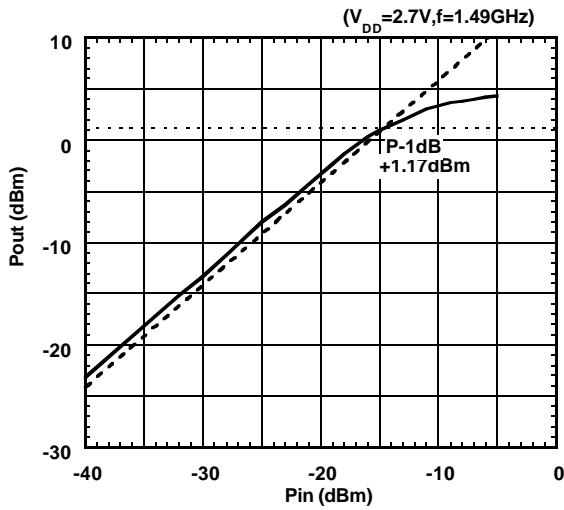

Pout, IM3 vs. Pin

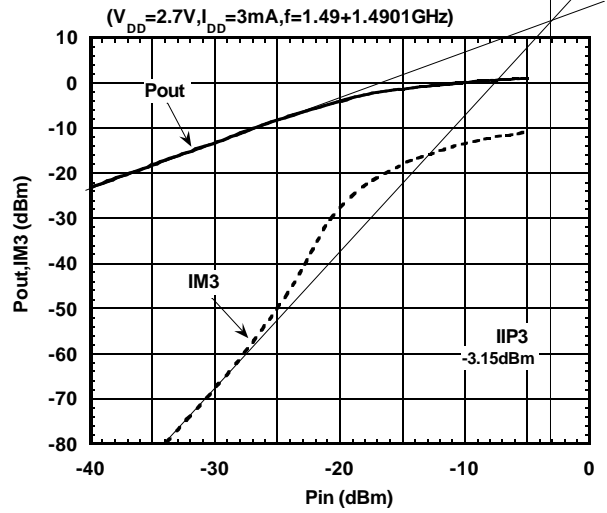

Gain vs. VDD

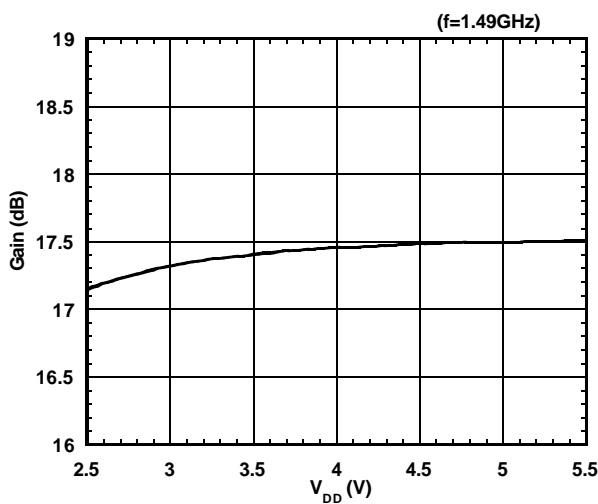

NF, IDD vs. VDD

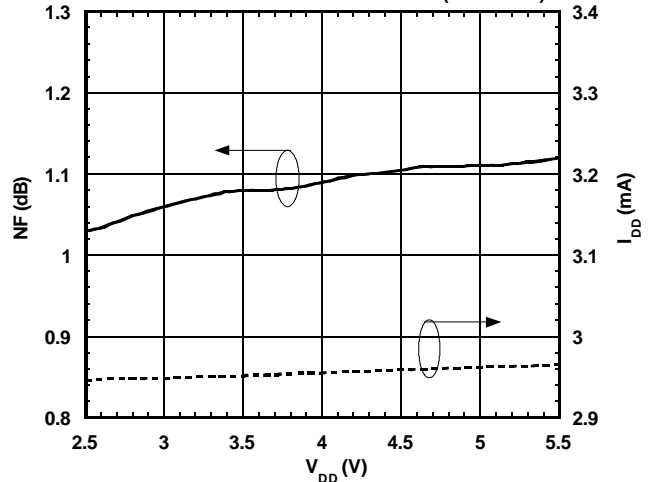

NJG1107KB2

TYPICAL CHARACTERISTICS (1.5GHz Band)

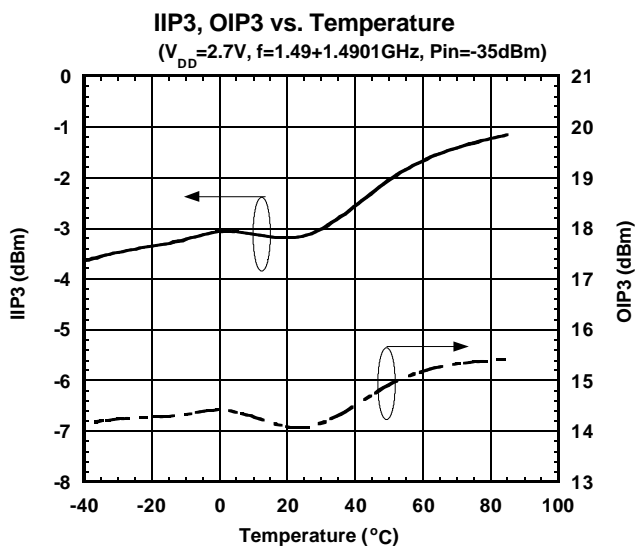
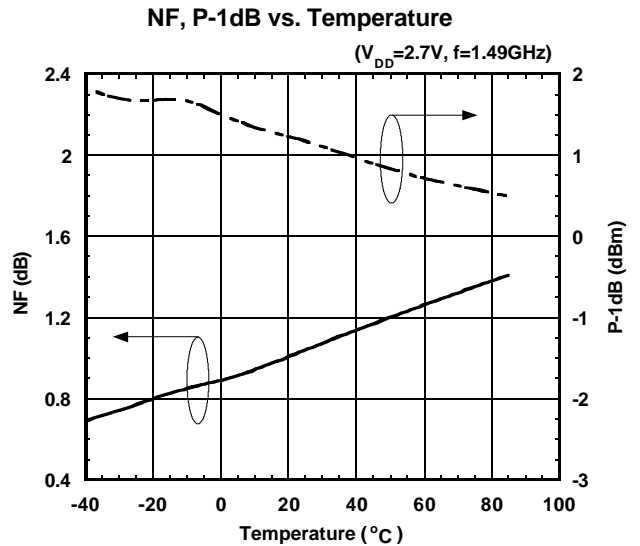
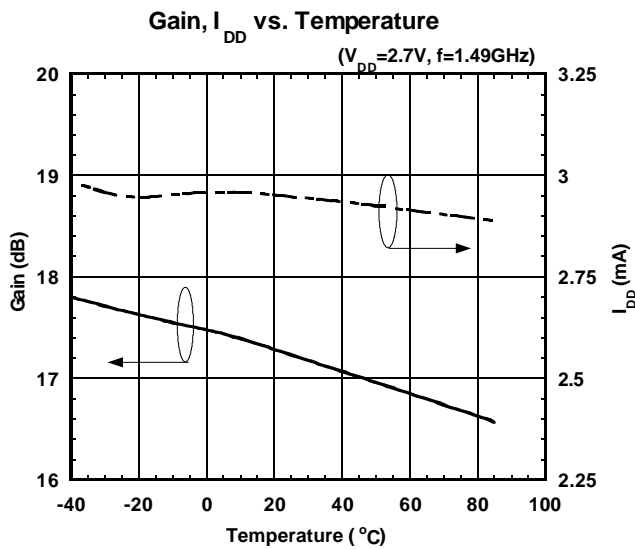
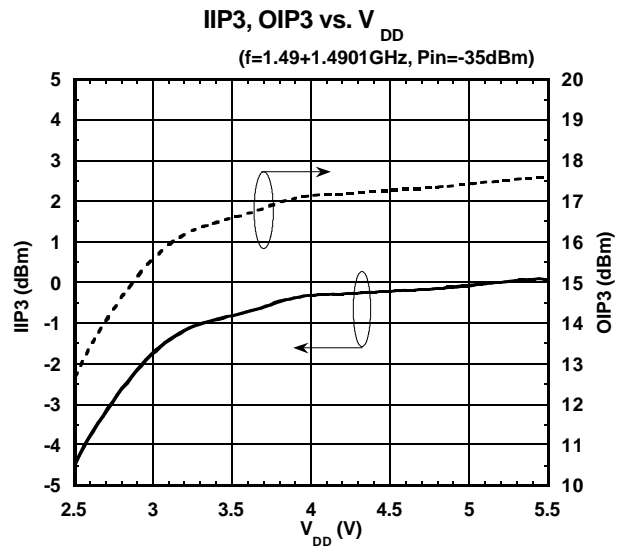
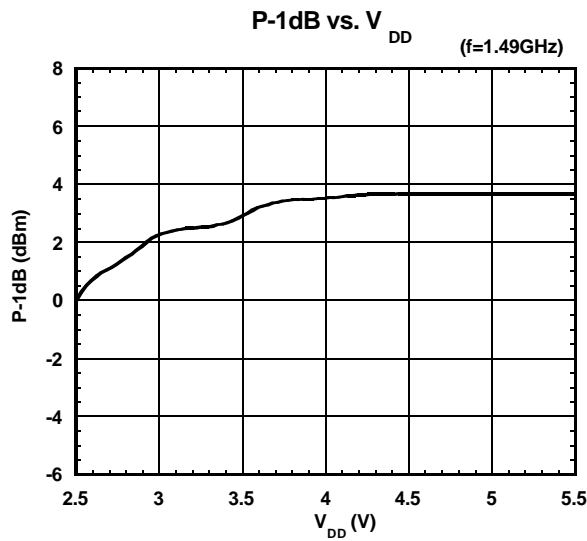

Equations of OIP3 and IIP3

$$OIP3 = \frac{3 \times P_{out} - IM3}{2}$$

$$IIP3 = OIP3 - Gain \quad @ \text{ Pin} = -35\text{dBm}$$

■ TYPICAL CHARACTERISTICS (1.5GHz Band)

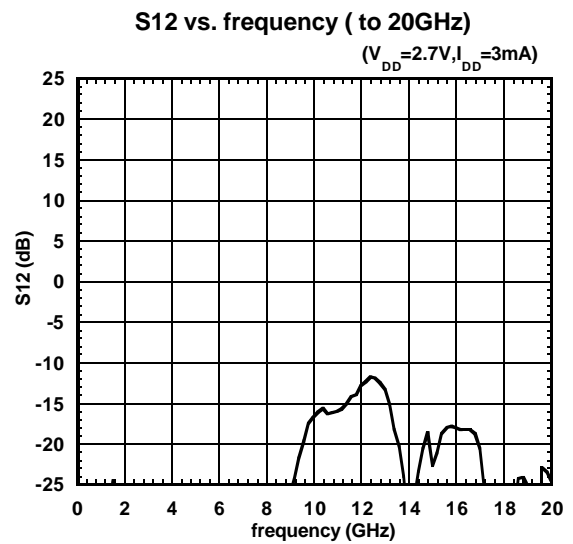
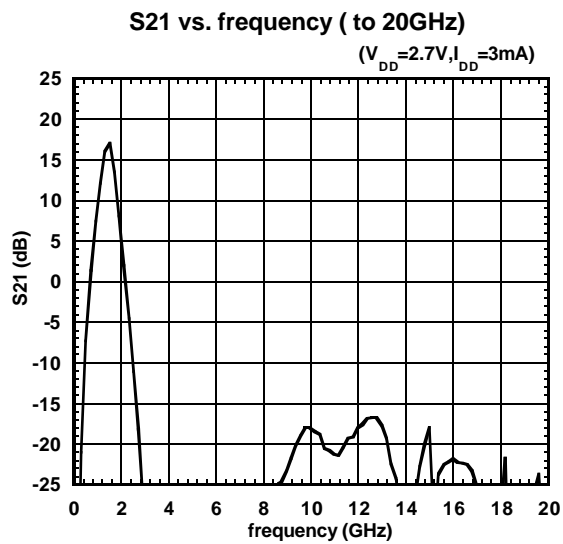
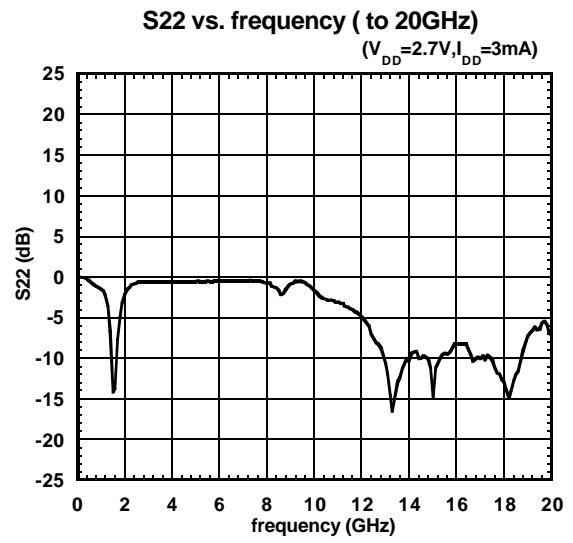
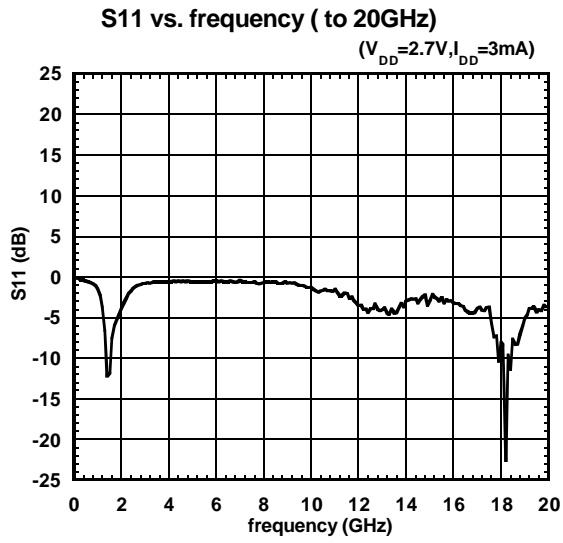

NJG1107KB2

TYPICAL CHARACTERISTICS (1.9GHz Band)

NF, Gain vs. frequency

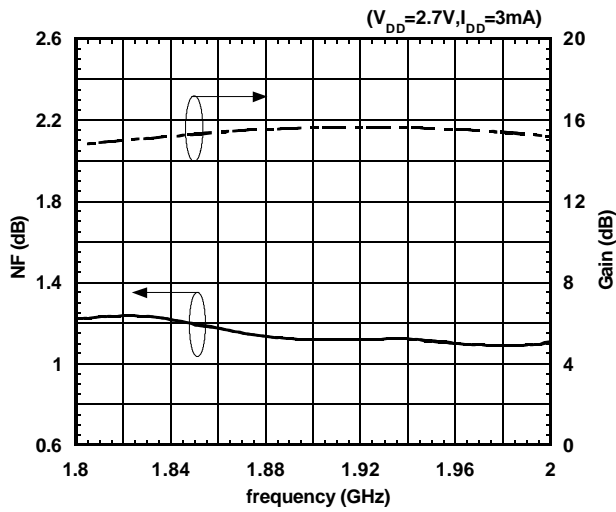

S21, S11, S22, S12 vs. frequency

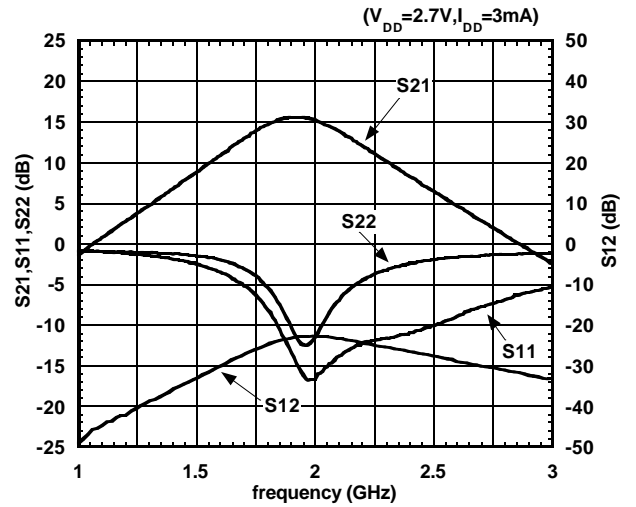

Pout vs. Pin

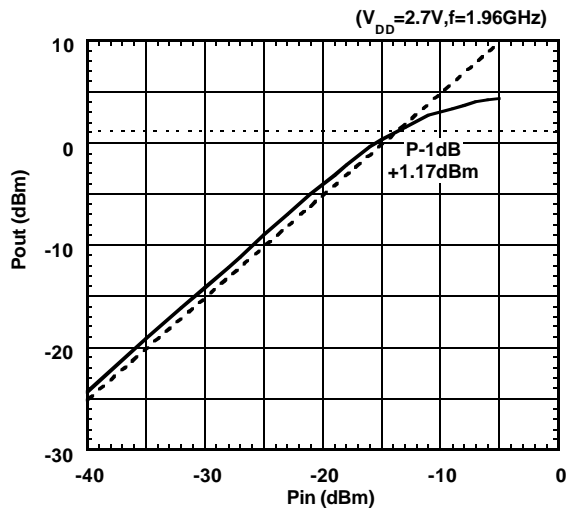

Pout, IM3 vs. Pin

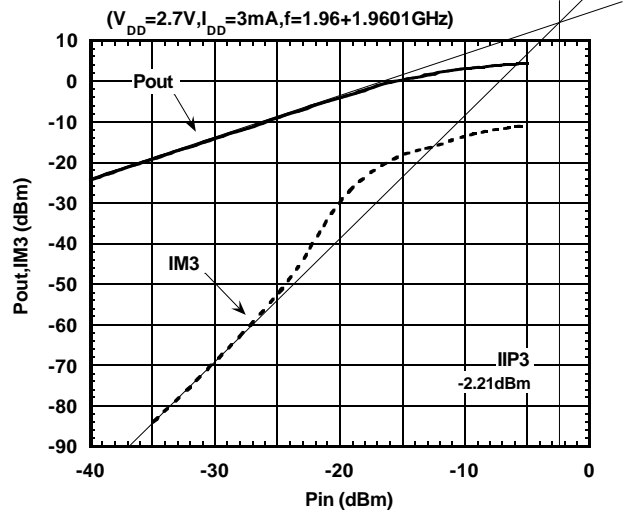

Gain vs. V_{DD}

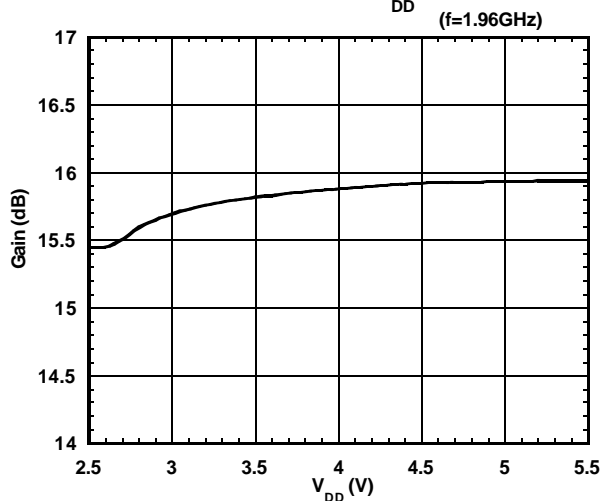

NF, I_{DD} vs. V_{DD}

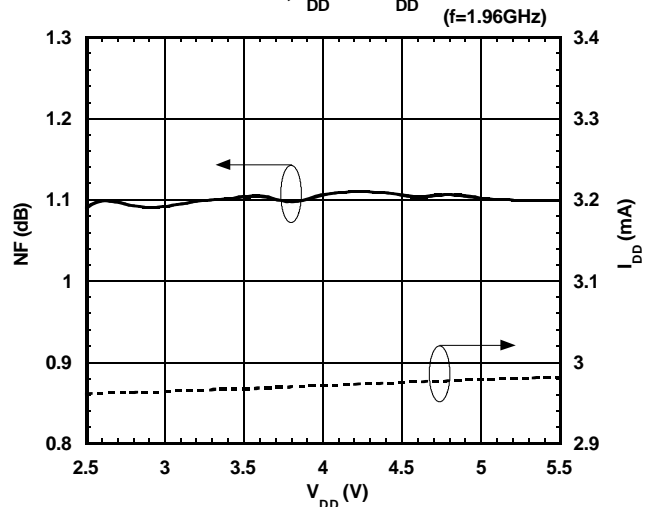

TYPICAL CHARACTERISTICS (1.9GHz Band)

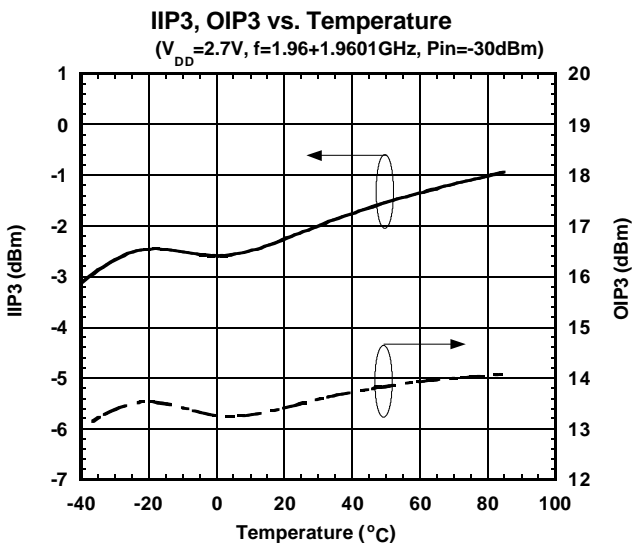
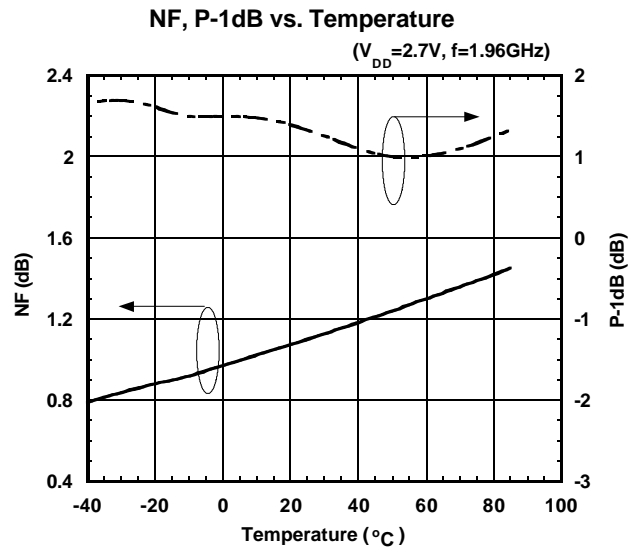
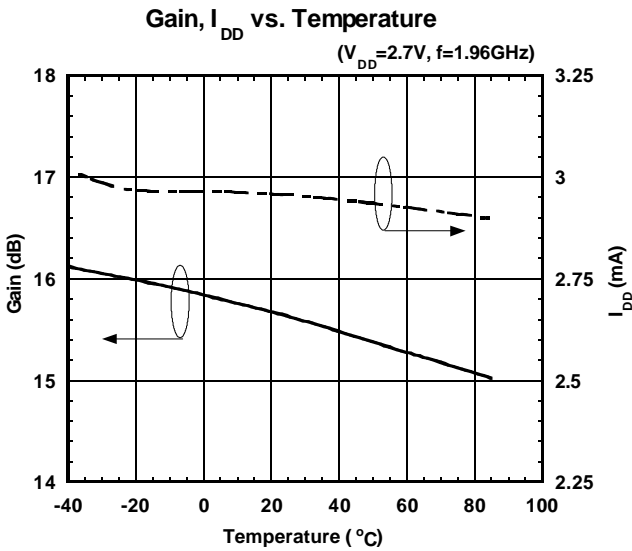
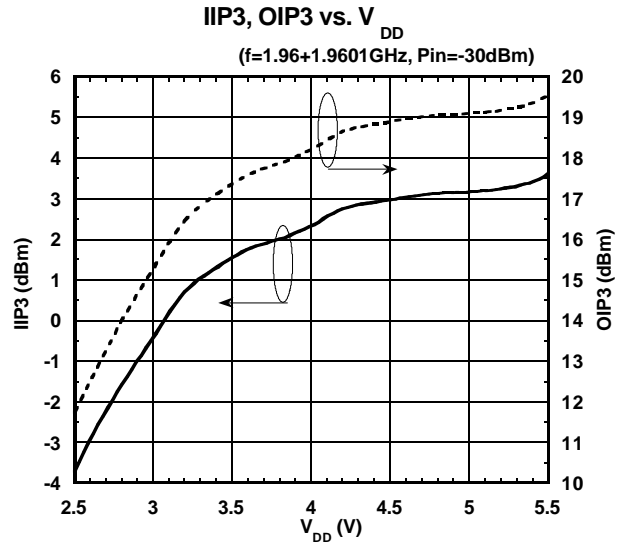
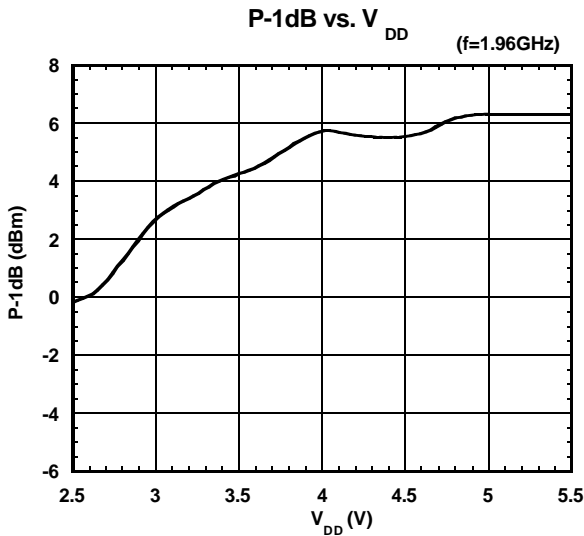

Equations of OIP3 and IIP3

$$OIP3 = \frac{3 \times P_{out} - IM3}{2}$$

$$IIP3 = OIP3 - Gain \quad @ \text{ Pin} = -30\text{dBm}$$

NJG1107KB2

■ TYPICAL CHARACTERISTICS (1.9GHz Band)

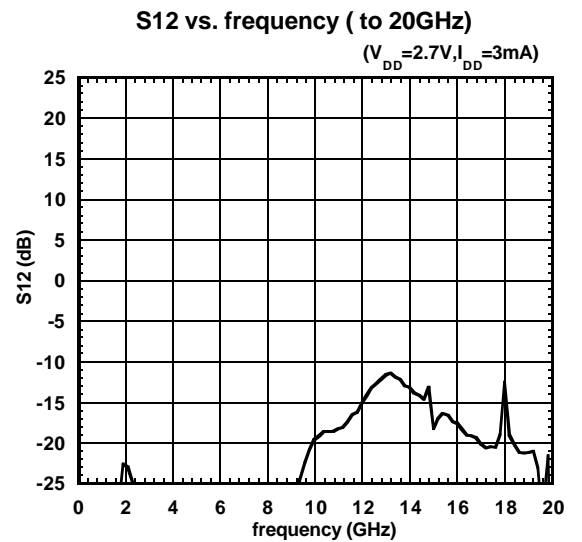
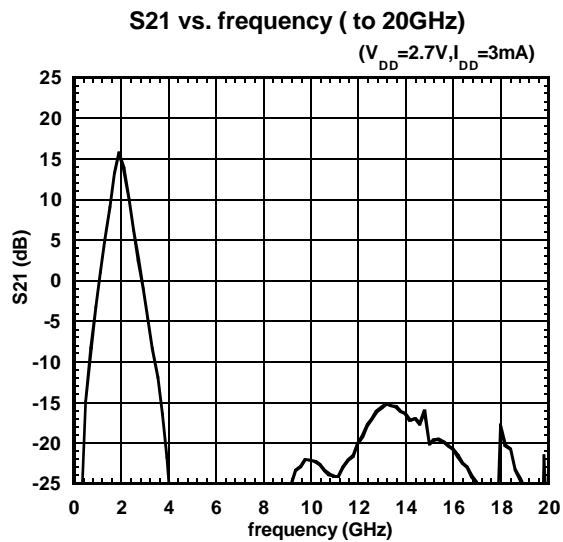
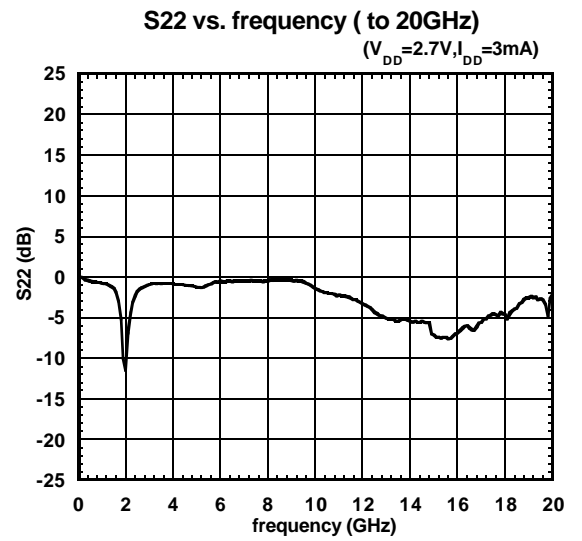
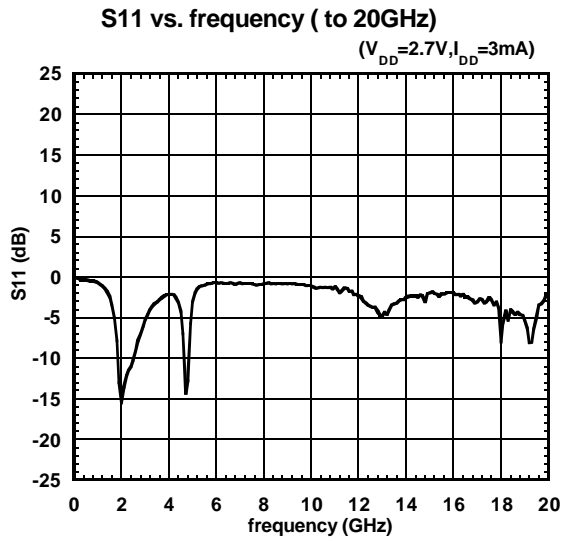

■ TYPICAL CHARACTERISTICS (1.8GHz Band)

NF, Gain vs. frequency

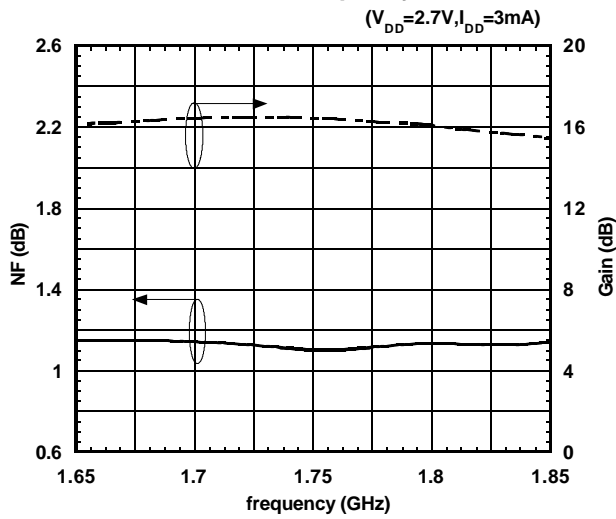

S21, S11, S22, S12 vs. frequency

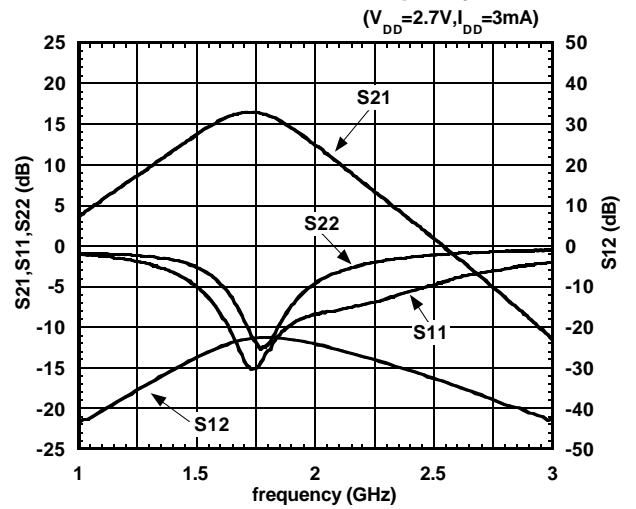

Pout vs. Pin

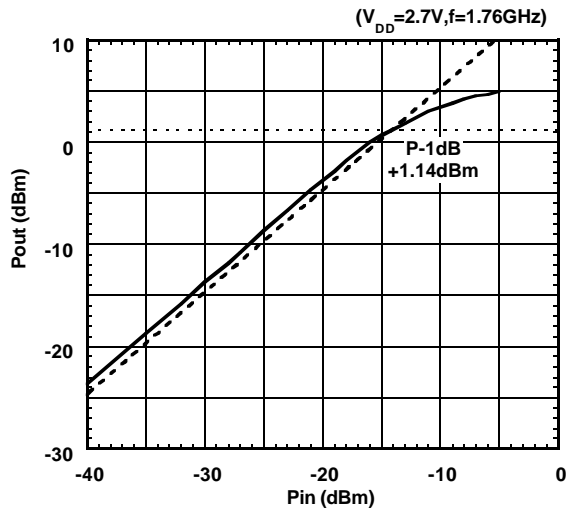

Pout, IM3 vs. Pin

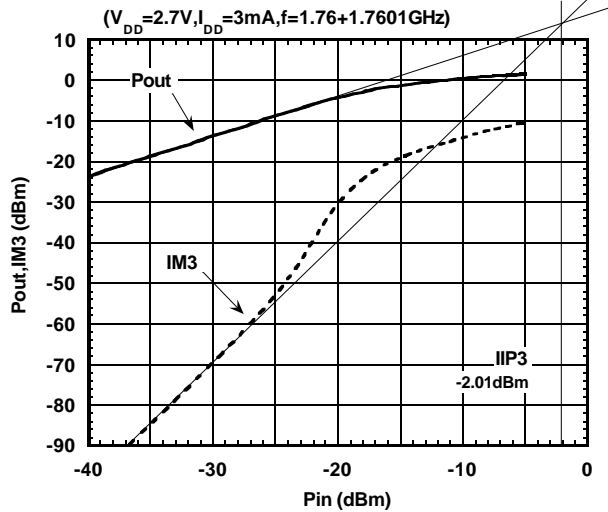

NJG1107KB2

■ TYPICAL CHARACTERISTICS (1.8GHz Band)

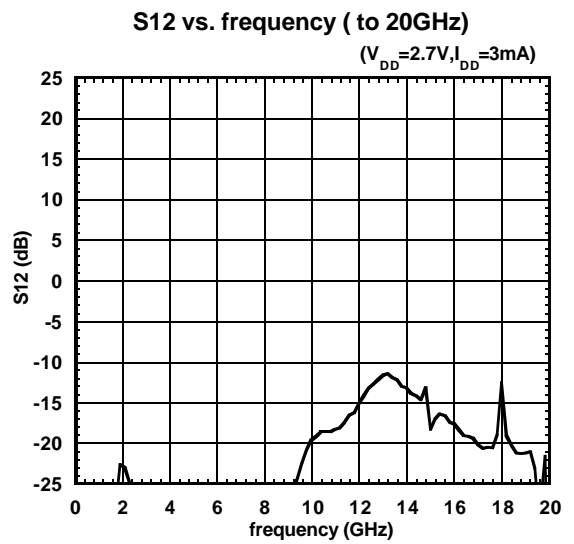
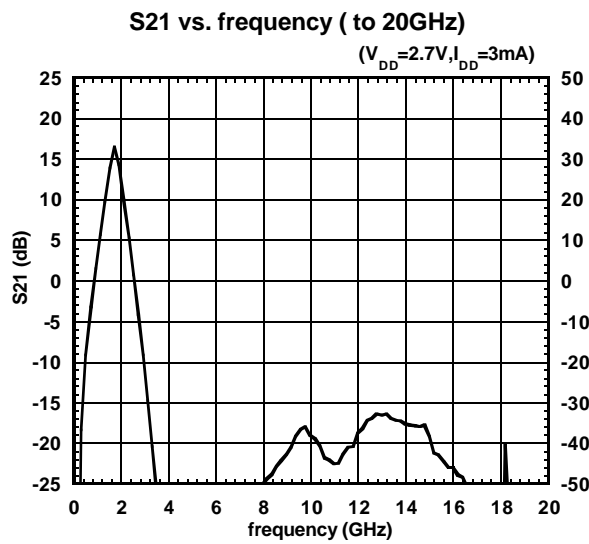
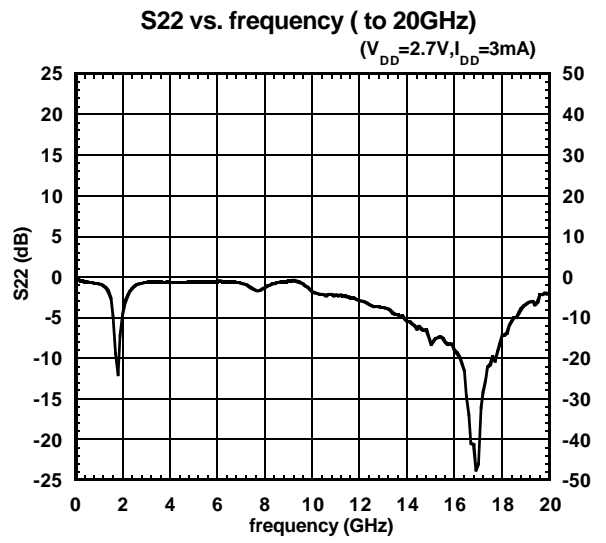
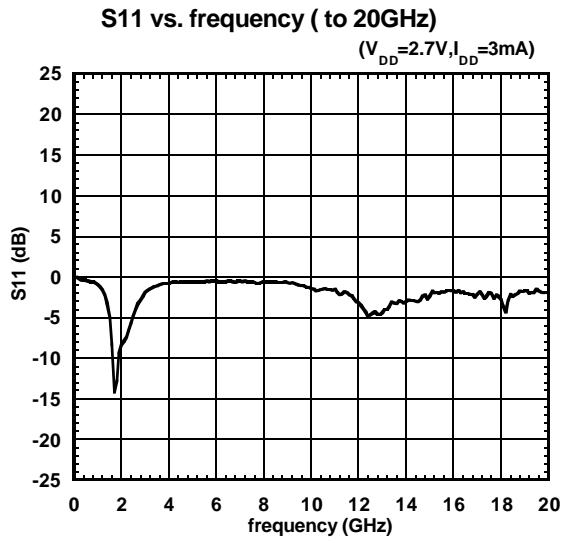

■ TYPICAL CHARACTERISTICS (1.5GHz Band, Low Gain Version)

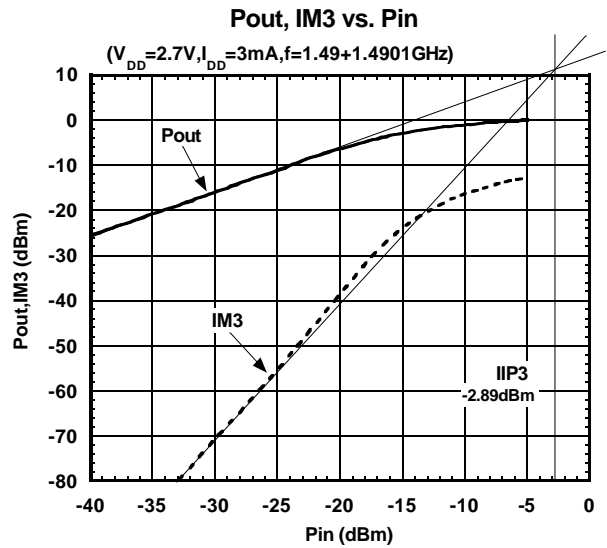
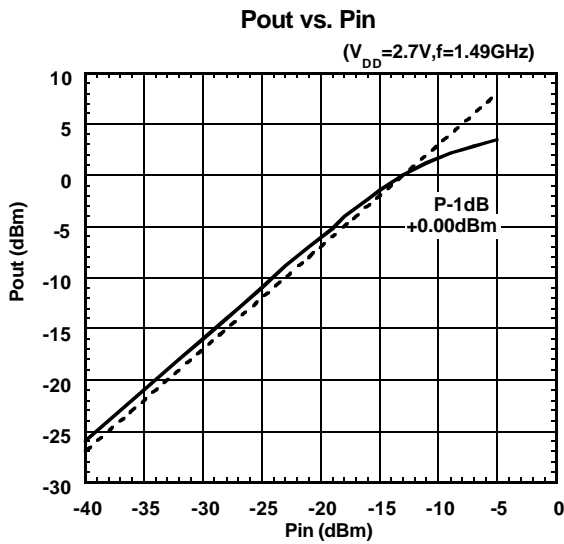
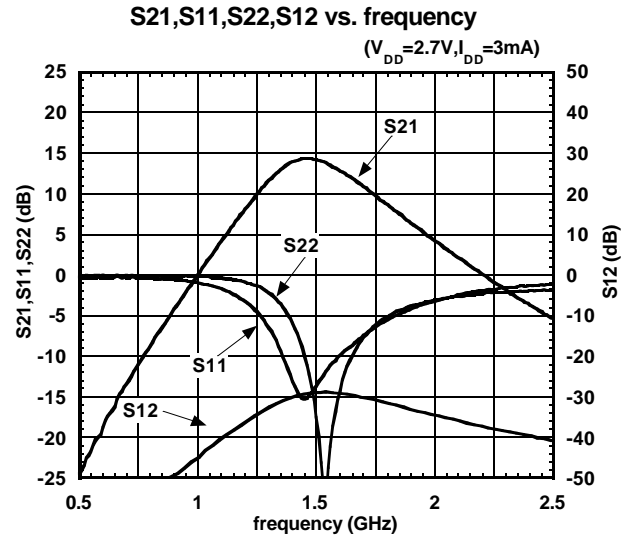
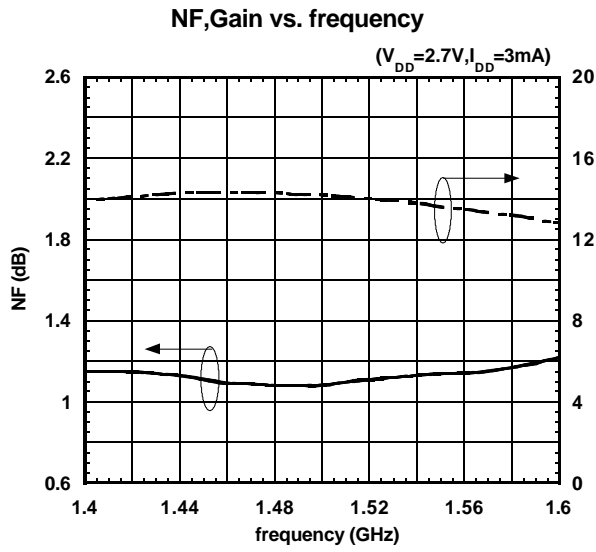

■ TYPICAL CHARACTERISTICS (1.5GHz Band, Low Gain Version)

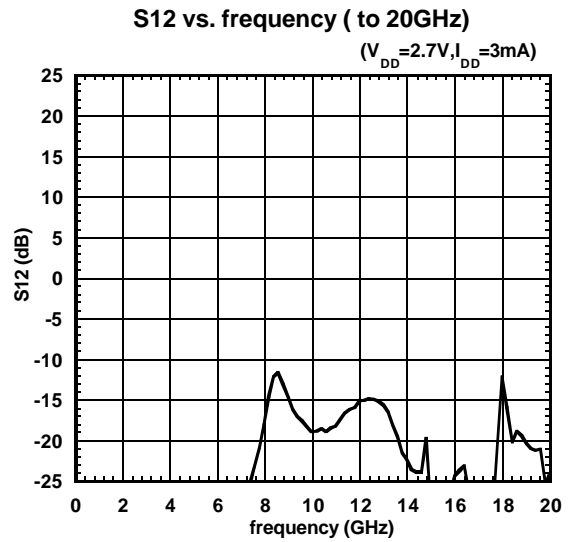
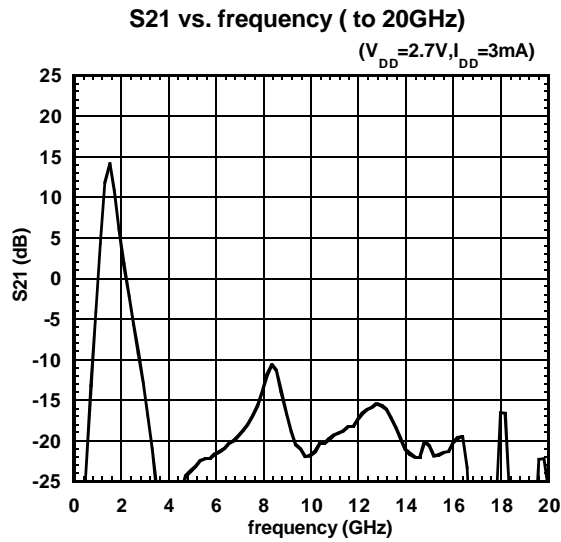
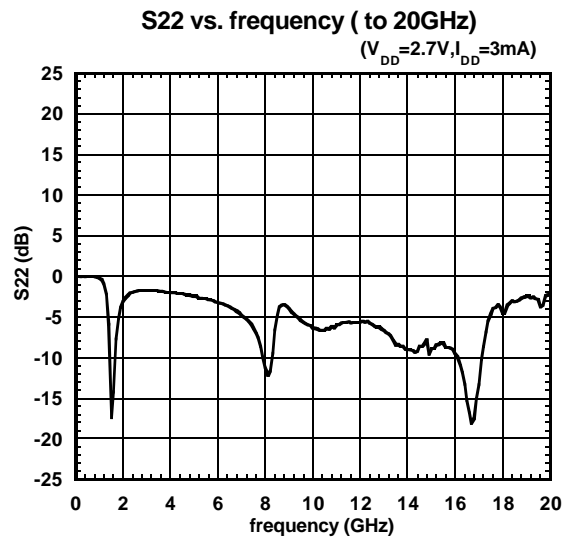
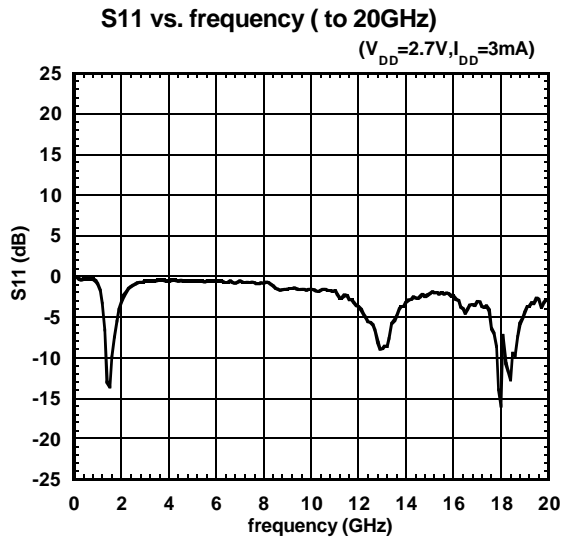

■ TYPICAL CHARACTERISTICS

Scattering Parameter Table

$V_{DD}=2.7V$, $I_{DD}=3mA$, $Z_0=50\Omega$

Freq (GHz)	S11		S21		S12		S22	
	mag (units)	ang (deg)	mag (units)	ang (deg)	mag (units)	ang (deg)	mag (units)	ang (deg)
0.1	1.000	-3.130	2.094	176.987	0.012	-25.995	0.965	-1.855
0.2	0.986	-4.217	2.074	171.002	0.002	110.707	0.967	-1.782
0.3	0.986	-6.161	2.046	165.318	0.007	92.945	0.962	-3.088
0.4	0.972	-8.026	2.012	159.545	0.003	62.606	0.960	-3.801
0.5	0.965	-10.209	1.991	153.712	0.005	103.324	0.961	-5.113
0.6	0.957	-12.032	1.943	147.933	0.004	96.002	0.953	-6.159
0.7	0.943	-13.490	1.909	143.180	0.005	75.842	0.949	-7.623
0.8	0.929	-15.249	1.851	138.232	0.008	90.203	0.940	-9.144
0.9	0.910	-16.014	1.793	133.807	0.006	93.660	0.931	-9.943
1.0	0.903	-16.960	1.765	129.856	0.009	85.810	0.928	-10.876
1.1	0.894	-18.131	1.710	125.443	0.009	95.094	0.931	-12.170
1.2	0.879	-18.645	1.673	121.935	0.010	92.781	0.921	-13.089
1.3	0.864	-19.500	1.636	118.442	0.011	91.381	0.919	-14.156
1.4	0.852	-21.338	1.627	114.415	0.012	100.617	0.919	-14.843
1.5	0.843	-22.810	1.578	110.659	0.014	99.522	0.918	-16.259
1.6	0.826	-24.483	1.541	107.013	0.014	99.175	0.914	-17.088
1.7	0.818	-24.447	1.513	104.077	0.015	100.001	0.918	-18.228
1.8	0.810	-26.509	1.503	100.734	0.016	103.271	0.925	-19.508
1.9	0.801	-27.539	1.489	97.286	0.018	106.687	0.920	-20.507
2.0	0.794	-29.642	1.452	93.725	0.019	108.548	0.921	-21.024
2.1	0.783	-30.807	1.453	90.359	0.020	106.305	0.924	-22.491
2.2	0.782	-33.473	1.421	86.597	0.022	107.071	0.922	-24.160
2.3	0.770	-34.972	1.426	83.223	0.022	107.349	0.920	-25.779
2.4	0.772	-35.870	1.391	79.970	0.026	109.866	0.919	-27.462
2.5	0.760	-37.091	1.397	76.578	0.027	112.983	0.914	-29.724
2.6	0.761	-38.975	1.376	73.069	0.030	109.600	0.920	-32.086
2.7	0.757	-40.916	1.359	68.921	0.031	106.376	0.907	-35.211
2.8	0.756	-41.260	1.322	65.450	0.034	109.318	0.902	-38.255
2.9	0.757	-42.651	1.294	62.030	0.035	106.983	0.893	-41.787
3.0	0.752	-42.892	1.267	58.521	0.036	108.989	0.879	-45.326

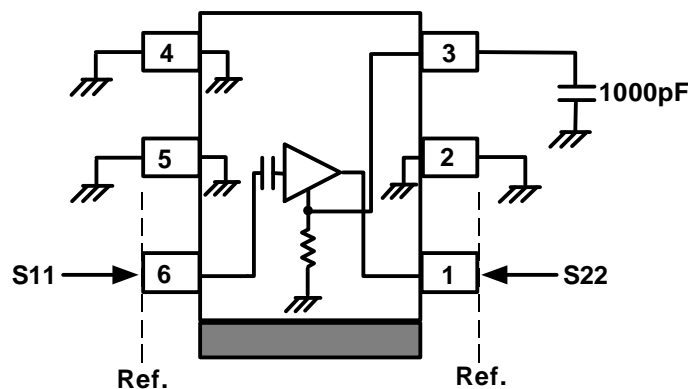

Scattering Parameter
Measurement Circuit

New Japan Radio Co., Ltd.

NJG1107KB2

■ TYPICAL CHARACTERISTICS (1.5GHz Band, Low Gain Version)

Scattering Parameter Table

$V_{DD}=2.7V$, $I_{DD}=3mA$, $Z_0=50\Omega$

Freq (GHz)	S11		S21		S12		S22	
	mag (units)	ang (deg)	mag (units)	ang (deg)	mag (units)	ang (deg)	mag (units)	ang (deg)
0.1	1.011	-1.815	0.619	-137.421	0.006	150.071	0.998	-1.269
0.2	1.023	-4.177	1.049	-141.929	0.005	111.664	0.996	-3.638
0.3	1.027	-6.876	1.402	-152.156	0.004	72.732	0.999	-4.808
0.4	1.036	-10.171	1.681	-164.509	0.008	71.899	0.995	-6.754
0.5	1.029	-13.604	1.843	-176.486	0.006	80.582	0.993	-8.514
0.6	1.027	-17.041	1.967	172.550	0.006	96.630	0.982	-9.913
0.7	1.007	-20.090	1.997	162.037	0.010	79.136	0.983	-12.453
0.8	0.996	-22.496	1.994	153.204	0.009	78.039	0.976	-14.051
0.9	0.978	-25.098	1.967	144.936	0.009	80.635	0.967	-15.603
1.0	0.961	-27.178	1.925	137.106	0.008	73.136	0.967	-17.199
1.1	0.940	-28.800	1.857	131.070	0.010	71.678	0.961	-17.813
1.2	0.923	-30.761	1.825	124.735	0.012	76.438	0.954	-19.024
1.3	0.905	-32.462	1.785	118.431	0.011	77.174	0.948	-21.016
1.4	0.889	-33.815	1.719	113.194	0.010	78.254	0.946	-22.555
1.5	0.877	-34.976	1.679	107.647	0.014	83.456	0.947	-24.779
1.6	0.860	-36.777	1.610	102.741	0.014	73.747	0.947	-26.267
1.7	0.849	-37.774	1.568	98.621	0.014	80.053	0.942	-27.354
1.8	0.834	-39.260	1.534	94.075	0.015	85.009	0.938	-28.669
1.9	0.822	-40.858	1.490	89.890	0.015	83.753	0.939	-29.677
2.0	0.814	-42.312	1.464	85.613	0.017	88.727	0.939	-31.456
2.1	0.801	-43.887	1.435	81.588	0.017	92.695	0.938	-32.776
2.2	0.791	-45.820	1.393	77.520	0.021	98.708	0.939	-34.232
2.3	0.784	-47.584	1.365	73.663	0.019	95.532	0.936	-35.915
2.4	0.773	-49.825	1.332	69.756	0.021	93.049	0.937	-36.454
2.5	0.766	-51.948	1.311	66.211	0.024	93.358	0.940	-38.089
2.6	0.756	-54.101	1.285	62.518	0.025	97.398	0.942	-39.619
2.7	0.753	-56.479	1.260	58.997	0.028	99.809	0.946	-40.798
2.8	0.748	-59.220	1.229	55.237	0.029	93.593	0.949	-42.180
2.9	0.745	-61.715	1.213	51.930	0.031	100.273	0.947	-43.117
3.0	0.744	-64.848	1.189	48.547	0.031	97.032	0.950	-44.659

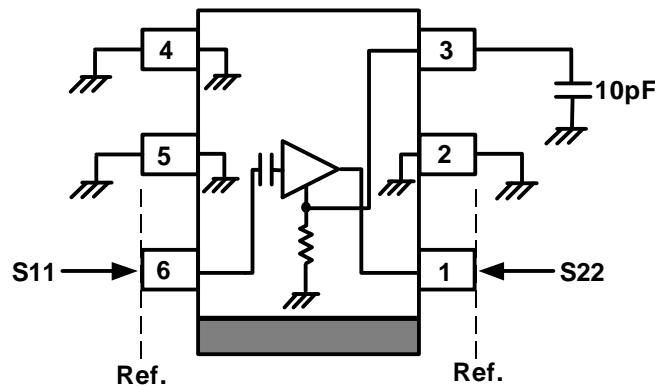

Scattering Parameter
Measurement Circuit

■TEST CIRCUIT 1 (1.5/1.8/1.9GHz Band)

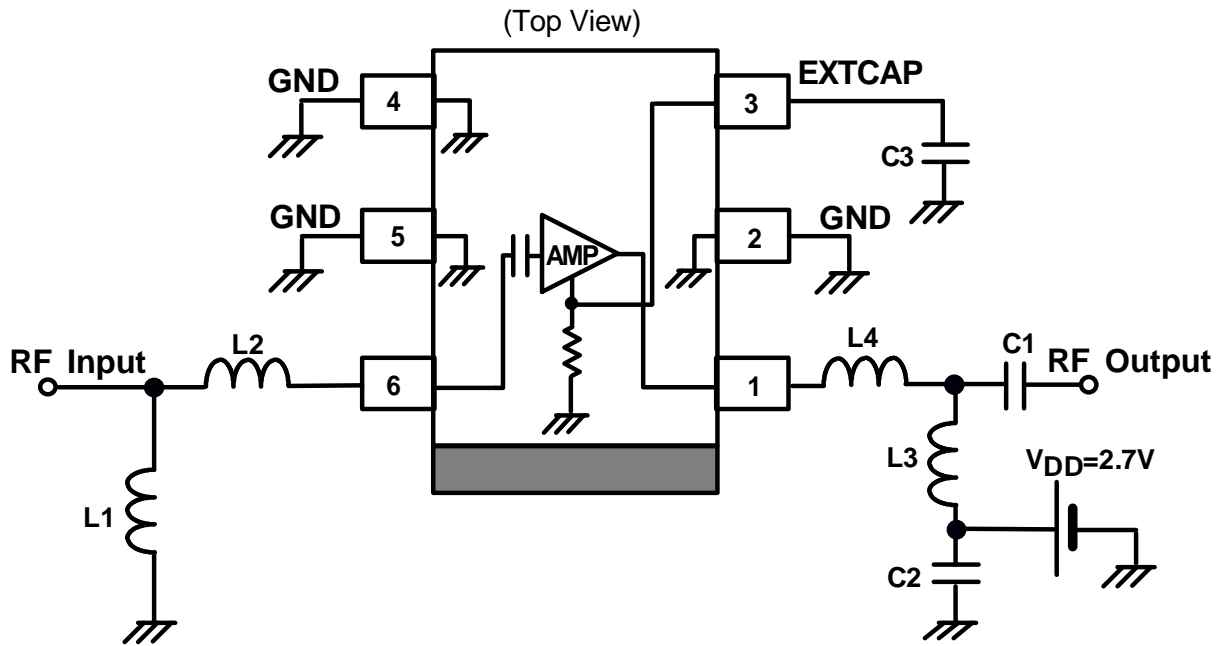

■TEST CIRCUIT 2 (1.5GHz Band, Low Gain Version)

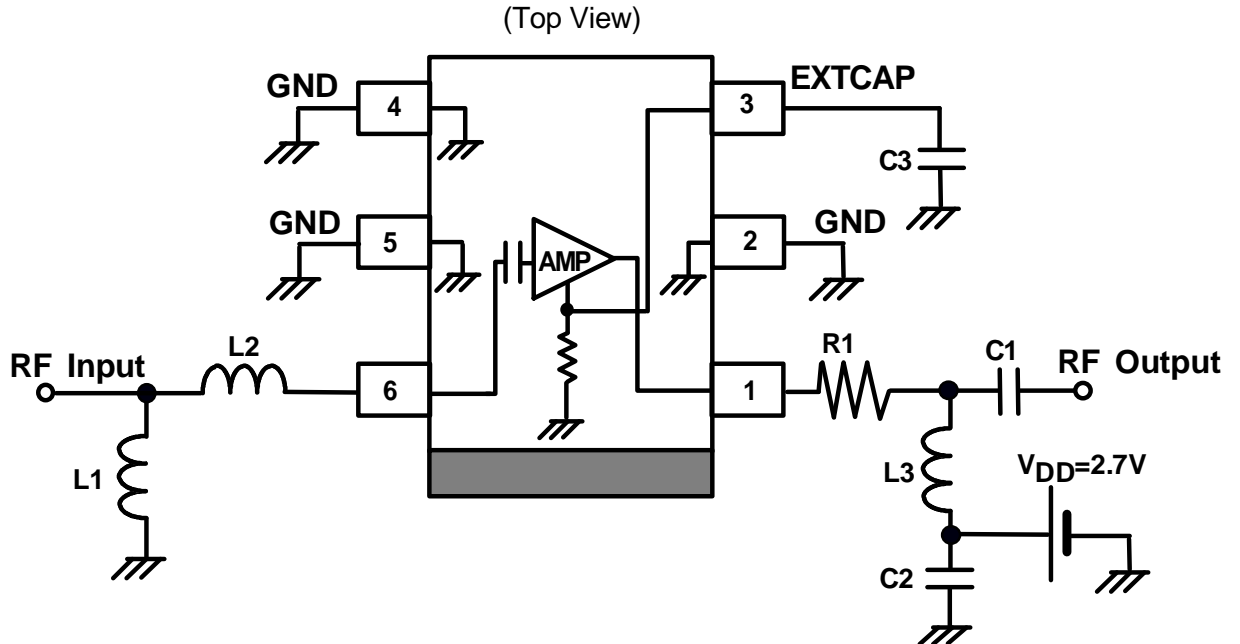

NJG1107KB2

RECOMMENDED PCB DESIGN

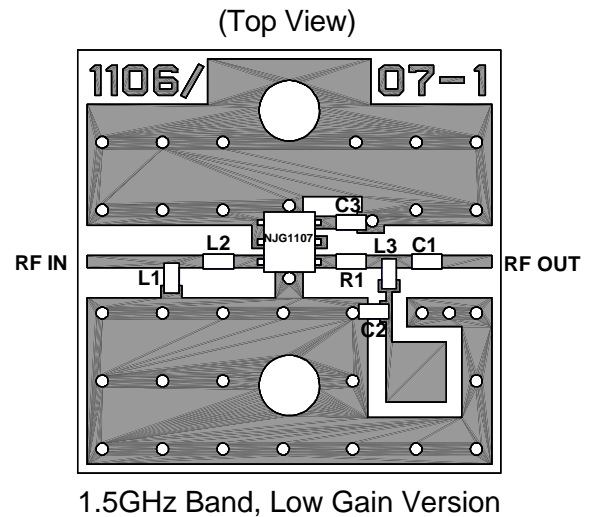
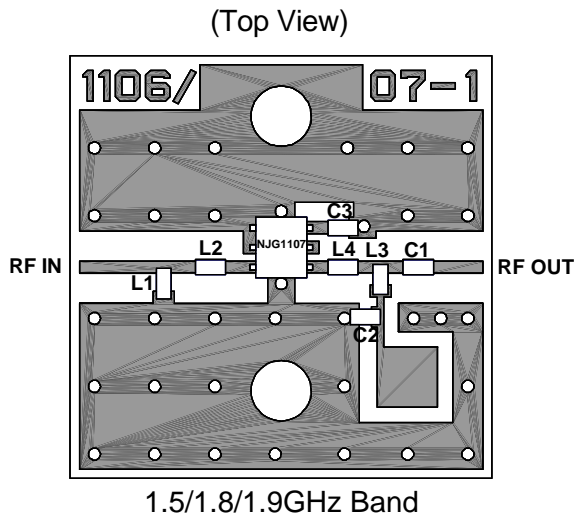

PCB: FR4 $t=0.2\text{mm}$
 MICROSTRIP LINE WIDTH=0.4mm($Z_0=50\Omega$)
 PCB SIZE: 14.0 x 14.0mm

Parts List

Parts ID	Constant				Comment
	1.5GHz Band	1.9GHz Band	1.8GHz Band	1.5GHz Band Low Gain	
L1	10nH	5.6nH	6.8nH	10nH	TAIYO-YUDEN HK1005 Series
L2	12nH	5.6nH	8.2nH	12nH	TAIYO-YUDEN HK1005 Series
L3	5.6nH	3.9nH	6.8nH	6.8nH	TAIYO-YUDEN HK1005 Series
L4	15nH	10nH	12nH	-	TAIYO-YUDEN HK1005 Series
C1	5pF	13pF	30pF	0.75pF	MURATA GRM36 Series
C2	1000pF	1000pF	1000pF	1000pF	MURATA GRM36 Series
C3	1000pF	1000pF	1000pF	10pF	MURATA GRM36 Series
R1	-	-	-	36 Ω	

PACKAGE OUTLINE (FLP6-B2)

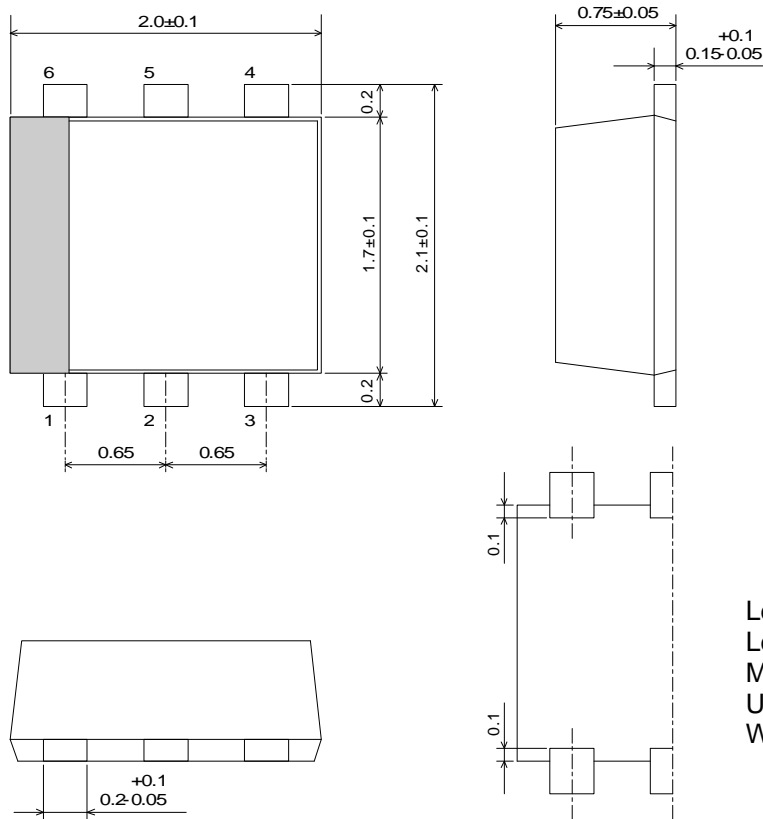

Lead material : Copper
 Lead surface finish : Solder plating
 Molding material : Epoxy resin
 UNIT : mm
 Weight : 6.5mg

Cautions on using this product

This product contains Gallium-Arsenide (GaAs) which is a harmful material.

- Do NOT eat or put into mouth.
- Do NOT dispose in fire or break up this product.
- Do NOT chemically make gas or powder with this product.
- To waste this product, please obey the relating law of your country.

[CAUTION]

The specifications on this databook are only given for information, without any guarantee as regards either mistakes or omissions. The application circuits in this databook are described only to show representative usages of the product and not intended for the guarantee or permission of any right including the industrial rights.

This product may be damaged with electric static discharge (ESD) or spike voltage. Please handle with care to avoid these damages.



Стандарт Электрон Связь

Мы молодая и активно развивающаяся компания в области поставок электронных компонентов. Мы поставляем электронные компоненты отечественного и импортного производства напрямую от производителей и с крупнейших складов мира.

Благодаря сотрудничеству с мировыми поставщиками мы осуществляем комплексные и плановые поставки широчайшего спектра электронных компонентов.

Собственная эффективная логистика и склад в обеспечивает надежную поставку продукции в точно указанные сроки по всей России.

Мы осуществляем техническую поддержку нашим клиентам и предпродажную проверку качества продукции. На все поставляемые продукты мы предоставляем гарантию .

Осуществляем поставки продукции под контролем ВП МО РФ на предприятия военно-промышленного комплекса России , а также работаем в рамках 275 ФЗ с открытием отдельных счетов в уполномоченном банке. Система менеджмента качества компании соответствует требованиям ГОСТ ISO 9001.

Минимальные сроки поставки, гибкие цены, неограниченный ассортимент и индивидуальный подход к клиентам являются основой для выстраивания долгосрочного и эффективного сотрудничества с предприятиями радиоэлектронной промышленности, предприятиями ВПК и научно-исследовательскими институтами России.

С нами вы становитесь еще успешнее!

Наши контакты:

Телефон: +7 812 627 14 35

Электронная почта: sales@st-electron.ru

Адрес: 198099, Санкт-Петербург,
Промышленная ул, дом № 19, литера Н,
помещение 100-Н Офис 331