

FDC6325L Integrated Load Switch

General Description

This device is particularly suited for compact power management in portable electronic equipment where 2.5V to 8V input and 1.8A output current capability are needed. This load switch integrates a small N-Channel power MOSFET (Q1) which drives a large P-Channel power MOSFET (Q2) in one tiny SuperSOT™-6 package.

Features

- $V_{DROPP}=0.2V$ @ $V_{IN}=5V$, $I_L=1.5A$. $R_{(ON)} = 0.13\Omega$
 $V_{DROPP}=0.2V$ @ $V_{IN}=3.3V$, $I_L=1.2A$. $R_{(ON)} = 0.16\Omega$
 $V_{DROPP}=0.2V$ @ $V_{IN}=2.5V$, $I_L=1A$. $R_{(ON)} = 0.18\Omega$.
- SuperSOT™-6 package design using copper lead frame for superior thermal and electrical capabilities.

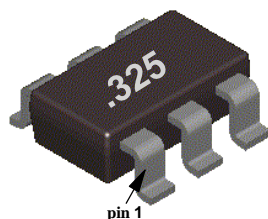

SuperSOT™-6

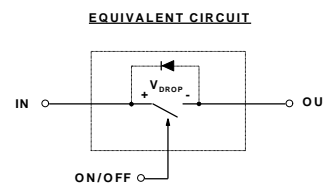
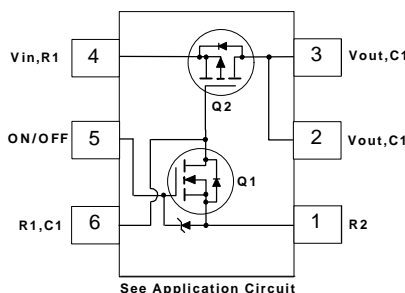

Absolute Maximum Ratings $T_A = 25^\circ\text{C}$ unless otherwise noted

Symbol	Parameter	FDC6325L	Units
V_{IN}	Input Voltage Range	2.5 - 8	V
$V_{ON/OFF}$	On/Off Voltage Range	1.5 - 8	V
I_L	Load Current - Continuous (Note 1)	1.8	A
	- Pulsed (Note 1 & 3)	5	
P_D	Maximum Power Dissipation (Note 2)	0.7	W
T_J, T_{STG}	Operating and Storage Temperature Range	-55 to 150	$^\circ\text{C}$
ESD	Electrostatic Discharge Rating MIL-STD-883D Human Body Model (100pf/1500Ohm)	6	kV

THERMAL CHARACTERISTICS

$R_{\theta JA}$	Thermal Resistance, Junction-to-Ambient (Note 2)	180	$^\circ\text{C/W}$
$R_{\theta JC}$	Thermal Resistance, Junction-to-Case (Note 2)	60	$^\circ\text{C/W}$

Electrical Characteristics (T_A = 25°C unless otherwise noted)

Symbol	Parameter	Conditions	Min	Typ	Max	Units
OFF CHARACTERISTICS						
I _{FL}	Forward Leakage Current	V _{IN} = 8 V, V _{ON/OFF} = 0 V			1	μA
ON CHARACTERISTICS (Note 3)						
V _{DROP}	Conduction Voltage Drop	V _{IN} = 5 V, V _{ON/OFF} = 3.3 V, I _L = 1.5 A		0.15	0.2	V
		V _{IN} = 3.3 V, V _{ON/OFF} = 3.3 V, I _L = 1.2 A		0.145	0.2	
		V _{IN} = 2.5 V, V _{ON/OFF} = 3.3 V, I _L = 1 A		0.13	0.2	
R _(ON)	Q ₂ - Static On-Resistance	V _{GS} = -5 V, I _D = -1.8 A		0.115	0.13	Ω
		V _{GS} = -3.3 V, I _D = -1.6 A		0.13	0.16	
		V _{GS} = -2.5 V, I _D = -1.5 A		0.155	0.18	
I _L	Load Current	V _{DROP} = 0.13 V, V _{IN} = 5 V, V _{ON/OFF} = 3.3 V	1			A
		V _{DROP} = 0.16 V, V _{IN} = 3.3 V, V _{ON/OFF} = 3.3 V	1			
		V _{DROP} = 0.2 V, V _{IN} = 2.5 V, V _{ON/OFF} = 3.3 V	1			

Notes:

- V_{IN}=8V, V_{ON/OFF}=8V, T_A=25°C
- R_{θJA} is the sum of the junction-to-case and case-to-ambient thermal resistance where the case thermal reference is defined as the solder mounting surface of the drain pins. R_{θJC} is guaranteed by design while R_{θCA} is determined by the user's board design.
- Pulse Test: Pulse Width ≤ 300μs, Duty Cycle ≤ 2.0%.

FDC6325L Load Switch Application

APPLICATION CIRCUIT

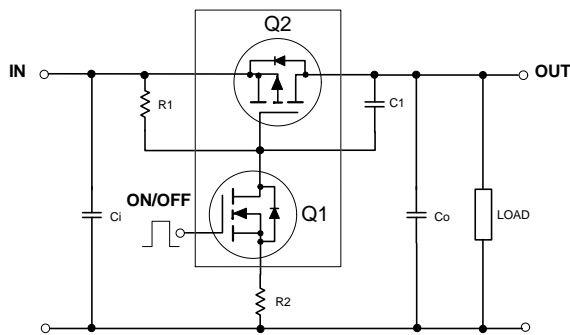

External Component Recommendation

For C₀ ≤ 1μF applications:

First select R₂, 100 - 1kW, for Slew Rate control. C₁ ≤ 1000pF can be added in addition to R₂ for further In-rush current control.

Then select R₁ such that R₁/R₂ ratio maintains between 10 - 100. R₁ is required to turn Q₂ off.

For SPICE simulation, users can download a "FDC6325L.MOD" Spice model from Fairchild Web Site at www.fairchildsemi.com

Typical Electrical Characteristics ($T_A = 25\text{ }^\circ\text{C}$ unless otherwise noted)

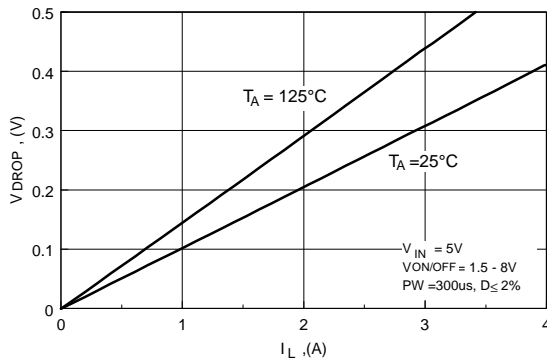

Figure 1. Conduction Voltage Drop Variation with Load Current.

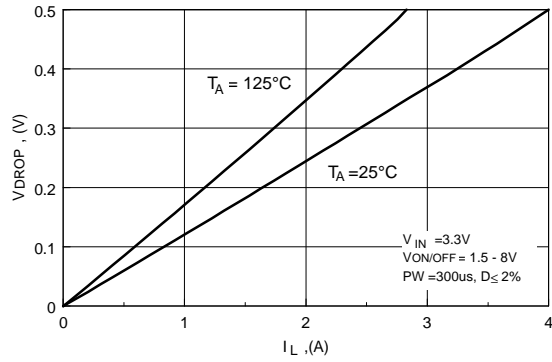

Figure 2. Conduction Voltage Drop Variation with Load Current.

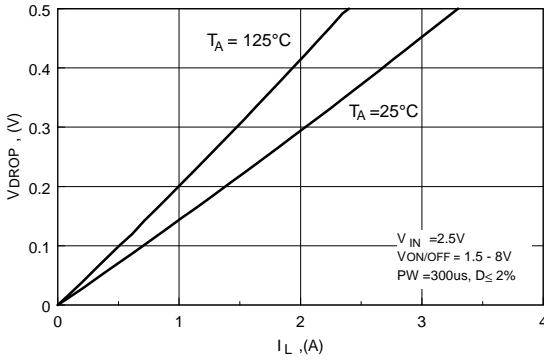

Figure 3. Conduction Voltage Drop Variation with Load Current.

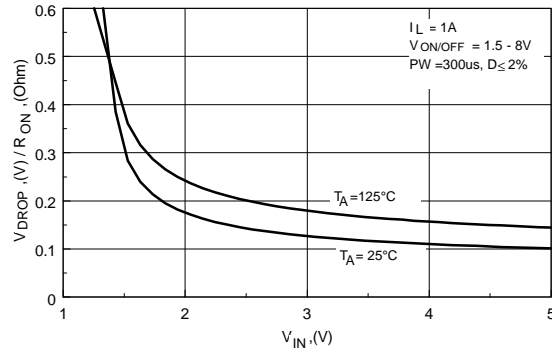

Figure 4. On-Resistance Variation with Input Voltage.

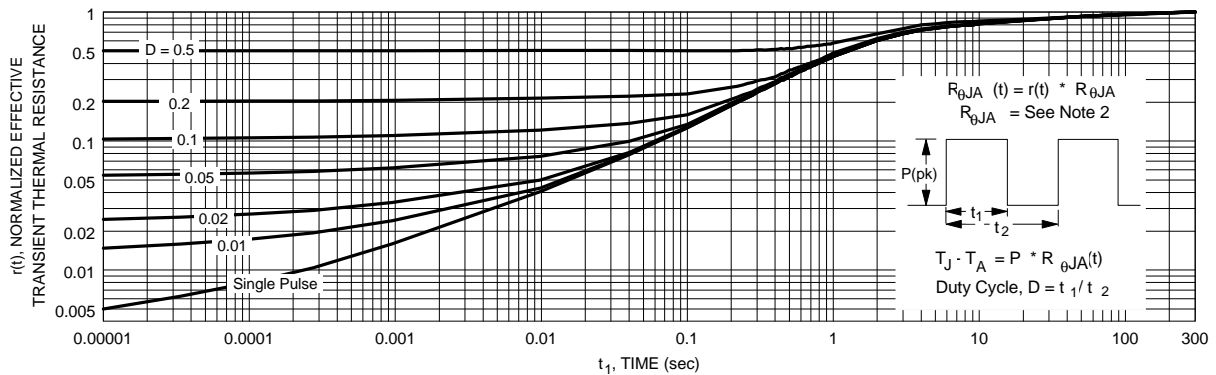

Figure 5. Transient Thermal Response Curve.

Thermal characterization performed on the conditions described in Note 2.
Transient thermal response will change depends on the circuit board design.

TRADEMARKS

The following are registered and unregistered trademarks Fairchild Semiconductor owns or is authorized to use and is not intended to be an exhaustive list of all such trademarks.

ACEx™	ISOPANAR™	TinyLogic™
CoolFET™	MICROWIRE™	UHC™
CROSSVOLT™	POP™	VCX™
E ² CMOS™	PowerTrench™	
FACT™	QFET™	
FACT Quiet Series™	QS™	
FAST®	Quiet Series™	
FASTr™	SuperSOT™-3	
GTO™	SuperSOT™-6	
HiSeC™	SuperSOT™-8	

DISCLAIMER

FAIRCHILD SEMICONDUCTOR RESERVES THE RIGHT TO MAKE CHANGES WITHOUT FURTHER NOTICE TO ANY PRODUCTS HEREIN TO IMPROVE RELIABILITY, FUNCTION OR DESIGN. FAIRCHILD DOES NOT ASSUME ANY LIABILITY ARISING OUT OF THE APPLICATION OR USE OF ANY PRODUCT OR CIRCUIT DESCRIBED HEREIN; NEITHER DOES IT CONVEY ANY LICENSE UNDER ITS PATENT RIGHTS, NOR THE RIGHTS OF OTHERS.

LIFE SUPPORT POLICY

FAIRCHILD'S PRODUCTS ARE NOT AUTHORIZED FOR USE AS CRITICAL COMPONENTS IN LIFE SUPPORT DEVICES OR SYSTEMS WITHOUT THE EXPRESS WRITTEN APPROVAL OF FAIRCHILD SEMICONDUCTOR CORPORATION. As used herein:

1. Life support devices or systems are devices or systems which, (a) are intended for surgical implant into the body, or (b) support or sustain life, or (c) whose failure to perform when properly used in accordance with instructions for use provided in the labeling, can be reasonably expected to result in significant injury to the user.
2. A critical component is any component of a life support device or system whose failure to perform can be reasonably expected to cause the failure of the life support device or system, or to affect its safety or effectiveness.

PRODUCT STATUS DEFINITIONS

Definition of Terms

Datasheet Identification	Product Status	Definition
Advance Information	Formative or In Design	This datasheet contains the design specifications for product development. Specifications may change in any manner without notice.
Preliminary	First Production	This datasheet contains preliminary data, and supplementary data will be published at a later date. Fairchild Semiconductor reserves the right to make changes at any time without notice in order to improve design.
No Identification Needed	Full Production	This datasheet contains final specifications. Fairchild Semiconductor reserves the right to make changes at any time without notice in order to improve design.
Obsolete	Not In Production	This datasheet contains specifications on a product that has been discontinued by Fairchild semiconductor. The datasheet is printed for reference information only.



Стандарт Электрон Связь

Мы молодая и активно развивающаяся компания в области поставок электронных компонентов. Мы поставляем электронные компоненты отечественного и импортного производства напрямую от производителей и с крупнейших складов мира.

Благодаря сотрудничеству с мировыми поставщиками мы осуществляем комплексные и плановые поставки широчайшего спектра электронных компонентов.

Собственная эффективная логистика и склад в обеспечивает надежную поставку продукции в точно указанные сроки по всей России.

Мы осуществляем техническую поддержку нашим клиентам и предпродажную проверку качества продукции. На все поставляемые продукты мы предоставляем гарантию .

Осуществляем поставки продукции под контролем ВП МО РФ на предприятия военно-промышленного комплекса России , а также работаем в рамках 275 ФЗ с открытием отдельных счетов в уполномоченном банке. Система менеджмента качества компании соответствует требованиям ГОСТ ISO 9001.

Минимальные сроки поставки, гибкие цены, неограниченный ассортимент и индивидуальный подход к клиентам являются основой для выстраивания долгосрочного и эффективного сотрудничества с предприятиями радиоэлектронной промышленности, предприятиями ВПК и научно-исследовательскими институтами России.

С нами вы становитесь еще успешнее!

Наши контакты:

Телефон: +7 812 627 14 35

Электронная почта: sales@st-electron.ru

Адрес: 198099, Санкт-Петербург,
Промышленная ул, дом № 19, литера Н,
помещение 100-Н Офис 331