

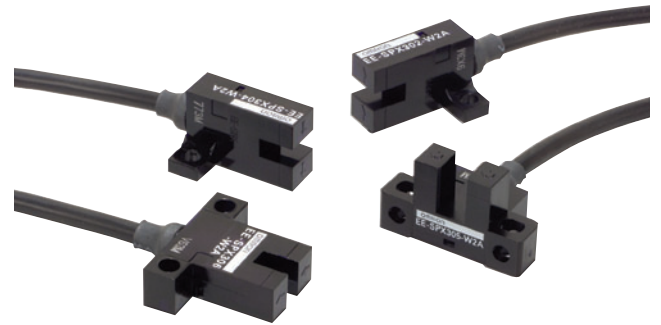

EE-SPX-W

Photomicrosensor with built-in amplifier and attached cable reduces external light interference.





- Light modulation effectively reduces external light interference.
- Wide operation voltage range: 5 to 24 VDC
- Easy operation monitoring with bright light indicator.

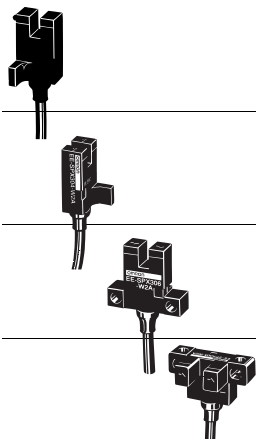

 Be sure to read *Safety Precautions* on page 3.

Ordering Information

 Infrared light

Appearance	Sensing method	Sensing distance (slot width)		Output type	Output configuration	Cable length	Model
	Through-beam type		3.6 mm	NPN output	Dark-ON	1 m	EE-SPX302-W2A 1M
					Light-ON		EE-SPX402-W2A 1M
			3.6 mm		Dark-ON		EE-SPX304-W2A 1M
					Light-ON		EE-SPX404-W2A 1M
			3.6 mm		Dark-ON		EE-SPX306-W2A 1M
					Light-ON		EE-SPX406-W2A 1M
			5 mm		Dark-ON		EE-SPX305-W2A 1M*
					Light-ON		EE-SPX405-W2A 1M*

* These models (EE-SPX305/405-W2A only) are not conformed to CE standards.

Ratings and Specifications

Item	Models	EE-SPX302-W2A, EE-SPX402-W2A EE-SPX304-W2A, EE-SPX404-W2A EE-SPX306-W2A, EE-SPX406-W2A	EE-SPX305-W2A EE-SPX405-W2A
Sensing distance		3.6 mm (slot width)	5 mm (slot width)
Sensing object		Opaque: 1 × 0.5 mm min.	Opaque: 2 × 0.8 mm min.
Differential distance		0.05 mm max.	
Light source		GaAs infrared LED (pulse lighting) with a peak wavelength of 940 nm	
Indicator *1		Light indicator (red)	
Supply voltage		5 to 24 VDC ±10%, ripple (p-p): 5% max.	
Current consumption		Average: 15 mA max.; Peak: 50 mA max.	
Control output		NPN voltage output: Load power supply voltage: 5 to 24 VDC Load current: 80 mA max. OFF current: 0.5 mA max. 80 mA load current with a residual voltage of 1.0 V max. 10 mA load current with a residual voltage of 0.4 V max.	
Response frequency *2		500 Hz min.	
Ambient illumination		3,000 lx max. with incandescent light or sunlight on the surface of the receiver	
Ambient temperature range		Operating: -10 to +55°C Storage: -25 to +65°C	
Ambient humidity range		Operating: 5% to 85% Storage: 5% to 95%	
Vibration resistance		Destruction: 10 to 55 Hz, 1.5-mm double amplitude for 2 h each in X, Y, and Z directions	
Shock resistance		Destruction: 500 m/s ² for 3 times each in X, Y, and Z directions	
Degree of protection		IEC IP50	
Connecting method		Pre-wired (standard cable length: 1 m)	
Weight		18.5 g	
Material	Case	Polycarbonate	
	Holder		

*1. The indicator is a GaP red LED (peak wavelength: 700 nm).

*2. The response frequency was measured by detecting the following rotating disk.

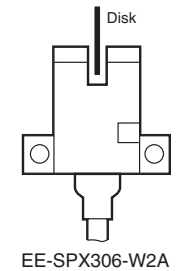
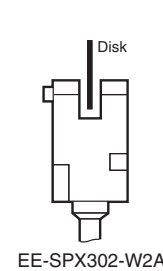
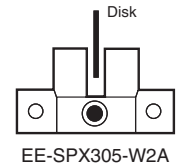
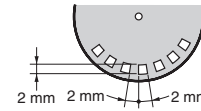

I/O Circuit Diagrams

NPN Output

Model	Output configuration	Timing charts	Output circuit
EE-SPX402-W2A EE-SPX404-W2A EE-SPX405-W2A EE-SPX406-W2A	Light-ON	<p>Incident Interrupted</p> <p>Light indicator (red) ON OFF</p> <p>Output transistor ON OFF</p> <p>Load 1 (relay) Operates Releases</p> <p>Load 2 H L</p>	<p>* Voltage output (when the sensor is connected to a transistor circuit)</p>
EE-SPX302-W2A EE-SPX304-W2A EE-SPX305-W2A EE-SPX306-W2A	Dark-ON	<p>Incident Interrupted</p> <p>Light indicator (red) ON OFF</p> <p>Output transistor ON OFF</p> <p>Load 1 (relay) Operates Releases</p> <p>Load 2 H L</p>	

Engineering Data (Typical)

Sensing Position Characteristics

EE-SPX302-W2A
 EE-SPX304-W2A
 EE-SPX306-W2A

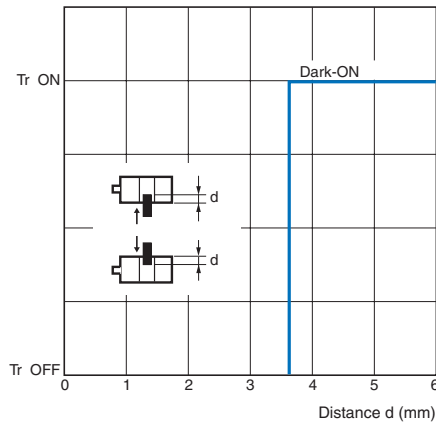

EE-SPX302-W2A
 EE-SPX304-W2A
 EE-SPX306-W2A

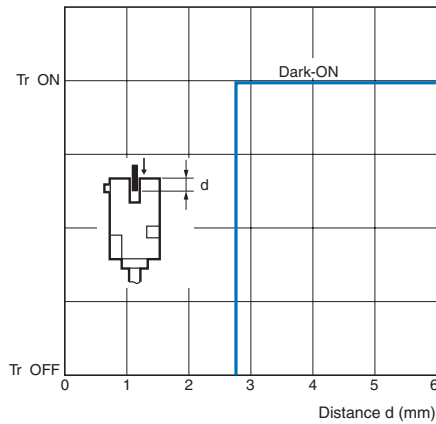

EE-SPX305-W2A

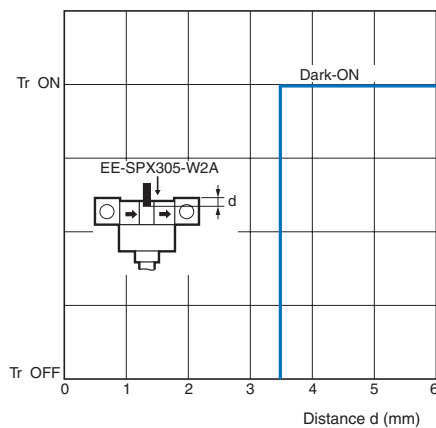

EE-SPX305-W2A

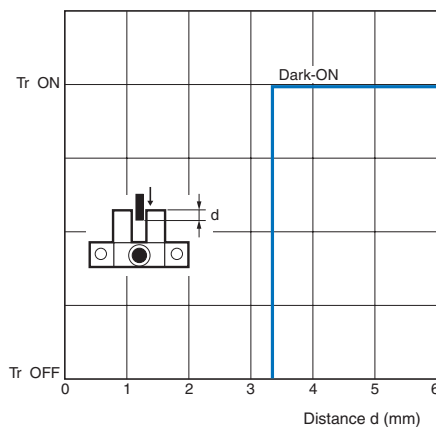

Safety Precautions

Refer to *Warranty and Limitations of Liability*.

WARNING

This product is not designed or rated for ensuring safety of persons either directly or indirectly. Do not use it for such purposes.



Precautions for Correct Use

Make sure that this product is used within the rated ambient environment conditions.

● Wiring

- When extending the cable, use an extension cable with conductors having a total cross-section area of 0.3 mm². The total cable length must be 2 m maximum.
- To use a cable length longer than 2 m, attach a capacitor with a capacitance of approximately 10 μF to the wires as shown below. The distance between the terminal and the capacitor must be within 2 m. (Use a capacitor with a dielectric strength that is at least twice the Sensor's power supply voltage.)

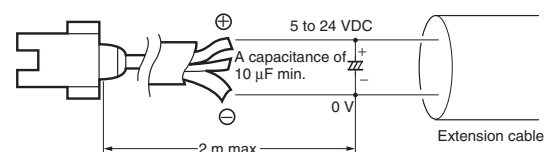

- Make sure the total length of the power cable connected to the product is less than 10 m even if a capacitor is inserted.

(Unit: mm)

Dimensions

Tolerance class IT16 applies to dimensions in this datasheet unless otherwise specified.

EE-SPX302-W2A EE-SPX402-W2A

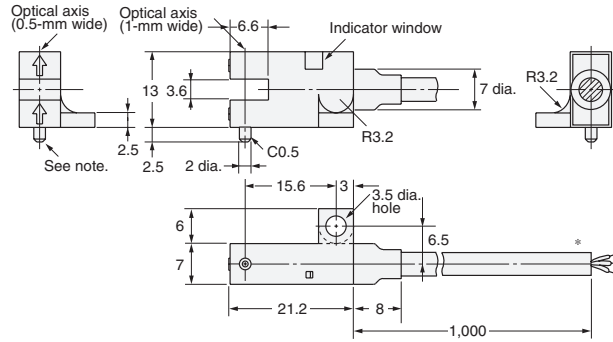
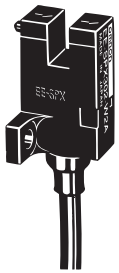

* Vinyl-insulated round cable of 3.5 dia., 3 cores, (0.14 mm² with 1.0-dia. insulator); Standard length: 1 m

Note: The lug is used to prevent turning and to indicate the optical axis.
When installing, make a fixed hole of 2.1 to 2.3 mm dia.

EE-SPX304-W2A EE-SPX404-W2A

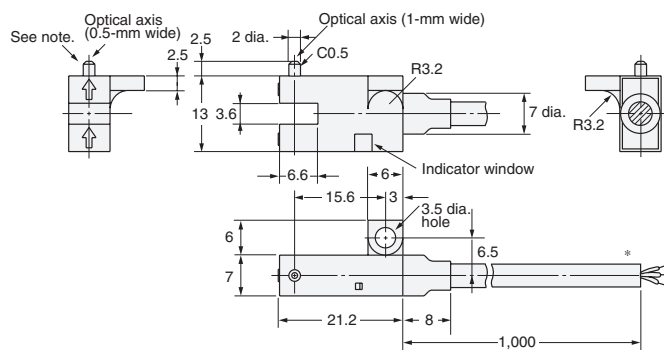

* Vinyl-insulated round cable of 3.5 dia., 3 cores, (0.14 mm² with 1.0-dia. insulator); Standard length: 1 m

Note: The lug is used to prevent turning and to indicate the optical axis.
When installing, make a fixed hole of 2.1 to 2.3 mm dia.

EE-SPX306-W2A EE-SPX406-W2A

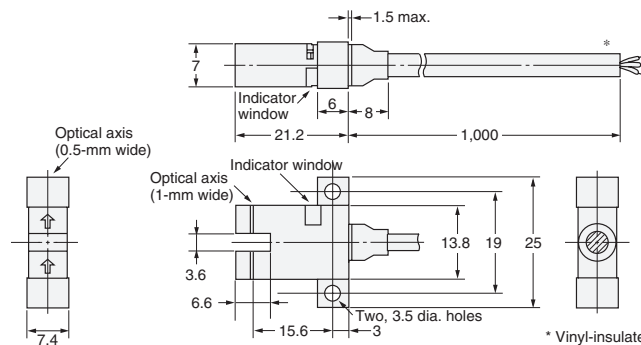
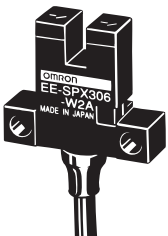

* Vinyl-insulated round cable of 3.5 dia., 3 cores, (0.14 mm² with 1.0-dia. insulator); Standard length: 1 m

EE-SPX305-W2A EE-SPX405-W2A

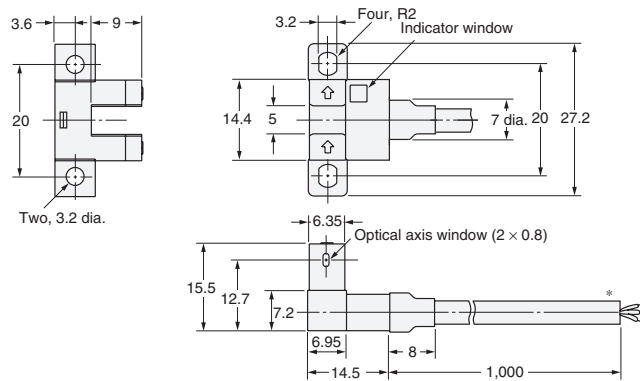
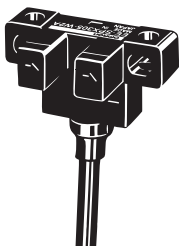

* Vinyl-insulated round cable of 3.5 dia., 3 cores, (0.14 mm² with 1.0-dia. insulator); Standard length: 1 m

Read and Understand This Catalog

Please read and understand this catalog before purchasing the products. Please consult your OMRON representative if you have any questions or comments.

Warranty and Limitations of Liability

WARRANTY

OMRON's exclusive warranty is that the products are free from defects in materials and workmanship for a period of one year (or other period if specified) from date of sale by OMRON.

OMRON MAKES NO WARRANTY OR REPRESENTATION, EXPRESS OR IMPLIED, REGARDING NON-INFRINGEMENT, MERCHANTABILITY, OR FITNESS FOR PARTICULAR PURPOSE OF THE PRODUCTS. ANY BUYER OR USER ACKNOWLEDGES THAT THE BUYER OR USER ALONE HAS DETERMINED THAT THE PRODUCTS WILL SUITABLY MEET THE REQUIREMENTS OF THEIR INTENDED USE. OMRON DISCLAIMS ALL OTHER WARRANTIES, EXPRESS OR IMPLIED.

LIMITATIONS OF LIABILITY

OMRON SHALL NOT BE RESPONSIBLE FOR SPECIAL, INDIRECT, OR CONSEQUENTIAL DAMAGES, LOSS OF PROFITS OR COMMERCIAL LOSS IN ANY WAY CONNECTED WITH THE PRODUCTS, WHETHER SUCH CLAIM IS BASED ON CONTRACT, WARRANTY, NEGLIGENCE, OR STRICT LIABILITY.

In no event shall the responsibility of OMRON for any act exceed the individual price of the product on which liability is asserted.

IN NO EVENT SHALL OMRON BE RESPONSIBLE FOR WARRANTY, REPAIR, OR OTHER CLAIMS REGARDING THE PRODUCTS UNLESS OMRON'S ANALYSIS CONFIRMS THAT THE PRODUCTS WERE PROPERLY HANDLED, STORED, INSTALLED, AND MAINTAINED AND NOT SUBJECT TO CONTAMINATION, ABUSE, MISUSE, OR INAPPROPRIATE MODIFICATION OR REPAIR.

Application Considerations

SUITABILITY FOR USE

OMRON shall not be responsible for conformity with any standards, codes, or regulations that apply to the combination of products in the customer's application or use of the products.

At the customer's request, OMRON will provide applicable third party certification documents identifying ratings and limitations of use that apply to the products. This information by itself is not sufficient for a complete determination of the suitability of the products in combination with the end product, machine, system, or other application or use.

The following are some examples of applications for which particular attention must be given. This is not intended to be an exhaustive list of all possible uses of the products, nor is it intended to imply that the uses listed may be suitable for the products:

- Outdoor use, uses involving potential chemical contamination or electrical interference, or conditions or uses not described in this catalog.
- Nuclear energy control systems, combustion systems, railroad systems, aviation systems, medical equipment, amusement machines, vehicles, safety equipment, and installations subject to separate industry or government regulations.
- Systems, machines, and equipment that could present a risk to life or property.

Please know and observe all prohibitions of use applicable to the products.

NEVER USE THE PRODUCTS FOR AN APPLICATION INVOLVING SERIOUS RISK TO LIFE OR PROPERTY WITHOUT ENSURING THAT THE SYSTEM AS A WHOLE HAS BEEN DESIGNED TO ADDRESS THE RISKS, AND THAT THE OMRON PRODUCTS ARE PROPERLY RATED AND INSTALLED FOR THE INTENDED USE WITHIN THE OVERALL EQUIPMENT OR SYSTEM.

PROGRAMMABLE PRODUCTS

OMRON shall not be responsible for the user's programming of a programmable product, or any consequence thereof.

Disclaimers

CHANGE IN SPECIFICATIONS

Product specifications and accessories may be changed at any time based on improvements and other reasons.

It is our practice to change model numbers when published ratings or features are changed, or when significant construction changes are made. However, some specifications of the products may be changed without any notice. When in doubt, special model numbers may be assigned to fix or establish key specifications for your application on your request. Please consult with your OMRON representative at any time to confirm actual specifications of purchased products.

DIMENSIONS AND WEIGHTS

Dimensions and weights are nominal and are not to be used for manufacturing purposes, even when tolerances are shown.

PERFORMANCE DATA

Performance data given in this catalog is provided as a guide for the user in determining suitability and does not constitute a warranty. It may represent the result of OMRON's test conditions, and the users must correlate it to actual application requirements. Actual performance is subject to the OMRON Warranty and Limitations of Liability.

ERRORS AND OMISSIONS

The information in this document has been carefully checked and is believed to be accurate; however, no responsibility is assumed for clerical, typographical, or proofreading errors, or omissions.

2010.8

In the interest of product improvement, specifications are subject to change without notice.

OMRON Corporation
Industrial Automation Company

<http://www.ia.omron.com/>

(c)Copyright OMRON Corporation 2010 All Right Reserved.



Стандарт Электрон Связь

Мы молодая и активно развивающаяся компания в области поставок электронных компонентов. Мы поставляем электронные компоненты отечественного и импортного производства напрямую от производителей и с крупнейших складов мира.

Благодаря сотрудничеству с мировыми поставщиками мы осуществляем комплексные и плановые поставки широчайшего спектра электронных компонентов.

Собственная эффективная логистика и склад в обеспечивает надежную поставку продукции в точно указанные сроки по всей России.

Мы осуществляем техническую поддержку нашим клиентам и предпродажную проверку качества продукции. На все поставляемые продукты мы предоставляем гарантию .

Осуществляем поставки продукции под контролем ВП МО РФ на предприятия военно-промышленного комплекса России , а также работаем в рамках 275 ФЗ с открытием отдельных счетов в уполномоченном банке. Система менеджмента качества компании соответствует требованиям ГОСТ ISO 9001.

Минимальные сроки поставки, гибкие цены, неограниченный ассортимент и индивидуальный подход к клиентам являются основой для выстраивания долгосрочного и эффективного сотрудничества с предприятиями радиоэлектронной промышленности, предприятиями ВПК и научно-исследовательскими институтами России.

С нами вы становитесь еще успешнее!

Наши контакты:

Телефон: +7 812 627 14 35

Электронная почта: sales@st-electron.ru

Адрес: 198099, Санкт-Петербург,
Промышленная ул, дом № 19, литера Н,
помещение 100-Н Офис 331