

# Silicon Beam-Lead and Chip Schottky Barrier Mixer Diodes

 Alpha

DMB, DME, DMF and DMJ Series

## Features

- Ideal for MIC
- Low 1/f Noise
- Low Intermodulation Distortion
- Low Turn On
- Hermetically Sealed Packages
- SPC Controlled Wafer Fabrication

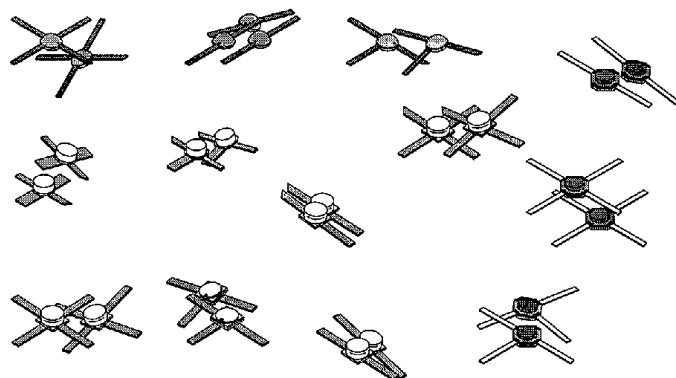

## Description

Alpha beam-lead and chip schottky barrier mixer diodes are designed for applications through 40 GHz in Ka-band. The beam-lead design eliminates the problem of bonding to the very small junction area that is characteristic of the low capacitance involved in microwave devices.

Beam-lead schottky barrier mixer diodes are made by deposition of a suitable barrier metal on an epitaxial silicon substrate from the junction. The process and choice of materials result in low series resistance along with a narrow spread of capacitance values for close impedance control.

A variety of forward knees is available, ranging from a low value for low, or starved, local oscillator drive levels to a higher value for high drive, low intermode mixer applications. The beam-lead diodes are available in a wide range of packages as shown. Capacitance ranges and series resistances are comparable with the packaged devices that are available through K-band. The unmounted diodes are especially well suited for use in microwave integrated circuits. The mounted devices can be easily inserted as hybrid elements in stripline, microstrip or other such circuitry.

Beam-lead and chip schottky barrier diodes are categorized by noise figure for mixer applications in four frequency ranges: S, X, Ku and Ka-bands.

However, they can also be used as modulators, high speed switches and low power limiters.

Several types of semiconductor-barrier metal systems are available, thus allowing proper selection for optimum mixer design. For most applications the N-type silicon, low drive types are preferable, especially for starved LO mixers.

Beam-lead diodes are ideally suited for balanced mixers, since they exhibit low parasitics and are extremely uniform. A typical  $V_F$  vs.  $I_F$  curve is shown in Figure 1. Typical noise figures vs LO drive is shown in Figure 2 for single N-type, low drive diode types.

Refer to the Application Notes section for more information on device selections.

## Maximum Ratings

Storage Temperature:	-65°C/+175°C
Operating Temperature:	-65°C/+175°C
Dissipated Power:	75 mW/Junction
Max Current:	100 mA
Reverse Voltage:	-

Band	Frequencies
S	2 to 4
C	4 to 8
X	8.2 to 12.4
Ku	12.4 to 18.0

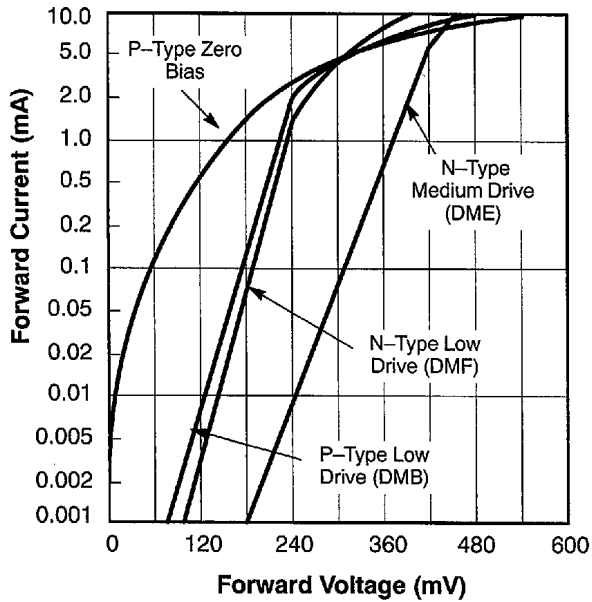

Figure 1. Typical Forward DC Characteristics Curves – Voltage vs. Current

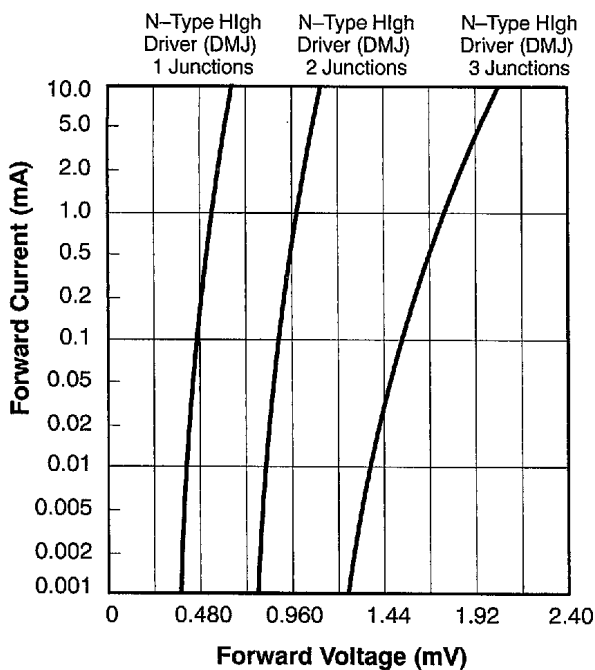

Figure 2. Typical Forward DC Characteristic Curves – Voltage vs. Current

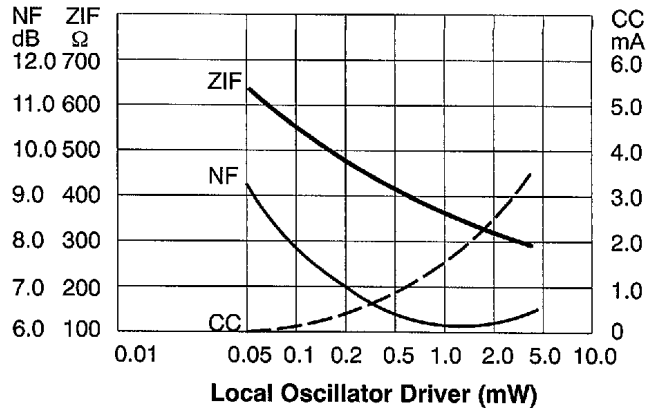

Figure 3. Typical X-Band Low Drive Mixer Diode – RF Parameters vs. Local Oscillator Drive

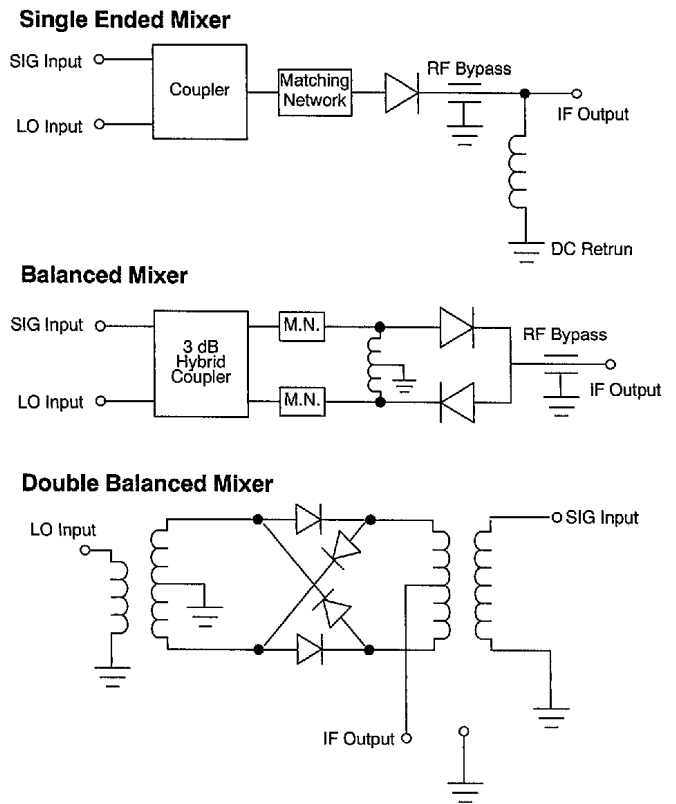

Figure 4. Typical Mixer Circuits

### Ordering Information

To order a packaged diode, simply append the part number to the package outline number. For example, a Medium Drive Ring Quad, Ku band (part number DME2859) in a 464-002 package would be ordered as DME2859-464-002.

## Beam-Lead (Singles), N-Type, Low, Medium, High Drive



Freq. Band	C <sub>J</sub> 0V 1 MHz pF		R <sub>S</sub> 10 mA Ω	V <sub>B</sub> 10 μA Ω	V <sub>F</sub> 1mA mV		Drive Level	Beam Lead	Epoxy		Hermetic	
	Min	Max	Max	Min	Min	Max		491-011	130-011	464-011	325-011	364-011
<b>S</b>	0.30	0.50	5	2	220	290	Low	DMF2820	DMF5845		DMF5079	DMF4365
				3	300	400	Med	DME2127	DME3128		DME3006	DME3124
				4	500	600	High	DMJ2823	DMJ6784		DMJ6785	DMJ3153
<b>X</b>	0.15	0.30	8	2	250	310	Low	DMF2821	DMF5827		DMF4035	DMF3064
				3	325	425	Med	DME2957	DME3055		DME3005	DME3125
				4	550	650	High	DMJ2777	DMJ6786		DMJ6789	DMJ3154
<b>KU</b>	0.05	0.15	13	2	270	330	Low	DMF2344	DMF6022	DMF3444	DMF3363	DMF3065
				3	350	450	Med	DME2333	DME3056	DME3433	DME3316	DME3126
				4	500	680	High	DMJ2824	DMJ6670	DMJ3439		DMJ3155
<b>K</b>	-	0.1	18	2	270	350	Low	DMF2822		DMF3445		
				3	375	550	Med	DME2458		DME3434		
				4	600	700	High	DMJ2825		DMJ3440		

## Beam-Lead (Series Pair), N-Type, Low, Medium, High Drive



Freq. Band	C <sub>J</sub> 0V 1 MHz pF		R <sub>S</sub> 10 mA Ω	V <sub>B</sub> 10 μA Ω	V <sub>F</sub> 1mA mV		Drive Level	Beam Lead	Epoxy		Hermetic		
	Min	Max	Max	Min	Min	Max		504-012	131-012	464-012	325-012	364-012	
<b>S</b>	0.30	0.50	5	2	220	290	Low	DMF2835	DMF5846			DMF6576	
				3	300	400	Med	DME2050	DME3012			DME3021	
				4	500	600	High	DMJ2092	DMJ6531			DMJ4783	
<b>X</b>	0.15	0.30	8	2	250	310	Low	DMF2826	DMF6460			DMF6704	DMF4526
				3	325	425	Med	DME2829	DME3013			DME3022	DME3025
				4	550	650	High	DMJ2093	DMJ4317			DMJ3090	DMJ4760
<b>KU</b>	0.05	0.15	13	2	270	330	Low	DMF2827	DMF6459	DMF3446			DMF4734
				3	350	450	Med	DME2830	DME3014	DME3435			DME3026
				4	500	680	High	DMJ2832	DMJ3081	DMJ3441			DMJ3089
<b>K</b>	-	0.1	18	2	270	350	Low	DMF2828		DMF3430			
				3	375	550	Med	DME2831		DME3436			
				4	600	700	High	DMJ2833		DMJ3442			

## Beam-Lead (Common Cathode), N-Type, Low, Medium, High Drive

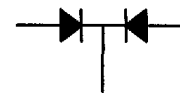

Freq. Band	C <sub>J</sub> 0V 1 MHz pF		R <sub>S</sub> 10 mA Ω	V <sub>B</sub> 10 μA Ω	V <sub>F</sub> 1mA mV		Drive Level	Beam Lead	Epoxy		Hermetic		
	Min	Max	Max	Min	Min	Max		504-013	131-013	464-013	325-013	364-013	
S	0.30	0.50	5	2	220	290	Low	DMF2182	DMF4308			DMF3448	
				3	300	400	Med	DME2205					
				4	500	600	High	DMJ2208	DMJ4715				
X	0.15	0.30	8	2	250	310	Low	DMF2183	DMF3323				
				3	325	425	Med	DME2206					
				4	550	650	High	DMJ2209			DMJ3517	DMJ3328	
KU	0.05	0.15	13	2	270	330	Low	DMF2184	DMF3314				
				3	350	450	Med	DME2207					
				4	500	680	High	DMJ2210					
K	-	0.1	18	2	270	350	Low	DMF2834					
				3	375	550	Med	DME2835					
				4	600	700	High	DMJ2836					

## Beam-Lead (Anti-Parallel Pairs), N-Type, Low, Medium, High Drive

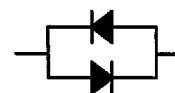

Freq. Band	C <sub>J</sub> 0V 1 MHz pF		R <sub>S</sub> 10 mA Ω	V <sub>B</sub> 10 μA Ω	V <sub>F</sub> 1mA mV		Drive Level	Beam Lead		
	Min	Max	Max	Min	Min	Max		525-025	130-025	325-025
S	0.30	0.50	5	2	220	290	Low	DMF2185	DMF3226	DMF3291
				3	300	400	Med	DM2282	DME3270	DME3278
				4	500	600	High	DMJ2303	DMJ3294	DMJ3300
X	0.15	0.30	8	2	250	310	Low	DMF2186	DMF3245	DMF3292
				3	325	425	Med	DM32283	DME3271	DME3279
				4	550	650	High	DMJ2304	DMJ3295	DMJ3301
KU	0.05	0.15	13	2	270	330	Low	DMF2187	DMF3286	DMF3293
				3	350	450	Med	DME2284	DME3272	DME3280
				4	500	680	High	DMJ2246	DMJ3296	DMJ3302
K	-	0.1	18	2	270	350	Low	DMF2837		
				3	375	550	Med	DME2838		
				4	600	700	High	DMJ2839		

## Beam-Lead (Split Pairs), N-Type, Low, Medium, High Drive

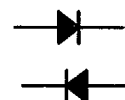

Freq. Band	C <sub>J</sub> 0V 1 MHz pF		R <sub>S</sub> 10 mA Ω	V <sub>B</sub> 10 μA Ω	V <sub>F</sub> 1 mA mV		Drive Level	Beam Lead	Epoxy	Hermetic	
	Min	Max			Max	Min		Min	Max	521-008	132-008
<b>S</b>	0.30	0.50	5	2	220	290	Low	DMF2196	DMF4040	DMF3070	
				3	300	400	Med	DME2199	DME3009	DME3019	
				4	500	600	High	DMJ2844	DMJ3095	DMJ3098	
<b>X</b>	0.15	0.30	8	2	250	310	Low	DMF2197	DMF5828	DMF3071	DMF4713
				3	325	425	Med	DME2841	DME3010	DME3020	DME3023
				4	550	650	High	DMJ2845	DMJ3096	DMJ3105	DMJ3106
<b>KU</b>	0.05	0.15	13	2	270	330	Low	DMF2198	DMF6023		DMF3062
				3	350	450	Med	DME2842	DME3011	DME3232	DME3024
				4	500	680	High	DMJ2846	DMJ3097	DMJ3234	DMJ3107
<b>K</b>	-	0.1	18	2	270	350	Low	DMF2840			
				3	375	550	Med	DME2843			
				4	600	700	High	DMJ2847			

## Beam-Lead (Ring Quad), N-Type, Low, Medium, High Drive

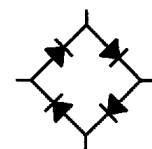

Freq. Band	C <sub>J</sub> 0V 1 MHz pF		R <sub>S</sub> 10 mA Ω	V <sub>B</sub> 10 μA Ω	V <sub>F</sub> 1 mA mV		Drive Level	Beam Lead	Epoxy				Hermetic	
	Min	Max			Max	Min		Min	Max	488-002	495-002	132-002	464-002	325-002
<b>S</b>	0.30	0.50	5	2	220	290	Low	DMF2829	DMF3954	DMF5847	DMF3915	DMF4059	DMF3244	
				3	300	400	Med	DME2857	DME3955	DME3038	DME3451	DME3044	DME3238	
				4	500	600	High	DMJ2502	DMJ3956	DMJ4007		DMJ6668	DMJ3237	
<b>X</b>	0.15	0.30	8	2	250	310	Low	DMF2011		DMF5829	DMF3918	DMF5080	DMF3074	
				3	325	425	Med	DME2858		DME4756		DME6557	DME4790	
				4	550	650	High	DMJ2990		DMJ6788		DMJ6669	DMJ3108	
<b>KU</b>	0.05	0.15	13	2	270	330	Low	DMF2012		DMF6395	DMF3431	DMF3916	DMF3075	
				3	350	450	Med	DME2859		DME3039	DME3437		DME3047	
				4	500	680	High	DMJ2667		DMJ3082	DMJ3443		DMJ3109	
<b>K</b>	-	0.1	18	2	270	350	Low	DMF2454			DMF3383			
				3	375	550	Med	DME2459			DME3384			
				4	600	700	High	DMJ2455			DMJ3385			

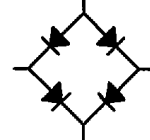

## Beam-Lead (Bridge Quad), N-Type, Low, Medium, High Drive

Freq. Band	C <sub>J</sub> 0V 1 MHz pF		R <sub>S</sub> 10 mA Ω	V <sub>B</sub> 10 μA Ω	V <sub>F</sub> 1mA mV		Drive Level	Beam Lead	Epoxy			Hermetic	
	Min	Max	Max	Min	Min	Max		488-004	495-004	132-004	464-004	325-004	364-004
S	0.30	0.50	5	2	220	290	Low	DMF2076	DMF3957	DMF5848	DMF3498	DMF3063	DMF3373
				3	300	400	Med	DME2029	DME3958	DME3040		DME3032	
				4	500	600	High	DMJ2312	DMJ3959	DMJ6575		DMJ3120	
X	0.15	0.30	8	2	250	310	Low	DMF2077		DMF6288		DMF4352	DMF3079
				3	325	425	Med	DME2850		DME4370		DME3033	DME3036
				4	550	650	High	DMJ2088		DMJ4313		DMJ3121	DMJ3122
KU	0.05	0.15	13	2	270	330	Low	DMF2078		DMF6298			DMF3080
				3	350	450	Med	DME2031		DME3041			DME3037
				4	500	680	High	DMJ2768		DMJ3083			DMJ3123
K	-	0.1	18	2	270	350	Low	DMF2848					
				3	375	550	Med	DME2851					
				4	600	700	High	DMJ2852					

## Beam-Lead (Star Quad), N-Type, Low, Medium, High Drive

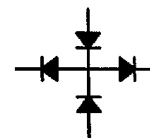

Freq. Band	C <sub>J</sub> 0V 1 MHz pF		R <sub>S</sub> 10 mA Ω	V <sub>B</sub> 10 μA Ω	V <sub>F</sub> 1mA mV		Drive Level	520-034	364-034
	Min	Max	Max	Min	Min	Max			
S	0.30	0.50	5	2	220	290	Low	DMF2137	DMF3251
				3	300	400	Med	DME2191	DME3254
				4	500	600	High	DMJ2193	DMJ3257
X	0.15	0.30	8	2	250	310	Low	DMF2138	DMF3252
				3	325	425	Med	DME2192	DME3255
				4	550	650	High	DMJ2194	DMJ3258
KU	0.05	0.15	13	2	270	330	Low	DMF2189	DMF3253
				3	350	450	Med	DME2178	DME3256
				4	500	680	High	DMJ2195	DMJ3259
K	-	0.1	18	2	270	350	Low	DMF2190	
				3	375	550	Med	DME2174	
				4	600	700	High	DMJ2180	

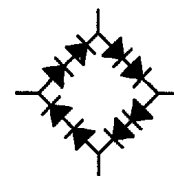

## Beam-Lead (Octo Quad Ring), N-Type, Low, Medium, High Drive

Freq. Band	C <sub>J</sub> 0V 1 MHz pF		R <sub>S</sub> 10 mA Ω	V <sub>B</sub> 10 μA Ω	V <sub>F</sub> 1 mA mV		Drive Level	Package Styles			
	Min	Max	Max	Min	Min	Max		132-020	495-020	325-020	364-020
<b>S</b>	0.30	0.50	5	2	220	290	Low	—	—	DMF3179	—
				3	300	400	High	—	DMJ3961	—	—
<b>X</b>	0.15	0.30	8	2	250	310	Low	DMF3242	—	—	DMF3972
				3	325	425	Med	DME4399	—	DME3346	DME3974
				4	550	650	High	DMJ4708	—	DMJ4394	DMJ3112
<b>KU</b>	0.05	0.15	13	2	270	330	Low	—	—	—	DMF3975
				3	350	450	Med	—	—	—	DME3978
				4	500	680	High	DMJ3091	—	—	DMJ3113

# RF GaAs MMIC Products in Metal Packages

## Numerical Index

Part Number	Page	Part Number	Page	Part Number	Page
AD004T2-00	2-44	AK006R2-01	2-30	AS006M1-01	2-8
AD004T2-11	2-44	AK006R2-10	2-30	AS006M1-10	2-8
AE002M2-29	2-74	AK006R2-00	2-28	AS006M2-00	2-16
AE002M4-05	2-42	AK402D4-11	2-64	AS006M2-01	2-22
AH002R2-11	2-26	AK402D4-31	2-68	AS006M2-10	2-22
AK002D2-11	2-70	AN002M2-29	2-72	AS006R1-00	2-4
AK002D4-11	2-62	AN002M4-31	2-38	AS006R2-00	2-16
AK002D4-31	2-66	AN002M4-05	2-40	AS006R2-01	2-20
AK002M4-00	2-36	AS002M4-00	2-34	AS006R2-10	2-20
AK002M4-31	2-38	AS004L1-08	2-6	AS406M2-01	2-24
AK004L1-11	2-12	AS004L1-11	2-6	AS406R2-01	2-24
AK004M1-11	2-14	AS004L2-11	2-18	AT001D3-11	2-60
AK004M2-11	2-32	AS004M1-08	2-8	AT001D4-31	2-56
AK004R2-11	2-30	AS004M1-11	2-8	AT001D6-31	2-58
AK006L1-00	2-10	AS004M2-08	2-22	AT002D8-31	2-54
AK006L1-01	2-12	AS004M2-11	2-22	AT002N5-00	2-49
AK006L1-10	2-12	AS004R2-08	2-20	AT002N5-01	2-49
AK006M1-00	2-10	AS004R2-11	2-20	AT002N5-10	2-49
AK006M1-01	2-14	AS006L1-00	2-4	AT002N5-11	2-49
AK006M1-10	2-14	AS006L1-01	2-6	AT002S3-11	2-52
AK006M2-01	2-32	AS006L1-10	2-6	AT004N3-11	2-46
AK006M2-10	2-32	AS006L2-00	2-18	AT006N3-00	2-46
AK006M2-00	2-28	AS006L2-01	2-18	AT006N3-10	2-46
AK006R1-00	2-10	AS006M1-00	2-4	AT006N3-01	2-46





## Стандарт Электрон Связь

Мы молодая и активно развивающаяся компания в области поставок электронных компонентов. Мы поставляем электронные компоненты отечественного и импортного производства напрямую от производителей и с крупнейших складов мира.

Благодаря сотрудничеству с мировыми поставщиками мы осуществляем комплексные и плановые поставки широчайшего спектра электронных компонентов.

Собственная эффективная логистика и склад в обеспечивает надежную поставку продукции в точно указанные сроки по всей России.

Мы осуществляем техническую поддержку нашим клиентам и предпродажную проверку качества продукции. На все поставляемые продукты мы предоставляем гарантию .

Осуществляем поставки продукции под контролем ВП МО РФ на предприятия военно-промышленного комплекса России , а также работаем в рамках 275 ФЗ с открытием отдельных счетов в уполномоченном банке. Система менеджмента качества компании соответствует требованиям ГОСТ ISO 9001.

Минимальные сроки поставки, гибкие цены, неограниченный ассортимент и индивидуальный подход к клиентам являются основой для выстраивания долгосрочного и эффективного сотрудничества с предприятиями радиоэлектронной промышленности, предприятиями ВПК и научно-исследовательскими институтами России.

С нами вы становитесь еще успешнее!

### Наши контакты:

**Телефон:** +7 812 627 14 35

**Электронная почта:** [sales@st-electron.ru](mailto:sales@st-electron.ru)

**Адрес:** 198099, Санкт-Петербург,  
Промышленная ул, дом № 19, литера Н,  
помещение 100-Н Офис 331