

High Isolation SP4T SWITCH

■ GENERAL DESCRIPTION

The NJG1699MD7 is a GaAs high isolation SP4T switch MMIC. It features low insertion loss and very high isolation. It has integrated DC blocking capacitor at PC port.

The ESD protection circuits are integrated in the IC to achieve high ESD tolerance.

The ultra-small and ultra-thin EQFN14-D7 package is adopted.

■ PACKAGE OUTLINE

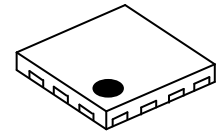

NJG1699MD7

■ APPLICATIONS

Suitable for multi-mode 2G/3G and LTE application receive system Rx signal switching

■ FEATURES

- Low operation voltage $V_{DD}=+2.7V$ typ.
- Low control voltage $V_{CTL(H)}=+1.8V$ typ.
- High isolation
 - 50dB typ. @f=1.0GHz, $P_{IN}=0dBm$
 - 48dB typ. @f=2.0GHz, $P_{IN}=0dBm$
 - 43dB typ. @f=2.7GHz, $P_{IN}=0dBm$
- Low insertion loss
 - 0.55dB typ. @f=1.0GHz, $P_{IN}=0dBm$
 - 0.55dB typ. @f=2.0GHz, $P_{IN}=0dBm$
 - 0.65dB typ. @f=2.7GHz, $P_{IN}=0dBm$
- Small package EQFN14-D7 (Package size: 1.6x1.6x0.397mm typ.)
- RoHS compliant and Halogen Free
- MSL 1

■ PIN CONFIGURATION

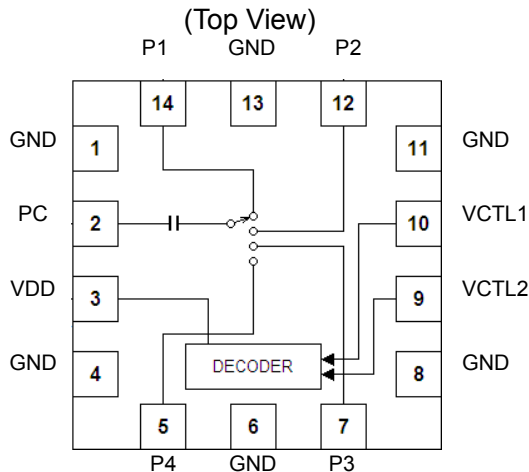

Pin connection

- | | |
|--------|-----------|
| 1. GND | 8. GND |
| 2. PC | 9. VCTL2 |
| 3. VDD | 10. VCTL1 |
| 4. GND | 11. GND |
| 5. P4 | 12. P2 |
| 6. GND | 13. GND |
| 7. P3 | 14. P1 |

Exposed PAD: GND

■ TRUTH TABLE

“H”= $V_{CTL(H)}$, “L”= $V_{CTL(L)}$

ON PATH	VCTL1	VCTL2
PC-P1	H	L
PC-P2	L	L
PC-P3	L	H
PC-P4	H	H

NOTE: Please note that any information on this catalog will be subject to change.

NJG1699MD7

■ ABSOLUTE MAXIMUM RATINGS

($T_a=+25^{\circ}\text{C}$, $Z_s=Z_i=50\Omega$)

PARAMETER	SYMBOL	CONDITIONS	RATINGS	UNITS
RF Input Power	P_{IN}	$V_{DD}=2.7\text{V}$	28	dBm
Supply Voltage	V_{DD}	VDD terminal	5.0	V
Control Voltage	V_{CTL}	VCTL1, VCTL2 terminal	5.0	V
Power Dissipation	P_D	Four-layer FR4 PCB with through-hole (76.2x114.3mm), $T_j=150^{\circ}\text{C}$	1300	mW
Operating Temp.	T_{opr}		-40~+90	$^{\circ}\text{C}$
Storage Temp.	T_{stg}		-55~+150	$^{\circ}\text{C}$

■ ELECTRICAL CHARACTERISTICS

(General conditions: $T_a=+25^{\circ}\text{C}$, $Z_s=Z_i=50\Omega$, $V_{DD}=2.7\text{V}$, $V_{CTL(L)}=0\text{V}$, $V_{CTL(H)}=1.8\text{V}$, with application circuit)

PARAMETERS	SYMBOL	CONDITIONS	MIN	TYP	MAX	UNITS
Supply Voltage	V_{DD}	VDD terminal	1.5	2.7	4.5	V
Operating Current	I_{DD}		-	20	40	μA
Control Voltage (LOW)	$V_{CTL(L)}$	VCTL1, VCTL2 terminal	0	0	0.45	V
Control Voltage (HIGH)	$V_{CTL(H)}$	VCTL1, VCTL2 terminal	1.35	1.8	4.5	V
Control Current	I_{CTL}	$V_{CTL(H)}=1.8\text{V}$	-	5	10	μA
Insertion Loss 1	LOSS1	$f=1.0\text{GHz}$, $P_{IN}=0\text{dBm}$	-	0.55	0.75	dB
Insertion Loss 2	LOSS2	$f=2.0\text{GHz}$, $P_{IN}=0\text{dBm}$	-	0.55	0.75	dB
Insertion Loss 3	LOSS3	$f=2.7\text{GHz}$, $P_{IN}=0\text{dBm}$	-	0.60	0.80	dB
Isolation 1	ISL1	PC-P1, P2, P3, P4 $f=1.0\text{GHz}$, $P_{IN}=0\text{dBm}$	45	50	-	dB
Isolation 2	ISL2	PC-P1, P2, P3, P4 $f=2.0\text{GHz}$, $P_{IN}=0\text{dBm}$	45	48	-	dB
Isolation 3	ISL3	PC-P1, P2, P3, P4 $f=2.7\text{GHz}$, $P_{IN}=0\text{dBm}$	40	43	-	dB
Input power at 0.2dB Compression Point	$P_{-0.2\text{dB}}$	$f=2.0\text{GHz}$	18	22	-	dBm
VSWR	VSWR	$f=2.0\text{GHz}$, On port	-	1.3	1.5	-
Switching time	T_{SW}	50% V_{CTL} to 10/90% RF	-	2	5	μs

■ TERMINAL INFORMATION

No.	SYMBOL	DESCRIPTION
1	GND	Ground terminal. Please connect this terminal with ground plane as close as possible for excellent RF performance.
2	PC	RF input/output port. No DC blocking capacitor is required for this port because of internal capacitor.
3	VDD	Positive voltage supply terminal. The positive voltage (+1.5~+4.5V) has to be supplied. Please connect a bypass capacitor with GND terminal for excellent RF performance.
4	GND	Ground terminal. Please connect this terminal with ground plane as close as possible for excellent RF performance.
5	P4	RF input / output port. External capacitor is required to block the DC bias voltage of internal circuit.
6	GND	Ground terminal. Please connect this terminal with ground plane as close as possible for excellent RF performance.
7	P3	RF input / output port. External capacitor is required to block the DC bias voltage of internal circuit.
8	GND	Ground terminal. Please connect this terminal with ground plane as close as possible for excellent RF performance.
9	VCTL2	Control signal input terminal. This terminal is set to High-Level (+1.35~+4.5V) or Low-Level (0~+0.45V).
10	VCTL1	Control signal input terminal. This terminal is set to High-Level (+1.35~+4.5V) or Low-Level (0~+0.45V).
11	GND	Ground terminal. Please connect this terminal with ground plane as close as possible for excellent RF performance.
12	P2	RF input / output port. External capacitor is required to block the DC bias voltage of internal circuit.
13	GND	Ground terminal. Please connect this terminal with ground plane as close as possible for excellent RF performance.
14	P1	RF input / output port. External capacitor is required to block the DC bias voltage of internal circuit.
Exposed Pad	GND	Ground terminal.

NJG1699MD7

■ ELECTRICAL CHARACTERISTICS (With Application circuit, Loss of external circuit are excluded)

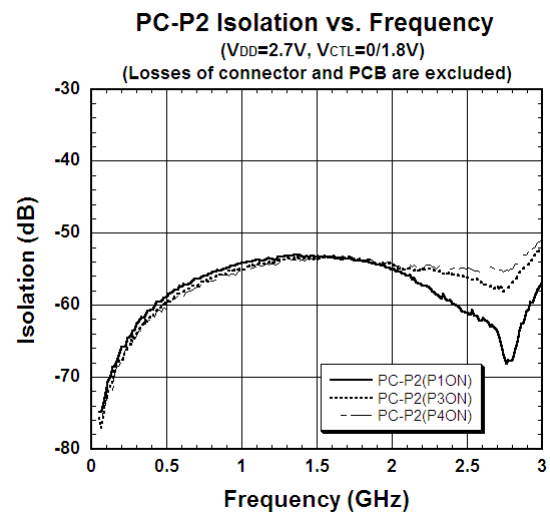
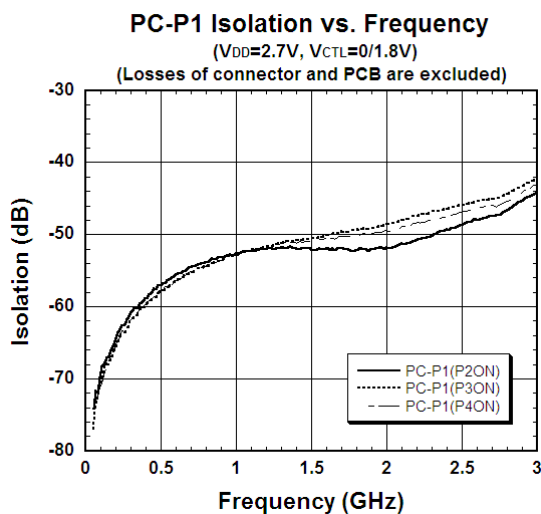
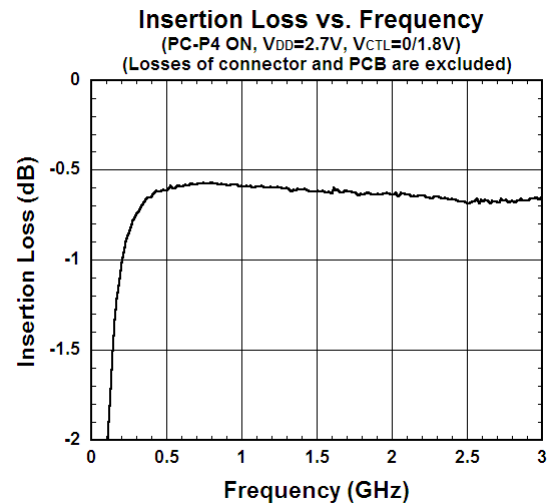
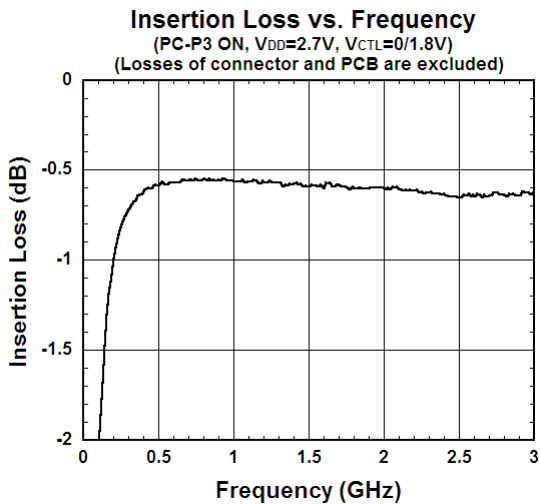
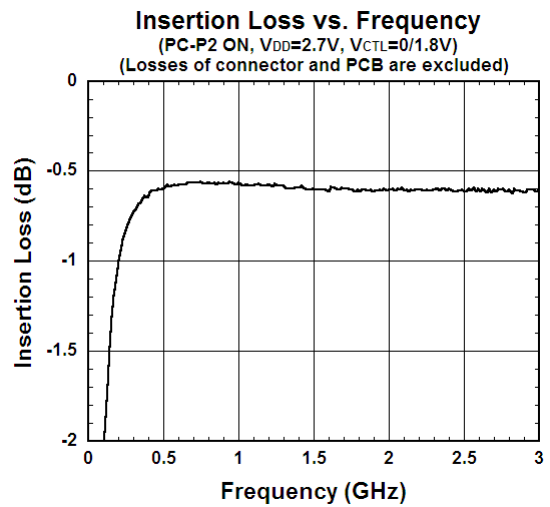
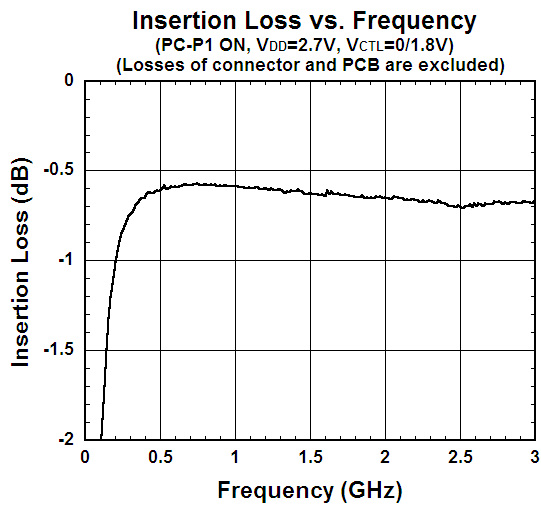

■ ELECTRICAL CHARACTERISTICS (With Application circuit, Loss of external circuit are excluded)

PC-P3 Isolation vs. Frequency

($V_{DD}=2.7V$, $V_{CTL}=0/1.8V$)

(Losses of connector and PCB are excluded)

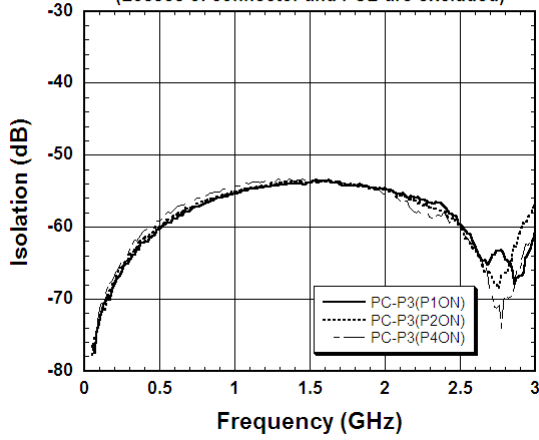

PC-P4 Isolation vs. Frequency

($V_{DD}=2.7V$, $V_{CTL}=0/1.8V$)

(Losses of connector and PCB are excluded)

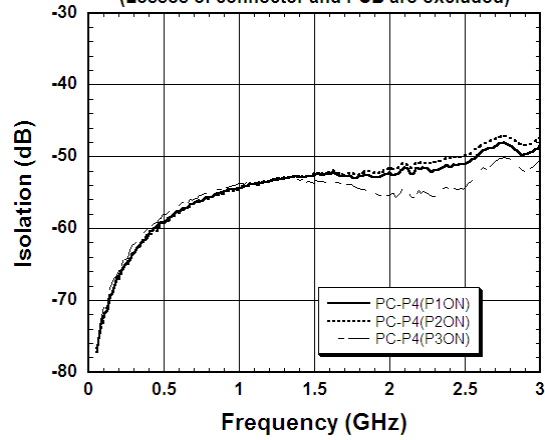

VSWR vs. Frequency

(PC-P1 ON, $V_{DD}=2.7V$, $V_{CTL}=0/1.8V$)

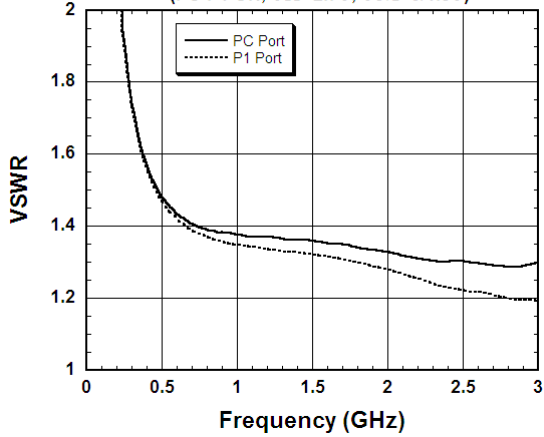

VSWR vs. Frequency

(PC-P2 ON, $V_{DD}=2.7V$, $V_{CTL}=0/1.8V$)

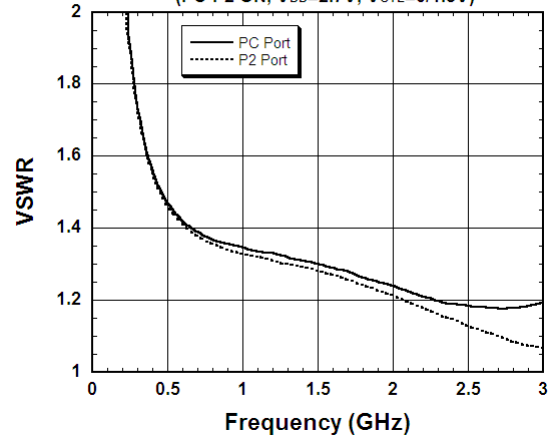

VSWR vs. Frequency

(PC-P3 ON, $V_{DD}=2.7V$, $V_{CTL}=0/1.8V$)

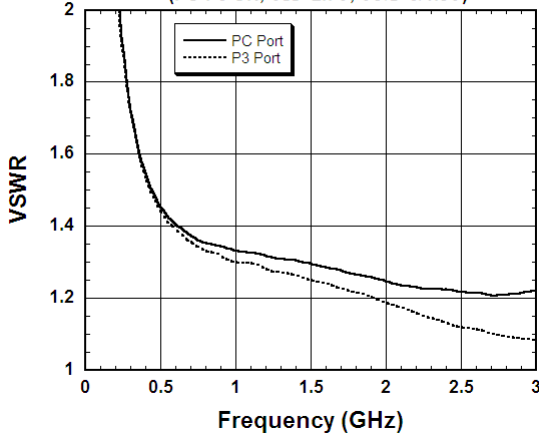

VSWR vs. Frequency

(PC-P4 ON, $V_{DD}=2.7V$, $V_{CTL}=0/1.8V$)

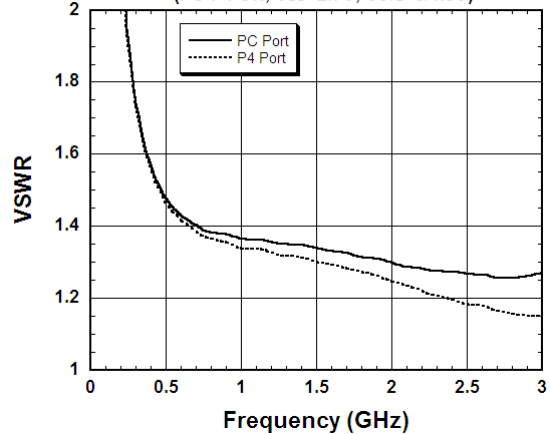

NJG1699MD7

■ ELECTRICAL CHARACTERISTICS (With Application circuit, Loss of external circuit are excluded)

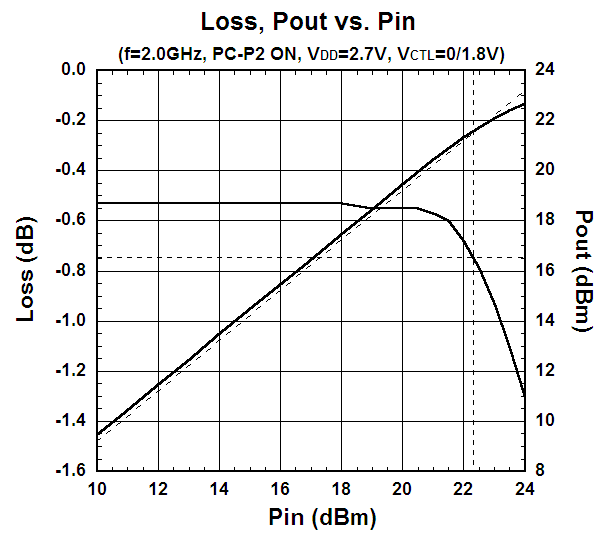
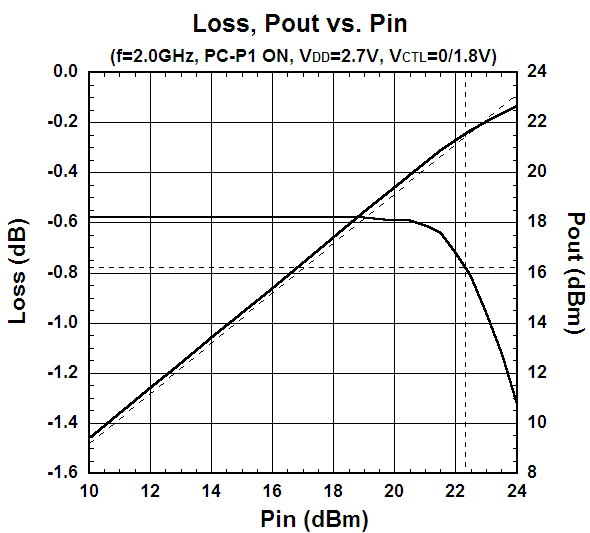
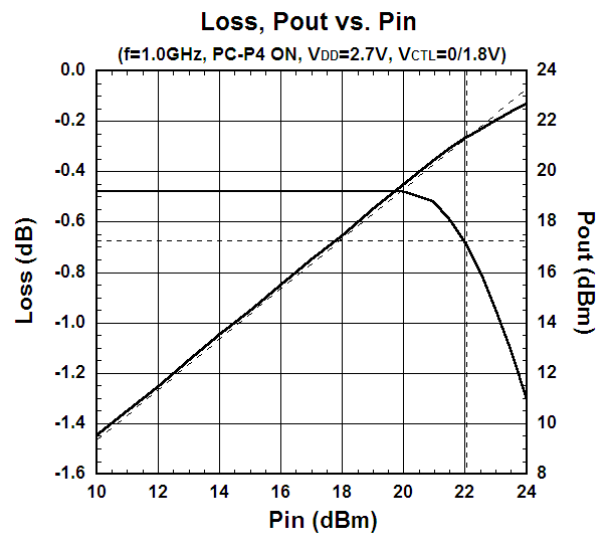
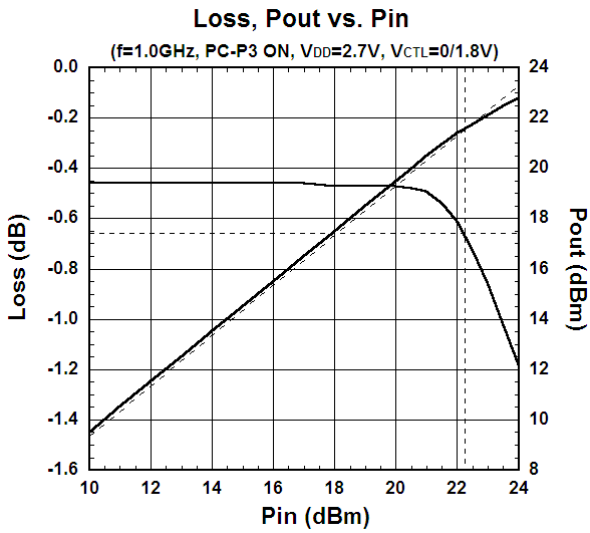
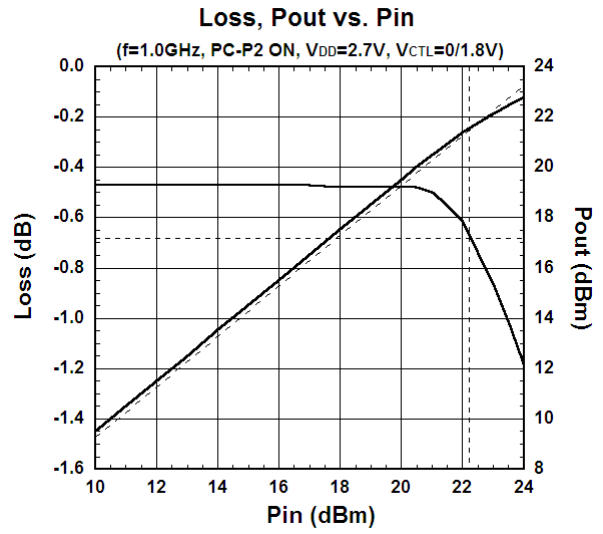
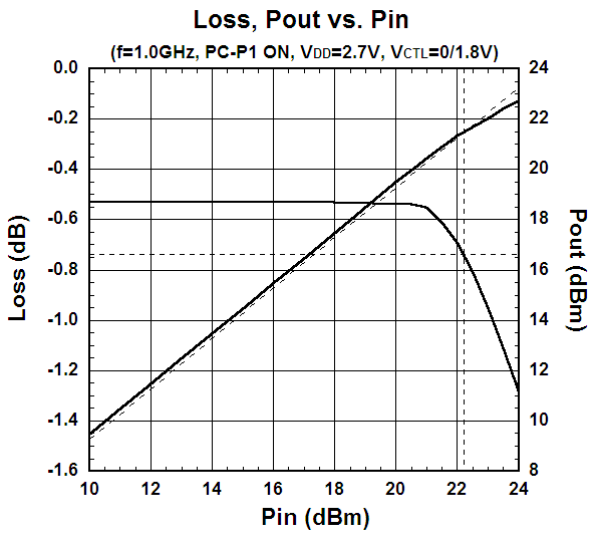

■ ELECTRICAL CHARACTERISTICS (With Application circuit, Loss of external circuit are excluded)

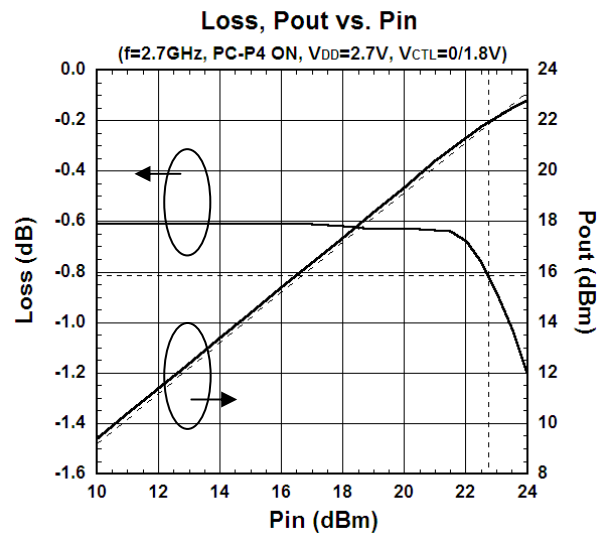
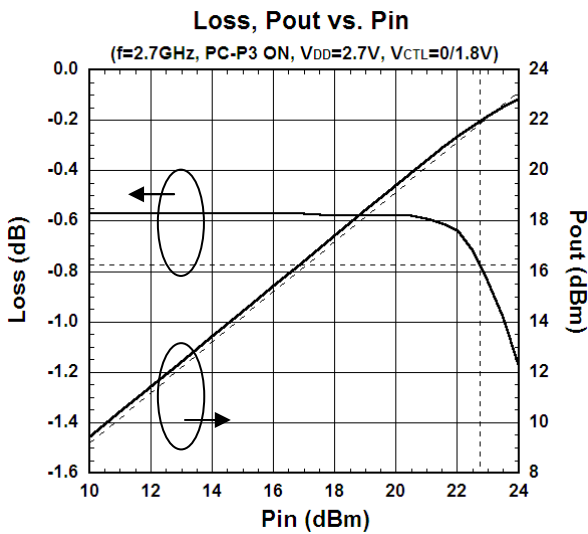
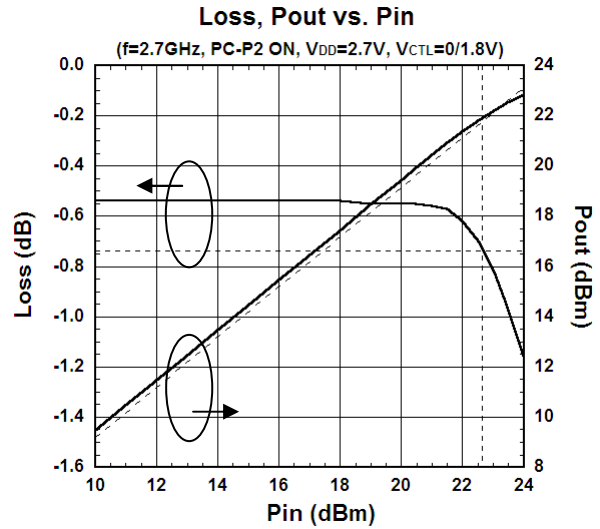
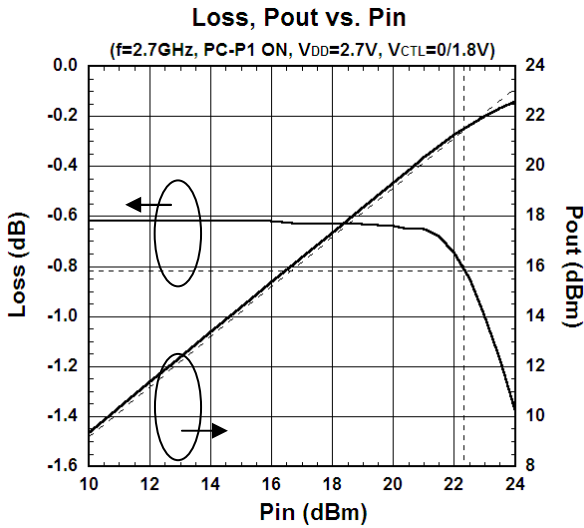
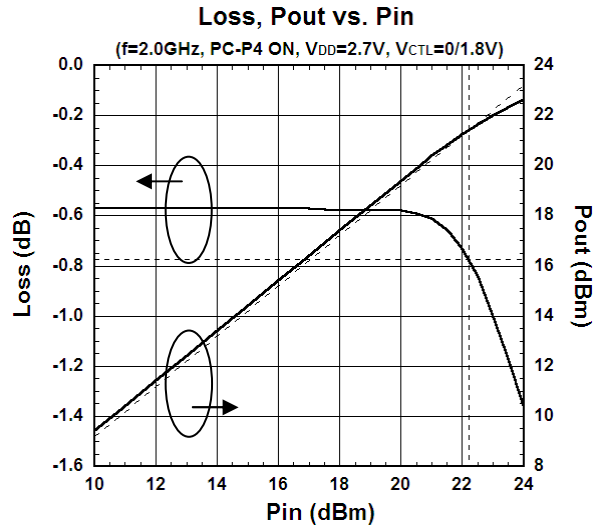
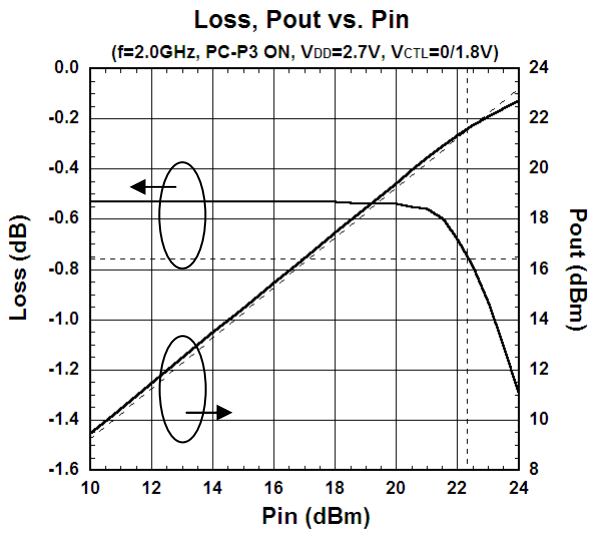

NJG1699MD7

■ ELECTRICAL CHARACTERISTICS (With Application circuit, Loss of external circuit are excluded)

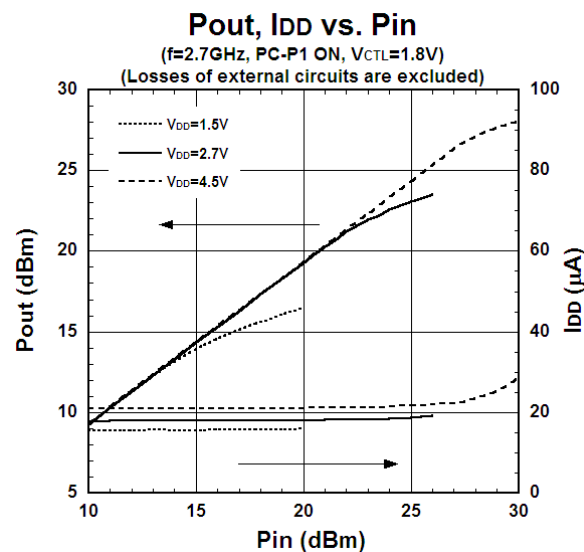
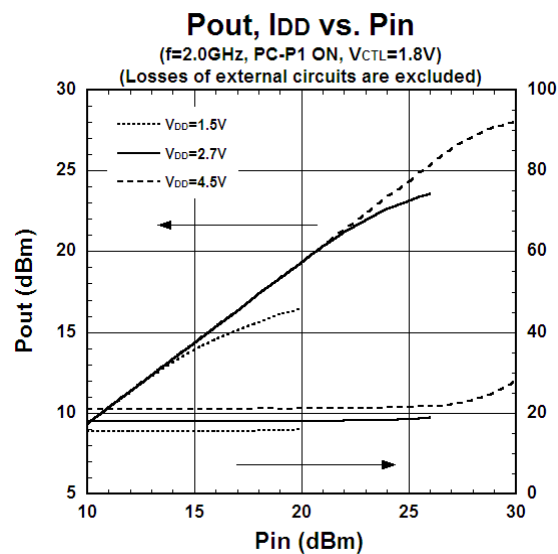
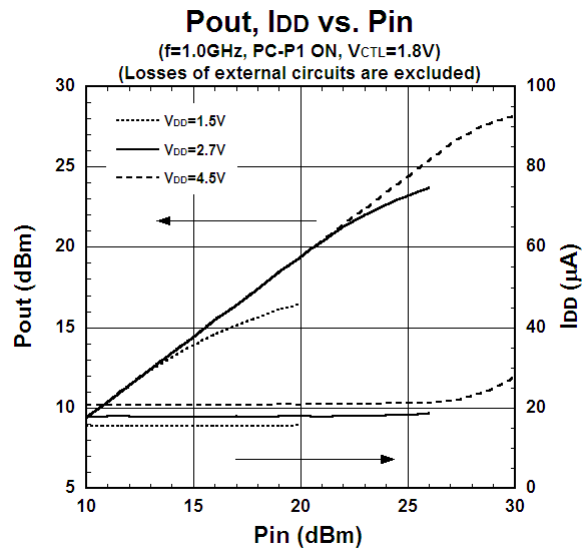
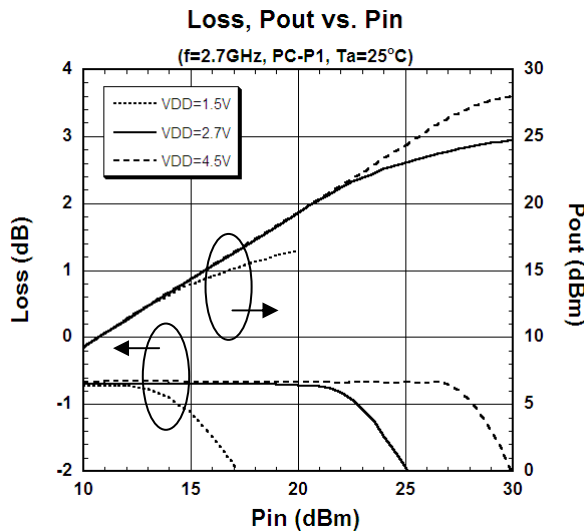
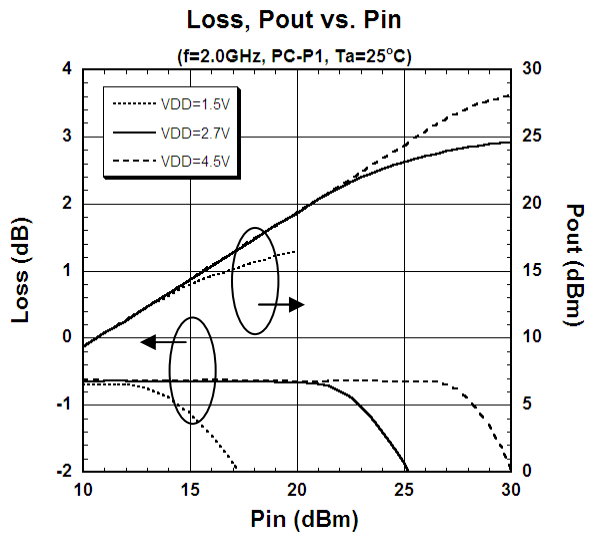
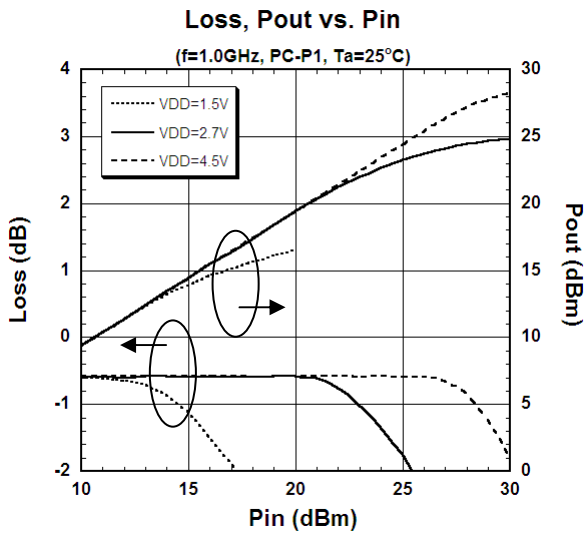

■ ELECTRICAL CHARACTERISTICS (With Application circuit, Loss of external circuit are excluded)

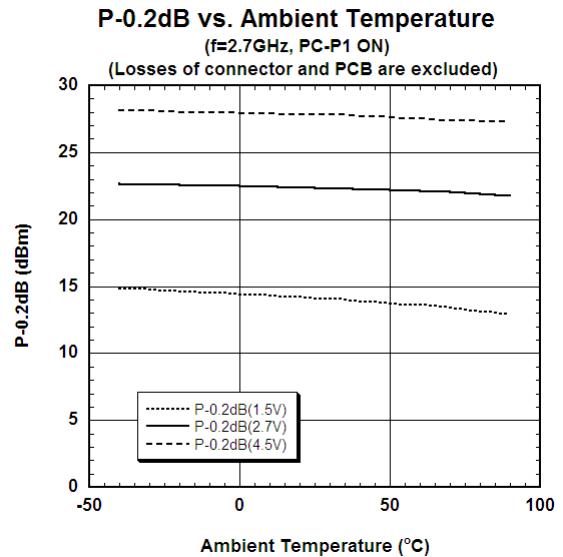
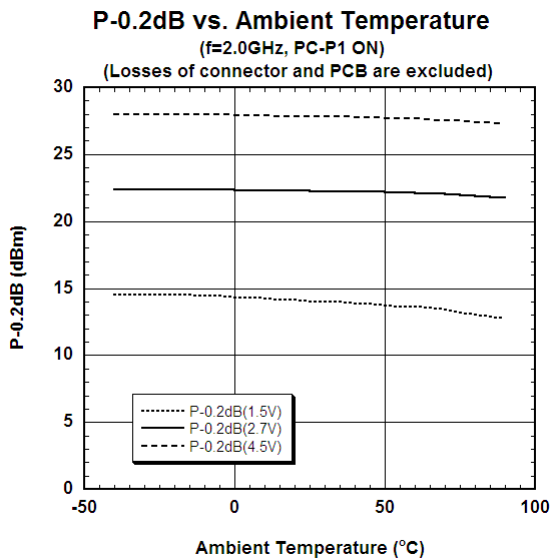
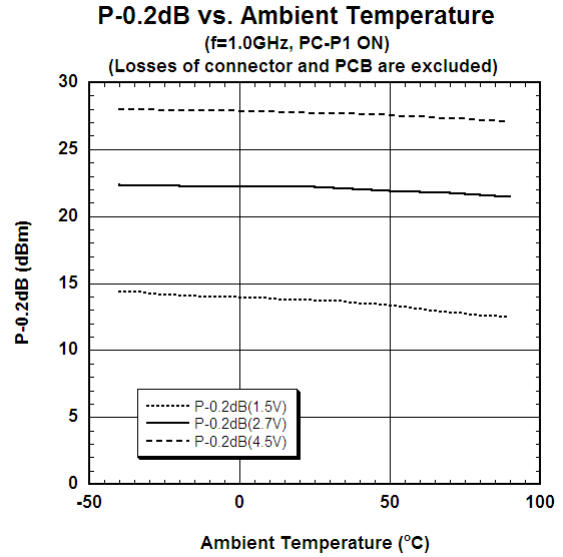
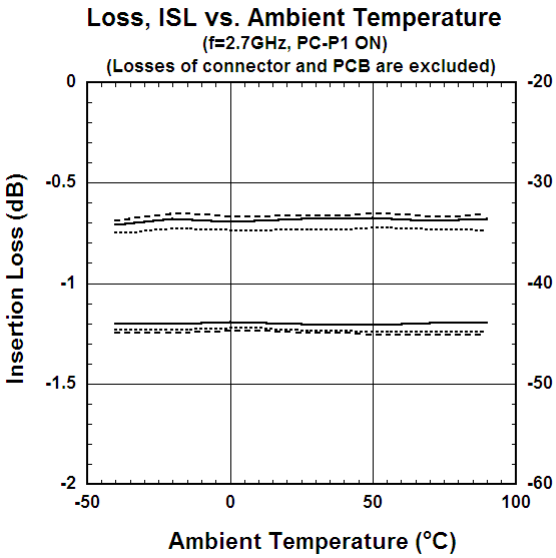
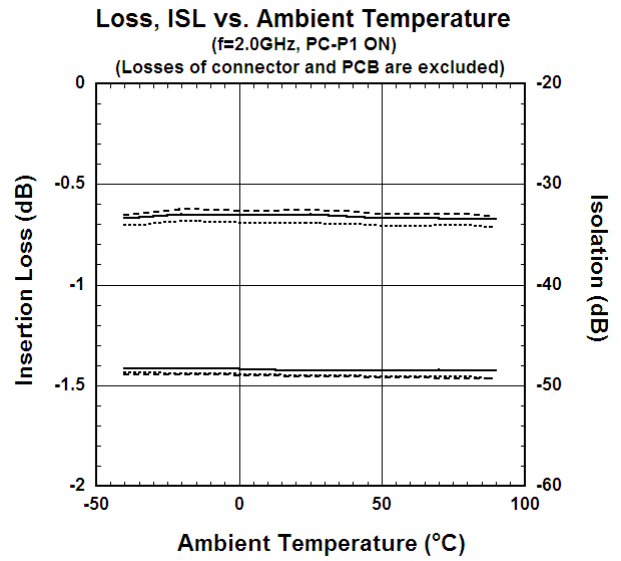
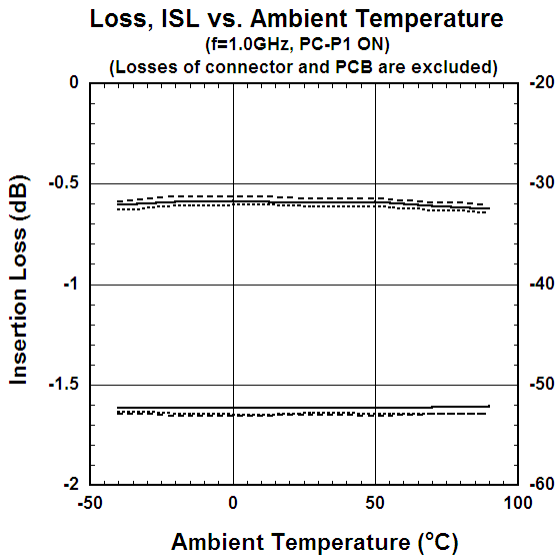

NJG1699MD7

■ ELECTRICAL CHARACTERISTICS (With Application circuit, Loss of external circuit are excluded)

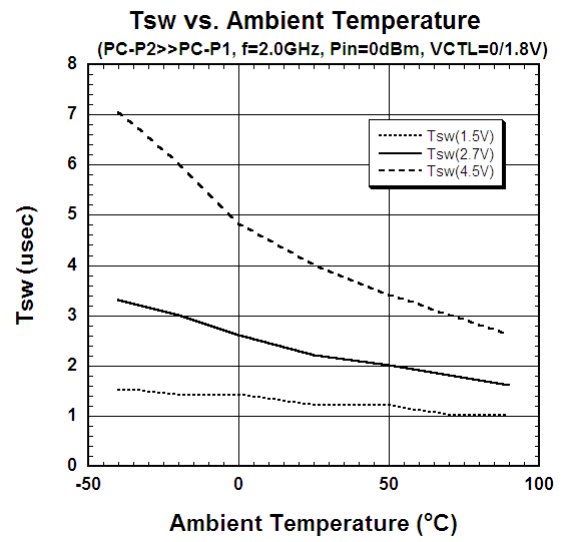
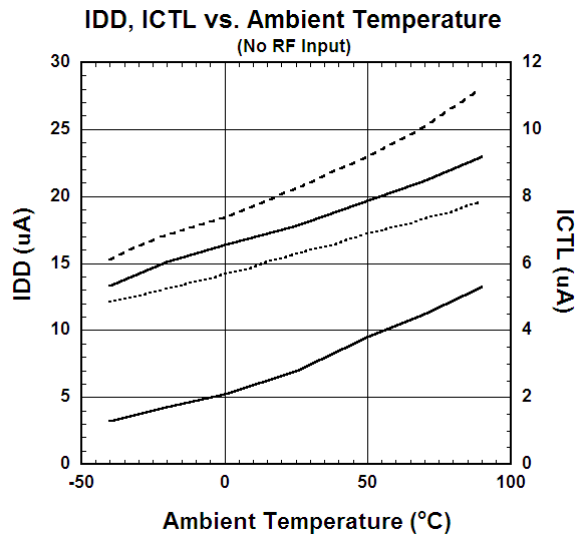

APPLICATION CIRCUIT

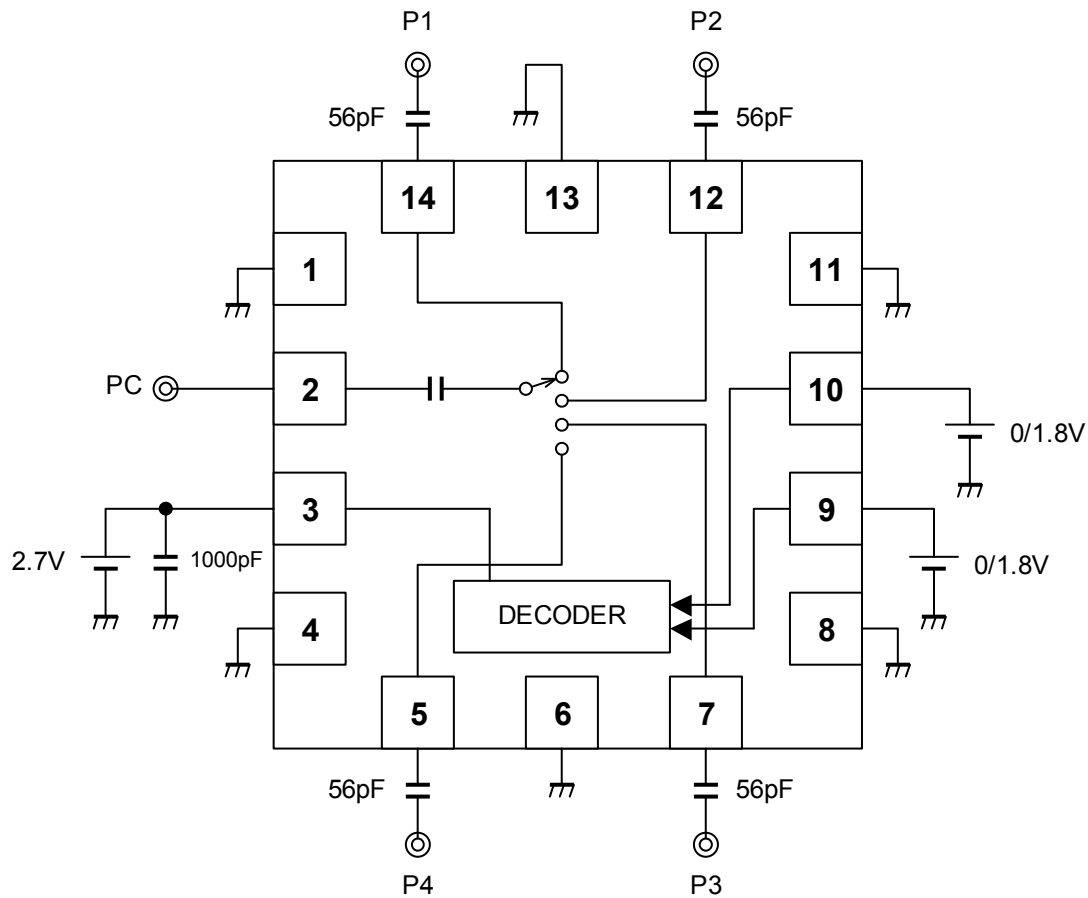

No external DC blocking capacitor at PC terminal is required because of the internal capacitor in IC.

PARTS LIST

Part ID	Value	Notes
C1~C4	56pF	MURATA (GRM15)
C5	1000pF	MURATA (GRM15)

NJG1699MD7

APPLIED CIRCUIT BOARD EXAMPLES (TOP VIEW)

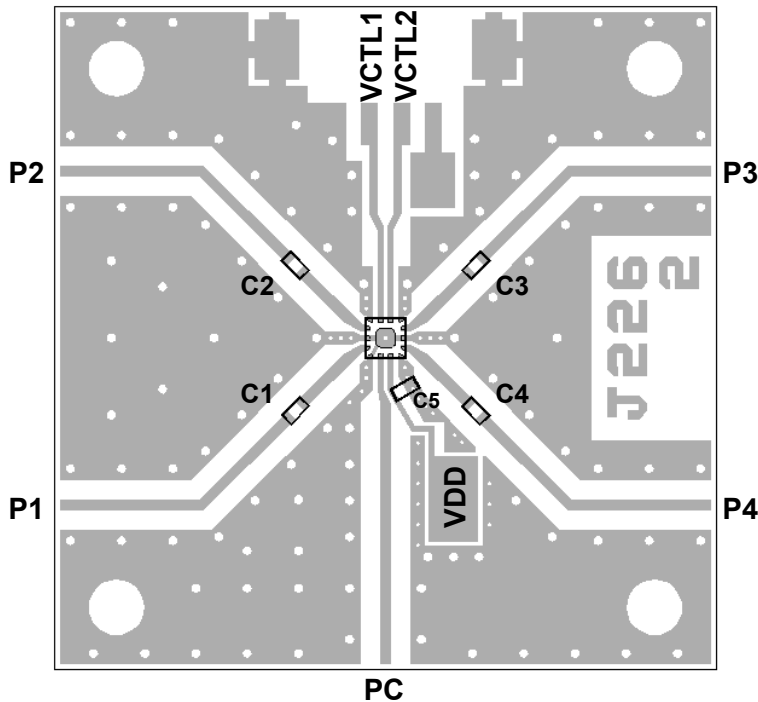





PCB: FR-4, t=0.2mm
 Capacitor Size: 1005 (1.0 x 0.5 mm)
 Strip Line Width: 0.4mm
 PCB Size: 25.8 x 25.8mm
 Through Hole Diameter: 0.2mm

Losses of PCB, capacitors and connectors

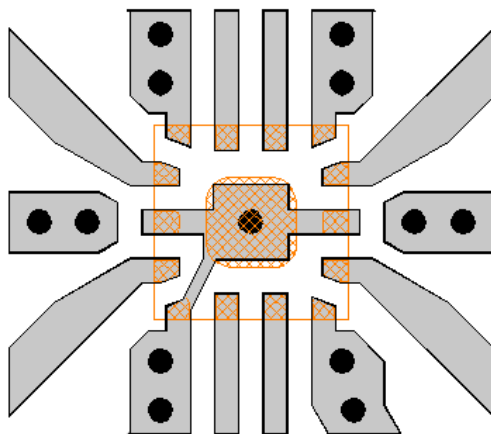
Paths	Frequency (GHz)	Loss (dB)
PC-P1	1.0	0.31
PC-P2	2.0	0.44
PC-P3	2.7	0.55
PC-P4		

<PCB LAYOUT GUIDELINE>





-  PCB
-  PKG Terminal
-  PKG Outline
-  GND Via Hole
Diameter $\phi=0.2\text{mm}$

PRECAUTIONS

- [1] The DC current at RF ports must be equal to zero, which can be achieved with DC blocking capacitors (C1~C4).
 (However, in case there is no possibility that DC current flows, the DC blocking capacitors are unnecessary, i.e. the RF signals are fed by SAW filters that block DC current by nature, etc.)
- [2] To reduce stripline influence on RF characteristics, please locate the bypass capacitor (C5) close to VDD terminal.
- [3] For good isolation, the GND terminals must be connected to the PCB ground plane of substrate, and the through-holes connecting the backside ground plane should be placed near by the pin connection.

RECOMMENDED FOOTPRINT PATTERN (EQFN14-D7 PACKAGE Reference)

-  :Land
-  :Mask (Open area) *Metal mask thickness : 100um
-  :Resist(Open area)

PKG: 1.6mm x 1.6mm
Pin pitch: 0.4mm

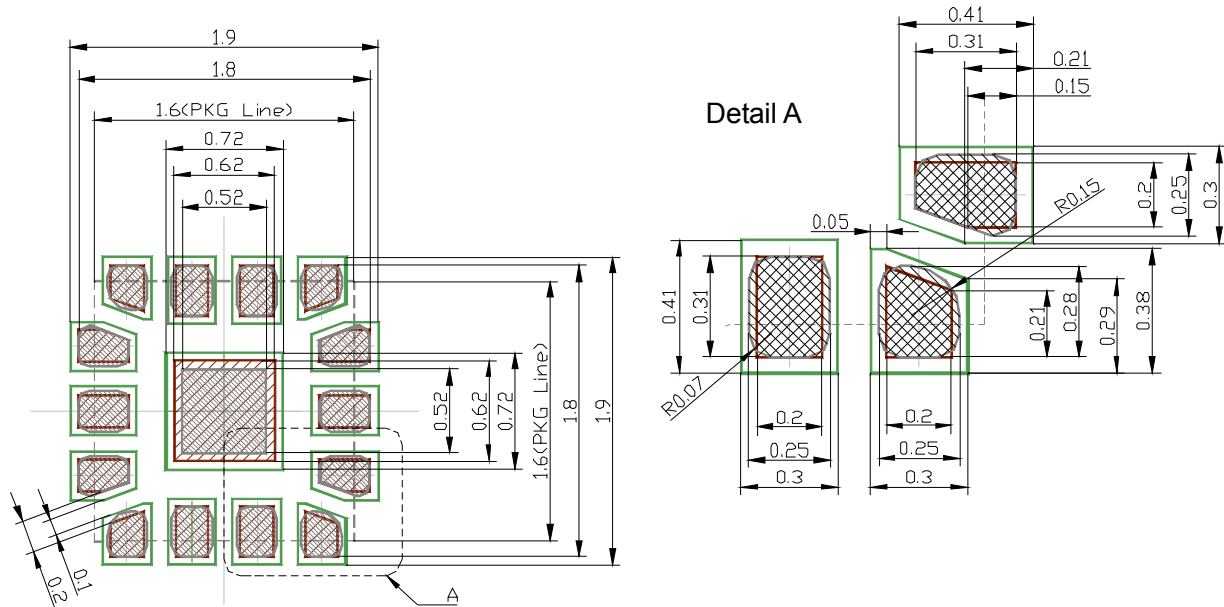

NJG1699MD7

PACKAGE OUTLINE (EQFN14-D7)

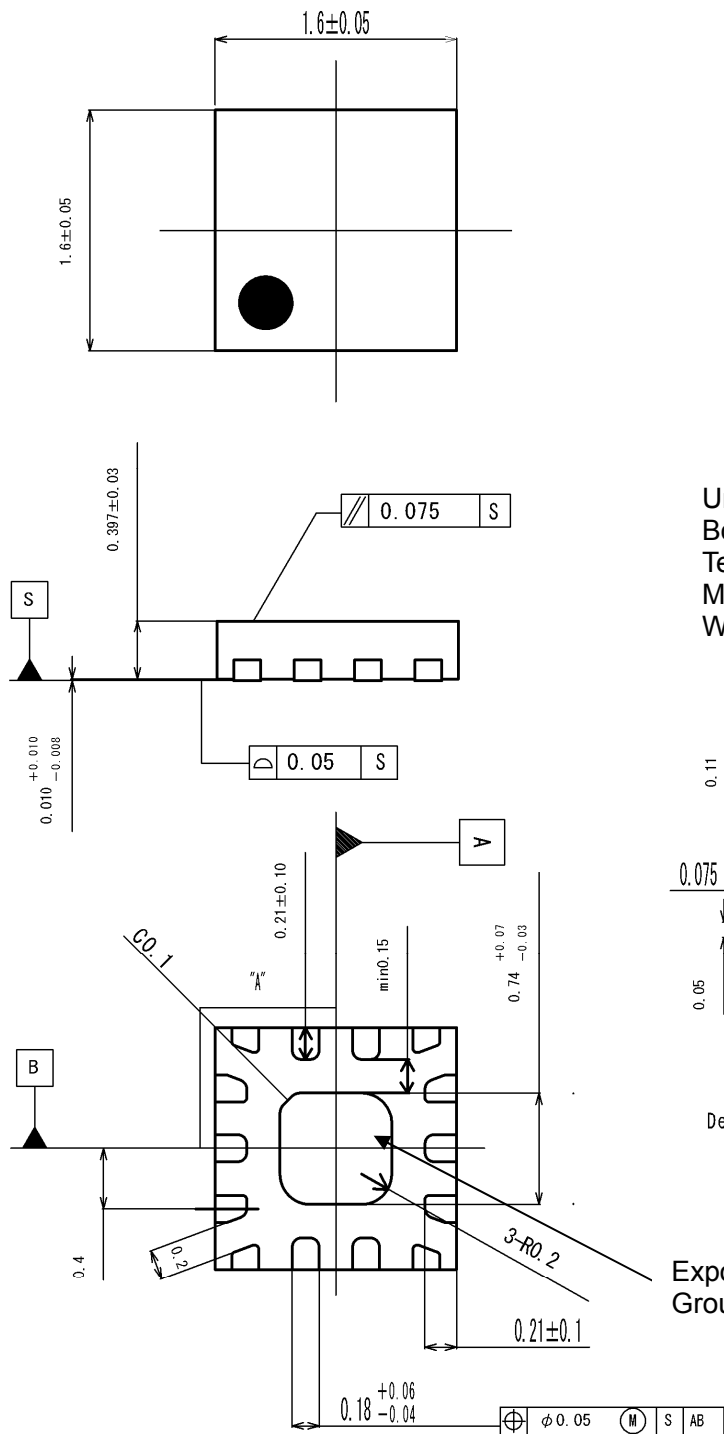

Units : mm
 Board : Cu
 Terminal treat : SnBi
 Molding material : Epoxy resin
 Weight : 3.4mg

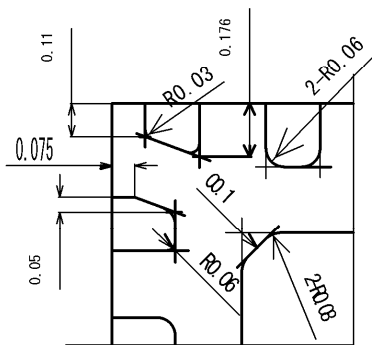

Details of "A" part (× 2)

Exposed PAD
 Ground connection is required.

Cautions on using this product

- This product contains Gallium-Arsenide (GaAs) which is a harmful material.
- Do NOT eat or put into mouth.
 - Do NOT dispose in fire or break up this product.
 - Do NOT chemically make gas or powder with this product.
 - To waste this product, please obey the relating law of your country.

[CAUTION]

The specifications on this databook are only given for information, without any guarantee as regards either mistakes or omissions. The application circuits in this databook are described only to show representative usages of the product and not intended for the guarantee or permission of any right including the industrial rights.

This product may be damaged with electric static discharge (ESD) or spike voltage. Please handle with care to avoid these damages.

Mouser Electronics

Authorized Distributor

Click to View Pricing, Inventory, Delivery & Lifecycle Information:

[NJR:](#)

[NJG1699MD7](#) [NJG1699MD7-TE1](#)



Стандарт Электрон Связь

Мы молодая и активно развивающаяся компания в области поставок электронных компонентов. Мы поставляем электронные компоненты отечественного и импортного производства напрямую от производителей и с крупнейших складов мира.

Благодаря сотрудничеству с мировыми поставщиками мы осуществляем комплексные и плановые поставки широчайшего спектра электронных компонентов.

Собственная эффективная логистика и склад в обеспечивает надежную поставку продукции в точно указанные сроки по всей России.

Мы осуществляем техническую поддержку нашим клиентам и предпродажную проверку качества продукции. На все поставляемые продукты мы предоставляем гарантию .

Осуществляем поставки продукции под контролем ВП МО РФ на предприятия военно-промышленного комплекса России , а также работаем в рамках 275 ФЗ с открытием отдельных счетов в уполномоченном банке. Система менеджмента качества компании соответствует требованиям ГОСТ ISO 9001.

Минимальные сроки поставки, гибкие цены, неограниченный ассортимент и индивидуальный подход к клиентам являются основой для выстраивания долгосрочного и эффективного сотрудничества с предприятиями радиоэлектронной промышленности, предприятиями ВПК и научно-исследовательскими институтами России.

С нами вы становитесь еще успешнее!

Наши контакты:

Телефон: +7 812 627 14 35

Электронная почта: sales@st-electron.ru

Адрес: 198099, Санкт-Петербург,
Промышленная ул, дом № 19, литера Н,
помещение 100-Н Офис 331