

Low  $V_{CE(sat)}$  IGBT with Diode  
High speed IGBT with Diode

IXGH 10 N100U1  
IXGH 10 N100AU1

$V_{CES}$	$I_{C25}$	$V_{CE(sat)}$
1000 V	20 A	3.5 V
1000 V	20 A	4.0 V

## Combi Packs

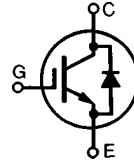

Symbol	Test Conditions	Maximum Ratings	
$V_{CES}$	$T_J = 25^\circ\text{C}$ to $150^\circ\text{C}$	1000	V
$V_{CGR}$	$T_J = 25^\circ\text{C}$ to $150^\circ\text{C}$ ; $R_{GE} = 1\text{ M}\Omega$	1000	V
$V_{GES}$	Continuous	$\pm 20$	V
$V_{GEM}$	Transient	$\pm 30$	V
$I_{C25}$	$T_C = 25^\circ\text{C}$	20	A
$I_{C90}$	$T_C = 90^\circ\text{C}$	10	A
$I_{CM}$	$T_C = 25^\circ\text{C}$ , 1 ms	40	A
<b>SSOA</b> <b>(RBSOA)</b>	$V_{GE} = 15\text{ V}$ , $T_{VJ} = 125^\circ\text{C}$ , $R_G = 150\ \Omega$ Clamped inductive load, $L = 300\ \mu\text{H}$	$I_{CM} = 20$ @ $0.8\ V_{CES}$	A
$P_C$	$T_C = 25^\circ\text{C}$	100	W
$T_J$		-55 ... +150	$^\circ\text{C}$
$T_{JM}$		150	$^\circ\text{C}$
$T_{stg}$		-55 ... +150	$^\circ\text{C}$
$M_d$	Mounting torque (M3)	1.13/10	Nm/lb.in.
<b>Weight</b>		6	g
Maximum lead temperature for soldering 1.6 mm (0.062 in.) from case for 10 s		300	$^\circ\text{C}$

TO-247 AD

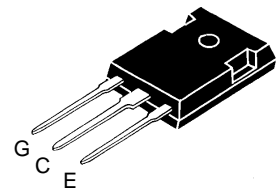

G = Gate, C = Collector,  
E = Emitter, TAB = Collector

### Features

- International standard package JEDEC TO-247 AD
- IGBT and anti-parallel FRED in one package
- 2nd generation HDMOS™ process
- Low  $V_{CE(sat)}$ 
  - for low on-state conduction losses
- MOS Gate turn-on
  - drive simplicity
- Fast Recovery Epitaxial Diode (FRED)
  - soft recovery with low  $I_{RM}$

### Applications

- AC motor speed control
- DC servo and robot drives
- DC choppers
- Uninterruptible power supplies (UPS)
- Switch-mode and resonant-mode power supplies

### Advantages

- Space savings (two devices in one package)
- Easy to mount with 1 screw (isolated mounting screw hole)
- Reduces assembly time and cost

Symbol	Test Conditions	Characteristic Values ( $T_J = 25^\circ\text{C}$ , unless otherwise specified)		
		min.	typ.	max.
$BV_{CES}$	$I_C = 4\text{ mA}$ , $V_{GE} = 0\text{ V}$	1000		V
$V_{GE(th)}$	$I_C = 500\ \mu\text{A}$ , $V_{CE} = V_{GE}$	2.5		5.5 V
$I_{CES}$	$V_{CE} = 0.8 \cdot V_{CES}$ $V_{GE} = 0\text{ V}$			400 $\mu\text{A}$ 5 mA
$I_{GES}$	$V_{CE} = 0\text{ V}$ , $V_{GE} = \pm 20\text{ V}$			$\pm 100\text{ nA}$
$V_{CE(sat)}$	$I_C = I_{C90}$ , $V_{GE} = 15\text{ V}$			3.5 V 4.0 V
				10N100U1 10N100AU1

Symbol	Test Conditions	Characteristic Values ( $T_J = 25^\circ\text{C}$ , unless otherwise specified)		
		min.	typ.	max.
$g_{fs}$	$I_C = I_{C90}$ ; $V_{CE} = 10\text{ V}$ , Pulse test, $t \leq 300\ \mu\text{s}$ , duty cycle $\leq 2\%$	4	8	S
$C_{ies}$	$V_{CE} = 25\text{ V}$ , $V_{GE} = 0\text{ V}$ , $f = 1\text{ MHz}$		750	pF
$C_{oes}$			200	pF
$C_{res}$			30	pF
$Q_g$	$I_C = I_{C90}$ , $V_{GE} = 15\text{ V}$ , $V_{CE} = 0.5 V_{CES}$		52	70 nC
$Q_{ge}$			13	25 nC
$Q_{gc}$			24	45 nC
$t_{d(on)}$	<b>Inductive load, <math>T_J = 25^\circ\text{C}</math></b>		100	ns
$t_{ri}$	$I_C = I_{C90}$ , $V_{GE} = 15\text{ V}$ , $L = 300\ \mu\text{H}$ , $V_{CE} = 0.8 V_{CES}$ , $R_G = R_{off} = 150\ \Omega$		200	ns
$t_{d(off)}$			550	900 ns
$t_{fi}$	Remarks: Switching times may increase for $V_{CE}$ (Clamp) $> 0.8 \cdot V_{CES}$ , higher $T_J$ or increased $R_G$	10N100U1	800	ns
$E_{off}$		10N100AU1	500	ns
$E_{off}$		10N100AU1	2	3 mJ
$t_{d(on)}$	<b>Inductive load, <math>T_J = 125^\circ\text{C}</math></b>		100	ns
$t_{ri}$	$I_C = I_{C90}$ , $V_{GE} = 15\text{ V}$ , $L = 300\ \mu\text{H}$ , $V_{CE} = 0.8 V_{CES}$ , $R_G = R_{off} = 150\ \Omega$		200	ns
$E_{on}$			1.1	mJ
$t_{d(off)}$		600	1000 ns	
$t_{fi}$	Remarks: Switching times may increase for $V_{CE}$ (Clamp) $> 0.8 \cdot V_{CES}$ , higher $T_J$ or increased $R_G$	10N100U1	1250	2000 ns
$E_{off}$		10N100AU1	600	1000 ns
$E_{off}$		10N100U1	5.0	mJ
$E_{off}$		10N100AU1	2.5	mJ
$R_{thJC}$				1.2 K/W
$R_{thCK}$		0.25		K/W

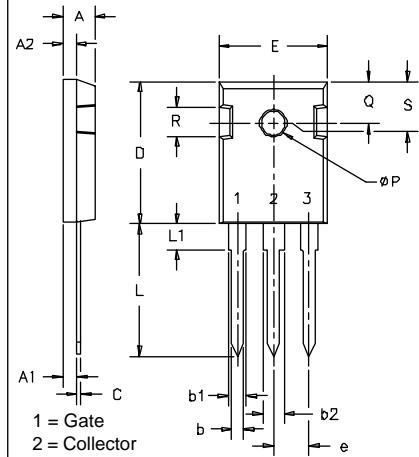
**TO-247 AD Outline**

SYM	INCHES		MILLIMETERS	
	MIN	MAX	MIN	MAX
A	.185	.209	4.7	5.3
A1	.087	.102	2.2	2.54
A2	.059	.098	2.2	2.6
b	.040	.055	1.0	1.4
b1	.065	.084	1.65	2.13
b2	.113	.123	2.87	3.12
C	.016	.031	.4	.8
D	.819	.845	20.80	21.46
E	.610	.640	15.75	16.26
e	.215 BSC		5.45 BSC	
L	.780	.800	19.81	20.32
L1		.177		4.50
phi P	.140	.144	3.55	3.65
Q	.212	.244	5.4	6.2
R	.170	.216	4.32	5.49
S	.242 BSC		6.15 BSC	

Symbol	Test Conditions	Characteristic Values ( $T_J = 25^\circ\text{C}$ , unless otherwise specified)		
		min.	typ.	max.
$V_F$	$I_F = I_{C90}$ , $V_{GE} = 0\text{ V}$ , Pulse test, $t \leq 300\ \mu\text{s}$ , duty cycle $d \leq 2\%$			2.75 V
$I_{RM}$	$I_F = I_{C90}$ , $V_{GE} = 0\text{ V}$ , $-di_F/dt = 100\text{ A}/\mu\text{s}$ $V_R = 540\text{ V}$ $T_J = 125^\circ\text{C}$ $I_F = 1\text{ A}$ ; $-di/dt = 50\text{ A}/\mu\text{s}$ ; $V_R = 30\text{ V}$ $T_J = 25^\circ\text{C}$		6.5	A
$t_{rr}$			120	ns
			50	60 ns
$R_{thJC}$				1.6 K/W

IXYS reserves the right to change limits, test conditions, and dimensions.

 IXYS MOSFETS and IGBTs are covered by one or more of the following U.S. patents: 4,835,592 4,881,106 5,017,508 5,049,961 5,187,117 5,486,715  
 4,850,072 4,931,844 5,034,796 5,063,307 5,237,481 5,381,025

Fig. 1 Saturation Characteristics

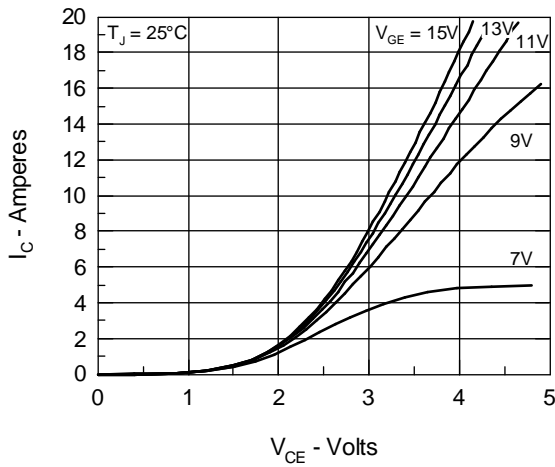

Fig. 2 Output Characteristics

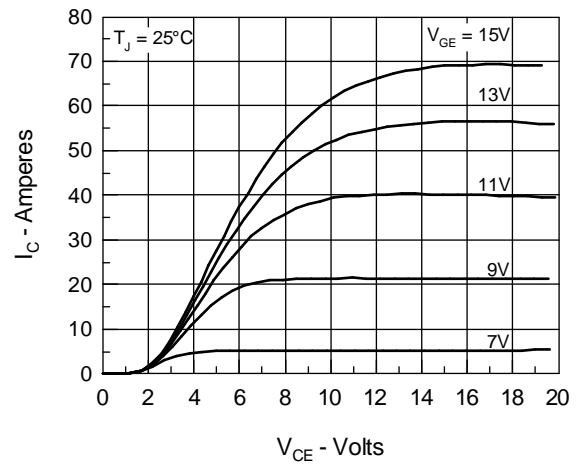

Fig. 3 Collector-Emitter Voltage vs. Gate-Emitter Voltage

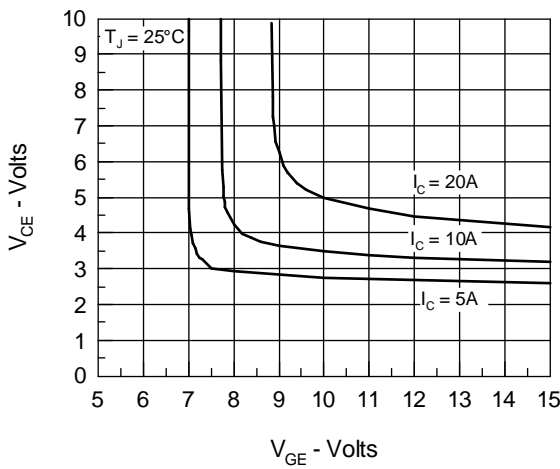

Fig. 4 Temperature Dependence of Output Saturation Voltage

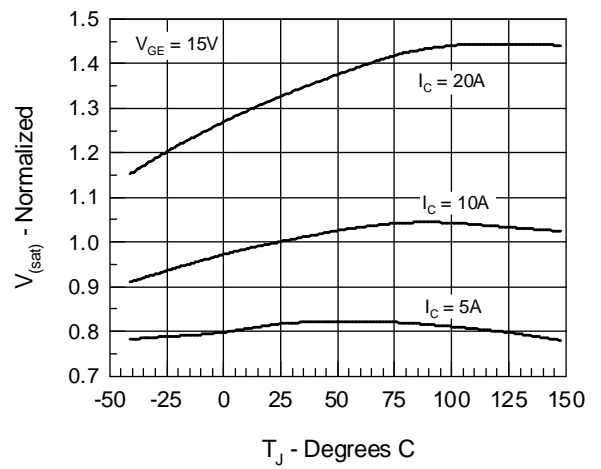

Fig. 5 Input Admittance

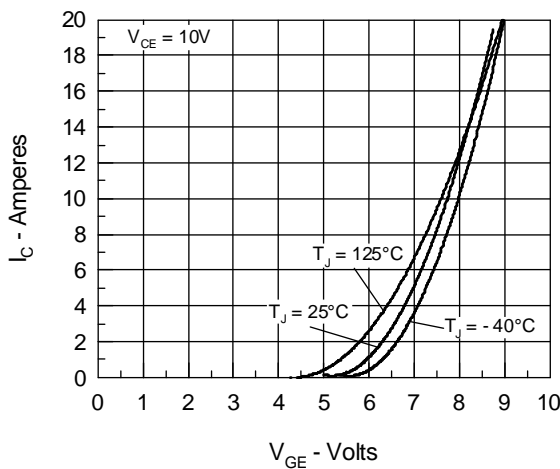

Fig. 6 Temperature Dependence of Breakdown and Threshold Voltage

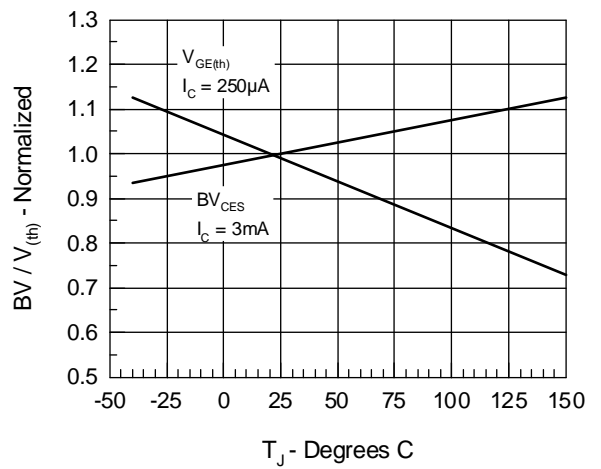

Fig.7 Turn-Off Energy per Pulse and Fall Time on Collector Current

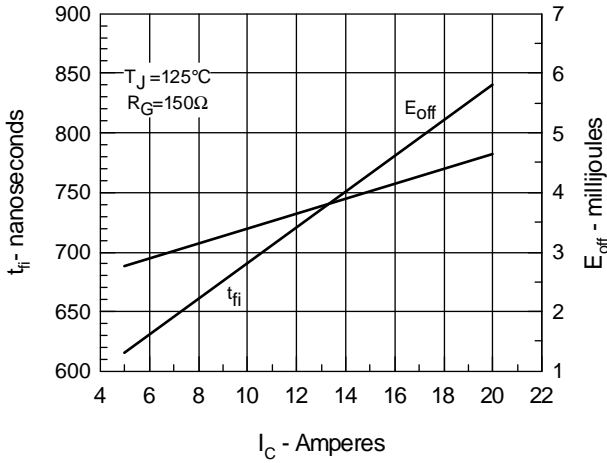

Fig.8 Dependence of Turn-Off Energy Per Pulse and Fall Time on R\_G

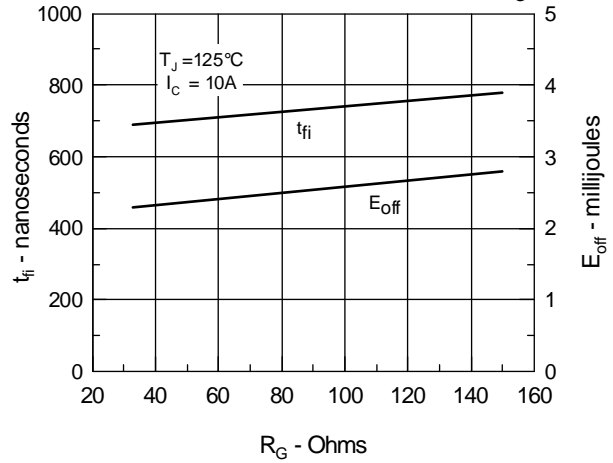

Fig.9 Gate Charge Characteristic Curve

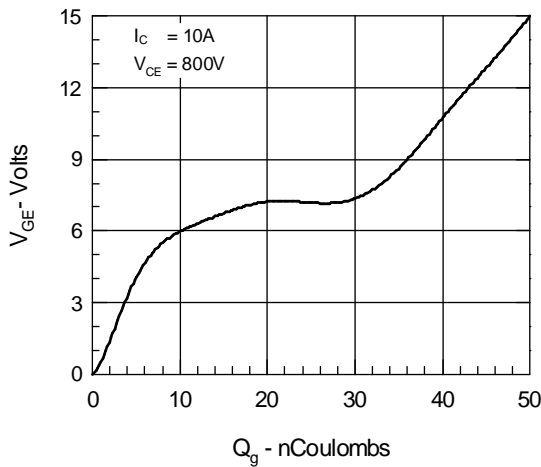

Fig.10 Turn-Off Safe Operating Area

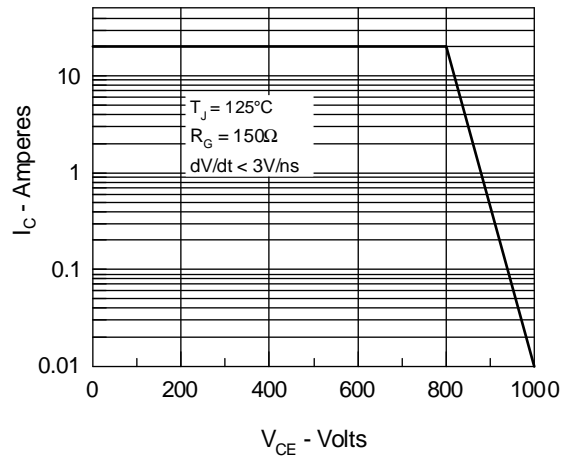
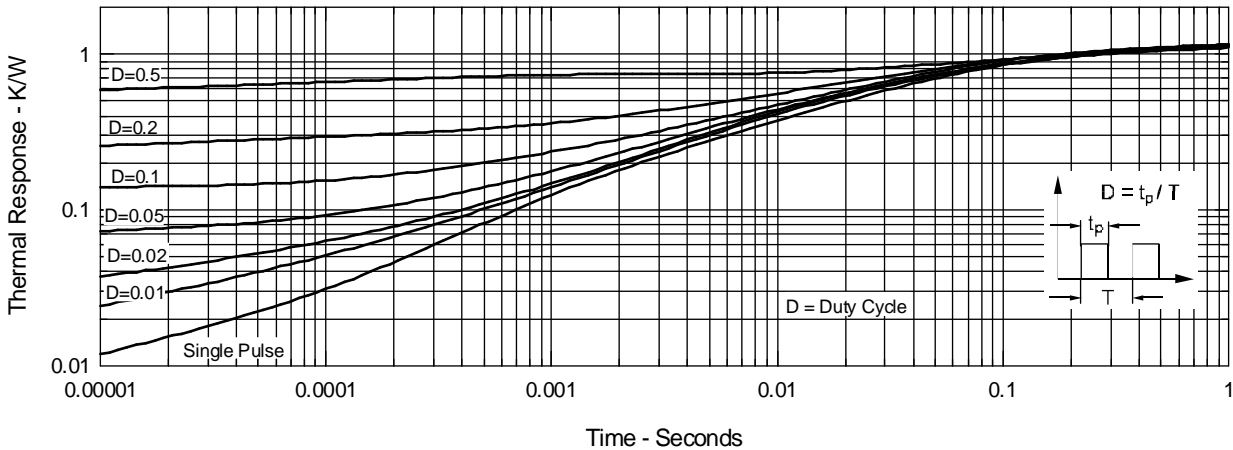

Fig.11 Transient Thermal Impedance



IXYS reserves the right to change limits, test conditions, and dimensions.

IXYS MOSFETS and IGBTs are covered by one or more of the following U.S. patents: 4,835,592 4,881,106 5,017,508 5,049,961 5,187,117 5,486,715  
4,850,072 4,931,844 5,034,796 5,063,307 5,237,481 5,381,025

Fig.12 Maximum Forward Voltage Drop

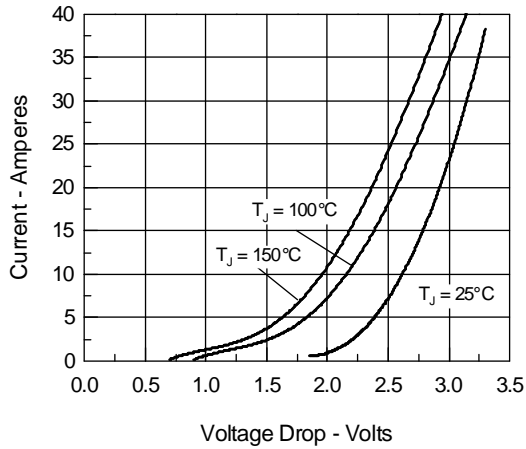

Fig.14 Junction Temperature Dependence off  $I_{RM}$  and  $Q_r$

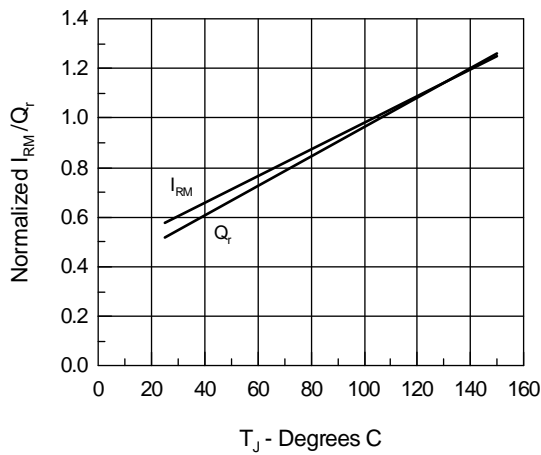

Fig.16 Peak Reverse Recovery Current

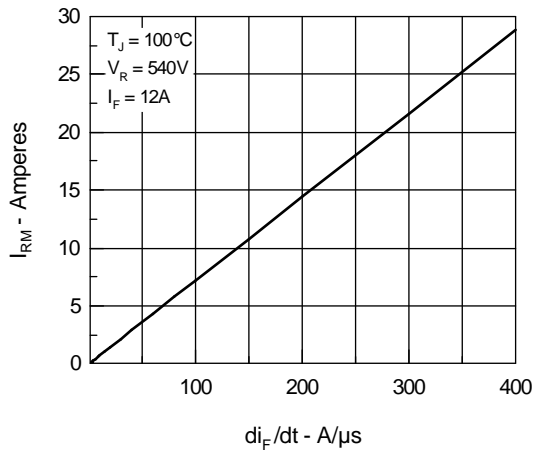

Fig.13 Peak Forward Voltage  $V_{FR}$  and Forward Recovery Time  $t_{FR}$

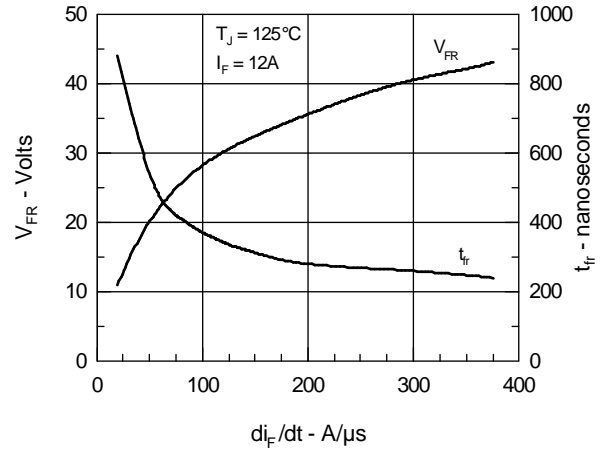

Fig.15 Reverse Recovery Charge

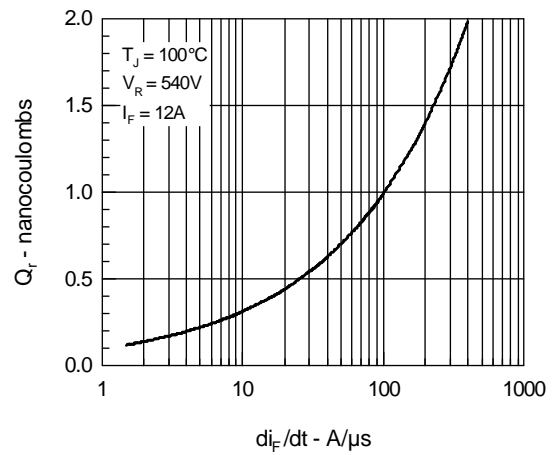

Fig.17 Reverse Recovery Time

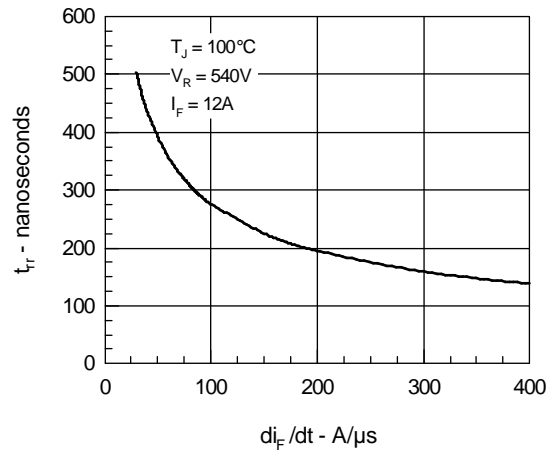
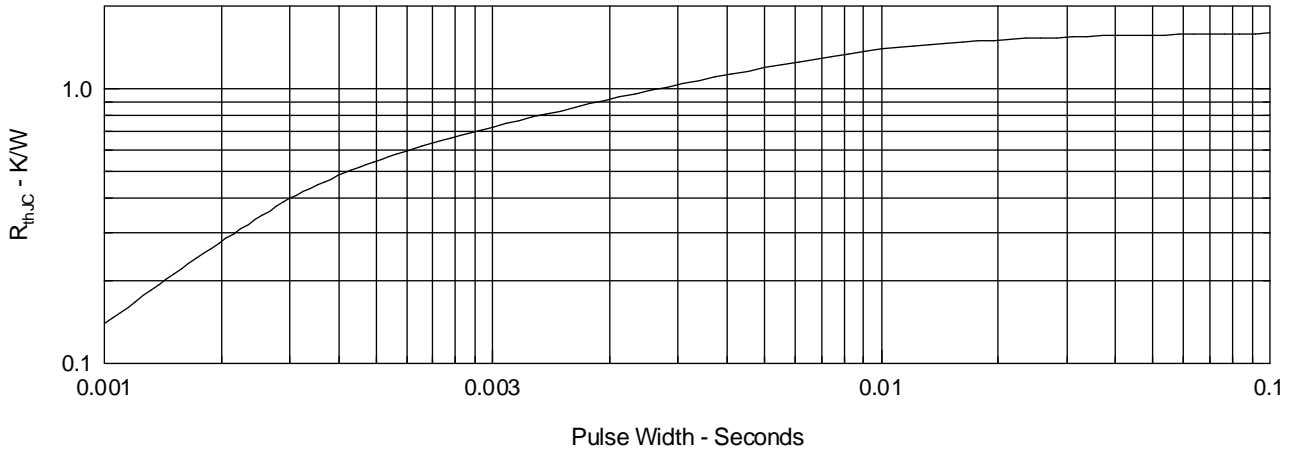

Fig.18 Diode Transient Thermal resistance junction to case



IXYS reserves the right to change limits, test conditions, and dimensions.

IXYS MOSFETS and IGBTs are covered by one or more of the following U.S. patents: 4,835,592 4,881,106 5,017,508 5,049,961 5,187,117 5,486,715  
4,850,072 4,931,844 5,034,796 5,063,307 5,237,481 5,381,025



## Стандарт Электрон Связь

Мы молодая и активно развивающаяся компания в области поставок электронных компонентов. Мы поставляем электронные компоненты отечественного и импортного производства напрямую от производителей и с крупнейших складов мира.

Благодаря сотрудничеству с мировыми поставщиками мы осуществляем комплексные и плановые поставки широчайшего спектра электронных компонентов.

Собственная эффективная логистика и склад в обеспечивает надежную поставку продукции в точно указанные сроки по всей России.

Мы осуществляем техническую поддержку нашим клиентам и предпродажную проверку качества продукции. На все поставляемые продукты мы предоставляем гарантию .

Осуществляем поставки продукции под контролем ВП МО РФ на предприятия военно-промышленного комплекса России , а также работаем в рамках 275 ФЗ с открытием отдельных счетов в уполномоченном банке. Система менеджмента качества компании соответствует требованиям ГОСТ ISO 9001.

Минимальные сроки поставки, гибкие цены, неограниченный ассортимент и индивидуальный подход к клиентам являются основой для выстраивания долгосрочного и эффективного сотрудничества с предприятиями радиоэлектронной промышленности, предприятиями ВПК и научно-исследовательскими институтами России.

С нами вы становитесь еще успешнее!

### Наши контакты:

**Телефон:** +7 812 627 14 35

**Электронная почта:** [sales@st-electron.ru](mailto:sales@st-electron.ru)

**Адрес:** 198099, Санкт-Петербург,  
Промышленная ул, дом № 19, литера Н,  
помещение 100-Н Офис 331