

Low $V_{CE(sat)}$ IGBT with Diode
High speed IGBT with Diode

IXGH 10 N100U1
IXGH 10 N100AU1

V_{CES}	I_{C25}	$V_{CE(sat)}$
1000 V	20 A	3.5 V
1000 V	20 A	4.0 V

Combi Packs

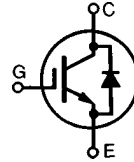

Symbol	Test Conditions	Maximum Ratings	
V_{CES}	$T_J = 25^\circ\text{C}$ to 150°C	1000	V
V_{CGR}	$T_J = 25^\circ\text{C}$ to 150°C ; $R_{GE} = 1\text{ M}\Omega$	1000	V
V_{GES}	Continuous	± 20	V
V_{GEM}	Transient	± 30	V
I_{C25}	$T_C = 25^\circ\text{C}$	20	A
I_{C90}	$T_C = 90^\circ\text{C}$	10	A
I_{CM}	$T_C = 25^\circ\text{C}$, 1 ms	40	A
SSOA (RBSOA)	$V_{GE} = 15\text{ V}$, $T_{VJ} = 125^\circ\text{C}$, $R_G = 150\ \Omega$ Clamped inductive load, $L = 300\ \mu\text{H}$	$I_{CM} = 20$ @ $0.8\ V_{CES}$	A
P_C	$T_C = 25^\circ\text{C}$	100	W
T_J		-55 ... +150	$^\circ\text{C}$
T_{JM}		150	$^\circ\text{C}$
T_{stg}		-55 ... +150	$^\circ\text{C}$
M_d	Mounting torque (M3)	1.13/10	Nm/lb.in.
Weight		6	g
Maximum lead temperature for soldering 1.6 mm (0.062 in.) from case for 10 s		300	$^\circ\text{C}$

TO-247 AD

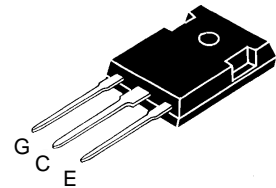

G = Gate, C = Collector,
E = Emitter, TAB = Collector

Features

- International standard package JEDEC TO-247 AD
- IGBT and anti-parallel FRED in one package
- 2nd generation HDMOS™ process
- Low $V_{CE(sat)}$
 - for low on-state conduction losses
- MOS Gate turn-on
 - drive simplicity
- Fast Recovery Epitaxial Diode (FRED)
 - soft recovery with low I_{RM}

Applications

- AC motor speed control
- DC servo and robot drives
- DC choppers
- Uninterruptible power supplies (UPS)
- Switch-mode and resonant-mode power supplies

Advantages

- Space savings (two devices in one package)
- Easy to mount with 1 screw (isolated mounting screw hole)
- Reduces assembly time and cost

Symbol	Test Conditions	Characteristic Values ($T_J = 25^\circ\text{C}$, unless otherwise specified)		
		min.	typ.	max.
BV_{CES}	$I_C = 4\text{ mA}$, $V_{GE} = 0\text{ V}$	1000		V
$V_{GE(th)}$	$I_C = 500\ \mu\text{A}$, $V_{CE} = V_{GE}$	2.5		5.5 V
I_{CES}	$V_{CE} = 0.8 \cdot V_{CES}$ $V_{GE} = 0\text{ V}$			$T_J = 25^\circ\text{C}$: 400 μA $T_J = 125^\circ\text{C}$: 5 mA
I_{GES}	$V_{CE} = 0\text{ V}$, $V_{GE} = \pm 20\text{ V}$			$\pm 100\text{ nA}$
$V_{CE(sat)}$	$I_C = I_{C90}$, $V_{GE} = 15\text{ V}$			10N100U1: 3.5 V 10N100AU1: 4.0 V

Symbol	Test Conditions	Characteristic Values ($T_J = 25^\circ\text{C}$, unless otherwise specified)		
		min.	typ.	max.
g_{fs}	$I_C = I_{C90}$; $V_{CE} = 10\text{ V}$, Pulse test, $t \leq 300\ \mu\text{s}$, duty cycle $\leq 2\%$	4	8	S
C_{ies}	$V_{CE} = 25\text{ V}$, $V_{GE} = 0\text{ V}$, $f = 1\text{ MHz}$		750	pF
C_{oes}			200	pF
C_{res}			30	pF
Q_g	$I_C = I_{C90}$, $V_{GE} = 15\text{ V}$, $V_{CE} = 0.5 V_{CES}$		52	70 nC
Q_{ge}			13	25 nC
Q_{gc}			24	45 nC
$t_{d(on)}$	Inductive load, $T_J = 25^\circ\text{C}$		100	ns
t_{ri}	$I_C = I_{C90}$, $V_{GE} = 15\text{ V}$, $L = 300\ \mu\text{H}$, $V_{CE} = 0.8 V_{CES}$, $R_G = R_{off} = 150\ \Omega$		200	ns
$t_{d(off)}$			550	900 ns
t_{fi}	Remarks: Switching times may increase for V_{CE} (Clamp) $> 0.8 \cdot V_{CES}$, higher T_J or increased R_G	10N100U1 10N100AU1	800 500	ns ns
E_{off}		10N100AU1	2	3 mJ
$t_{d(on)}$	Inductive load, $T_J = 125^\circ\text{C}$		100	ns
t_{ri}	$I_C = I_{C90}$, $V_{GE} = 15\text{ V}$, $L = 300\ \mu\text{H}$, $V_{CE} = 0.8 V_{CES}$, $R_G = R_{off} = 150\ \Omega$		200	ns
E_{on}			1.1	mJ
$t_{d(off)}$	Remarks: Switching times may increase for V_{CE} (Clamp) $> 0.8 \cdot V_{CES}$, higher T_J or increased R_G		600	1000 ns
t_{fi}		10N100U1 10N100AU1	1250 600	2000 1000 ns
E_{off}		10N100U1 10N100AU1	5.0 2.5	mJ mJ
R_{thJC}				1.2 K/W
R_{thCK}			0.25	K/W

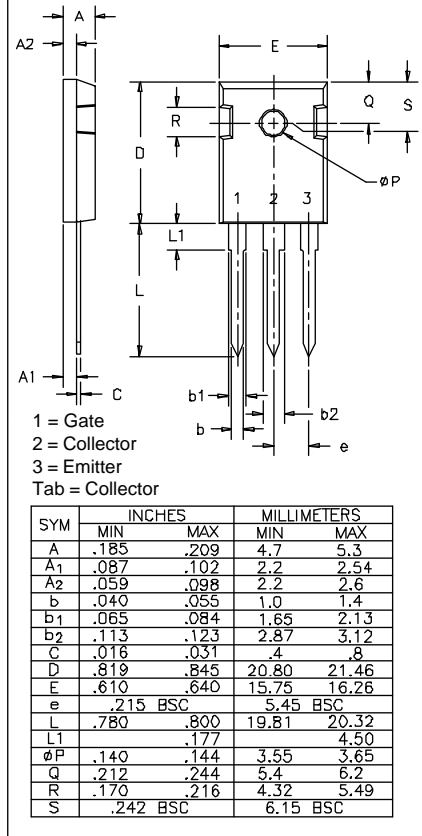
TO-247 AD Outline

Symbol	Test Conditions	Characteristic Values ($T_J = 25^\circ\text{C}$, unless otherwise specified)		
		min.	typ.	max.
V_F	$I_F = I_{C90}$, $V_{GE} = 0\text{ V}$, Pulse test, $t \leq 300\ \mu\text{s}$, duty cycle $d \leq 2\%$			2.75 V
I_{RM}	$I_F = I_{C90}$, $V_{GE} = 0\text{ V}$, $-di_F/dt = 100\text{ A}/\mu\text{s}$ $V_R = 540\text{ V}$ $T_J = 125^\circ\text{C}$ $I_F = 1\text{ A}$; $-di/dt = 50\text{ A}/\mu\text{s}$; $V_R = 30\text{ V}$ $T_J = 25^\circ\text{C}$		6.5	A
t_{rr}			120	ns
			50	60 ns
R_{thJC}				1.6 K/W

IXYS reserves the right to change limits, test conditions, and dimensions.

 IXYS MOSFETS and IGBTs are covered by one or more of the following U.S. patents: 4,835,592 4,881,106 5,017,508 5,049,961 5,187,117 5,486,715
 4,850,072 4,931,844 5,034,796 5,063,307 5,237,481 5,381,025

Fig. 1 Saturation Characteristics

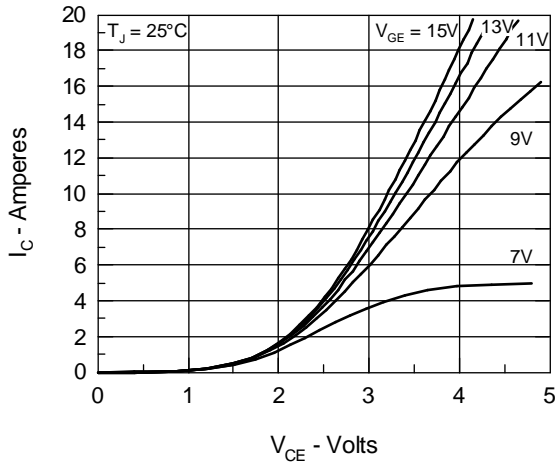

Fig. 2 Output Characteristics

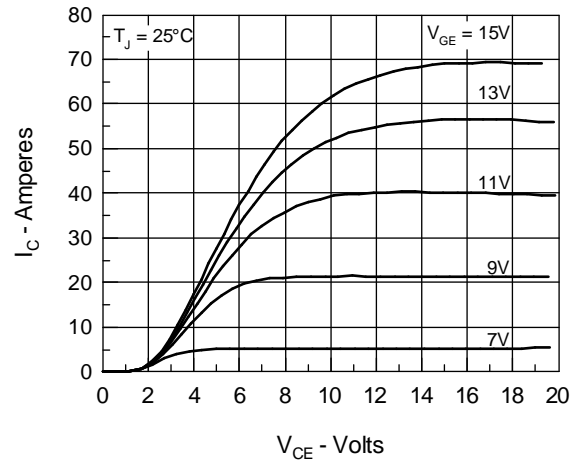

Fig. 3 Collector-Emitter Voltage vs. Gate-Emitter Voltage

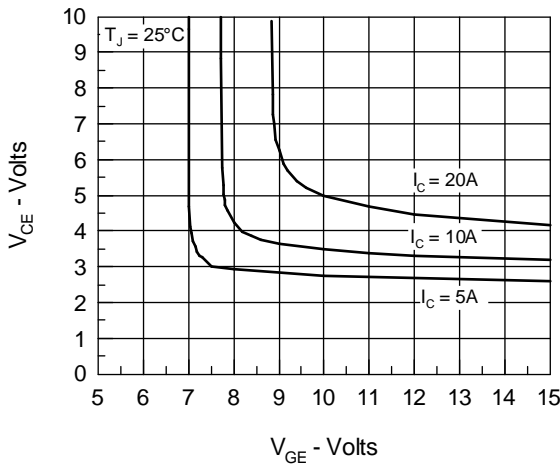

Fig. 4 Temperature Dependence of Output Saturation Voltage

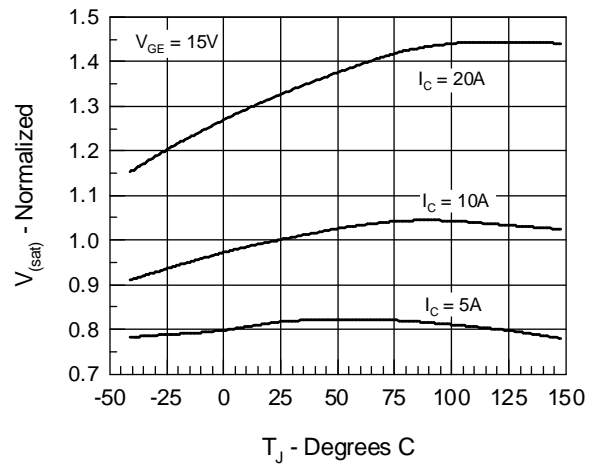

Fig. 5 Input Admittance

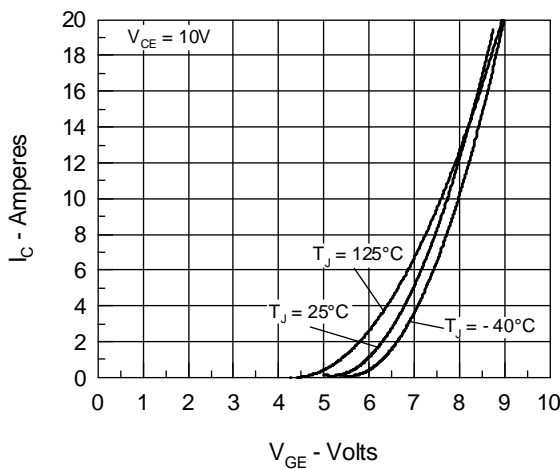

Fig. 6 Temperature Dependence of Breakdown and Threshold Voltage

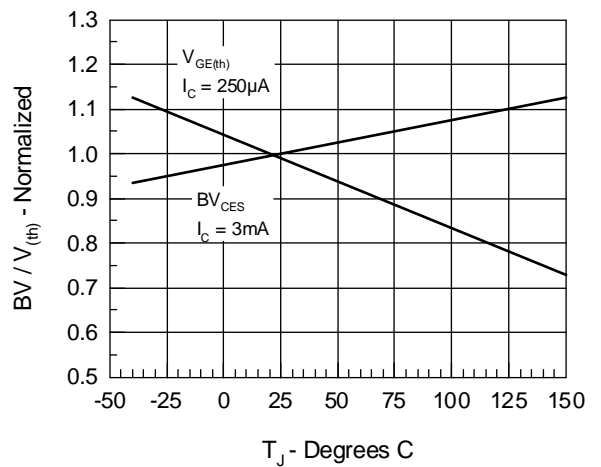

Fig.7 Turn-Off Energy per Pulse and Fall Time on Collector Current

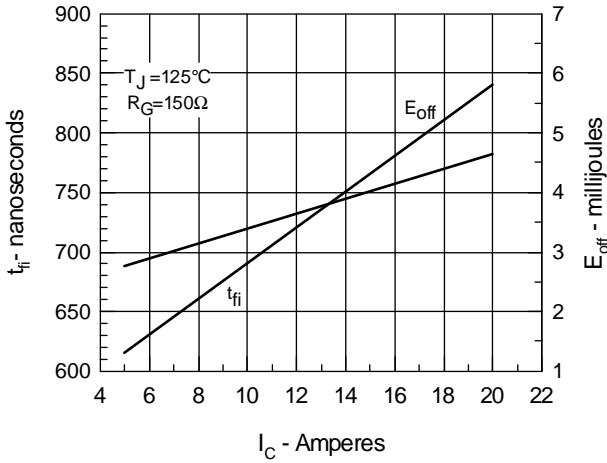

Fig.8 Dependence of Turn-Off Energy Per Pulse and Fall Time on R_G

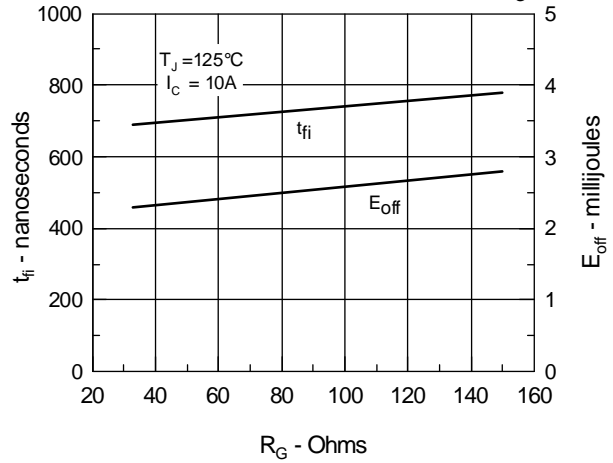

Fig.9 Gate Charge Characteristic Curve

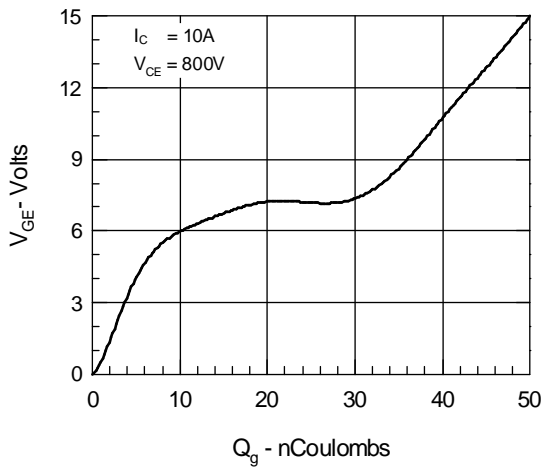

Fig.10 Turn-Off Safe Operating Area

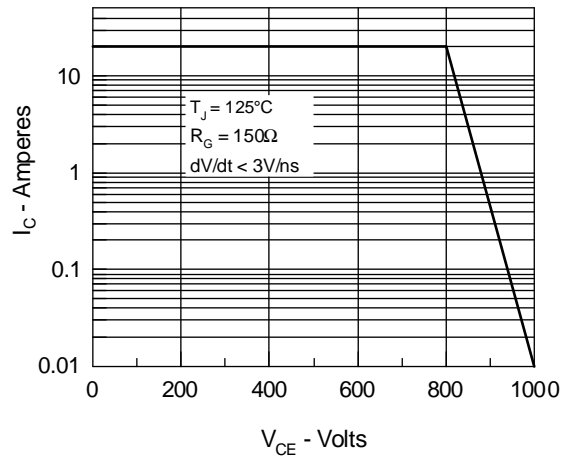
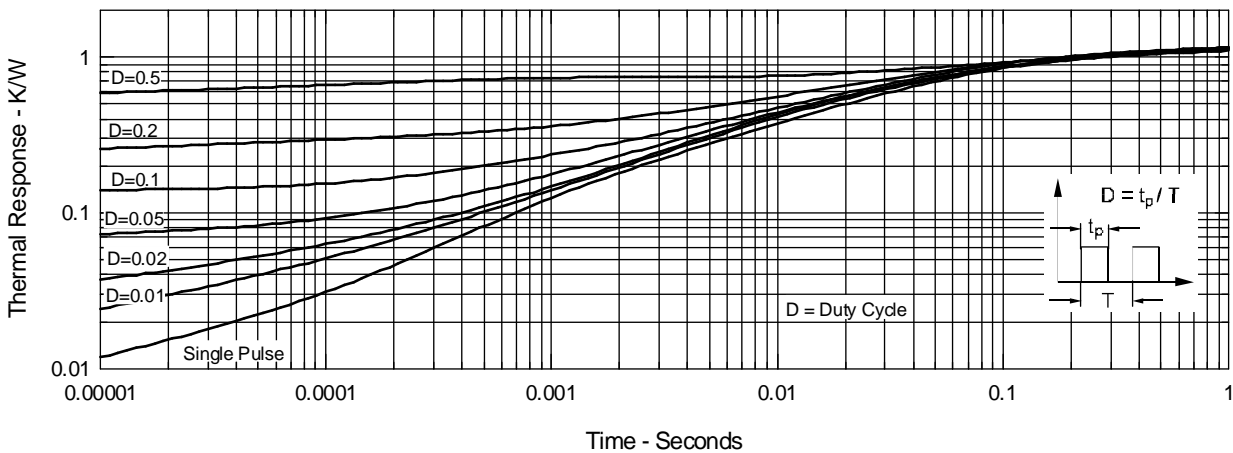

Fig.11 Transient Thermal Impedance



IXYS reserves the right to change limits, test conditions, and dimensions.

IXYS MOSFETS and IGBTs are covered by one or more of the following U.S. patents: 4,835,592 4,881,106 5,017,508 5,049,961 5,187,117 5,486,715
4,850,072 4,931,844 5,034,796 5,063,307 5,237,481 5,381,025

Fig.12 Maximum Forward Voltage Drop

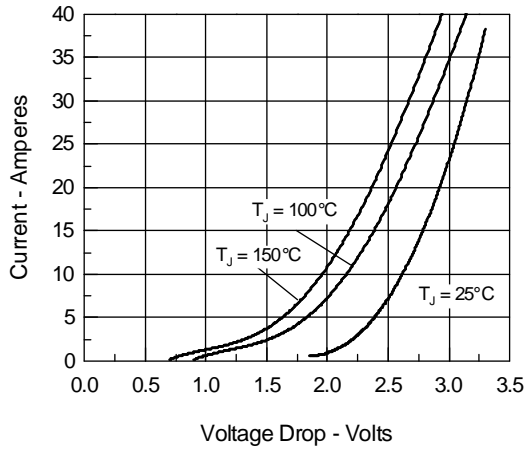

Fig.14 Junction Temperature Dependence off I_{RM} and Q_r

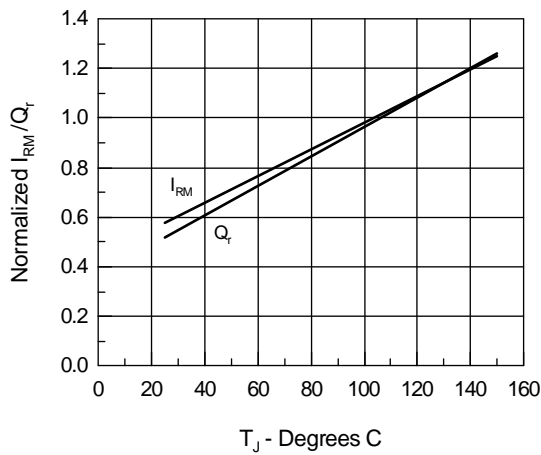

Fig.16 Peak Reverse Recovery Current

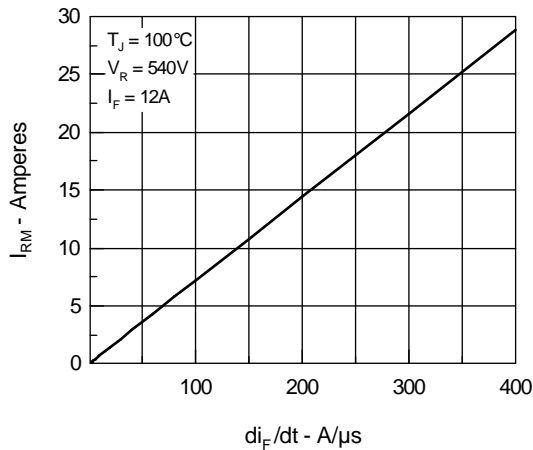

Fig.13 Peak Forward Voltage V_{FR} and Forward Recovery Time t_{FR}

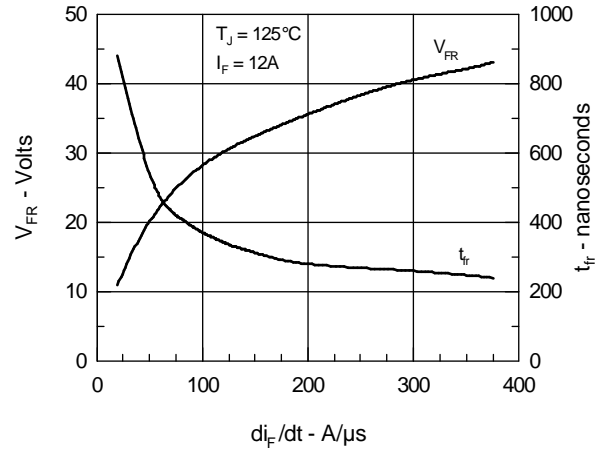

Fig.15 Reverse Recovery Charge

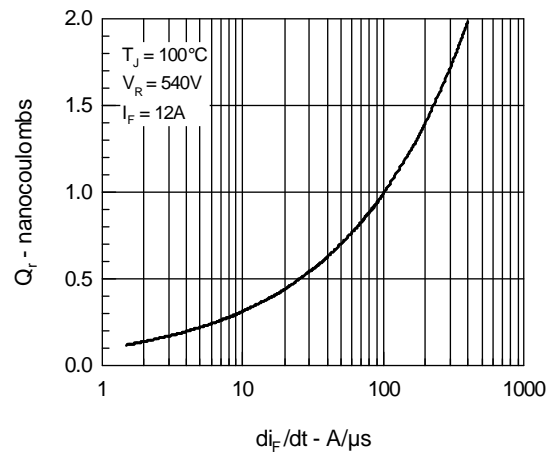

Fig.17 Reverse Recovery Time

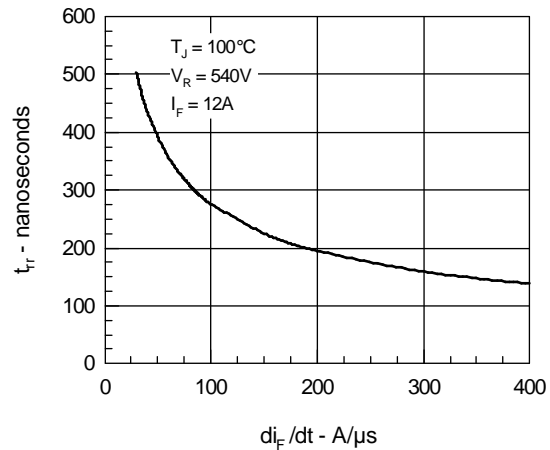
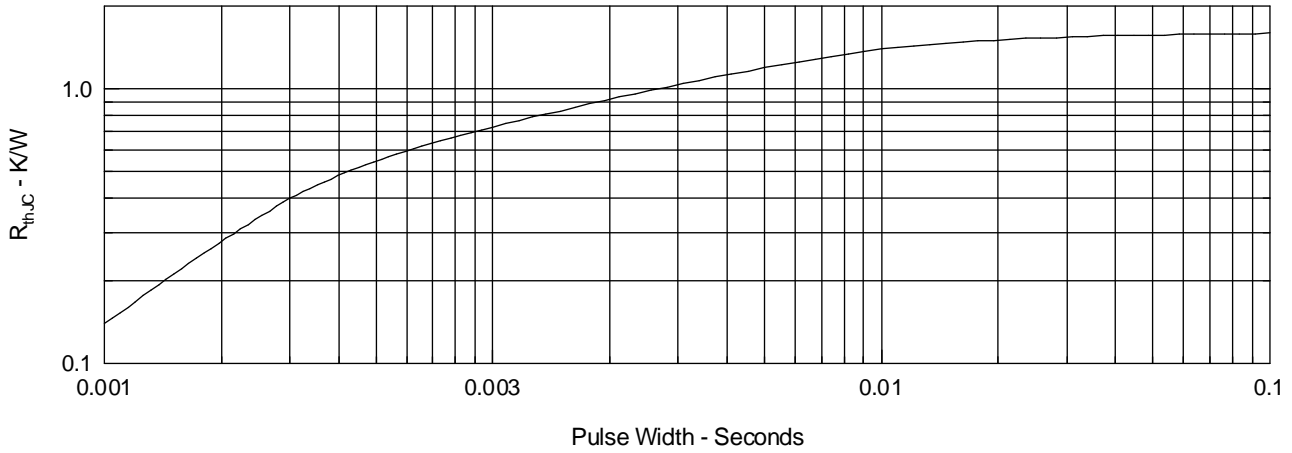

Fig.18 Diode Transient Thermal resistance junction to case



IXYS reserves the right to change limits, test conditions, and dimensions.

IXYS MOSFETS and IGBTs are covered by one or more of the following U.S. patents: 4,835,592 4,881,106 5,017,508 5,049,961 5,187,117 5,486,715
4,850,072 4,931,844 5,034,796 5,063,307 5,237,481 5,381,025



**Стандарт
Электрон
Связь**

Мы молодая и активно развивающаяся компания в области поставок электронных компонентов. Мы поставляем электронные компоненты отечественного и импортного производства напрямую от производителей и с крупнейших складов мира.

Благодаря сотрудничеству с мировыми поставщиками мы осуществляем комплексные и плановые поставки широчайшего спектра электронных компонентов.

Собственная эффективная логистика и склад в обеспечивает надежную поставку продукции в точно указанные сроки по всей России.

Мы осуществляем техническую поддержку нашим клиентам и предпродажную проверку качества продукции. На все поставляемые продукты мы предоставляем гарантию .

Осуществляем поставки продукции под контролем ВП МО РФ на предприятия военно-промышленного комплекса России , а также работаем в рамках 275 ФЗ с открытием отдельных счетов в уполномоченном банке. Система менеджмента качества компании соответствует требованиям ГОСТ ISO 9001.

Минимальные сроки поставки, гибкие цены, неограниченный ассортимент и индивидуальный подход к клиентам являются основой для выстраивания долгосрочного и эффективного сотрудничества с предприятиями радиоэлектронной промышленности, предприятиями ВПК и научно-исследовательскими институтами России.

С нами вы становитесь еще успешнее!

Наши контакты:

Телефон: +7 812 627 14 35

Электронная почта: sales@st-electron.ru

Адрес: 198099, Санкт-Петербург,
Промышленная ул, дом № 19, литера Н,
помещение 100-Н Офис 331