

ANTENNA SELECTION GUIDE FOR THE 868 MHz EZRADIO® AND EZRADIOPRO® DESIGNS

1. Introduction

This document describes the nine different 50 Ω single-ended antenna types used in the easy-to-use 868 MHz Antenna Matrix (WES0030-01-AMS868-01), which is dedicated to the EZRadio and EZRadioPRO family. Using the development tool, the reader can test the performance of the Silicon Labs' RFIC radio family with different types of antennas and then find the best solution for the application in terms of shape, size, cost, and expected range.

The antenna types in the matrix are selected for the most common application areas in the 868 MHz band. The antennas are optimized and tuned for the antenna PCB + Pico Board + Motherboard (MSC-WMB930 Wireless Motherboard) structure (see Figure 1).

The input impedance, radiation pattern, and antenna gain of every antenna type in the Matrix are measured with the above configuration. The outdoor range is also checked using two identical antenna modules at the two sides of the link. The results are given in a separate document containing measurement reports for each antenna type.

In typical customer cases the antennas are applied without the nearby Pico Board and Motherboard, and therefore their effects disappear. Since all customer applications are different, the right solution may not be found among these fixed size, fixed form factor Matrix antennas.

For these outlying cases, Silicon Labs recommends the user modify/tune the printed ILA (Inverted L Antenna) and IFA (Inverted F Antenna) types, which are customizable in terms of length and performance. Silicon Labs provides an easy-to-understand, simple, step-by-step tuning process description in the Application Note entitled "Antenna Design Guide for Single-Ended 50 Ω Antennas". Use this Application Note to customize and optimize the performance of these antennas.

The current Matrix is designed for 50 Ω single-ended solutions. Another matrix will be devoted to the differential, high-impedance antennas, which are supported by the Si4010 /12/ RF IC family.

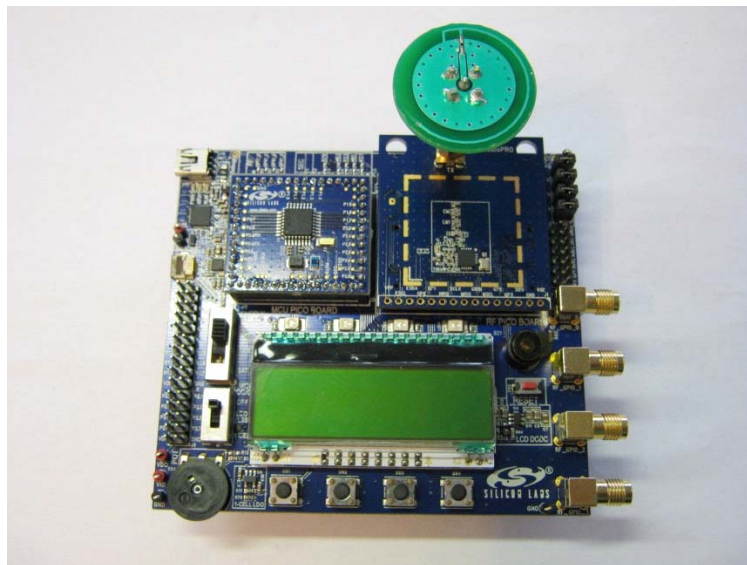

Figure 1. Typical Measurement Configuration—Antenna Board, Pico Board, and Wireless Motherboard

2. General Notes

The following apply.

- EZRadio and EZRadioPRO family of products are supported
- RF Pico Boards equipped with Si4x55, Si4456, or Si446x can be used with these antennas
- RF connectors are matched to 50 Ω
- Boards are equipped with female SMA connectors
 - Antenna can be connected to the Pico Board using an SMA male-to-male straight adapter
- MSC-WMB930 Wireless Motherboard serves as the driving interface of the Pico Board (Figure 1)
- 41 mm wide Pico Boards -> max. 41 mm wide antenna panels
- All PCB antennas are designed on 1.55 mm thick FR4 substrate

3. Antenna Type Description and Typical Applications

The PCB plot of the WES0030-01-AMS868-01 868 MHz Antenna Matrix is shown in Figure 2. For the 868 MHz band nine different PCB antenna solutions are proposed:

- Medium Size Printed ILA (or optionally IFA) around the PCB circumference (WES0031-01-APL868M-01)
- Ceramic (Chip) Antenna (WES0032-01-ACM868D-01)
- Small Size (Wire) Helical Antenna (WES0033-01-AWH868S-01)
- Medium Size (Wire) Helical Antenna (WES0034-01-AWH868M-01)
- Panic Button ILA (Printed) along the circumference (WES0035-01-APF868P-01)
- Panic Button IFA (Printed) along the circumference (WES0036-01-APL868P-01)
- Printed Meander Monopole (WES0037-01-APN868D-01)
- Small Size Printed ILA (or optional IFA) in dedicated small antenna area (WES0038-01-APL868S-01)
- Printed BIFA in a dedicated bigger antenna area (WES0039-01-APB868D-01)

The position of the antennas within the Antenna Matrix is shown in Figure 3.

In addition to testing the range of the antennas in the antenna matrix, the range is also tested using a commercially available external whip reference antenna.

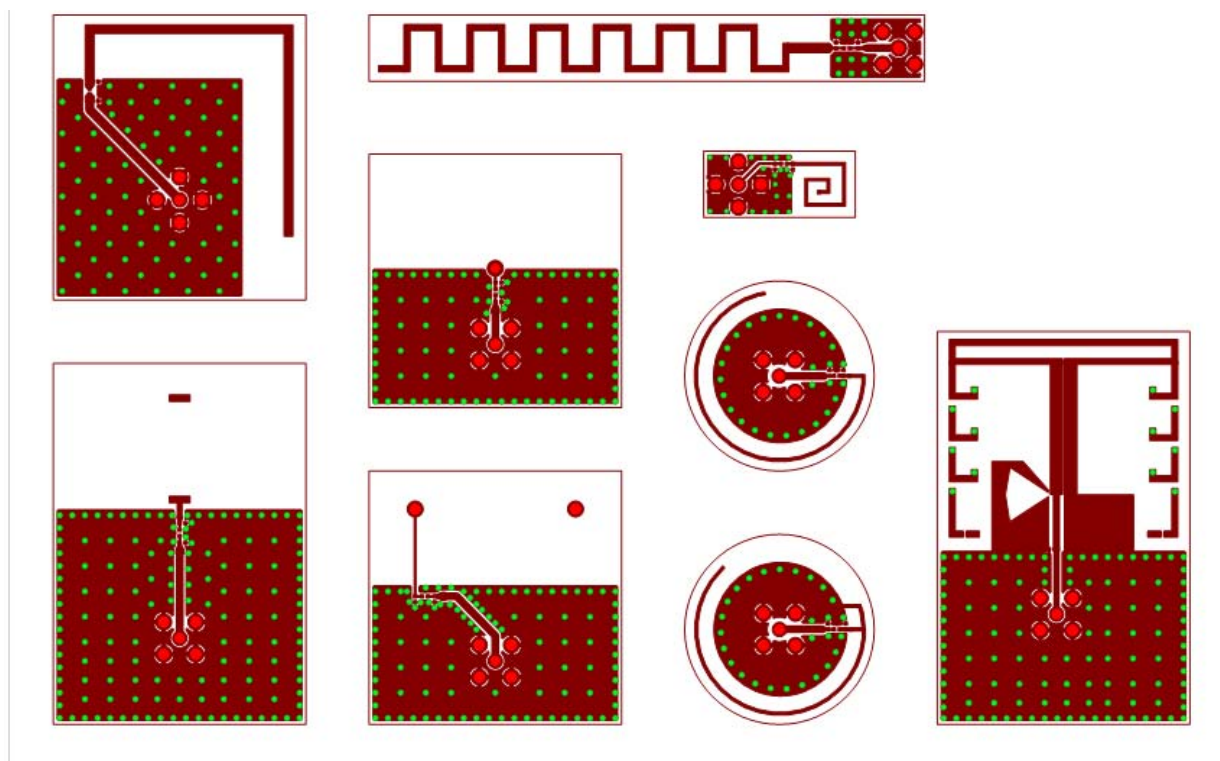

Figure 2. PCB Plot WES0030-01-AMS868-01 868-MHz Antenna Matrix

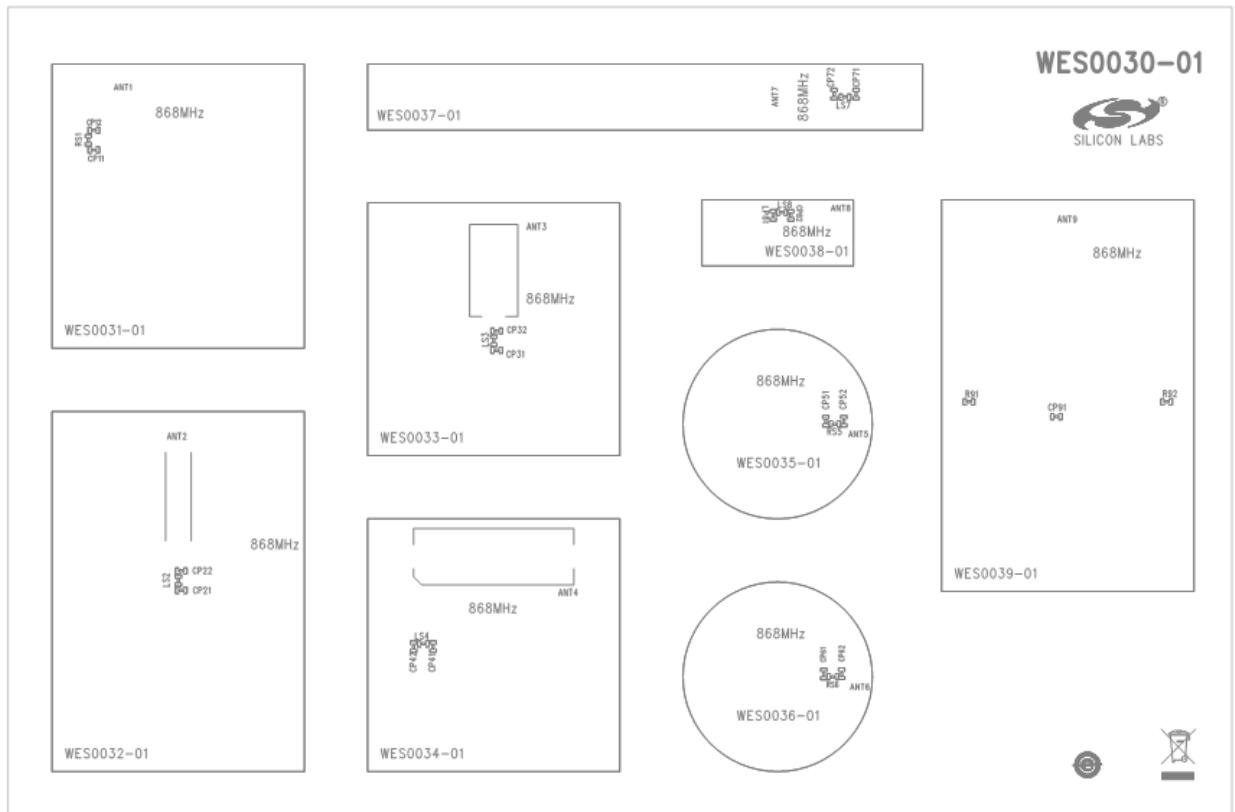

Figure 3. Antenna Positions in the Matrix

3.1. Typical Applications of the Antenna Types,

Each antenna type described in this section has advantages and disadvantages relative to context and intended use.

Medium Size Printed ILA (or optionally IFA) around the PCB circumference (WES0031-01-APL868M-01): This is a low-cost, printed monopole antenna. This type uses a narrow PCB strip around the PCB circumference as the antenna area, thereby saving significant space. The drawback is the reduced gain. This is especially true if the antenna trace is close to the ground metal of the circuitry. This antenna type is sensitive to hand effect, so bench tuning with hand in place is required. But the hand effect can also improve the radiation if the hand covers mostly or only the circuit area.

Due to these properties, this antenna type is frequently used in key fobs, where the range requirement is usually moderate.

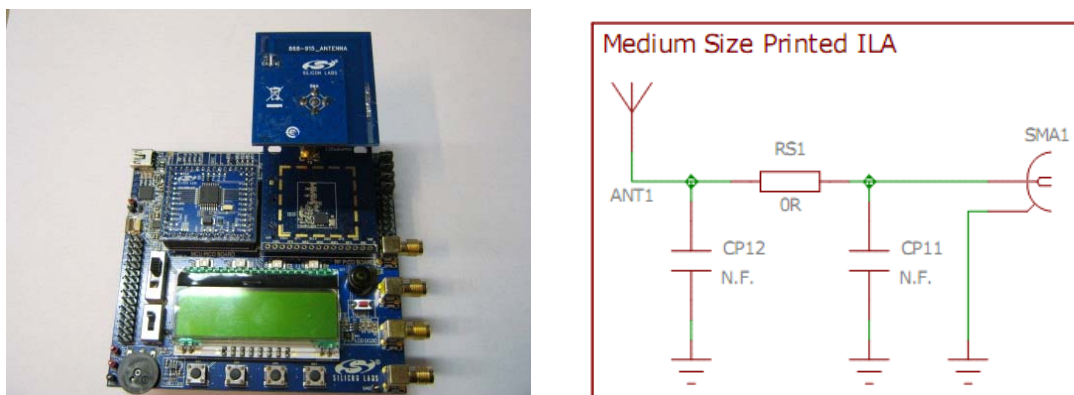

Figure 4. Medium Size Printed ILA

Ceramic (Chip) Antenna (WES0032-01-ACM868D-01): This type of antenna usually requires a relatively large circuit area with the gaps filled in with ground metal. This antenna type is a very good, high-gain, smaller alternative to any printed antenna. However, the cost of the chip antenna is higher. It is typically used in set top boxes and AMRs, where the slight additional cost can be tolerated.

Chip antennas are usually realized on high epsilon dielectric, so the hand effect has less influence on them, unless the PCB circuitry area (with ground metal) is small. The reason is that the increase of a small ground size by the hand changes (usually improves) the radiation. Bench tuning of the impedance with hand is still required.

Chip antennas are not generally used in key fobs due to their relatively higher price.

The antenna used in the Matrix is the ANT-868-CHP-T from the Antenna Factor. With the applied antenna PCB ground size, this antenna requires a two element external matching network at the input.

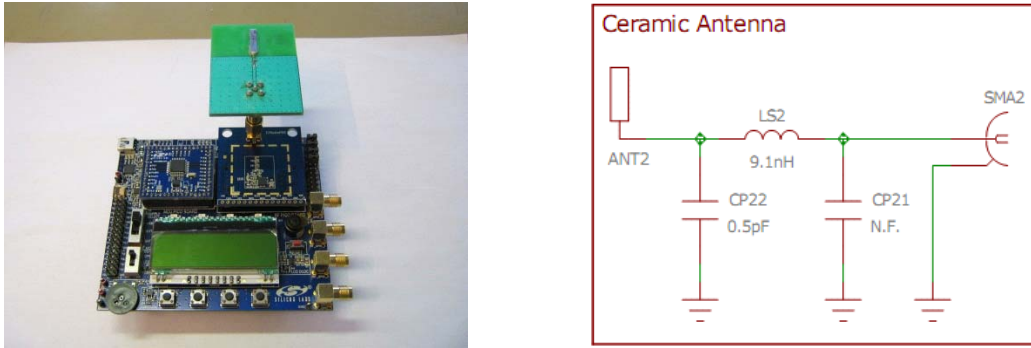

Figure 5. WES0032-01-ACM868D-01

Small Size (Wire) Helical Antenna parallel with the PCB (WES0033-01-AWH868S-01): This antenna is a popular, very small, low-cost alternative to the external whip antenna, but it has a lower gain. At lower frequencies the gain can be improved by using a ferrite in it. This type of antenna is typically used in set top boxes, AMRs, alarm systems, and key fobs.

The small helical antenna used in the Matrix is the ANT-868-JJB-RA from the Antenna Factor. Due to the small size of the antenna PCB (ground), an additional external matching network is required at the antenna input (Figure 6.). The helical monopole is sensitive to hand effect, even if only the circuit (ground) area of the antenna PCB is touched, which in effect causes the ground size around the antenna to change. Because of this hand effect the modification (or elimination) of the above mentioned external matching network is required.

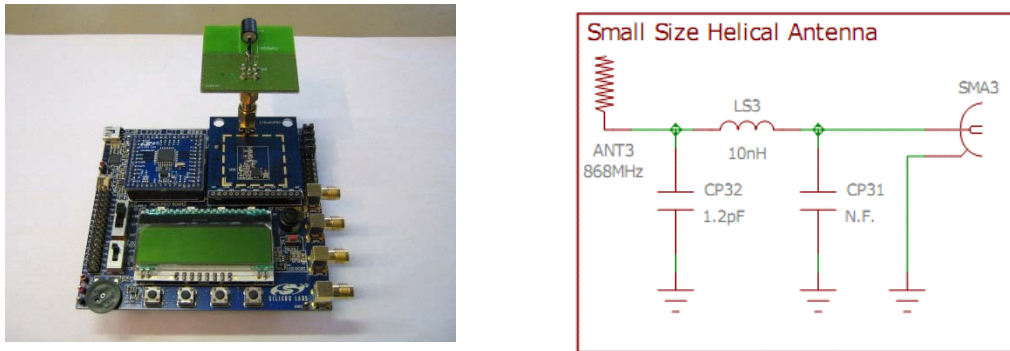

Figure 6. WES0033-01-AWH868S-01

Medium Size (Wire) Helical Antenna (WES0034-01-AWH868M-01): This type of antenna is a popular, small, low-cost, wire alternative to the external whip antenna, but it has a lower gain. At lower frequencies the gain can be improved by using a ferrite in it. Typically this type of antenna is used in key fobs, set top boxes, AMRs, and alarm systems. In this matrix the ANT-916-HETH from the Antenna Factor is selected with an additional external series 8.2 nH matching inductor at the antenna input to tune it down to 868 MHz.

The helical monopole is sensitive to hand effect, which is true even if only the circuit (ground) area of the PCB is touched and the ground size is small. In this case, the ground size around the antenna changes (the radiation usually improves). Because of the hand effect further tuning of the matching network is necessary.

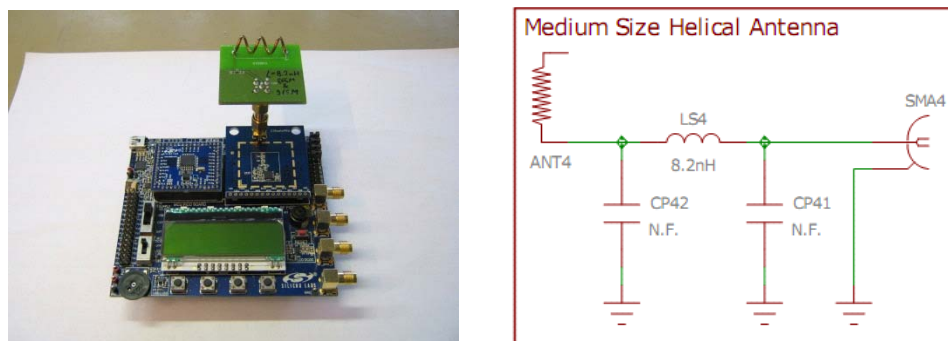

Figure 7. WES0034-01-AWH868M-01

Panic Button ILA (WES0035-01-APF868P-01) and Panic Button IFA (WES0036-01-APL868P-01) along the circumference: These type of antennas are very low-cost, small monopole type antennas. Typically they fully surround the small circuitry along the PCB edge, which allows them to have the highest possible radiation efficiency and make impedance tuning easier.

These antennas are basically the same as the first antenna type (e.g. WES0031-01-APL868M-01). The antenna trace also runs along the PCB circumference, but the PCB is significantly smaller.

Due to the very small size, the gain is low, especially at low frequency bands, and these solutions are also sensitive to the hand effect. Typically, these antennas are used in wristband panic buttons applications, where strong hand effect exists. Here the antenna is parallel with the hand, and, thus, the hand degrades the radiation. Fortunately, the range requirement is also low in most cases.

The main difference between the ILA and IFA is that the ILA needs a parallel matching capacitor (5.6 pF here) at the input, while the IFA is inherently matched. However, the post tuning of the ILA is easier. In the upcoming document “Antenna Design Guide for Single Ended 50 Ω Antennas,” Silicon Labs will provide a detailed description of the tuning process, both for the ILA and IFA antennas. The panic button antennas given in this Matrix are tuned without hand effect, so the range achieved with them is better than what one could see with the hand effect.

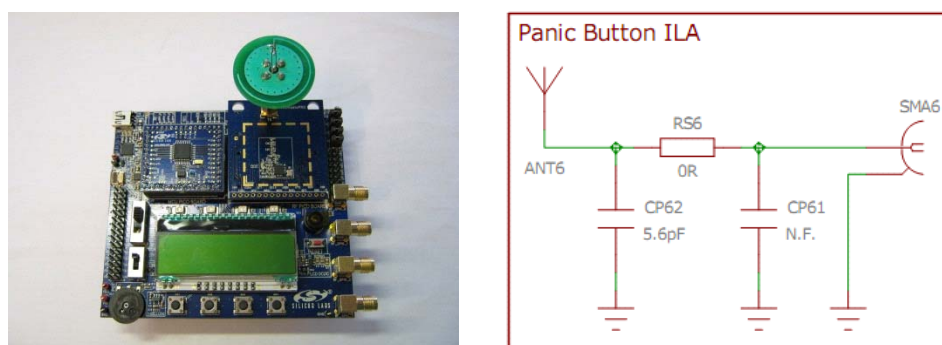

Figure 8. WES0035-01-APF868P-01

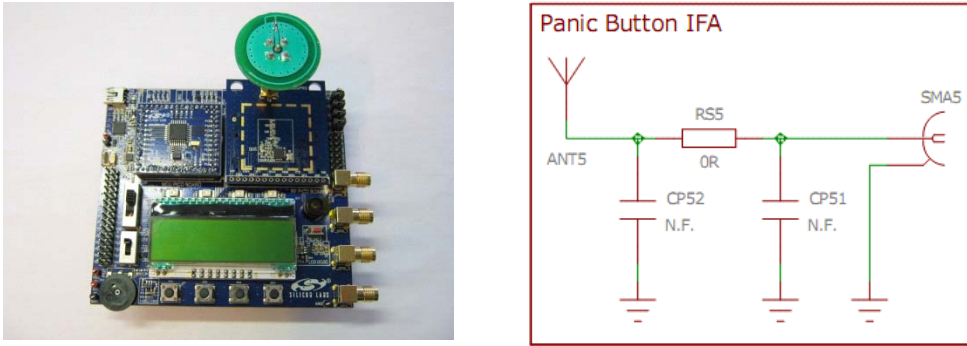

Figure 9. WES0036-01-APL868P-01

Printed Meander Monopole (WES0037-01-APN868D-01): This type is a low cost, reduced size, printed alternative to the external whip antenna, but it requires a separate antenna area, which is larger than the space required by a typical printed ILA or IFA, around the PCB circumference or by a wire helical antenna. On the other hand, it has higher gain as well.

If the meander antenna is put on a separate PCB, then it works best if the antenna PCB is perpendicular to the circuit PCB or to a large ground metal. The gain is significantly better than that of a PCB circumference printed ILA or a wire helical antenna.

The meander antenna is sensitive to hand effect. As usual, the hand can improve radiation if the hand covers the circuit area only.

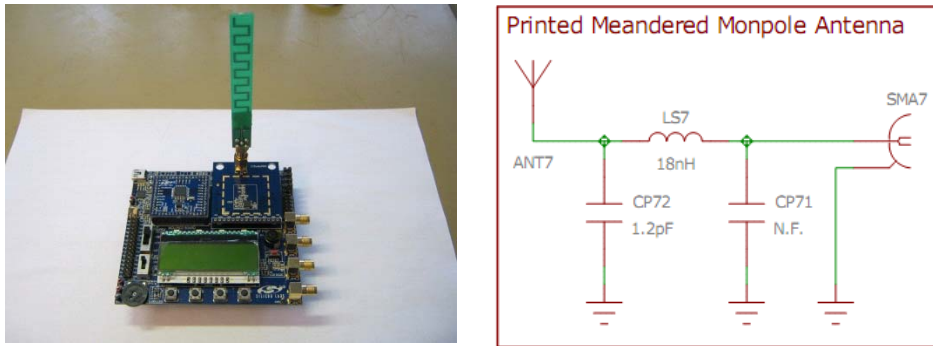

Figure 10. WES0037-01-APN868D-01

Small Size Printed ILA (or optionally IFA) in dedicated small antenna area (WES0038-01-APL868S-01): This type of antenna is typically used in dongles and key fobs, where a limited-size, separate antenna area is available and where there is not enough space along the PCB circumference for a good antenna. The gain is limited, but the presence of a nearby hand or a large amount of metal (exp., computer chassis) can improve gain significantly if only the circuit area of the PCB is covered. The best situation is if the hand or the ground metal is perpendicular to the antenna plane.

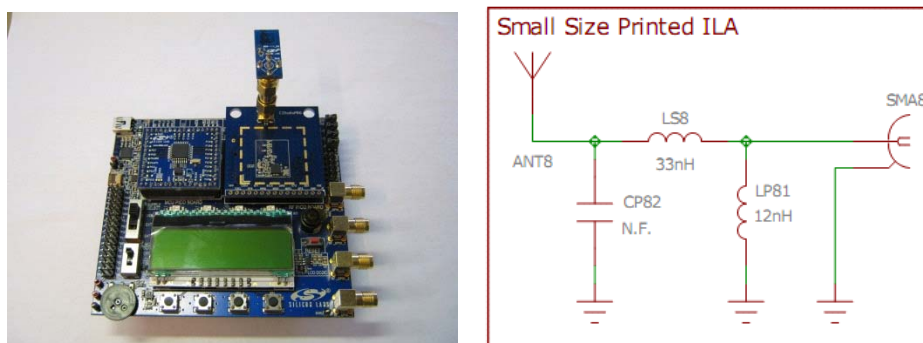

Figure 11. WES0038-01-APL868S-01

Balanced IFA (BIFA) on a larger separate antenna area (WES0039-01-APB868D-01): Due to their bigger size, these antennas have good gain. But the biggest advantage is that the radiation pattern is not influenced too much by the PCB ground size and shape, due to the balanced operation of the antenna (the BIFA antenna is differential and a printed balun is used at the input to connect it to the $50\ \Omega$ single-ended Pico Board input/output). Due to this, the performance of the BIFA antenna is nearly the same without the Pico Board or Motherboard.

Another advantage is that the BIFA antenna mostly radiates to the direction of the antenna's symmetrical axis (more precisely: it radiates mainly along a plane which includes the symmetrical axis and perpendicular to the antenna PCB).

Unfortunately, the BIFA is sensitive to hand effect, if the antenna traces are directly touched. But, it is not sensitive, if only the ground (circuit) part of the PCB is touched.

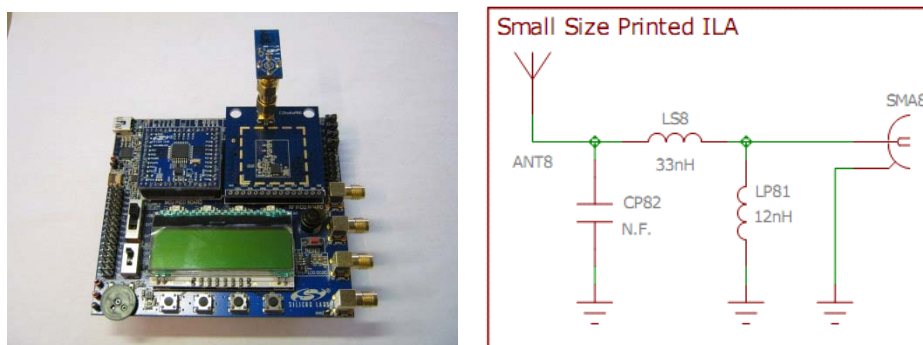

Figure 12. WES0039-01-APB868D-01

4. Documentation

Each antenna type has its own separate description and documentation which contains the following:

- Antenna match schematic (if it exists)
- Top and bottom layout
- Picture
- Measured Impedance
- Measured antenna gain
- Measured radiation pattern
- Harmonic radiation (up to 10th harm)
- Range measurements

The documentation for each antenna includes a manufacturing pack as well downloadables from the web page.

5. Range Measurements

Several open-site range tests were made with every antenna type at 50 kbps and 100 kbps with different orientations and polarizations. In these tests, the same matrix antenna board is used both at the TX and RX site. Also, the results were compared with the range test results between two units using the reference monopole (ANT-868-CW-HWR-SMA). More details can be found in the "range test" subchapters of application note AN782.

In one of the range test measurements, as documented in AN782, the RX and TX antenna face each other in their maximum radiation orientation. Here the antenna PCB or axis is vertically polarized and the applied link settings are 50 kbps, 99 kHz RBW, 14 dBm TX power, and 1% PER. The test site is a flat track of land with lawn. Table 1 summarizes these possible best outdoor range results together with the GPS coordinates.

During the measurements, the range number (in meters) is extracted from the Google map distance plot.

Table 1. Results







					GPS		Distance [m]		
					N	E			
					Base II	47.126000°	19.209133°	0.0	Base II
					Base III	47.158820°	19.174040°	0.0	Base III
Med. ILA (WES0031)					Max. direction: XZV 0°			1083.9	Base II
						GPS			
	1	14dBm	50kbps		N	E			
						47.134467°	19.202033°		
Chip (WES0032)					Max. direction: XZV 180°			998.2	Base II
						GPS			
	2	14dBm	50kbps		N	E			
						47.133800°	19.202600°		
SmI.Helic (WES0033)					Max. direction: XZV 270°			1188.3	Base II
						GPS			
	3	14dBm	50kbps		N	E			
						47.135283°	19.201350°		
Med.Helic (WES0034)					Max. direction: XZV 90°			1177.4	Base II
						GPS			
	4	14dBm	50kbps		N	E			
						47.135183°	19.201383°		
PIFA (WES0035)					Max. direction: XZV 0°			1189.0	Base II
						GPS			
	5	14dBm	50kbps		N	E			
						47.135283°	19.201333°		
PILA (WES0036)					Max. direction: XZV 0°			1289.9	Base II
						GPS			
	6	14dBm	50kbps		N	E			
						47.136050°	19.200617°		

Table 1. Results (continued)

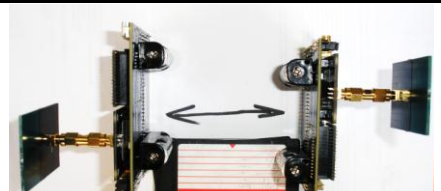
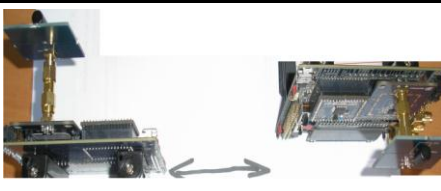
Meand (WES0037)			Max. direction: XYV 135°				1310.4	Base II
			GPS					
					N	E		
			7	14dBm	50kbps	47.136217°		
Sm.I. ILA(WES0038)			Max. direction: XZV 0°				548.6	Base II
			GPS					
					N	E		
			8	14dBm	50kbps	47.130283°		
BIFA (WES0039)			Max. direction: XZV 90°				973.4	Base II
			GPS					
					N	E		
			9	14dBm	50kbps	47.133633°		
Rference Monopl			V pol; Norm. direction				1158.3	Base II
			GPS					
					N	E		
			10	14dBm	50kbps	47.135050°		
						2151.0	Base III	

CONTACT INFORMATION

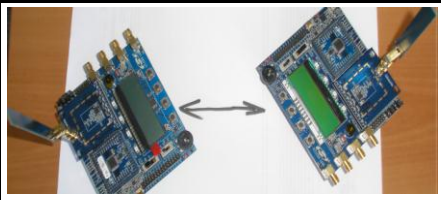
Silicon Laboratories Inc.

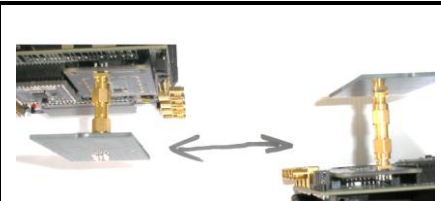
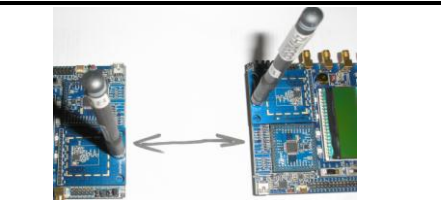
400 West Cesar Chavez
Austin, TX 78701
Tel: 1+(512) 416-8500
Fax: 1+(512) 416-9669
Toll Free: 1+(877) 444-3032

Please visit the Silicon Labs Technical Support web page:
<https://www.silabs.com/support/pages/contacttechnicalsupport.aspx>
and register to submit a technical support request.

Patent Notice

Silicon Labs invests in research and development to help our customers differentiate in the market with innovative low-power, small size, analog-intensive mixed-signal solutions. Silicon Labs' extensive patent portfolio is a testament to our unique approach and world-class engineering team.

The information in this document is believed to be accurate in all respects at the time of publication but is subject to change without notice. Silicon Laboratories assumes no responsibility for errors and omissions, and disclaims responsibility for any consequences resulting from the use of information included herein. Additionally, Silicon Laboratories assumes no responsibility for the functioning of undescribed features or parameters. Silicon Laboratories reserves the right to make changes without further notice. Silicon Laboratories makes no warranty, representation or guarantee regarding the suitability of its products for any particular purpose, nor does Silicon Laboratories assume any liability arising out of the application or use of any product or circuit, and specifically disclaims any and all liability, including without limitation consequential or incidental damages. Silicon Laboratories products are not designed, intended, or authorized for use in applications intended to support or sustain life, or for any other application in which the failure of the Silicon Laboratories product could create a situation where personal injury or death may occur. Should Buyer purchase or use Silicon Laboratories products for any such unintended or unauthorized application, Buyer shall indemnify and hold Silicon Laboratories harmless against all claims and damages.

Silicon Laboratories and Silicon Labs are trademarks of Silicon Laboratories Inc.
Other products or brandnames mentioned herein are trademarks or registered trademarks of their respective holders.



Стандарт Электрон Связь

Мы молодая и активно развивающаяся компания в области поставок электронных компонентов. Мы поставляем электронные компоненты отечественного и импортного производства напрямую от производителей и с крупнейших складов мира.

Благодаря сотрудничеству с мировыми поставщиками мы осуществляем комплексные и плановые поставки широчайшего спектра электронных компонентов.

Собственная эффективная логистика и склад в обеспечивает надежную поставку продукции в точно указанные сроки по всей России.

Мы осуществляем техническую поддержку нашим клиентам и предпродажную проверку качества продукции. На все поставляемые продукты мы предоставляем гарантию .

Осуществляем поставки продукции под контролем ВП МО РФ на предприятия военно-промышленного комплекса России , а также работаем в рамках 275 ФЗ с открытием отдельных счетов в уполномоченном банке. Система менеджмента качества компании соответствует требованиям ГОСТ ISO 9001.

Минимальные сроки поставки, гибкие цены, неограниченный ассортимент и индивидуальный подход к клиентам являются основой для выстраивания долгосрочного и эффективного сотрудничества с предприятиями радиоэлектронной промышленности, предприятиями ВПК и научно-исследовательскими институтами России.

С нами вы становитесь еще успешнее!

Наши контакты:

Телефон: +7 812 627 14 35

Электронная почта: sales@st-electron.ru

Адрес: 198099, Санкт-Петербург,
Промышленная ул, дом № 19, литера Н,
помещение 100-Н Офис 331