

## HIGH POWER SPDT SWITCH GaAs MMIC

### ■ GENERAL DESCRIPTION

The NJG1681MD7 is a GaAs SPDT switch MMIC suitable for LTE/UMTS/CDMA/GSM applications.

The NJG1681MD7 features very low insertion loss, high isolation and excellent linearity performance down to 1.8V control voltage at high frequency up to 6GHz. In addition, this switch is able to handle high power signals.

The NJG1681MD7 has ESD protection devices to achieve excellent ESD performances. No DC Blocking capacitors are required for all RF ports unless DC is biased externally. And the ultra small & ultra thin EQFN14-D7 package is adopted.

### ■ PACKAGE OUTLINE

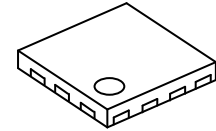

NJG1681MD7

### ■ APPLICATIONS

- LTE, UMTS, CDMA, GSM applications
- IEEE802.11p application
- Antenna switching, bands switching, post PA switching applications

### ■ FEATURES

- Low voltage logic control
  - Low voltage operation
  - Low distortion
  - P-0.1dB
  - Low insertion loss
  - Ultra small & ultra thin package
  - RoHS compliant and Halogen Free, MSL1
- $V_{CTL(H)}=1.8V$  typ.  
 $V_{DD}=2.7V$  typ.  
 IIP3=+73dBm typ. @f=829+849MHz,  $P_{IN}=24dBm$   
 IIP3=+71dBm typ. @f=1870+1910MHz,  $P_{IN}=24dBm$   
 2nd harmonics=-85dBc typ. @ f=0.9GHz,  $P_{IN}=35dBm$   
 3rd harmonics=-90dBc typ. @ f=0.9GHz,  $P_{IN}=35dBm$   
 +36dBm min.  
 0.18dB typ. @f=0.9GHz,  $P_{IN}=35dBm$   
 0.20dB typ. @f=1.9GHz,  $P_{IN}=33dBm$   
 0.23dB typ. @f=2.7GHz,  $P_{IN}=27dBm$   
 0.45dB typ. @f=6.0GHz,  $P_{IN}=27dBm$   
 EQFN14-D7 (Package size: 1.6 x 1.6 x 0.397mm.)

### ■ PIN CONFIGURATION

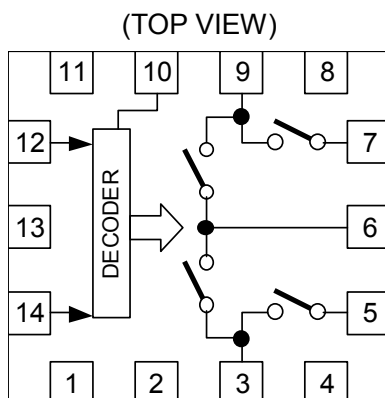

#### Pin connection

- |            |             |
|------------|-------------|
| 1. GND     | 8. GND      |
| 2. NC(GND) | 9. P1       |
| 3. P2      | 10. GND     |
| 4. GND     | 11. GND     |
| 5. GND     | 12. VDD     |
| 6. PC      | 13. NC(GND) |
| 7. GND     | 14. VCTL    |

Exposed PAD: GND

### ■ TRUTH TABLE

“H”= $V_{CTL(H)}$ , “L”= $V_{CTL(L)}$

VCTL	Path
H	PC-P1
L	PC-P2

NOTE: Please note that any information on this datasheet will be subject to change.

# NJG1681MD7

## ■ ABSOLUTE MAXIMUM RATINGS

( $T_a=+25^{\circ}\text{C}$ ,  $Z_s=Z_l=50\Omega$ )

PARAMETER	SYMBOL	CONDITIONS	RATINGS	UNITS
RF Input Power	$P_{IN}$	$V_{DD}=2.7\text{V}$	37	dBm
Supply Voltage	$V_{DD}$		5.0	V
Control Voltage	$V_{CTL}$		5.0	V
Power Dissipation	$P_D$	Four-layer FR4 PCB with through-hole (74.2x74.2mm), $T_j=150^{\circ}\text{C}$	1300	mW
Operating Temp.	$T_{opr}$		-40 to +105	$^{\circ}\text{C}$
Storage Temp.	$T_{stg}$		-55 to +150	$^{\circ}\text{C}$

## ■ ELECTRICAL CHARACTERISTICS 1 (DC)

(General conditions:  $T_a=+25^{\circ}\text{C}$ ,  $V_{DD}=2.7\text{V}$ ,  $V_{CTL(L)}=0\text{V}$ ,  $V_{CTL(H)}=1.8\text{V}$ )

PARAMETERS	SYMBOL	CONDITIONS	MIN	TYP	MAX	UNITS
Supply Voltage	$V_{DD}$		2.375	2.7	5.0	V
Operating Current	$I_{DD}$	No RF input, $V_{DD}=2.7\text{V}$	-	95	180	$\mu\text{A}$
Control Voltage (LOW)	$V_{CTL(L)}$		0	-	0.45	V
Control Voltage (HIGH)	$V_{CTL(H)}$		1.35	1.8	5.0	V
Control Current	$I_{CTL}$	$V_{CTL(H)}=1.8\text{V}$	-	4	10	$\mu\text{A}$

## ■ ELECTRICAL CHARACTERISTICS 2 (RF)

(General conditions:  $T_a=+25^{\circ}\text{C}$ ,  $Z_s=Z_l=50\Omega$ ,  $V_{DD}=2.7\text{V}$ ,  $V_{CTL(L)}=0\text{V}$ ,  $V_{CTL(H)}=1.8\text{V}$ )

PARAMETERS	SYMBOL	CONDITIONS	MIN	TYP	MAX	UNITS
Insertion Loss 1	LOSS1	f=0.9GHz, $P_{IN}=35\text{dBm}$	-	0.18	0.33	dB
Insertion Loss 2	LOSS2	f=1.9GHz, $P_{IN}=33\text{dBm}$	-	0.20	0.40	dB
Insertion Loss 3	LOSS3	f=2.7GHz, $P_{IN}=27\text{dBm}$	-	0.23	0.43	dB
Insertion Loss 4	LOSS4	f=6.0GHz, $P_{IN}=27\text{dBm}$	-	0.45	0.65	dB
Isolation 1	ISL1	f=0.9GHz, $P_{IN}=35\text{dBm}$	40	45	-	dB
Isolation 2	ISL2	f=1.9GHz, $P_{IN}=33\text{dBm}$	30	35	-	dB
Isolation 3	ISL3	f=2.7GHz, $P_{IN}=27\text{dBm}$	25	30	-	dB
Isolation 4	ISL4	f=6.0GHz, $P_{IN}=27\text{dBm}$	16.5	20	-	dB
Input Power at 0.1dB Compression Point	$P_{-0.1\text{dB}}$	f=0.9GHz, f=1.9GHz, f=2.7GHz, f=6.0GHz	+36	-	-	dBm
2nd Harmonics 1	2fo(1)	f=0.9GHz, $P_{IN}=35\text{dBm}$	-	-85	-70	dBc
2nd Harmonics 2	2fo(2)	f=1.9GHz, $P_{IN}=33\text{dBm}$	-	-90	-70	dBc
2nd Harmonics 3	2fo(3)	f=2.7GHz, $P_{IN}=27\text{dBm}$	-	-90	-70	dBc
3rd Harmonics 1	3fo(1)	f=0.9GHz, $P_{IN}=35\text{dBm}$	-	-90	-70	dBc
3rd Harmonics 2	3fo(2)	f=1.9GHz, $P_{IN}=33\text{dBm}$	-	-80	-70	dBc
3rd Harmonics 3	3fo(3)	f=2.7GHz, $P_{IN}=27\text{dBm}$	-	-90	-70	dBc
Input 3 <sup>rd</sup> order intercept point1	IIP3(1)	f=829+849MHz, $P_{IN}=24\text{dBm}$ each	+65	+73	-	dBm
Input 3 <sup>rd</sup> order intercept point2	IIP3(2)	f=1870+1910MHz, $P_{IN}=24\text{dBm}$ each	+65	+71	-	dBm
VSWR 1	VSWR 1	on-state ports, f=2.7GHz	-	1.1	1.4	
VSWR 2	VSWR 2	on-state ports, f=6.0GHz	-	1.1	1.4	
Switching time	$T_{SW}$	50% $V_{CTL}$ to 10/90% RF	-	1	5	$\mu\text{s}$

\*1: IIP3 are defined by the following equations.

$$IIP3=(3 \times P_{out-IM3})/2+LOSS$$

# NJG1681MD7

## ■ TERMINAL INFORMATION

No.	SYMBOL	DESCRIPTION
1	GND	Ground terminal. Please connect this terminal with ground plane as close as possible for excellent RF performance.
2	NC(GND)	No connected terminal. Please connect this terminal with ground plane as close as possible for excellent RF performance.
3	P2	RF transmitting/receiving port. No DC blocking capacitor is required for this port unless DC is biased externally.
4	GND	Ground terminal. Please connect this terminal with ground plane as close as possible for excellent RF performance.
5	GND	Ground terminal. Please connect this terminal with ground plane as close as possible for excellent RF performance.
6	PC	RF transmitting/receiving port. No DC blocking capacitor is required for this port unless DC is biased externally. Please connect an inductor with GND terminal for ESD protection.
7	GND	Ground terminal. Please connect this terminal with ground plane as close as possible for excellent RF performance.
8	GND	Ground terminal. Please connect this terminal with ground plane as close as possible for excellent RF performance.
9	P1	RF transmitting/receiving port. No DC blocking capacitor is required for this port unless DC is biased externally.
10	GND	Ground terminal. Please connect this terminal with ground plane as close as possible for excellent RF performance.
11	GND	Ground terminal. Please connect this terminal with ground plane as close as possible for excellent RF performance.
12	VDD	Positive voltage supply terminal. The positive voltage (+2.375~+5V) has to be supplied. Please connect a bypass capacitor with GND terminal for excellent RF performance.
13	NC(GND)	No connected terminal. Please connect this terminal with ground plane as close as possible for excellent RF performance.
14	VCTL	Control signal input terminal. This terminal is set to High-Level (+1.35~+5.0V) or Low-Level (0~+0.45V).
Exposed Pad	GND	Ground terminal.

## ■ ELECTRICAL CHARACTERISTICS (With application circuit)

**Loss, ISL vs Frequency**

(PC-P1 ON,  $V_{DD}=2.7V$ ,  $V_{CTL}=1.8V$ )  
(Losses of external circuits are excluded)

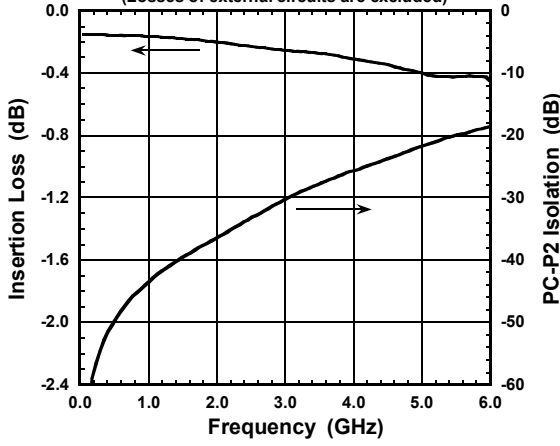

**Loss, ISL vs Frequency**

(PC-P2 ON,  $V_{DD}=2.7V$ ,  $V_{CTL}=0V$ )  
(Losses of external circuits are excluded)

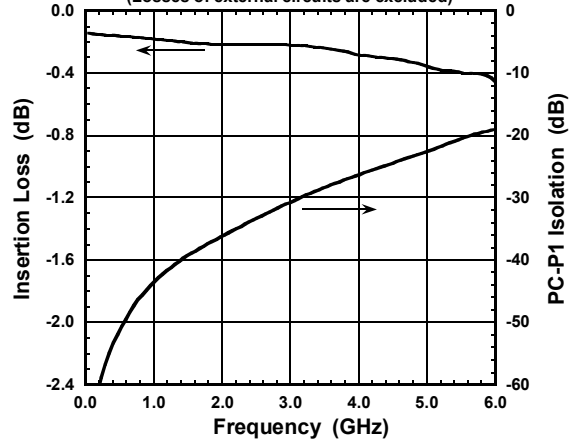

**VSWR vs Frequency**

(PC-P1 ON,  $V_{DD}=2.7V$ ,  $V_{CTL}=1.8V$ )

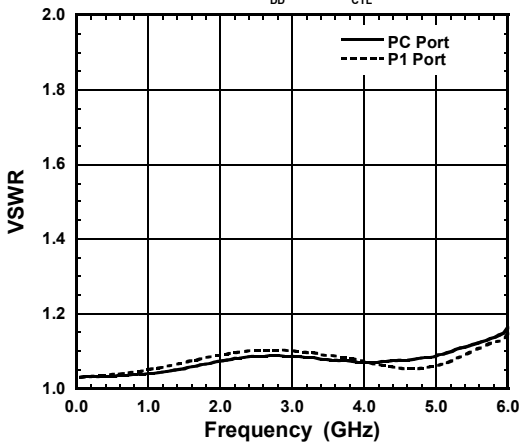

**VSWR vs Frequency**

(PC-P2 ON,  $V_{DD}=2.7V$ ,  $V_{CTL}=0V$ )

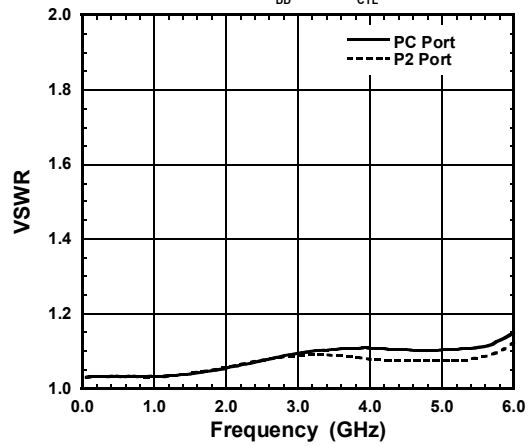

**IDD vs. VDD**

(No RF input, PC-P1 ON,  $V_{CTL}=1.8V$ )

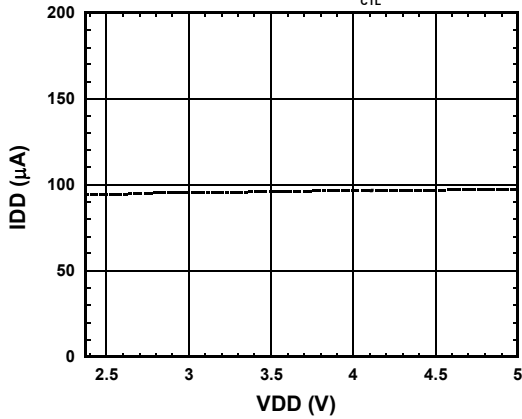

**Control Current vs. VCTL**

(No RF input, PC-P1 ON,  $V_{DD}=2.7V$ )

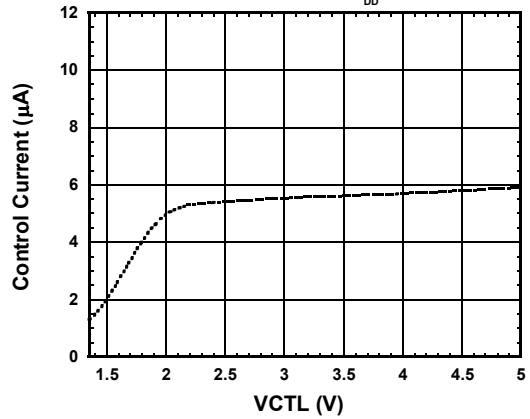

# NJG1681MD7

## ■ ELECTRICAL CHARACTERISTICS (With application circuit)

**Output Power,  $I_{DD}$  vs Input Power**

( $f=0.9\text{GHz}$ , PC-P1 ON,  $V_{CT1}=1.8\text{V}$ )  
(Losses of external circuits are excluded)

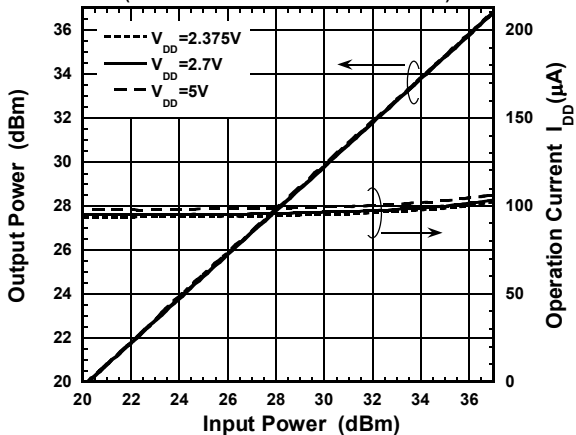

**Output Power,  $I_{DD}$  vs Input Power**

( $f=1.9\text{GHz}$ , PC-P1 ON,  $V_{CT1}=1.8\text{V}$ )  
(Losses of external circuits are excluded)

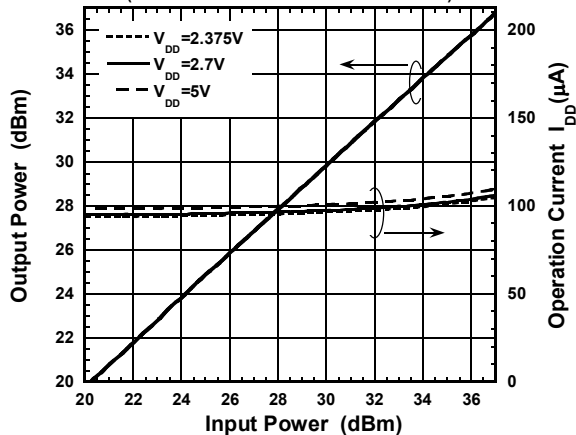

**Output Power,  $I_{DD}$  vs Input Power**

( $f=2.7\text{GHz}$ , PC-P1 ON,  $V_{CT1}=1.8\text{V}$ )  
(Losses of external circuits are excluded)

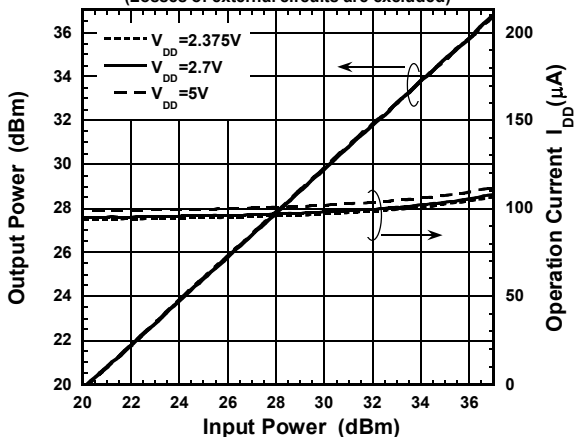

**Output Power,  $I_{DD}$  vs Input Power**

( $f=6.0\text{GHz}$ , PC-P1 ON,  $V_{CT1}=1.8\text{V}$ )  
(Losses of external circuits are excluded)

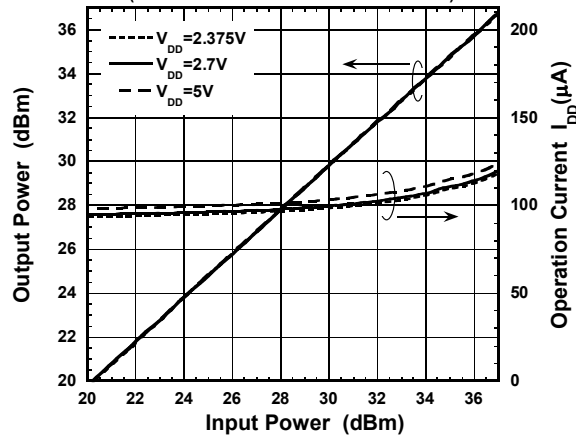

## ■ ELECTRICAL CHARACTERISTICS (With application circuit)

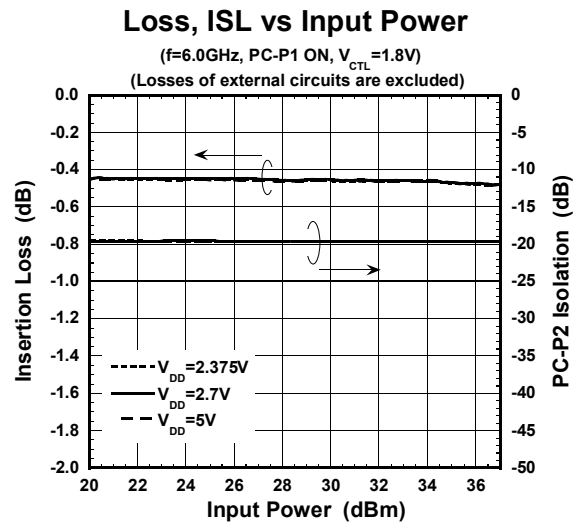
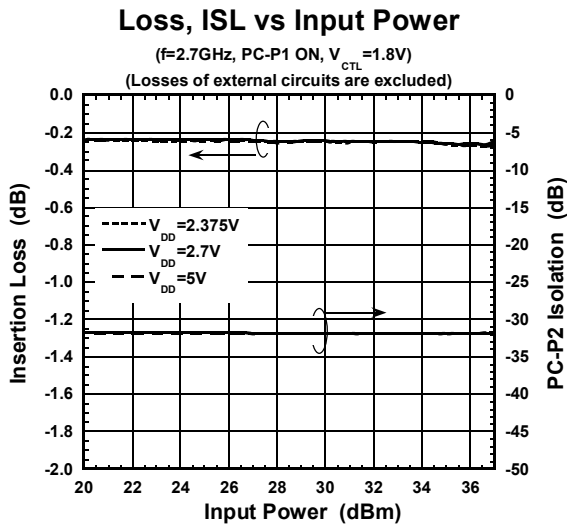
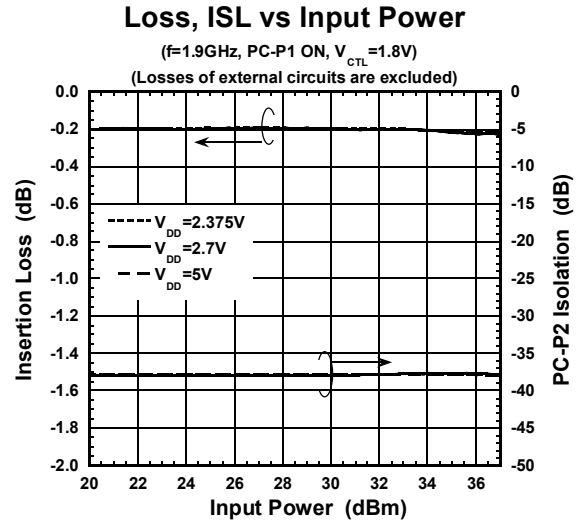
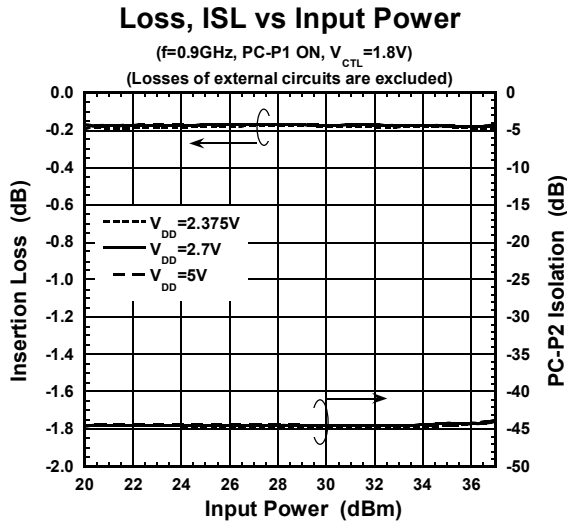

# NJG1681MD7

## ■ ELECTRICAL CHARACTERISTICS (With application circuit)

**Loss, ISL vs Ambient Temperature**

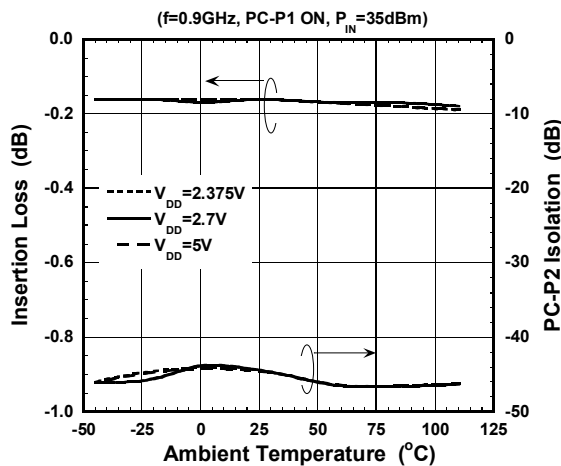

**Loss, ISL vs Ambient Temperature**

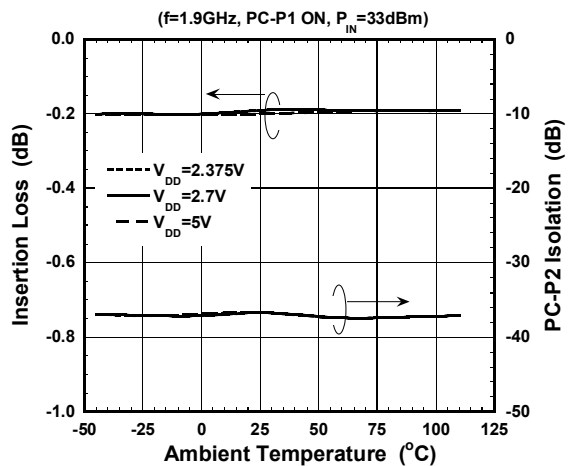

**Loss, ISL vs Ambient Temperature**

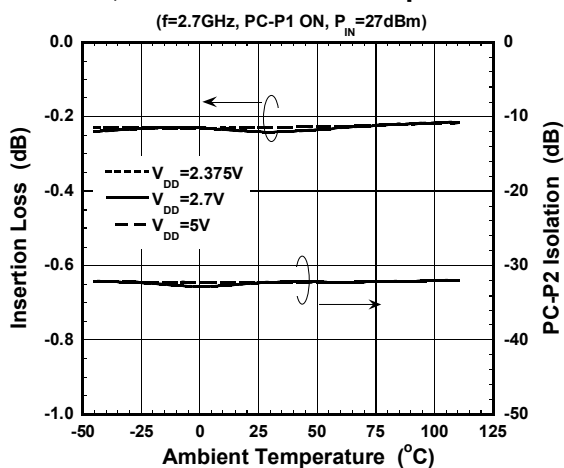

**Loss, ISL vs Ambient Temperature**

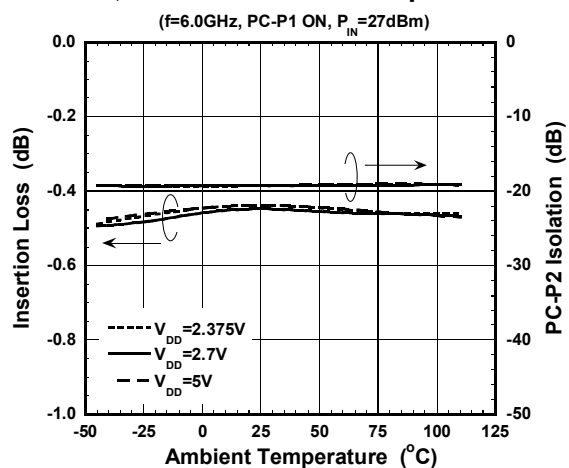

**DC Current vs Ambient Temperature**

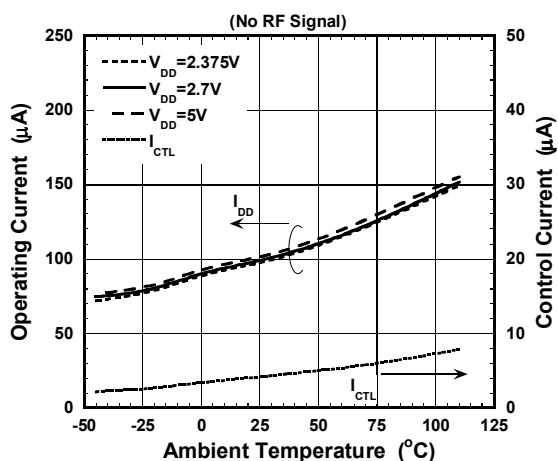

**Switching Time vs Ambient Temperature**

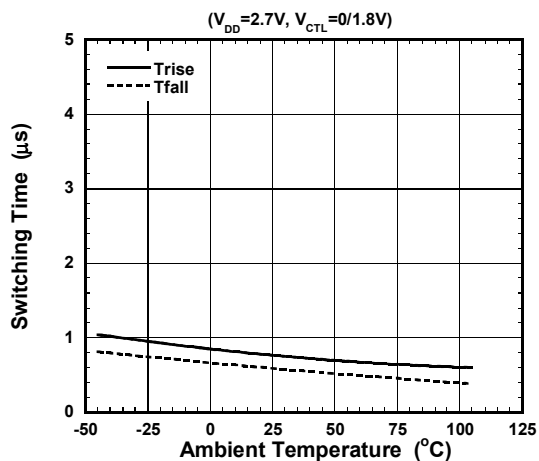



## APPLICATION CIRCUIT

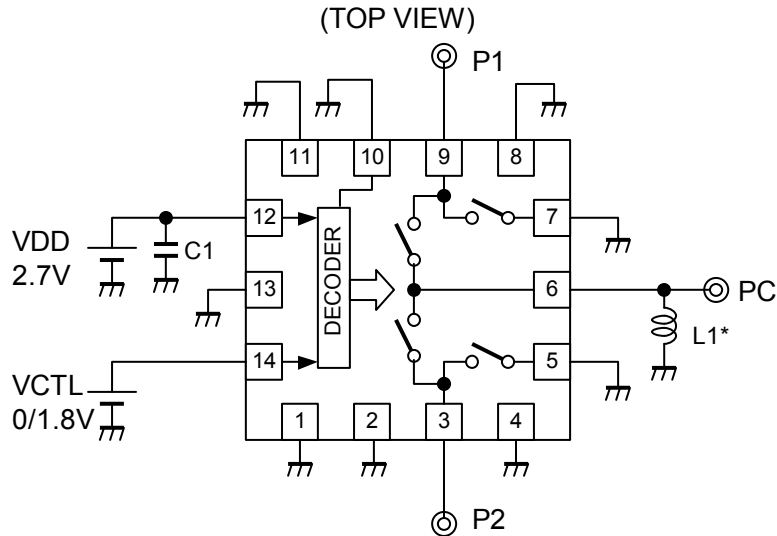

Note: No DC blocking capacitors are required on all RF ports, unless DC is biased externally.

- \* The Inductor L1 is required for enhancing ESD protection level.  
The inductor L1 is recommended in order to keep the DC bias level of each RF port at 0 V level tightly.

## PARTS LIST

No.	Parameters	Note
C1	1000pF	MURATA (GRM15)
L1	68nH	TAIYO-YUDEN (HK1005)

## PCB LAYOUT

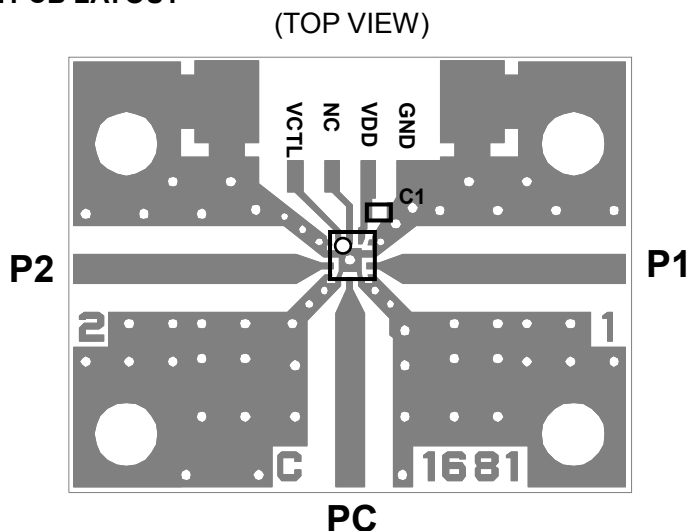

PCB SIZE: 19.4 x 15.0 mm  
PCB: FR-4, t=0.5mm  
Capacitor size: 1005  
MICROSTRIP LINE WIDTH: 0.98mm

Losses of PCB and connectors, Ta=+25°C



Frequency (GHz)	Loss (dB)
0.9	0.09
1.9	0.18
2.7	0.26
6.0	0.48

## PRECAUTIONS

- [1] No DC blocking capacitors are required at each RF port normally. When the other device is biased at certain voltage and connected to the NJG1681MD7, a DC block capacitor is required between the device and the switch IC. This is because the each RF port of NJG1681MD7 is biased at 0 V (GND).
- [2] For avoiding the degradation of RF performance, the bypass capacitor (C1) should be placed as close as possible to VDD terminal
- [3] For good RF performance, all GND terminals are must be connected to PCB ground plane of substrate, and through - holes for GND should be placed the IC near.

# NJG1681MD7

## RECOMMENDED FOOTPRINT PATTERN (EQFN14-D7 PACKAGE Reference)

-  :Land
-  :Mask (Open area) \*Metal mask thickness : 100μm
-  :Resist(Open area)

PKG: 1.6mm x 1.6mm  
Pin pitch: 0.4mm

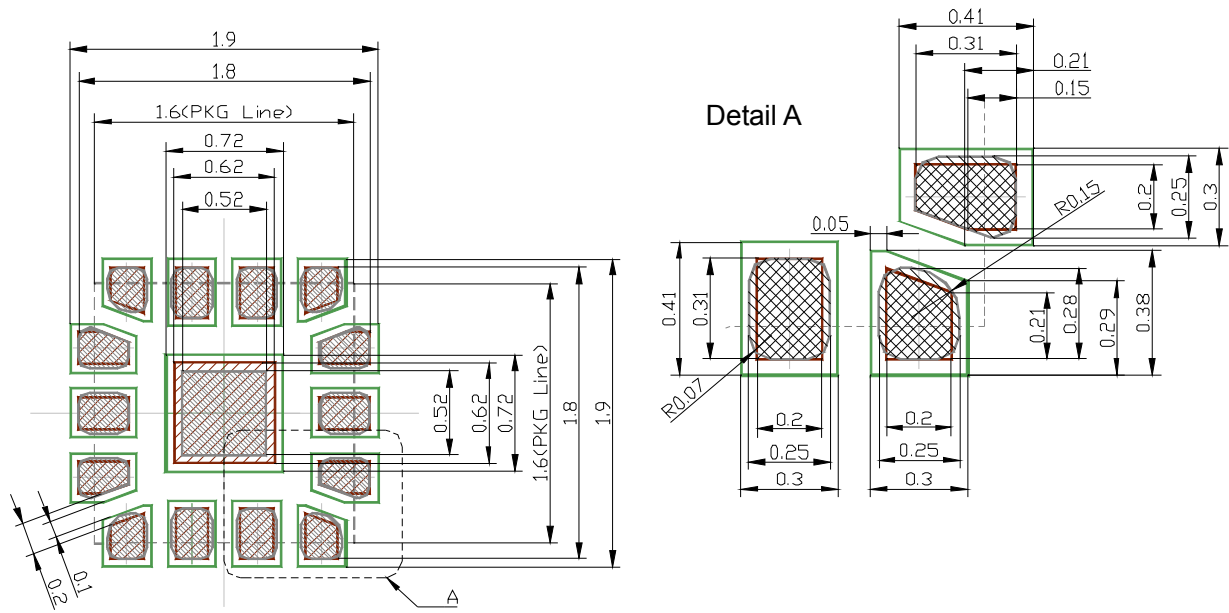

## ■ PACKAGE OUTLINE (EQFN14-D7)

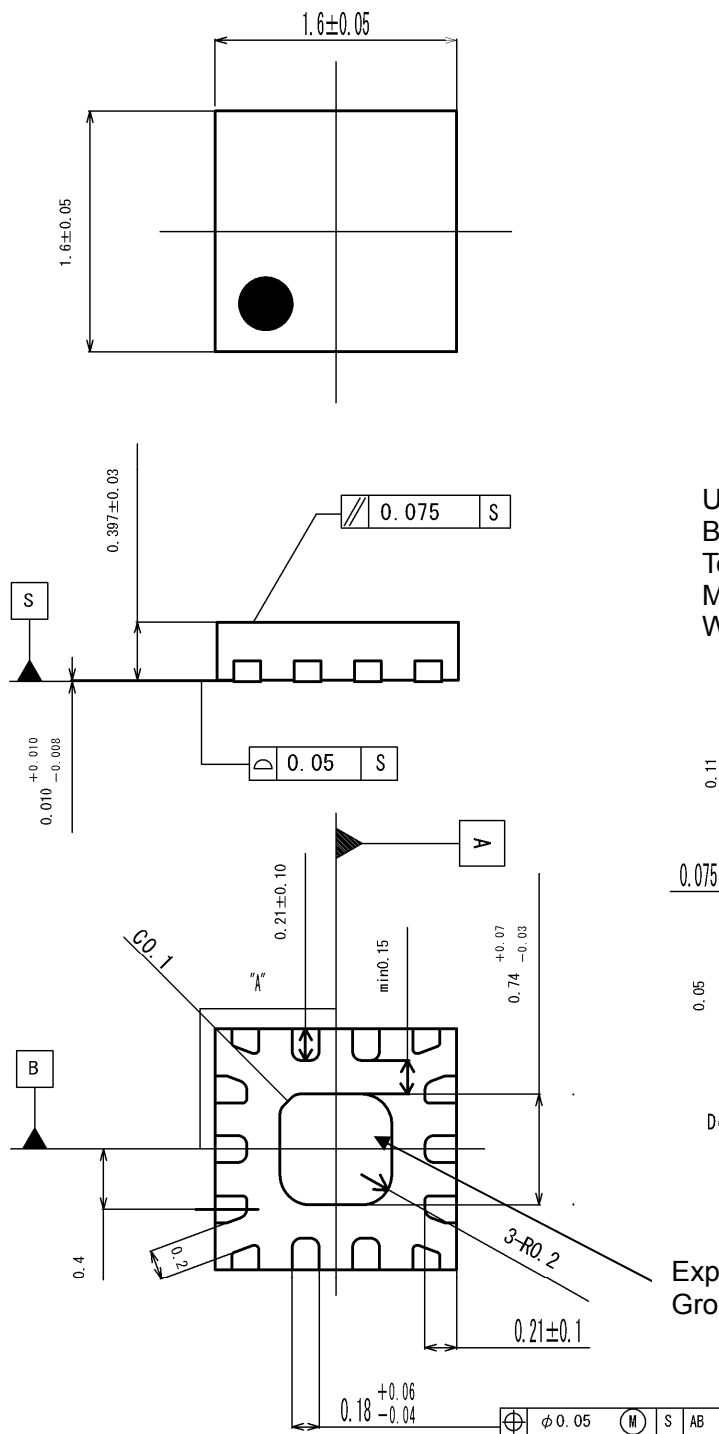

Units : mm  
 Board : Cu  
 Terminal treat : SnBi  
 Molding material : Epoxy resin  
 Weight : 3.4mg

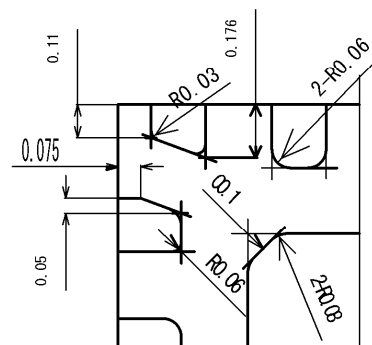

Details of "A" part (× 2)

Exposed PAD  
 Ground connection is required.

### Cautions on using this product

This product contains Gallium-Arsenide (GaAs) which is a harmful material.

- Do NOT eat or put into mouth.
- Do NOT dispose in fire or break up this product.
- Do NOT chemically make gas or powder with this product.
- To waste this product, please obey the relating law of your country.

### [CAUTION]

The specifications on this databook are only given for information, without any guarantee as regards either mistakes or omissions. The application circuits in this databook are described only to show representative usages of the product and not intended for the guarantee or permission of any right including the industrial rights.

This product may be damaged with electric static discharge (ESD) or spike voltage. Please handle with care to avoid these damages.

# Mouser Electronics

Authorized Distributor

Click to View Pricing, Inventory, Delivery & Lifecycle Information:

[NJR:](#)

[NJG1681MD7-TE1](#)



## Стандарт Электрон Связь

Мы молодая и активно развивающаяся компания в области поставок электронных компонентов. Мы поставляем электронные компоненты отечественного и импортного производства напрямую от производителей и с крупнейших складов мира.

Благодаря сотрудничеству с мировыми поставщиками мы осуществляем комплексные и плановые поставки широчайшего спектра электронных компонентов.

Собственная эффективная логистика и склад в обеспечивает надежную поставку продукции в точно указанные сроки по всей России.

Мы осуществляем техническую поддержку нашим клиентам и предпродажную проверку качества продукции. На все поставляемые продукты мы предоставляем гарантию .

Осуществляем поставки продукции под контролем ВП МО РФ на предприятия военно-промышленного комплекса России , а также работаем в рамках 275 ФЗ с открытием отдельных счетов в уполномоченном банке. Система менеджмента качества компании соответствует требованиям ГОСТ ISO 9001.

Минимальные сроки поставки, гибкие цены, неограниченный ассортимент и индивидуальный подход к клиентам являются основой для выстраивания долгосрочного и эффективного сотрудничества с предприятиями радиоэлектронной промышленности, предприятиями ВПК и научно-исследовательскими институтами России.

С нами вы становитесь еще успешнее!

### Наши контакты:

**Телефон:** +7 812 627 14 35

**Электронная почта:** [sales@st-electron.ru](mailto:sales@st-electron.ru)

**Адрес:** 198099, Санкт-Петербург,  
Промышленная ул, дом № 19, литера Н,  
помещение 100-Н Офис 331