

Product Summary (@ T_A = +25°C)

V _{RRM} (V)	I _O (A)	V _{F max} (V) @ +25°C	I _{R max} (mA) @ +25°C
50	15	0.52	0.5

Description

Packaged in the compact thermally efficient POWERDI5 package, the SBR15U50SP5 provides very low V_F and provides excellent reverse leakage stability at high temperatures. It is ideal for use as a rectification, freewheeling or polarity protection diode:

Applications

- DC/DC Converters
- AC/DC Adaptors

Features and Benefits

- Low forward voltage drop (V_F) helps – minimizes power losses
- Excellent stability at higher temperatures
- Thermally efficient package for cooler running applications
- Less than 1.1mm package profile ideal for thin applications
- **Lead-Free Finish; RoHS Compliant (Notes 1 & 2)**
- **Halogen and Antimony Free. "Green" Device (Note 3)**

Mechanical Data

- Case: POWERDI5
- Case Material: Molded Plastic, "Green" Molding compound. UL Flammability Classification Rating 94V-0
- Moisture Sensitivity: Level 1 per J-STD-020
- Terminal Connections: See Diagram Below
- Weight: 0.093 grams (approximate)

POWERDI5

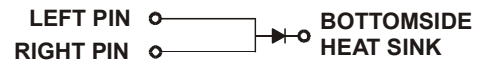
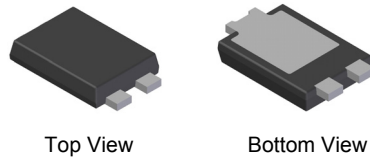

Note: Pins Left & Right must be electrically connected at the printed circuit board.

Ordering Information (Note 4)

Part Number	Case	Packaging
SBR15U50SP5-13	POWERDI5	5000/Tape & Reel

- Notes:
1. EU Directive 2002/95/EC (RoHS) & 2011/65/EU (RoHS 2) compliant. All applicable RoHS exemptions applied.
 2. See http://www.diodes.com/quality/lead_free.html for more information about Diodes Incorporated's definitions of Halogen- and Antimony-free, "Green" and Lead-free.
 3. Halogen- and Antimony-free "Green" products are defined as those which contain <900ppm bromine, <900ppm chlorine (<1500ppm total Br + Cl) and <1000ppm antimony compounds.
 4. For packaging details, go to our website at <http://www.diodes.com/products/packages.html>.

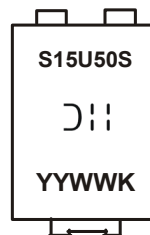
Marking Information

S15U50S = Product Type Marking Code
 YYWW = Date Code Marking
 YY = Last Two Digits of Year (ex: 12 = 2012)
 WW = Week code (01 - 53)
 K = Factory Designator

Maximum Ratings (@ $T_A = +25^\circ\text{C}$, unless otherwise specified.)

Characteristic	Symbol	Value	Unit
Peak Repetitive Reverse Voltage Working Peak Reverse Voltage DC blocking Voltage	V_{RRM}	50	V
Average Rectified Output Current	I_o	15	A
Non-Repetitive Peak Forward Surge Current 8.3ms	I_{FSM}	256	A

Thermal Characteristics

Characteristic	Symbol	Value	Unit
Typical Thermal Resistance (Note 5)	$R_{\theta JA}$	97	$^\circ\text{C/W}$
Typical Thermal Resistance (Note 6)	$R_{\theta JA}$	39	$^\circ\text{C/W}$
Typical Thermal Resistance (Note 7)	$R_{\theta JM}$	4	$^\circ\text{C/W}$
Operating and Storage Temperature Range	T_J, T_{STG}	-65 to +150	$^\circ\text{C}$

Electrical Characteristics (@ $T_A = +25^\circ\text{C}$, unless otherwise specified.)

Characteristic	Symbol	Min	Typ	Max	Unit	Test Condition
Forward Voltage Drop	V_F	—	—	0.48	V	$I_F = 10\text{A}, T_J = +25^\circ\text{C}$
		—	0.33	—		$I_F = 10\text{A}, T_J = +125^\circ\text{C}$
		—	0.44	0.52		$I_F = 15\text{A}, T_J = +25^\circ\text{C}$
		—	0.40	—		$I_F = 15\text{A}, T_J = +125^\circ\text{C}$
Leakage Current (Note 8)	I_R	—	—	0.5	mA	$V_R = 50\text{V}, T_J = +25^\circ\text{C}$ $V_R = 50\text{V}, T_J = +125^\circ\text{C}$
Junction Capacitance	C_J	—	400	—	pF	$V_R = 25\text{V}, T_J = +25^\circ\text{C}$

- Notes:
5. FR-4 PCB, 2oz. Copper, minimum recommended pad layout per <http://www.diodes.com>.
 6. FR-4 PCB, 2oz. Copper. Cathode pad dimensions 18.8mm x 14.4mm. Anode pad dimensions 5.6mm x 14.4mm.
 7. Junction to Mount (Cathode Terminal)
 8. Short duration pulse test used to minimize self-heating effect.

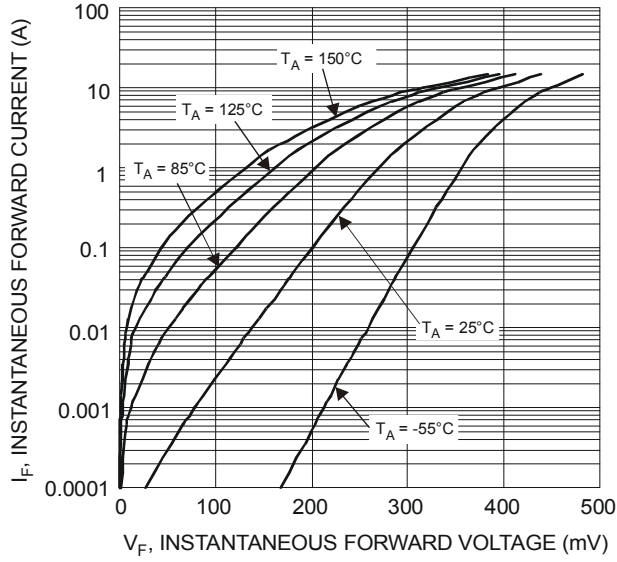

Figure 1 Typical Forward Characteristics

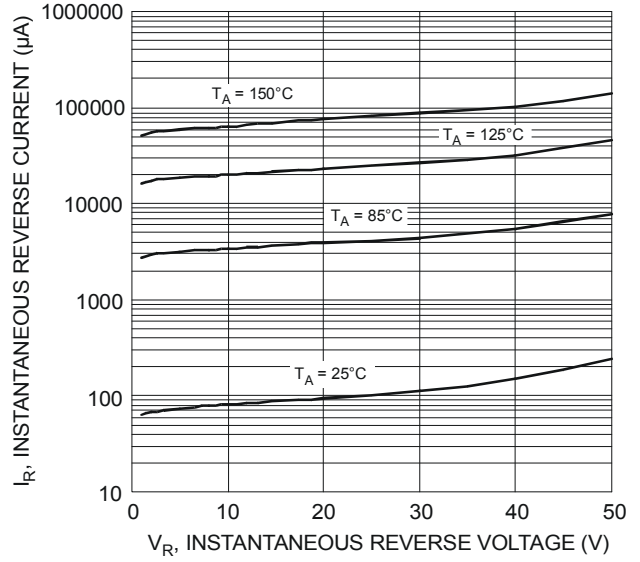

Figure 2 Typical Reverse Characteristics

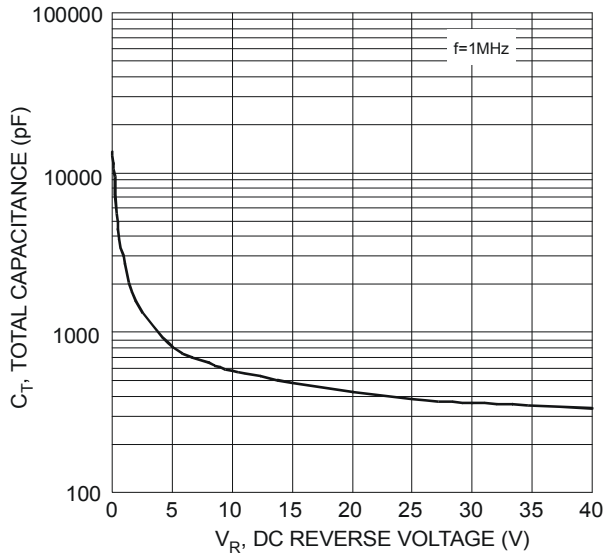

Figure 3 Total Capacitance vs. Reverse Voltage

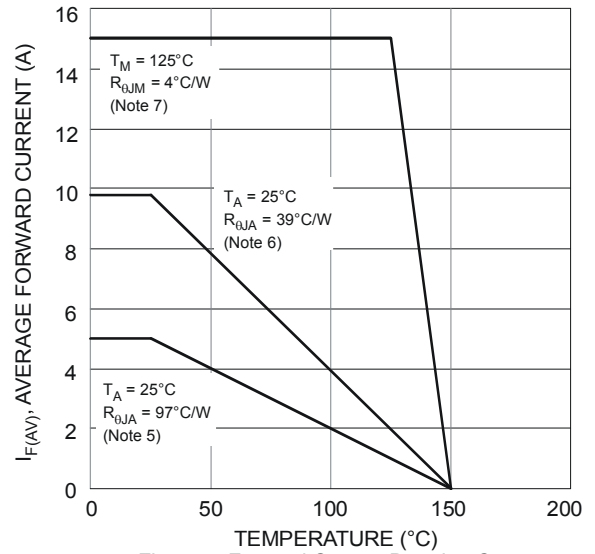

Figure 4 Forward Current Derating Curve

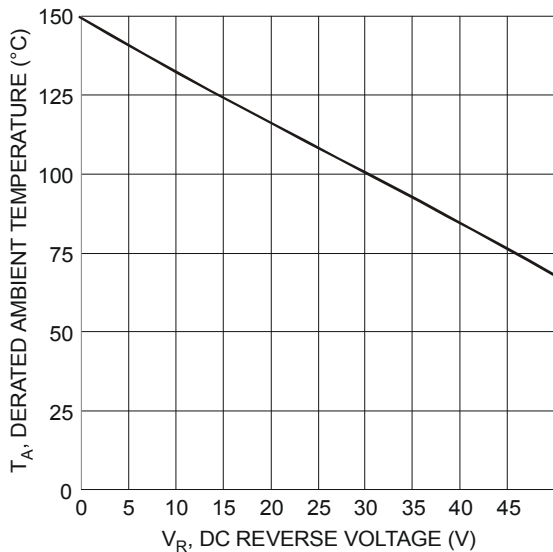
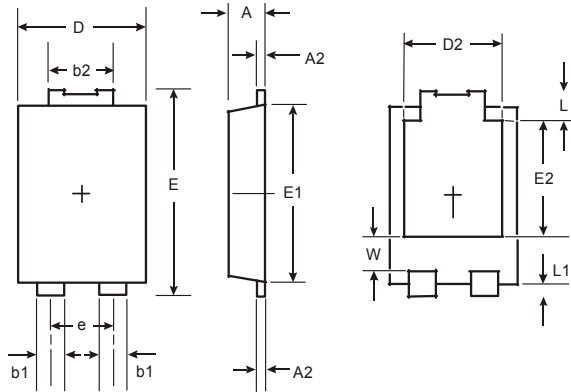

Figure 5 Operating Temperature Derating

Package Outline Dimensions

Please see AP02002 at <http://www.diodes.com/datasheets/ap02002.pdf> for latest version.



POWERDI [®] 5		
Dim	Min	Max
A	1.05	1.15
A2	0.33	0.43
b1	0.80	0.99
b2	1.70	1.88
D	3.90	4.05
D2	3.054 Typ	
E	6.40	6.60
E	1.84 Typ	
E1	5.30	5.45
E2	3.549 Typ	
L	0.75	0.95
L1	0.50	0.65
W	1.10	1.41
All Dimensions in mm		

Suggested Pad Layout

Please see AP02001 at <http://www.diodes.com/datasheets/ap02001.pdf> for the latest version.

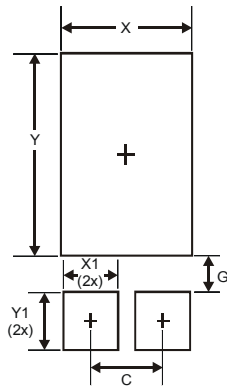

Dimensions	Value (in mm)
C	1.840
G	0.852
X	3.360
X1	1.390
Y	4.860
Y1	1.400

IMPORTANT NOTICE

DIODES INCORPORATED MAKES NO WARRANTY OF ANY KIND, EXPRESS OR IMPLIED, WITH REGARDS TO THIS DOCUMENT, INCLUDING, BUT NOT LIMITED TO, THE IMPLIED WARRANTIES OF MERCHANTABILITY AND FITNESS FOR A PARTICULAR PURPOSE (AND THEIR EQUIVALENTS UNDER THE LAWS OF ANY JURISDICTION).

Diodes Incorporated and its subsidiaries reserve the right to make modifications, enhancements, improvements, corrections or other changes without further notice to this document and any product described herein. Diodes Incorporated does not assume any liability arising out of the application or use of this document or any product described herein; neither does Diodes Incorporated convey any license under its patent or trademark rights, nor the rights of others. Any Customer or user of this document or products described herein in such applications shall assume all risks of such use and will agree to hold Diodes Incorporated and all the companies whose products are represented on Diodes Incorporated website, harmless against all damages.

Diodes Incorporated does not warrant or accept any liability whatsoever in respect of any products purchased through unauthorized sales channel. Should Customers purchase or use Diodes Incorporated products for any unintended or unauthorized application, Customers shall indemnify and hold Diodes Incorporated and its representatives harmless against all claims, damages, expenses, and attorney fees arising out of, directly or indirectly, any claim of personal injury or death associated with such unintended or unauthorized application.

Products described herein may be covered by one or more United States, international or foreign patents pending. Product names and markings noted herein may also be covered by one or more United States, international or foreign trademarks.

This document is written in English but may be translated into multiple languages for reference. Only the English version of this document is the final and determinative format released by Diodes Incorporated.

LIFE SUPPORT

Diodes Incorporated products are specifically not authorized for use as critical components in life support devices or systems without the express written approval of the Chief Executive Officer of Diodes Incorporated. As used herein:

A. Life support devices or systems are devices or systems which:

1. are intended to implant into the body, or
2. support or sustain life and whose failure to perform when properly used in accordance with instructions for use provided in the labeling can be reasonably expected to result in significant injury to the user.

B. A critical component is any component in a life support device or system whose failure to perform can be reasonably expected to cause the failure of the life support device or to affect its safety or effectiveness.

Customers represent that they have all necessary expertise in the safety and regulatory ramifications of their life support devices or systems, and acknowledge and agree that they are solely responsible for all legal, regulatory and safety-related requirements concerning their products and any use of Diodes Incorporated products in such safety-critical, life support devices or systems, notwithstanding any devices- or systems-related information or support that may be provided by Diodes Incorporated. Further, Customers must fully indemnify Diodes Incorporated and its representatives against any damages arising out of the use of Diodes Incorporated products in such safety-critical, life support devices or systems.

Copyright © 2013, Diodes Incorporated

www.diodes.com



Стандарт Электрон Связь

Мы молодая и активно развивающаяся компания в области поставок электронных компонентов. Мы поставляем электронные компоненты отечественного и импортного производства напрямую от производителей и с крупнейших складов мира.

Благодаря сотрудничеству с мировыми поставщиками мы осуществляем комплексные и плановые поставки широчайшего спектра электронных компонентов.

Собственная эффективная логистика и склад в обеспечивает надежную поставку продукции в точно указанные сроки по всей России.

Мы осуществляем техническую поддержку нашим клиентам и предпродажную проверку качества продукции. На все поставляемые продукты мы предоставляем гарантию .

Осуществляем поставки продукции под контролем ВП МО РФ на предприятия военно-промышленного комплекса России , а также работаем в рамках 275 ФЗ с открытием отдельных счетов в уполномоченном банке. Система менеджмента качества компании соответствует требованиям ГОСТ ISO 9001.

Минимальные сроки поставки, гибкие цены, неограниченный ассортимент и индивидуальный подход к клиентам являются основой для выстраивания долгосрочного и эффективного сотрудничества с предприятиями радиоэлектронной промышленности, предприятиями ВПК и научно-исследовательскими институтами России.

С нами вы становитесь еще успешнее!

Наши контакты:

Телефон: +7 812 627 14 35

Электронная почта: sales@st-electron.ru

Адрес: 198099, Санкт-Петербург,
Промышленная ул, дом № 19, литера Н,
помещение 100-Н Офис 331