



## PN2907A

## PNP SILICON TRANSISTOR

### PNP GENERAL PURPOSE AMPLIFIER

#### DESCRIPTION

This UTC **PN2907A** is designed for use as a general purpose amplifier and switch requiring collector currents to 500 mA.

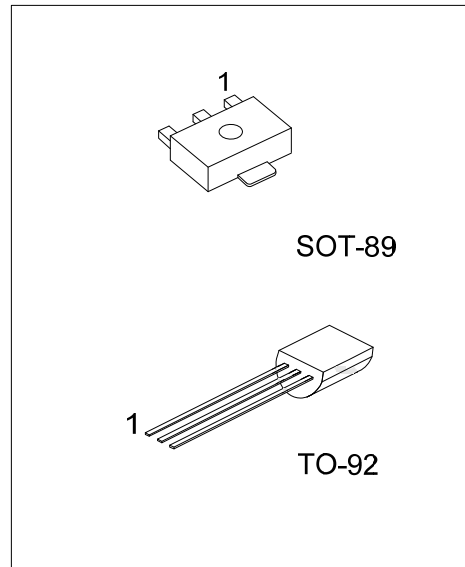

#### ORDERING INFORMATION

Ordering Number			Package	Pin Assignment			Packing
Normal	Lead Free Plating	Halogen Free		1	2	3	
PN2907A-AB3-R	PN2907AL-AB3-R	PN2907AG-AB3-R	SOT-89	B	C	E	Tape Reel
PN2907A-T92-B	PN2907AL-T92-B	PN2907AG-T92-B	TO-92	E	B	C	Tape Box
PN2907A-T92-K	PN2907AL-T92-K	PN2907AG-T92-K	TO-92	E	B	C	Bulk

<p>PN2907AL-AB3-R</p> <p>(1) Packing Type</p> <p>(2) Package Type</p> <p>(3) Lead Plating</p>	<p>(1) B: Tape Box, K: Bulk, R: Tape Reel</p> <p>(2) AB3: SOT-89, T92: TO-92</p> <p>(3) G: Halogen Free, L: Lead Free Plating, Blank: Pb/Sn</p>
---	---

■ ABSOLUTE MAXIMUM RATINGS (Ta=25°C, unless otherwise specified.)

PARAMETER	SYMBOL	RATINGS	UNIT
Collector-Emitter Voltage	V <sub>CEO</sub>	-60	V
Collector-Base Voltage	V <sub>CBO</sub>	-60	V
Emitter-Base Voltage	V <sub>EBO</sub>	-5	V
Collector Current-Continuous	I <sub>C</sub>	-800	mA
Power Dissipation	SOT-89	350	mW
	TO-92	625	mW
Junction Temperature	T <sub>J</sub>	+150	°C
Storage Temperature	T <sub>STG</sub>	-40 ~ +150	°C

Note: 1. These are steady state limits. The factory should be consulted on applications involving pulsed or low duty cycle operations.

2. Absolute maximum ratings are those values beyond which the device could be permanently damaged. Absolute maximum ratings are stress ratings only and functional device operation is not implied.

■ THERMAL DATA

PARAMETER	SYMBOL	RATINGS	UNIT
Thermal resistance, junction to Ambient	SOT-89	104	°C/W
	TO-92	200	°C/W

■ ELECTRICAL CHARACTERISTICS (Ta=25°C, unless otherwise specified.)

PARAMETER	SYMBOL	TEST CONDITIONS	MIN	TYP	MAX	UNIT
<b>OFF CHARACTERISTICS</b>						
Collector-Emitter Breakdown Voltage	BV <sub>CEO</sub>	I <sub>C</sub> =-10mA, I <sub>B</sub> =0	-60			V
Collector-Base Breakdown Voltage	BV <sub>CBO</sub>	I <sub>C</sub> =-10μA, I <sub>E</sub> =0	-60			V
Emitter-Base Breakdown Voltage	BV <sub>EBO</sub>	I <sub>E</sub> =-10μA, I <sub>C</sub> =0	-5			V
Base Cutoff Current	I <sub>B</sub>	V <sub>CB</sub> =-30V, V <sub>EB</sub> =-0.5V			-50	nA
Collector Cutoff Current	I <sub>CEX</sub>	V <sub>CE</sub> =-30V, V <sub>BE</sub> =-0.5V			-50	nA
Collector Cutoff Current	I <sub>CBO</sub>	V <sub>CB</sub> =-50V, I <sub>E</sub> =0 V <sub>CB</sub> =-50V, I <sub>E</sub> =0, Ta=150°C			-0.02 -20	μA μA
<b>ON CHARACTERISTICS</b>						
DC Current Gain	h <sub>FE</sub>	I <sub>C</sub> =-0.1mA, V <sub>CE</sub> =-10V	75			
		I <sub>C</sub> =-1.0 mA, V <sub>CE</sub> =-10V	100			
		I <sub>C</sub> =-10 mA, V <sub>CE</sub> =-10V	100			
		I <sub>C</sub> =-150 mA, V <sub>CE</sub> =-10V (Note)	100		300	
		I <sub>C</sub> =-500 mA, V <sub>CE</sub> =-10V (Note)	50			
Collector-Emitter Saturation Voltage (Note)	V <sub>CE(SAT)</sub>	I <sub>C</sub> =-150mA, I <sub>B</sub> =-15mA I <sub>C</sub> =-500mA, I <sub>B</sub> =-50mA			-0.4 -1.6	V V
Base-Emitter Saturation Voltage	V <sub>BE(SAT)</sub>	I <sub>C</sub> =-150mA, I <sub>B</sub> =-15mA (Note) I <sub>C</sub> =-500mA, I <sub>B</sub> =-50mA			-1.3 -2.6	V V
<b>SMALL SIGNAL CHARACTERISTICS</b>						
Current Gain – Bandwidth Product	f <sub>T</sub>	I <sub>C</sub> =-50mA, V <sub>CE</sub> =-20V, f=100MHz	200			MHz
Output Capacitance	C <sub>ob</sub>	V <sub>CB</sub> =-10V, I <sub>E</sub> =0, f=100kHz			8	pF
Input Capacitance	C <sub>ib</sub>	V <sub>EB</sub> =-2V, I <sub>C</sub> =0, f=100kHz			30	pF
<b>SWITCHING CHARACTERISTICS</b>						
Turn-on Time	t <sub>ON</sub>	V <sub>CC</sub> =-30V, I <sub>C</sub> =-150mA I <sub>B1</sub> =-15mA			45	ns
Delay Time	t <sub>DLY</sub>				10	ns
Rise Time	t <sub>R</sub>				40	ns
Turn-off Time	t <sub>OFF</sub>	V <sub>CC</sub> =-6V, I <sub>C</sub> =-150mA I <sub>B1</sub> =I <sub>B2</sub> =-15mA			100	ns
Storage Time	t <sub>S</sub>				80	ns
Fall Time	t <sub>F</sub>				30	ns

Note: Pulse Test: Pulse Width ≤ 300ms, Duty Cycle ≤ 2.0%

### ■ TEST CIRCUITS

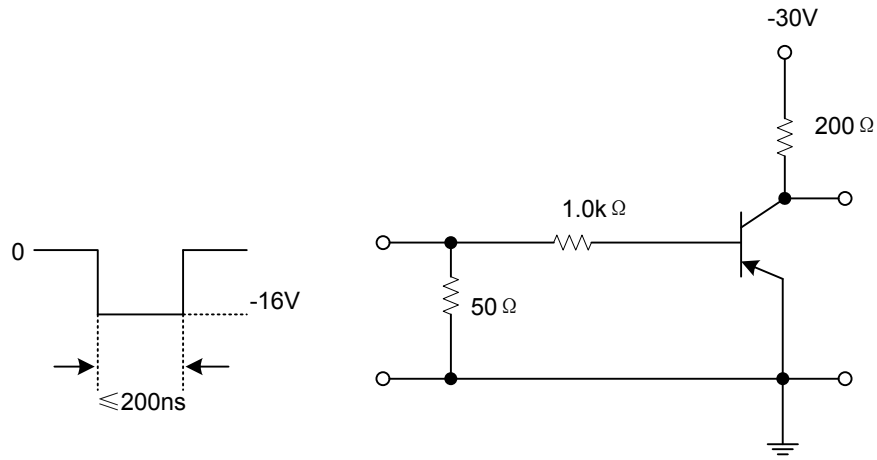

Fig. 1 Saturated Turn-On Switching Time Test Circuit

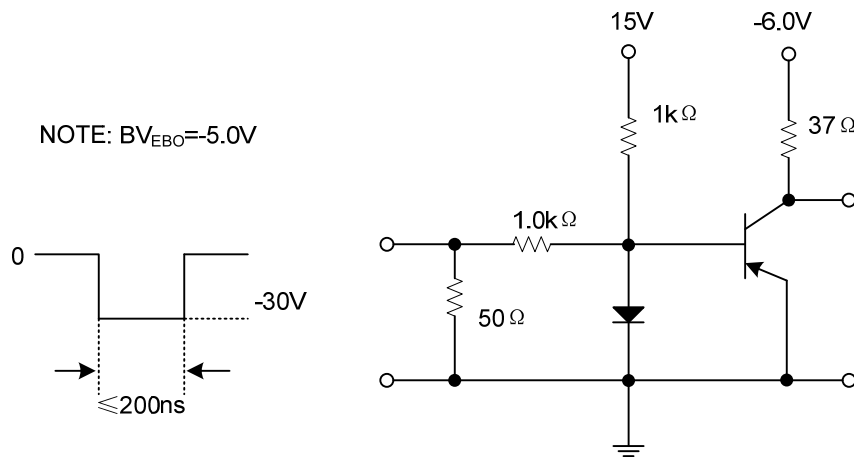
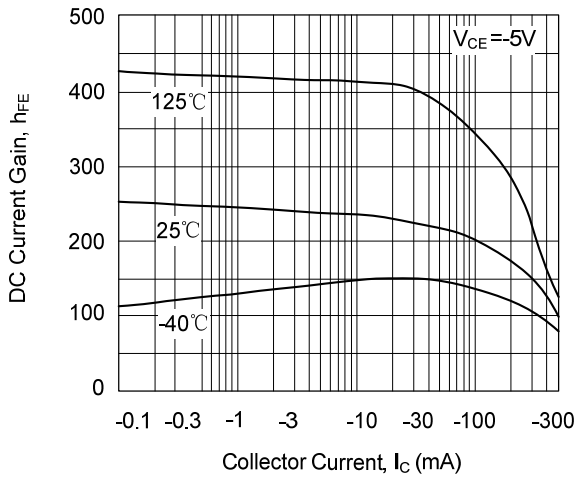

Fig. 2 Saturated Turn-Off Switching Time Test Circuit

### TYPICAL CHARACTERISTICS

Typical Pulsed Current Gain vs. Collector Current



Collector-Emitter Saturation Voltage vs. Collector Current

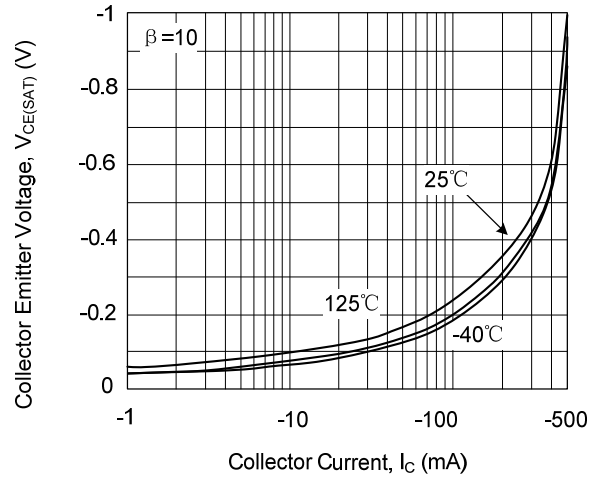

Base-Emitter Saturation Voltage vs. Collector Current

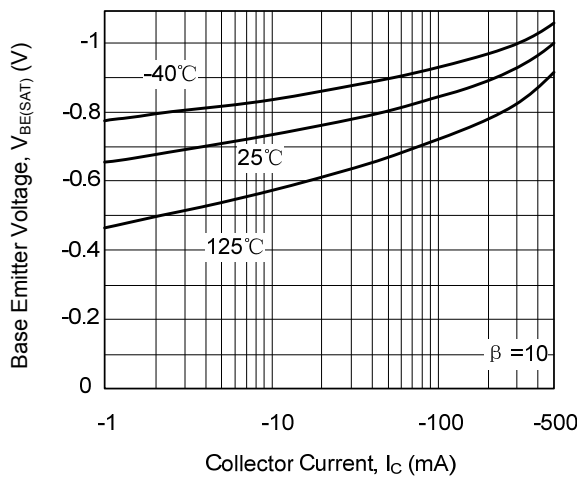

Base Emitter ON Voltage vs. Collector Current

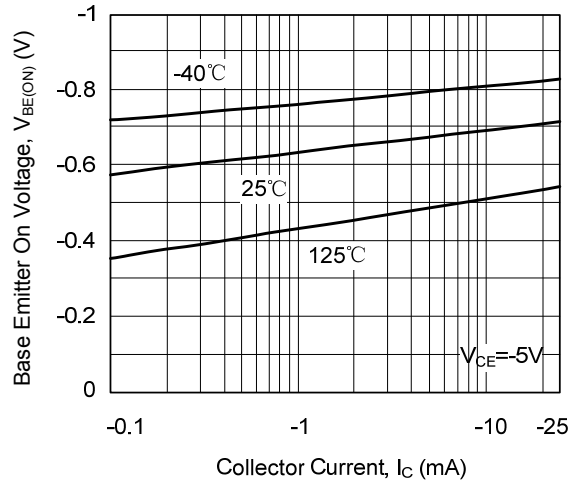

Collector-Cutoff Current vs. Ambient Temperature

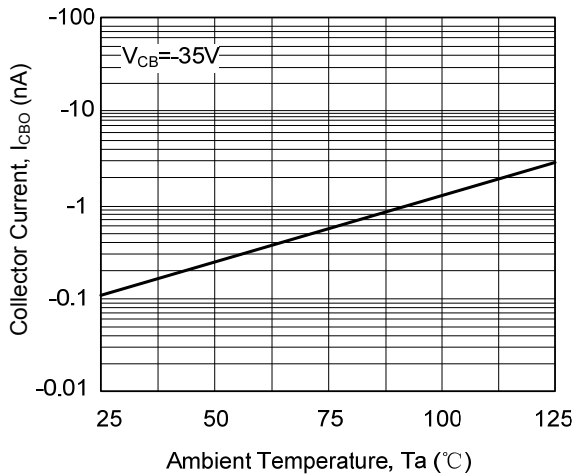

Input and Output Capacitance vs. Reverse Bias Voltage

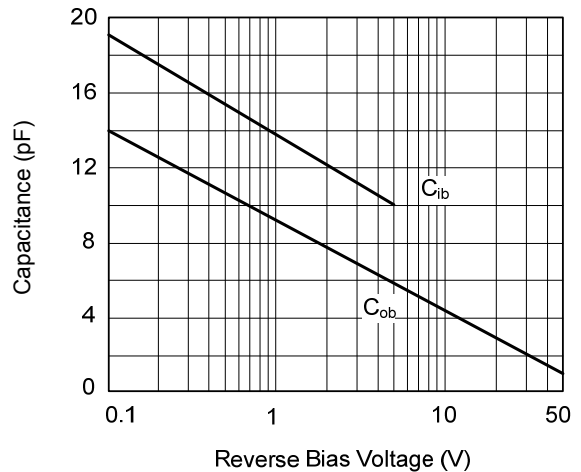

## TYPICAL CHARACTERISTICS(Cont.)

Switching Times vs. Collector Current

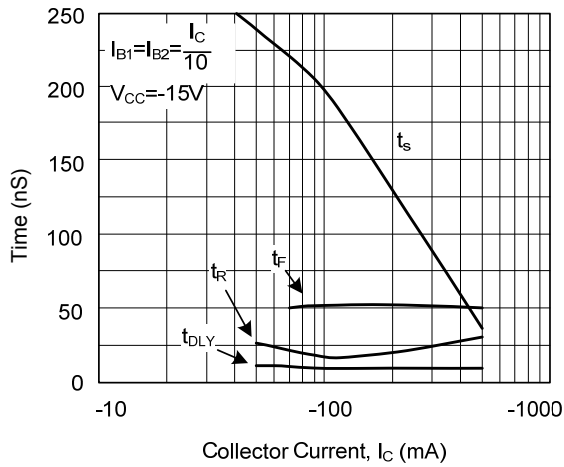

Turn On and Turn Off Times vs. Collector Current

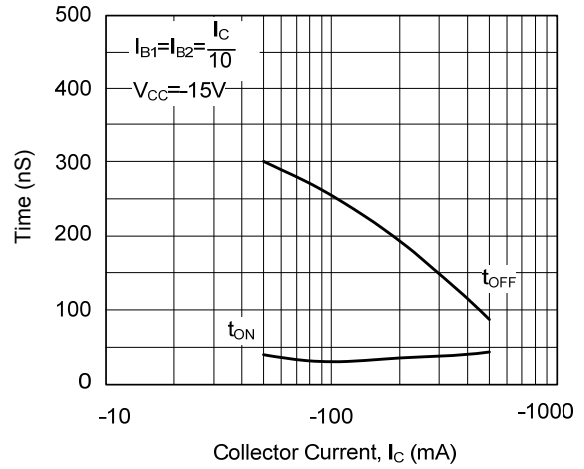

Rise Time vs Collector and Turn On Base Currents

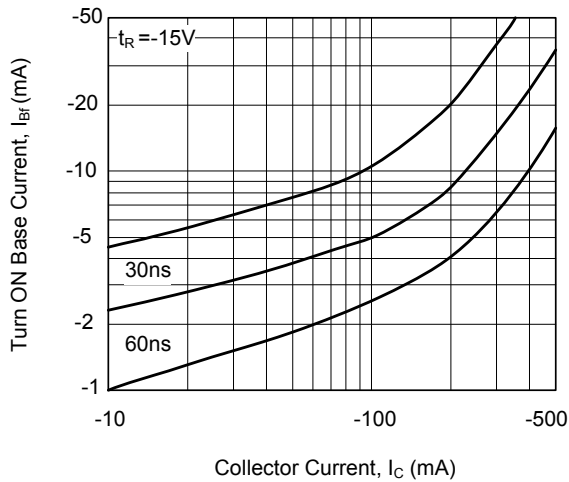

## TYPICAL CHARACTERISTICS FOR COMMON EMITTER (f=1kHz)

Common Emitter Characteristics

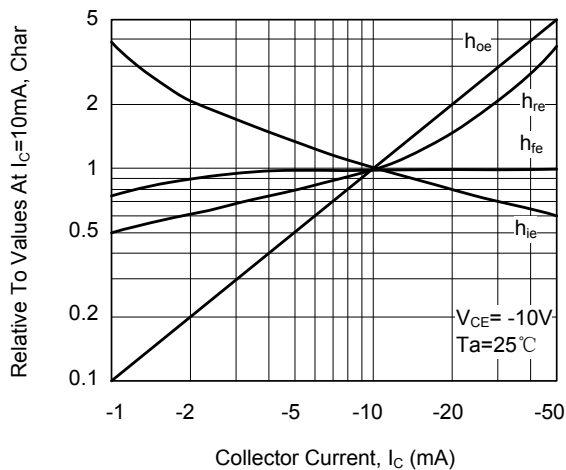

Common Emitter Characteristics

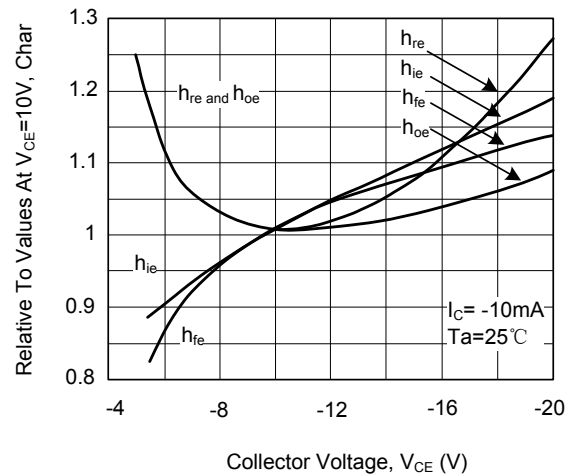

■ TYPICAL CHARACTERISTICS FOR COMMON EMITTER(Cont.)

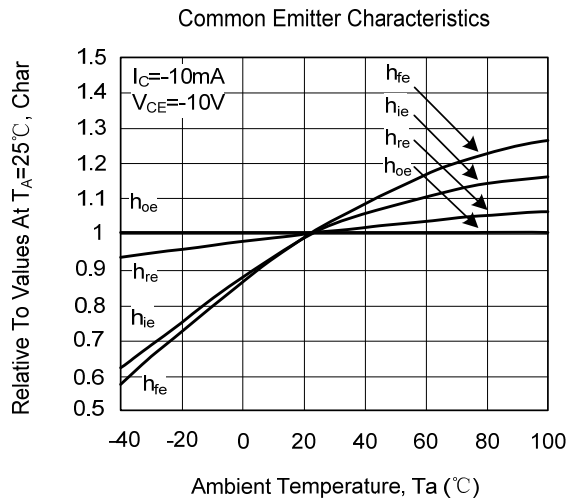

UTC assumes no responsibility for equipment failures that result from using products at values that exceed, even momentarily, rated values (such as maximum ratings, operating condition ranges, or other parameters) listed in products specifications of any and all UTC products described or contained herein. UTC products are not designed for use in life support appliances, devices or systems where malfunction of these products can be reasonably expected to result in personal injury. Reproduction in whole or in part is prohibited without the prior written consent of the copyright owner. The information presented in this document does not form part of any quotation or contract, is believed to be accurate and reliable and may be changed without notice.



## Стандарт Электрон Связь

Мы молодая и активно развивающаяся компания в области поставок электронных компонентов. Мы поставляем электронные компоненты отечественного и импортного производства напрямую от производителей и с крупнейших складов мира.

Благодаря сотрудничеству с мировыми поставщиками мы осуществляем комплексные и плановые поставки широчайшего спектра электронных компонентов.

Собственная эффективная логистика и склад в обеспечивает надежную поставку продукции в точно указанные сроки по всей России.

Мы осуществляем техническую поддержку нашим клиентам и предпродажную проверку качества продукции. На все поставляемые продукты мы предоставляем гарантию .

Осуществляем поставки продукции под контролем ВП МО РФ на предприятия военно-промышленного комплекса России , а также работаем в рамках 275 ФЗ с открытием отдельных счетов в уполномоченном банке. Система менеджмента качества компании соответствует требованиям ГОСТ ISO 9001.

Минимальные сроки поставки, гибкие цены, неограниченный ассортимент и индивидуальный подход к клиентам являются основой для выстраивания долгосрочного и эффективного сотрудничества с предприятиями радиоэлектронной промышленности, предприятиями ВПК и научно-исследовательскими институтами России.

С нами вы становитесь еще успешнее!

### Наши контакты:

**Телефон:** +7 812 627 14 35

**Электронная почта:** [sales@st-electron.ru](mailto:sales@st-electron.ru)

**Адрес:** 198099, Санкт-Петербург,  
Промышленная ул, дом № 19, литера Н,  
помещение 100-Н Офис 331