

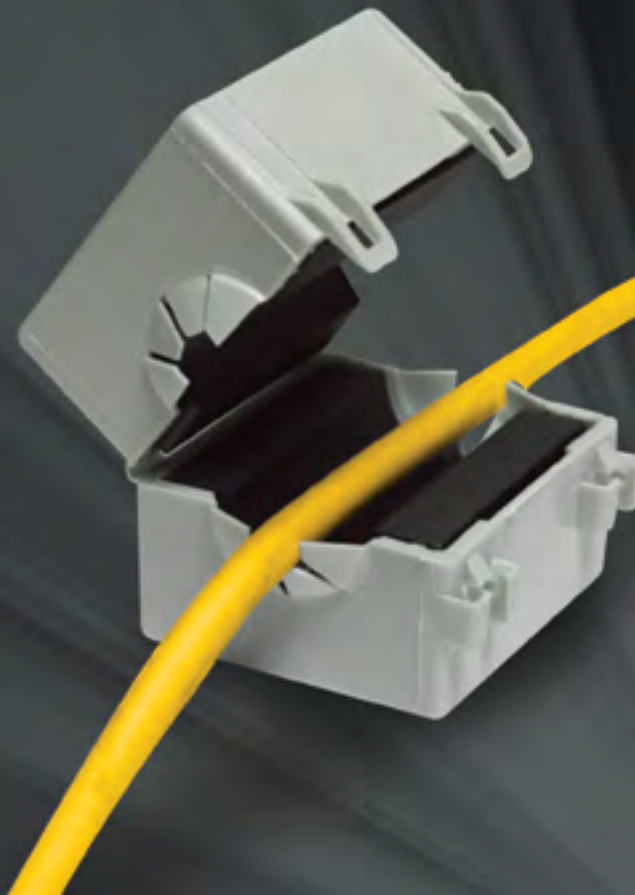

FERRISHIELD **FERRITES**

**BISECTED & SOLID BEAD STYLES
FOR ROUND AND FLAT CABLES & WIRES**

- World's Largest In-Stock Selection
- Frequency-Specific Formulations
- Flexible Mounting Options



**LEADER
TECH**
a HEICO company 

The Leading Edge in EMI Shielding Technology

For more than 25 years, FerriShield ferrites have been the preferred cable shielding solution for many of the world's leading EMI Shielding Distributors, Sales Representatives and OEM's. Since acquiring the company in 2006, Leader Tech has embraced the FerriShield philosophy of maintaining the world's largest in-stock selection of bisected and solid core ferrites.



The addition of cable mounted ferrites to Leader Tech's existing EMI shielding product line has significantly increased value for our customers. Backed by unparalleled service and engineering support, Leader Tech now offers the market's most reliable selection of board, enclosure and cable shielding solutions.



FerriShield[®] Ferrite Suppressors

Shielded enclosures, even the most robust designs, will permit electromagnetic energy to enter or exit along the main cabling. FerriShield Ferrites are one of the most versatile and cost-effective cable shielding methods available today. Our ferrites attack unwanted RF right on the circuit wiring, eliminating the need for more costly forms of RFI control. Available in solid and bisected designs, each style can make the task of regulatory compliance quicker and less troublesome.

Our bisected styles use FerriShield's innovative, quick-snap clamshell enclosures. This unique design concept offers engineers the ultimate in adaptability and easy installation. The RF absorbing core material interacts directly with unwanted high-frequency energy and dissipates it effectively while allowing data signals to pass unimpeded.



ferrites for flat and round cables

Universal Wideband Material (28 Material)

- 10 cable snaps
for round cables
- 12 sleeve snaps
for round cables
- 13 USB cable sleeve snap
with universal variable diameter
- 14 cable bundle clamps
for wire and cable groups
- 14 telecom cable snaps
for flat-oval cables
- 15 solid beads and toroids
for round cables
- 15 extra large toroids
up to 6.66" inside diameter
- 16 flat cable clamps
for flat cables and flex circuits
- 16 low profile flat cable clamps
for flat cables and flex-circuits
- 19 low profile solids
for flat cables and flex-circuits
- 19 rectangular solids
for flat cables and flex circuits
- 21 universal wideband bus bar ferrites
extra large openings for most sizes

Low-Frequency Material (33 Material)

- 22 low frequency cable snaps
for round cables
- 23 low frequency cable clamps
for flat cables and flex circuits

High-Frequency Material (25 Material)

- 24 high frequency cable snaps
for round cables
- 25 high frequency cable clamps
for flat cables and flex circuits

Bluetooth/Microwave Material (20 Material)

- 26 bluetooth/microwave cable snaps
for round cables
- 27 bluetooth/microwave cable clamps
for flat cables

RFID shielding

- 28 RFID overview
13.56, 433.32, 860-930 MHz; 2.45 & 5.8 GHz
- 29 frequency-specific ferrites
13.56, 433.32, 860-930 MHz; 2.45 & 5.8 GHz

electrical and mechanical specifications

- 7 insertion loss formula
simple engineering calculation model
- 9 technical information
for specifying products
- 32 attenuation by part number
impedance performance by frequency
- 33 material properties
typical performance characteristics
- 33 cable size by part number
recommended cable sizes

testing aids

- 30 engineering kits and test equipment
test fixtures, test probes
- 34 test probes
electric and magnetic near-field detectors

installation, ordering, part # reference

- 35 installation guidelines for ferrites
cable size, positioning, attachment options
- 36 all part numbers by page number
all catalog items in stock at all times
- 39 ordering
general information, customer samples,
ISO 9001:2008 Quality System Registration, RoHS



Simply one of the most flexible
and cost-effective cable shielding
solutions on the market



PRODUCT OVERVIEW:

4 Frequency-Specific Ferrite Formulations

- 28 Material Wideband Ferrite (Most Popular)
- 33 Material Low-Frequency Ferrite
- 25 Material High-Frequency Ferrite
- 20 Material Bluetooth/Microwave Ferrite

1,000s of Styles and Sizes

- Solid and Bisected Styles
- I.D.'s from .034" to 6.6"
- Round, Square & Flat Shapes
- Special application designs

10 Flexible, Quick Mounting Options

Integrated Mounting Options:

- Snug Cable-Fit
- Button Mount
- Adhesive Mount
- Screw Mount
- Flexible-Grip End Ports

2-Piece Mounting Options:

- Cable Tie Base
- Press Fit Base
- Adhesive Mount Base
- Screw Mount Base
- Screw Mount Strap

www.leadertechinc.com

ISO 9001:2008 registered



HOW TO select a FerriShield Ferrite for your application

1 Choose a ferrite material

FerriShield ferrites are offered in (4) unique formulations. The chart below offers an overview of typical material properties and catalog page references.

Ferrite	Performance	Catalog Pages
28 Material- Most Popular Wideband	10MHz-1GHz (250MHz peak)	10 to 21
33 Material- Low-Frequency Ferrite	1MHz-60MHz (30MHz peak)	22 to 23
25 Material- High-Frequency Ferrite	1MHz-1.2GHz (700MHz peak)	24 to 25
20 Material- Bluetooth/Microwave	2.45GHz peak	26 to 27

For detailed Attenuation and Material Properties see page 32 and 33



2 Select a mounting option

Each section of this catalog features multiple mounting options for bisected and solid bead ferrites. FerriShield Ferrites are recognized for their ease of installation and reliable performance over time.



3 Select the inside diameter of your ferrite

FerriShield Ferrites are designed to fit tight against the cable or wiring bundle that requires shielding. Ideally, you should select a ferrite with an inside diameter that is slightly less (+/- .04") than the outside diameter of your cable.

For quick reference, all part numbers in this catalog have an accompanying technical drawing and specifications chart that illustrates dimensions and impedance for the selected ferrite.

For a more detailed technical explanation see page 33.



Helpful Tips and Insider Hints

- Ferrite performance typically increases as ferrite volume increases. The larger the ferrite mass, the better the RF attenuation.
- Smaller cables can be looped through larger ferrites to increase performance. Impedance increase by the square of the number of loops. For example, by looping a cable through a ferrite 2 times (2^2), impedance increases by a factor of 4.

For a detailed explanation see page 6- Electromagnetic Characteristics

- Ferrite installation guidelines and recommendations are shown on page 35
- Attenuation properties by part number can be referenced on page 32
- Maximum recommend cable size by part number can be found on page 33



Product Profile

Ferrite shielding materials are widely accepted as providing the simplest, most convenient and most cost-effective solution for radio frequency interference problems in cables and connectors. Further, they accomplish both RF attenuation and suppression of unwanted high frequency oscillations with no loss in dc or low frequency signal strength.

The basic composition of ferrite materials is a combination of ferrous oxide and one or more other powdered metals - most often manganese, zinc, cobalt or nickel. An extensive selection of shapes and sizes is already available, and custom geometries may be manufactured for special situations.

There are infinite varieties of formulas and performance levels possible. Each discrete ferrite formulation results in a stoichiometric ratio which is its performance characteristic signature regarding electrical, magnetic and mechanical relationships. The most common expression of ferrites' performance capabilities is in terms of their permeability (μ). This property expresses the ratio of the magnitude of magnetic induction to magnetizing force. The materials are normally categorized according to initial permeability (μ_i).

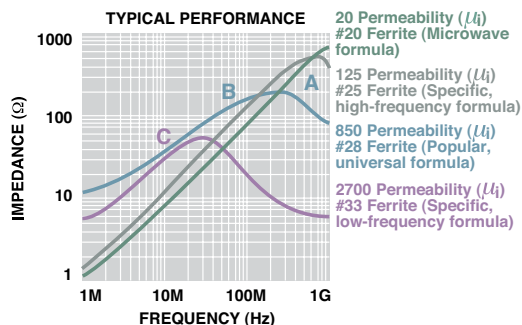

fig. 1 Typical attenuation profiles

FerriShield has developed four principal formulations which together serve the common spectrum of today's RFI needs. For frequencies from 10 MHz to 1 GHz, #28 formulation is recommended, especially when higher frequency harmonics are a consideration. For frequencies typified by microprocessor speeds in excess of 100MHz and harmonics peak interference at nominally 700MHz, #25 formulation is designed to cover this range with even some effect beyond that. For frequencies from 1 MHz to 30 MHz, #33 material offers a concentration of impedance in that range with a decreasing effect above 30 MHz. For microwave frequencies relating to Bluetooth™ 2.45GHz operations, the #20 material is available. See figure 1 above.

Electromagnetic Characteristics

Stated most simply, the operative characteristic which makes ferrites effective in RFI/EMI suppression is their variable sensitivity to frequency. With a ferrite installed as a suppressor, lower frequencies will pass with no significant loss. But above the frequency where $(\tan \delta/\mu)$ climbs sharply (see figure 1), the signal couples with the ferrite to create an impedance which is quite high compared with the rest of the circuit. The offending RFI is thus immediately and consistently blocked out by way of impedance damping of the unwanted high frequency signals. It is this greater resistive impedance which allows the basically passive, apparently simple material to suppress multiple signals in a variety of application situations.

fig. 2 Impedance comparison vs. cubic volume.



fig. 3 Two turn loop through ferrite increases effective magnetic path. Impedance increases by the square of the number of turns (N^2).



fig. 4 Increased impedance; multiple turns (N^2) vs. one turn through ferrite; i.e., 2 turns (2^2) = 4 times impedance

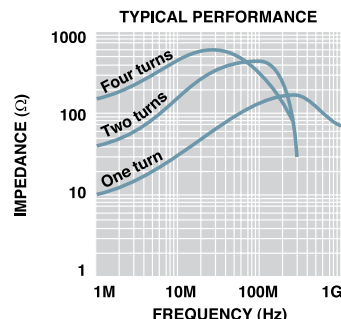



Organizing the Engineering Model

To understand the various practical modeling techniques employed with ferrite, it is best to prepare a properly engineered calculation of expected results. An empirical trial and error method may leave the circuit close to borderline performance without adequate safety margins. As indicated previously, a wide range of formulations is possible. The major application factors to be used when defining a specific ferrite solution for a particular interference problem include the following:

- Frequency where maximum attenuation is required.
- Amount of attenuation needed.
- Ferrite permeability formulation characteristics as they relate to the frequency range in question (i.e., initial permeability)
- Ferrite formulation consistency (i.e., expected range of variation in attenuation performance)
- Installation environment and mechanical attachment requirements.

The frequency range requiring attenuation must be matched to the performance of a given ferrite composition (figure 1 on previous page). The optimum profile would be a ferrite in which the highest attenuation level coincides with the disruptive frequency (A). That same ferrite could be used even if the frequency falls in a lower area of its impedance curve (B) but there would be correspondingly reduced attenuation. Conversely, a different ferrite formulation could be employed in the same frequency situation with the intent of using a lower part of its performance curve (C). Space and weight considerations are not normally a concern since good quality ferrites provide high performance per a given cubic volume.

The modeling procedure to calculate impedance characteristics of the source and load coupled with the ferrite suppressor is developed as follows:

$$\text{Insertion Loss (dB)} = 20 \log_{10} \frac{(Z_A + Z_B + Z_F)}{(Z_A + Z_B)}$$

Where:

Insertion Loss = A measure of the effectiveness of a filter, expressed in decibels, is described as the ratio of voltages with, and without, the filter in the circuit.

- Z_A = Source Impedance
- Z_B = Load Impedance
- Z_F = Ferrite Impedance

If the circuit impedance ($Z_A + Z_B$) is 50 ohms and the ferrite impedance is 250 ohms, then the insertion loss will be:
 $20 \log_{10} (50+250)/50 = 15.56 \text{ dB}$

Even though the same unit of ferrite is used, the attenuation provided by a ferrite suppressor can differ somewhat as the original circuit impedance varies. The ferrite is more effective when the circuit impedance is low. For example, by using the same 250 ohm ferrite in a 75 ohm circuit, the result will be:

$$20 \log_{10} (75 + 250)/75 = 12.7 \text{ dB}$$

With a high circuit impedance, it may be possible to increase the number of turns or passes through the ferrite (figures 3 and 4), or to use a larger amount of ferrite (cubic volume) in the circuit in order to achieve the same level of insertion loss (fig. 2). By increasing the number of turns (passes) through the ferrite opening, the "effective magnetic path" is increased – impedance then increases by the square of the number of turns (N^2); i.e., two turns (2^2) = 4 times the impedance. When additional ferrite volume is added, impedance increases on almost a direct percentage basis; i.e., a 100 percent increase in volume will provide about 100 percent increase in impedance (figure 2) in most situations according to certain prescribed dimensional ratios.

An alternative modeling procedure may also be structured in reverse by solving for a desired insertion loss goal. The result yields an impedance requirement. This can be matched to known performance profiles of existing ferrite configurations in the geometric style best suited for mechanical and packaging requirements.

As an example, a 15dB insertion loss is required for a flat ribbon cable at 100 MHz. Using the formula:

$$\text{Insertion Loss (dB)} = 20 \log_{10} \frac{(Z_A + Z_B + Z_F)}{(Z_A + Z_B)}$$

Where: IL = 15 dB

Z_A = 25 ohms

Z_B = 25 ohms

Z_F = Unknown ferrite impedance
(solve for this value)

$$15\text{dB} = 20 \log_{10} \left(\frac{50 + Z_F}{25 + 25} \right)$$

$$0.75 = \log_{10} \left(\frac{50 + Z_F}{50} \right)$$

$$5.625 = \frac{50 + Z_F}{50}$$

$$Z_F = 231.25 \text{ ohms}$$

Next, refer to the Attenuation Properties on page 36. The flat ribbon cable style part that closely matches is #28B2480 with a 250½ impedance at 100 MHz.

Once the ferrite suppressor is installed in the circuit, results should be confirmed by testing. Although these ferrites are "linear," the term is relative to the common operating range of temperatures. The permeability is different at every degree of temperature. The published initial permeability (μ_i) nomenclature applies to standard temperature, 59°F (15°C) only. There are only minor impedance differences, however, throughout normal operational ranges and up to 180° F (82°C). See Material Properties on page 33.

Controlling RFI/EMI

Any device used to block an RFI signal between its source and a receiver is an electromagnetic interference (EMI) shield.

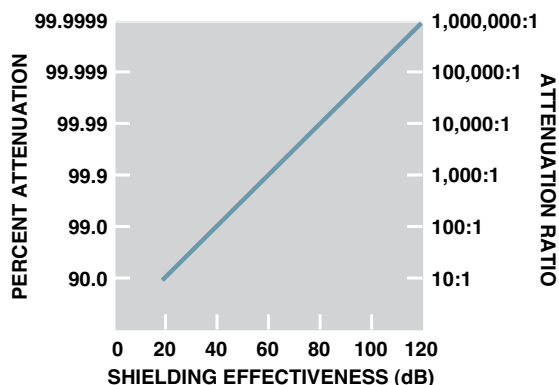

The measure of this ability to attenuate RFI is Shielding Effectiveness, SE, which is expressed in decibels, dB, the ratio of field strength on one side of the shield to the other side. The figure above shows the relationship between shielding effectiveness (in dB), the amount of attenuation, and attenuation percentage.

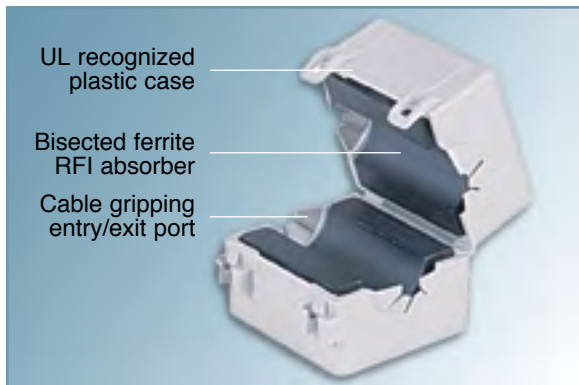

Typical FerriShield RFI suppressor.

FerriShield Advantages



I/O cable with RFI suppressor.

The concept of bisected ferrites has been developed to address a number of industry needs in the area of Electromagnetic Compatibility, EMC.

- engineering adaptability
- risk-free engineering:
 - tight tolerance performance
 - easy to upgrade attenuation by changing size or number of turns.
- easy retrofitting
- convenient installation
- integral mounting features
- cost-effectiveness
- extended resistance to core saturation under Direct Current loads.
- consistent performance

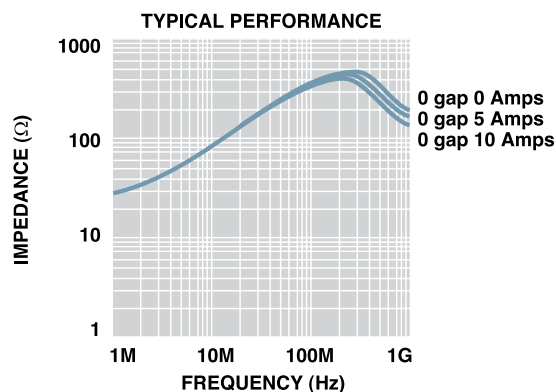

Gap effect of ferrite subjected to direct current.

Design Support

Engineering assistance is always available. We will be pleased to help with applications, cross-referencing or complete insertion loss calculations when a custom suppressor is required.

The technical air gap in bisected ferrites actually extends current carrying capability with only an imperceptible reduction in impedance versus solid ferrites of the same size. The gap is magnetically insignificant while it is electrically significant as a discontinuation, thereby accommodating more current.

Installation is simple

Just snap over circuit wiring to be controlled - even after wiring has been terminated Radio interference sources usually radiate their RFI power at frequencies above 30 MHz by way of the main cabling, which acts as an antenna.

Anywhere There is an Antenna-Like Structure

Electronic cabling and wires, by virtue of their length-to-width ratios, are perfect natural antennas. In the presence of high speed microprocessor signals, cables will conduct, radiate and/or receive unwanted high frequency interfering signals. Control of radio frequency interference can be assured by proper placement of an insertion loss device, such as a ferrite suppressor.

CABLING

RFI suppressor functions

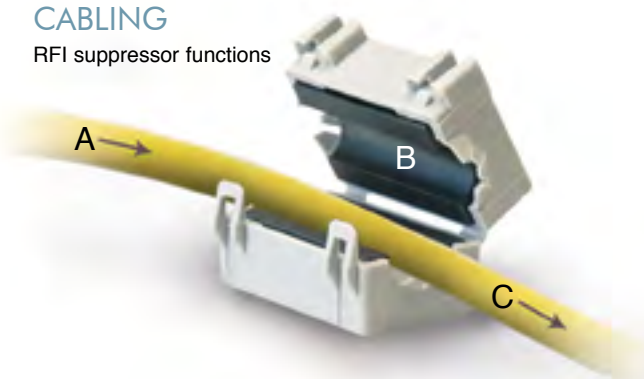

- A. Data signals and high frequency interference signals absorbed and conducted
- B. All high frequency interference absorbed by ferrite suppressor and thermally dissipated
- C. Low frequency data signals pass unimpeded

BUS BARS

RFI suppressor functions: bus bars

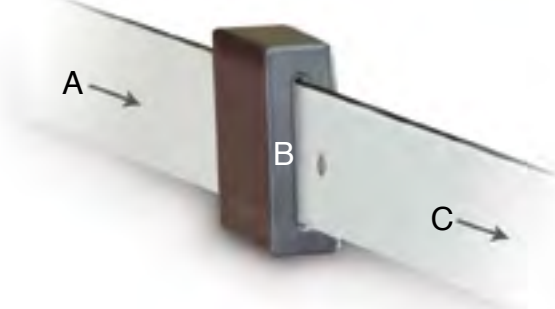

- A. Power distribution and high frequency interference signals absorbed and conducted
- B. All high frequency interference absorbed by ferrite suppressor and thermally dissipated
- C. Power distribution characteristics pass unimpeded

Application Points

FerriShield installation locations.



Advantages

Compared to other alternatives, ferrites' high resistivity per cubic volume stands out as the most important advantage. Prior to the development of bisected ferrites, suppression engineering was restricted to the costly addition of filters, cable shielding, and less versatile solid core (not bisected) ferrites. While these methods offer a degree of suppression, they are often awkward to install and, in many cases, are not completely effective. Bisected ferrites have a concentrated, homogeneous magnetic structure with high permeability. They are consistently stable versus time and temperature, and provide RF suppression without high eddy current losses.



cable snap

Ferrite assembly in fully enclosed nylon case; functional with wires and cables up to a 2.0" (50,8mm) diameter. Snap closed around wire by clasping shut to position assembly.

May also be mounted with a flat-head screw through the .120" (3,0mm) diameter hole in the bottom by temporarily removing lower ferrite half.

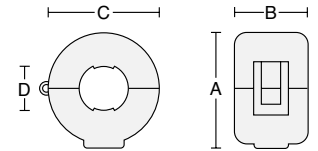

PART No.	A	B	C	D	IMPEDANCE IN OHMS
CS28B1642	.852 21,6	.885 22,5	.840 21,3	.282 7,2	100 @ 100MHz
CS28B1805	1.040 26,4	.667 16,9	1.025 26,4	.340 8,6	73 @ 100MHz
CS28B1937	1.182 30,0	.780 19,8	1.188 30,2	.425 10,8	117 @ 100MHz
CS28B1984	1.218 30,9	.705 17,9	1.220 31,0	.525 13,3	62 @ 100MHz
CS28B1501	1.725 43,8	1.232 31,3	1.720 43,7	.710 18,0	177 @ 100MHz
CS28B1500	1.725 43,8	1.232 31,3	1.720 43,7	.960 24,4	133 @ 100MHz
CS28B2000	2.350 59,7	1.851 47,0	2.309 58,6	.960 24,4	380 @ 100MHz
CS28B4000	4.500 114,2	1.851 47,0	4.687 119,0	1.960 49,8	290 @ 100MHz

See page 31 for more details



cable snap

WITH PRESS-FIT BUTTON MOUNT BASE. Ferrite assembly in fully enclosed nylon case; functional with wires and cables up to a 1.0" (25,4mm) diameter. Includes a button mount base which press-fits into a .150" (3,8mm) diameter hole.

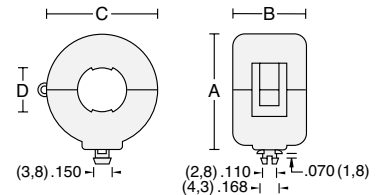

PART No.	A	B	C	D	IMPEDANCE IN OHMS
CF28B1642	.852 21,6	.885 22,5	.840 21,3	.282 7,2	100 @ 100MHz
CF28B1805	1.040 26,4	.667 16,9	1.025 26,4	.340 8,6	73 @ 100MHz
CF28B1937	1.182 30,0	.780 19,8	1.188 30,2	.425 10,8	117 @ 100MHz
CF28B1984	1.218 30,9	.705 17,9	1.220 31,0	.525 13,3	62 @ 100MHz
CF28B1501	1.725 43,8	1.232 31,3	1.720 43,7	.710 18,0	177 @ 100MHz
CF28B1500	1.725 43,8	1.232 31,3	1.720 43,7	.960 24,4	133 @ 100MHz
CF28B2000	2.350 59,7	1.851 47,0	2.309 58,6	.960 24,4	380 @ 100MHz



cable snap

WITH ADHESIVE MOUNT BASE. Ferrite assembly in fully enclosed nylon case; various sizes are functional with wires and cables up to a 1.0" (25,4mm) diameter. After closing around wire and clasping shut, assembly is ready for mounting. Installs by removing protective paper strip from base and pressing into place.

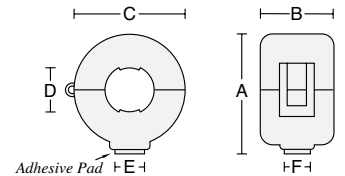

PART No.	A	B	C	D	E	F	IMPEDANCE IN OHMS
CA28B1642	.882 22,4	.885 22,5	.840 21,3	.282 7,2	.375 9,5	.375 9,5	100 @ 100MHz
CA28B1805	1.070 27,2	.667 16,9	1.025 26,4	.340 8,6	.375 9,5	.375 9,5	73 @ 100MHz
CA28B1937	1.212 30,8	.780 19,8	1.188 30,2	.425 10,8	.375 9,5	.375 9,5	117 @ 100MHz
CA28B1984	1.248 31,7	.705 17,9	1.220 31,0	.525 13,3	.375 9,5	.375 9,5	62 @ 100MHz
CA28B1501	1.755 44,6	1.232 31,3	1.720 43,7	.710 18,0	.875 22,2	.875 22,2	177 @ 100MHz
CA28B1500	1.755 44,6	1.232 31,3	1.720 43,7	.960 24,4	.875 22,2	.875 22,2	133 @ 100MHz
CA28B2000	2.380 60,5	1.851 47,0	2.309 58,6	.960 24,4	1.000 25,4	1.500 38,1	380 @ 100MHz



cable snap

WITH SCREW MOUNT BASE. Ferrite assembly in fully enclosed nylon case; various sizes are functional with wires and cables up to a 1.0" (25,4mm) diameter. Mounting base press-fits into receptacle on bottom. Installs at the intended location with a screw through the .125" (3,2 mm) diameter hole provided. The base may be positioned at 90° increments relative to the upper case to provide four alternative assembly configurations.

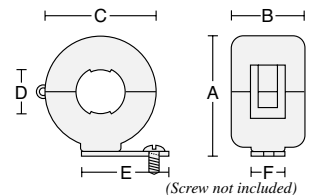

PART No.	A	B	C	D	E	F	IMPEDANCE IN OHMS
CW28B1642	.916 23,3	.885 22,5	.840 21,3	.282 7,2	1.250 31,8	.375 9,5	100 @ 100MHz
CW28B1805	1.105 28,1	.667 16,9	1.025 26,4	.340 8,6	1.250 31,8	.375 9,5	73 @ 100MHz
CW28B1937	1.236 31,4	.780 19,8	1.188 30,2	.425 10,8	1.250 31,8	.375 9,5	117 @ 100MHz
CW28B1984	1.282 32,6	.705 17,9	1.220 31,0	.525 13,3	1.250 31,8	.375 9,5	62 @ 100MHz
CW28B1501	1.789 45,5	1.232 31,3	1.720 43,7	.710 18,0	1.250 31,8	.375 9,5	177 @ 100MHz
CW28B1500	1.789 45,5	1.232 31,3	1.720 43,7	.960 24,4	1.250 31,8	.375 9,5	133 @ 100MHz
CW28B2000	2.414 61,3	1.851 47,0	2.309 58,6	.960 24,4	1.250 31,8	.375 9,5	380 @ 100MHz



cable snap

WITH VARIABLE DIAMETER END PORTS. Ferrite assembly in fully enclosed nylon case; various sizes are functional with wires and cables up to a .500 (12,7 mm) diameter. End ports are surrounded with flexible spring flutes to grip a range of cable diameters from .120" to .500" (3,2 to 12,7 mm). The grip-locking action prevents lateral movement along the cable or wire bundle.

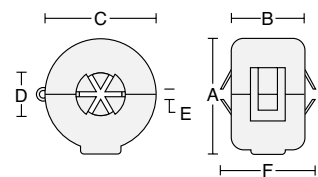

Patent No. 5,003,278

PART No.	A	B	C	D	E	F (ref.)	IMPEDANCE IN OHMS
CV28B1642	.852 21,6	.885 22,5	.840 21,3	.282 7,2	.120 3,0	1.020 25,9	100 @ 100MHz
CV28B1805	1.040 26,4	.667 16,9	1.025 26,4	.340 8,6	.120 3,0	.820 20,8	73 @ 100MHz
CV28B1937	1.182 30,0	.780 19,8	1.188 30,2	.375 9,5	.120 3,0	.950 24,1	117 @ 100MHz
CV28B1984	1.218 30,9	.705 17,9	1.220 31,0	.500 12,7	.120 3,0	.940 23,9	62 @ 100MHz



cable snap

Ferrite assembly in fully enclosed nylon case; functional with wires and cables up to a .520" (13,2mm) diameter. Snap closed around wire by clasp shut to position assembly. Cable tie-wraps may be threaded through the loops on each side.

Larger I.D.'s permit multiple cable turns for greater impedance effect. See page 6, figures 3 and 4.

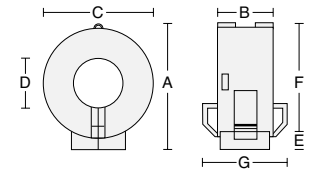

PART No.	A	B	C	D	E	F	G	IMPEDANCE IN OHMS
CS28B0642	.923 23,4	.708 18,0	.780 19,8	.300 7,6	.143 3,6	.818 20,8	1.000 25,4	100 @ 100MHz
CS28B0805	1.095 27,8	.476 12,1	.965 24,5	.345 8,8	.100 2,5	1.003 25,5	.890 22,6	73 @ 100MHz
CS28B0937	1.222 31,0	.691 17,6	1.078 27,4	.425 10,8	.098 2,5	1.116 28,3	.930 23,6	117 @ 100MHz
CS28B0984	1.275 32,3	.547 13,9	1.145 29,1	.525 13,3	.095 2,4	1.183 30,0	.867 22,0	62 @ 100MHz



cable snap

WITH PRESS FIT MOUNT. Ferrite assembly in fully enclosed nylon case; various sizes are functional with wires and cables up to a .520" (13,2mm) diameter. After closing around wire and clasping shut, assembly snap-fits into mounting base. Base may be installed either before or after product assembly by pressing the integral spring tab fastener into a .187" (4,7mm) diameter hole.

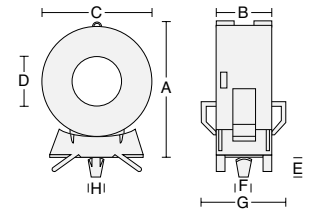

PART No.	A	B	C	D	E	F	G	H	IMPEDANCE IN OHMS
CF28B0642	.995 25,2	.708 18,0	.780 19,8	.300 7,6	.280 7,1	.183 4,6	1.000 25,4	.240 6,1	100 @ 100MHz
CF28B0805	1.180 30,0	.476 12,1	.965 24,5	.345 8,8	.280 7,1	.183 4,6	.890 22,6	.240 6,1	73 @ 100MHz
CF28B0937	1.293 32,8	.691 17,6	1.078 27,4	.425 10,8	.280 7,1	.183 4,6	.930 23,6	.240 6,1	117 @ 100MHz
CF28B0984	1.360 34,5	.547 13,9	1.145 29,1	.525 13,3	.280 7,1	.183 4,6	.867 22,0	.240 6,1	62 @ 100MHz



cable snap

WITH ADHESIVE MOUNTING BASE. Ferrite assembly in fully enclosed nylon case; various sizes are functional with wires and cables up to a .520" (13,2mm) diameter. After closing around wire and clasping shut, assembly is snap-fitted into its mounting base. May be installed in its intended location before or after product assembly simply by removing protective paper strip from base and pressing into place.

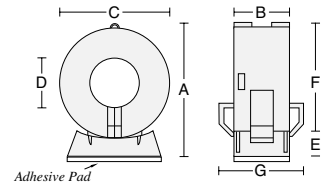

PART No.	A	B	C	D	E	F	G	IMPEDANCE IN OHMS
CA28B0642	.995 25,2	.708 18,0	.780 19,8	.300 7,6	.177 4,5	.818 20,8	1.000 25,4	100 @ 100MHz
CA28B0805	1.180 30,0	.476 12,1	.965 24,5	.345 8,8	.177 4,5	1.003 25,5	.890 22,6	73 @ 100MHz
CA28B0937	1.293 32,8	.691 17,6	1.078 27,4	.425 10,8	.177 4,5	1.116 28,3	.930 23,6	117 @ 100MHz
CA28B0984	1.360 34,5	.547 13,9	1.145 29,1	.525 13,3	.177 4,5	1.183 30,0	.867 22,0	62 @ 100MHz



cable snap

WITH SCREW MOUNT BASE. Ferrite assembly in fully enclosed nylon case; various sizes are functional with wires and cables up to a .520" (13,2mm) diameter. Mounting base is pre-installed at the intended location with a screw through the .125" (3,2mm) diameter hole in the bottom. After closing around wire and clasping shut, assembly snap-fits into base.

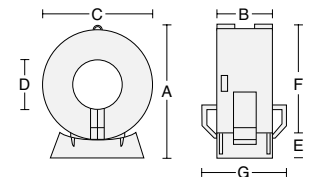

PART No.	A	B	C	D	E	F	G	IMPEDANCE IN OHMS
CW28B0642	.995 25,2	.708 18,0	.780 19,8	.300 7,6	.177 4,5	.818 20,8	1.000 25,4	100 @ 100MHz
CW28B0805	1.180 30,0	.476 12,1	.965 24,5	.345 8,8	.177 4,5	1.003 25,5	.890 22,6	73 @ 100MHz
CW28B0937	1.293 32,8	.691 17,6	1.078 27,4	.425 10,8	.177 4,5	1.116 28,3	.930 23,6	117 @ 100MHz
CW28B0984	1.360 34,5	.547 13,9	1.145 29,1	.525 13,3	.177 4,5	1.183 30,0	.867 22,0	62 @ 100MHz



cable clamp

Ferrite assembly bonded to nylon strap; functional with wires and cables up to a 1.00" (25,4 mm) diameter. Holes are provided for screw mounting.

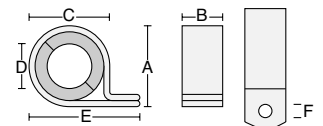

PART No.	A	B	C	D	E	F	IMPEDANCE IN OHMS
TC28B0550	.685 17,4	1.105 28,1	.685 17,4	.214 5,4	1.102 28,0	.195 5,0	281 @ 100MHz
TC28B0617	.740 18,8	1.125 28,6	.740 18,8	.276 7,0	1.215 30,9	.195 5,0	273 @ 100MHz
TC28B0642	.785 19,9	.630 16,0	.785 19,9	.320 8,1	1.335 33,9	.195 5,0	100 @ 100MHz
TC28B0805	.948 24,1	.500 12,7	.948 24,1	.404 10,3	1.498 38,0	.195 5,0	73 @ 100MHz
TC28B0937	1.127 28,6	.551 14,0	1.127 28,6	.449 11,4	1.677 42,6	.195 5,0	117 @ 100MHz
TC28B1123	1.320 33,5	1.125 28,6	1.320 33,5	.543 13,8	2.000 50,8	.195 5,0	220 @ 100MHz
TC28B0984	1.127 28,6	.500 12,7	1.127 28,6	.591 15,0	1.677 42,6	.195 5,0	62 @ 100MHz
TC28B1251	1.375 34,9	.875 22,2	1.375 34,9	.750 19,1	1.884 47,9	.195 5,0	138 @ 100MHz
TC28B1501	1.628 41,4	1.000 25,4	1.628 41,4	.750 19,1	2.150 55,5	.195 5,0	177 @ 100MHz
TC28B1500	1.628 41,4	1.000 25,4	1.628 41,4	1.000 25,4	2.150 55,5	.195 5,0	133 @ 100MHz
TC28B2000	2.125 54,0	1.500 38,1	2.125 54,0	1.000 25,4	2.860 72,6	.281 7,1	380 @ 100MHz



sleeve snap

Box-shaped ferrite assembly in enclosed nylon case. Various sizes are functional with wires up to .500" (12,7 mm) diameter. Simply clamp around cable or wire; plastic tabs at entry/exit ports apply pressure to cable surface to maintain mounting position. Options include foam adhesive pad on bottom.

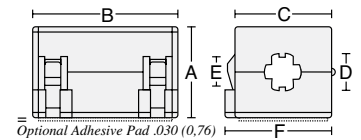

Available in standard colors gray (i.e., SS28B2031) and black (i.e., SS28B2031K)

Patent No. 5,764,125

PART No.	w/ Adhesive	A	B	C	D	E	F	IMPEDANCE IN OHMS
SS28B2027	AS28B2027	.420 10,7	.468 11,9	.468 11,9	.106 2,7	.072 1,8	.468 11,9	105 @ 100MHz
SS28B2031	AS28B2031	.700 17,8	1.255 31,9	.675 17,1	.230 5,8	.187 4,7	.768 19,5	200 @ 100MHz
SS28B2030	AS28B2030	.790 20,1	1.265 32,1	.770 19,6	.270 6,9	.220 5,6	.885 22,5	200 @ 100MHz
SS28B2033	AS28B2033	.790 20,1	1.265 32,1	.770 19,6	.350 8,8	.290 7,4	.885 22,5	200 @ 100MHz
SS28B2036	AS28B2036	1.155 29,3	1.250 31,8	1.125 28,6	.415 10,5	.350 8,9	1.230 31,2	230 @ 100MHz
SS28B2041	AS28B2041	.965 24,5	1.285 32,6	.930 23,6	.450 11,4	.380 9,7	1.035 26,3	238 @ 100MHz
SS28B2040	AS28B2040	1.155 29,3	1.250 31,8	1.125 28,6	.550 14,0	.480 12,2	1.230 31,2	230 @ 100MHz



sleeve snap for cable bundles

Box-shaped ferrite assembly for cable bundle diameters up to .730" (18,5mm) diameter. Allows single location for RFI suppression for multiple cables. Each circuit reacts separately with the suppression material without saturation. Alternatively, multiple turns of a single cable greatly increases impedance depending on frequency - see page 6, figures 3 and 4. Optional adhesive mount base.

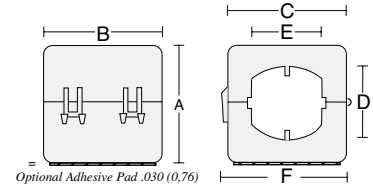

For optional variable diameter end port version with flexible spring flutes, see part numbers SS28B2044 and AS28B2044 in the photo below.

SS28B2035 available in standard colors gray (SS28B2035) and black (SS28B2035K)

PART No.	w/ Adhesive	A	B	C	D	E	F	IMPEDANCE IN OHMS
SS28B2035	AS28B2035	1.155 29,3	1.250 31,8	1.125 28,6	.790 20,1	.720 18,3	1.230 31,2	129 @ 100MHz
SS28B2043	AS28B2043	1.700 43,2	1.780 45,2	1.800 45,7	.790 20,1	.720 18,3	1.830 46,5	260 @ 100MHz



sleeve snap

WITH VARIABLE DIAMETER END PORTS. Box-shaped ferrite assembly in fully enclosed nylon case. End ports are surrounded with flexible spring flutes to grip a range of cable diameters from .125" to .730" (3,2 to 18,5 mm). Special mounting options include foam adhesive pad on bottom.

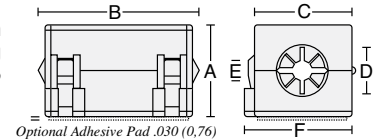

Available in standard colors gray (i.e., SS28B2034) and black (i.e., SS28B2034K)

Patent No. 5,003,278 and Patent No. 5,764,125

PART No.	w/ Adhesive	A	B (ref.)	C	D	E	F	IMPEDANCE IN OHMS
SS28B2034	AS28B2034	.585 14,9	1.250 31,8	.585 14,9	.250 6,4	.120 3,0	.680 17,3	220 @ 100MHz
SS28B2037	AS28B2037	.790 20,1	1.450 36,8	.770 19,6	.350 8,8	.200 5,1	.885 22,5	200 @ 100MHz
SS28B2042	AS28B2042	.965 24,5	1.480 37,6	.930 23,6	.425 10,8	.170 4,3	1.035 26,3	238 @ 100MHz
SS28B2032	AS28B2032	1.155 29,3	1.450 36,8	1.125 28,6	.500 12,7	.200 5,1	1.230 31,2	230 @ 100MHz
SS28B2044	AS28B2044	1.700 43,2	1.800 45,7	1.800 45,7	.790 20,1	.200 5,1	1.830 46,5	260 @ 100MHz



internal locking snap

WITH SECURE INTERNAL LOCKING SYSTEM. Cannot be reopened after snapping closed into position. Ensures that suppressor cannot be removed. Grip-lock tabs at entry/exit ports prevent longitudinal slippage on a range of cable diameters from .275" to .300" (7,0 to 7,6mm). Standard colors are computer gray (PMS#413), computer beige (PMS#468), black and natural white. A cost-effective alternative to over-molding.

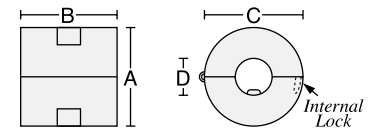

Patent Nos. 5,003,278, 5,162,772 and 5,764,125

PART No.	A	B (ref.)	C	D	COLOR	IMPEDANCE IN OHMS
IL28B0642W	.780 19,8	.780 19,8	.780 19,8	.316 8,0	NATURAL WHITE	100 @ 100MHz
IL28B0642G	.780 19,8	.780 19,8	.780 19,8	.316 8,0	COMPUTER GRAY	100 @ 100MHz
IL28B0642B	.780 19,8	.780 19,8	.780 19,8	.316 8,0	COMPUTER BEIGE	100 @ 100MHz
IL28B0642K	.780 19,8	.780 19,8	.780 19,8	.316 8,0	BLACK	100 @ 100MHz

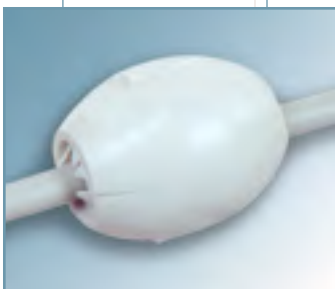

jelly bean snap

MINIATURE SIZE WITH INTERNAL LOCKING SYSTEM. Cannot be reopened after snapping closed into position. Ensures that suppressor cannot be removed. Grip-lock tabs at entry/exit ports prevent longitudinal slippage on a range of cable diameters from .060" to .120" (1,5 to 3,0mm).

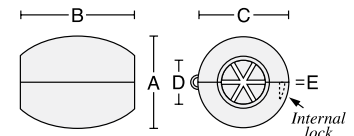

Excellent for tight spaces and low profile applications. A cost-effective alternative to "molded-in" suppressors, shrink tubing, tie wraps, taping and other secondary installation operations.

Available in standard color gray

Patent Nos. 5,003,278, 5,162,772 and 5,764,125

PART No.	A	B	C	D	E	IMPEDANCE IN OHMS
JB28B0010	.670 17,0	.820 20,8	.670 17,0	.290 7,4	.055 1,4	160 @ 100MHz

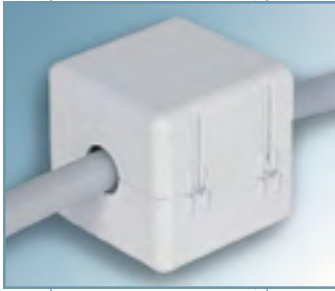

high impedance sleeve snap

WITH OPTIONAL MOUNTING BASES.

High impedance ferrite assembly for large scale applications containing high data rates and microprocessor harmonics/spurious signals well beyond the operating frequency. Excellent for telecommunications switching applications, local area networks (LANs) and distribution system integration. The basic version simply clamps into position around cables and wiring. May also be mounted with a flat-head screw through the .120" (3,0mm) diameter hole in the bottom by temporarily removing lower ferrite half.

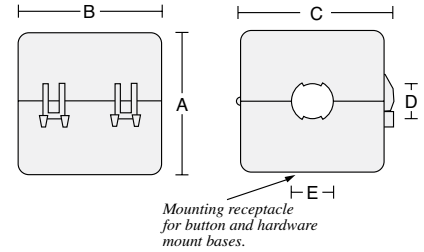

Other mounting options include a foam adhesive base, a button mount base sized for a .150" (3.8 mm) diameter hole, and a hardware mounting plate for screw or rivet attachment. The adhesive mount base and button mount base options are preassembled. The hardware mounting base may be press-fitted into the receptacle on the bottom of the case during installation in one of four positions at 90° increments for alternative assembly configurations.

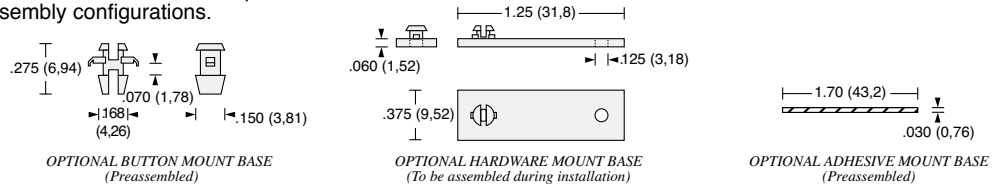

PART No.	Description	A	B	C	D	E	IMPEDANCE IN OHMS	
HI28B2038	Basic	1.700	43,2	1.780	45,2	1.800	45,7 .428 10,9 .468 11,9	410 @ 100MHz
HF28B2038	Button Mount	1.700	43,2	1.780	45,2	1.800	45,7 .428 10,9 .468 11,9	410 @ 100MHz
HW28B2038	Hardware Mount	1.700	43,2	1.780	45,2	1.800	45,7 .428 10,9 .468 11,9	410 @ 100MHz
HA28B2038	Adhesive Mount	1.700	43,2	1.780	45,2	1.800	45,7 .428 10,9 .468 11,9	410 @ 100MHz

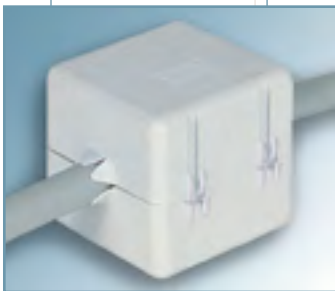

high impedance sleeve snap

WITH VARIABLE DIAMETER END PORTS AND OPTIONAL MOUNTING BASES.

High impedance ferrite assembly with exactly the same characteristics as the high impedance sleeve snaps above, except that the entry/exit end ports are surrounded with flexible spring flutes to grip a range of cable diameters from .250" to .435" (6,4 to 11,0mm). Excellent for telecommunications switching applications, local area networks (LANs) and distribution system integration. The basic version simply clamps into position around cables and wiring. May also be mounted with a flat-head screw through the .120" (3,0mm) diameter hole in the bottom by temporarily removing lower ferrite half.

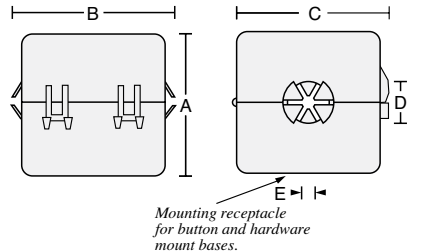

Other mounting options include a foam adhesive base, a button mount base sized for a .150" (3.8mm) diameter hole, and a hardware mounting plate for screw or rivet attachment. The adhesive mount base and button mount base options are preassembled. The hardware mounting base may be press-fitted into the receptacle on the bottom of the case during installation in one of four positions at 90° increments for alternative assembly configurations.

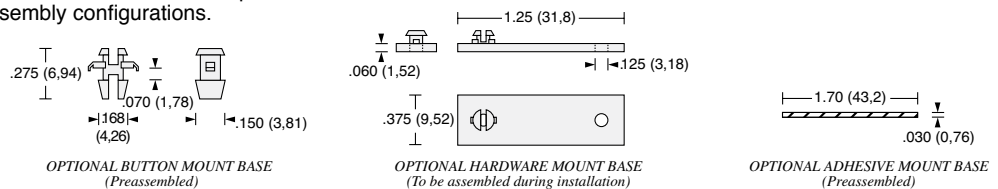

PART No.	Description	A	B (ref.)	C	D	E	IMPEDANCE IN OHMS	
HI28B2039	Basic	1.700	43,2	2.000	50,8	1.800	45,7 .500 12,7 .140 3,55	410 @ 100MHz
HF28B2039	Button Mount	1.700	43,2	2.000	50,8	1.800	45,7 .500 12,7 .140 3,55	410 @ 100MHz
HW28B2039	Hardware Mount	1.700	43,2	2.000	50,8	1.800	45,7 .500 12,7 .140 3,55	410 @ 100MHz
HA28B2039	Adhesive Mount	1.700	43,2	2.000	50,8	1.800	45,7 .500 12,7 .140 3,55	410 @ 100MHz



USB cable sleeve snap

WITH VARIABLE DIAMETER END PORTS. Specifically sized to fit the range of common USB I/O cable diameters; variable diameter end ports allow for different types of cable insulation covers measuring .125" to .179" (3,0 - 4,5mm).

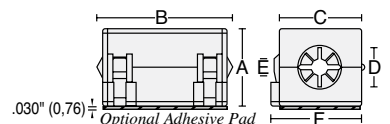

Simple snap-on installation. Available with optional adhesive pad on bottom, and in standard gray (PMS #413) and black colors.

For use with USB I/O USB 2.0 Electrical Test Specification, sections 7.0 and 8.0

PART No.	w/Adhesive	A	B	C	D	E	F	COLOR	IMPEDANCE IN OHMS
USB28B2034	USB28B2034A	.585	14,9	1.250	31,8	.585	14,9 .250 6,4 .120 3,0 .680 17,3	gray	220 @ 100MHz
USB28B2034K	USB28B2034KA	.585	14,9	1.250	31,8	.585	14,9 .250 6,4 .120 3,0 .680 17,3	black	220 @ 100MHz



telecom cable snaps

WITH END PORTS FOR FLAT-OVAL CABLES. Box-shaped ferrite assembly in fully enclosed nylon case. Two sizes: one for 4-conductor and one for 6-conductor standard telecom flat-oval cable. Clamps around cable with appropriate pressure to maintain desired position.

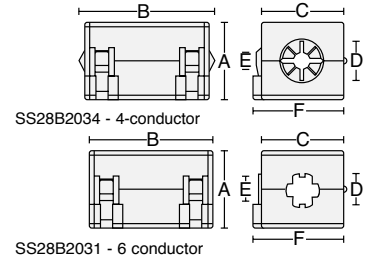

Available in standard colors gray (i.e., SS28B2034) and black (i.e., SS28B2034K)
Patent Nos. 5,003,278 and 5,764,125

PART No.	Cable Size	A	B	C	D	E	F	IMPEDANCE IN OHMS
SS28B2034	4 conductor	.585	14,9	1.250	31,8	.585	14,9	.250 6,4 .120 3,0 .680 17,3 220 @ 100MHz
SS28B2031	6 conductor	.700	17,8	1.255	31,9	.675	17,1	.230 5,8 .187 4,7 .768 19,5 200 @ 100MHz



very high impedance multi-turn sleeve snap

WITH SERPENTINE CABLE THREADING CAPABILITY.

By increasing the number of times the circuit passes through the ferrite core, the effective magnetic path is lengthened yielding a significant increase in impedance. See page 6, figures 3 and 4. The gain is equal to N^2 , the square of the number of turns, and depending on the circuit cable load and frequencies involved, much of the increase can be realized.

Cables may be "looped back through" as shown at left; or, "looped over the top" as shown at left (insert).

In an alternate configuration, separate cable circuits can be accommodated without saturation. Three styles permit different approaches:

The 1-hole allows two passes of a cable with a diameter up to .365" (9,3mm) or three passes of a cable with a diameter up to .243" (6,2mm).

The 2-hole allows two passes of a cable with a diameter up to .335" (8,5mm).

The 3-hole allows three passes of cable with a diameter up to .203" (5,8mm).

Each is available with an optional adhesive foam pad mounting base.

Available in standard colors gray (i.e., SS28B2035) and black (i.e., SS28B2035K)
Patent No. 5,003,278

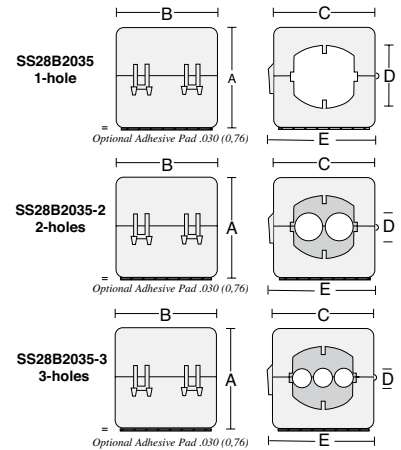

PART No.	w/Adhesive	Description	A	B	C	D	E	IMPEDANCE IN OHMS ref.
SS28B2035	AS28B2035	1-hole	1.155	29,3	1.250	31,8	1.125 28,6 .780 19,8 1.230 31,2	1N=129* 2N=2 ² =4NΩ ref.
SS28B2035-2	AS28B2035-2	2-hole	1.155	29,3	1.250	31,8	1.125 28,6 .335 8,5 1.230 31,2	1N=270* 3N=3 ² =9NΩ ref.
SS28B2035-3	AS28B2035-3	3-hole	1.155	29,3	1.250	31,8	1.125 28,6 .203 5,2 1.230 31,2	1N=340* depending on circuit load and frequency

* @ 100 MHz



cable bundle clamp

WITH UNIVERSAL MOUNTING STRAP. For cable bundle diameters up to 1.00" (25,4mm). Allows single location for RFI suppression for multiple cables and wiring runs. Each circuit reacts independently with the suppression material without saturation. Adhesive mount base also provides a centered .203" (5,1mm) diameter hole for optional hardware attachment. Quick-release closure clip allows easy addition or removal of wires.

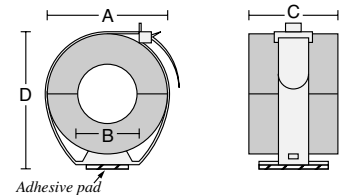

PART No.	w/ adhesive	A	B	C	D	IMPEDANCE IN OHMS
BC28B1251	BA28B1251	1.38	35,1	.75	19,1	.875 22,2 1.71 41,7 138 @ 100MHz
BC28B1501	BA28B1501	1.63	41,4	.75	19,1	1.000 25,4 1.96 48,0 177 @ 100MHz
BC28B1500	BA28B1500	1.63	41,4	1.00	25,4	1.000 25,4 1.96 48,0 133 @ 100MHz



pre-molded sleeve

WITH INTERNAL FRICTION GRIP Exterior PVC sheath pre-molded over ferrite suppressor. Assembles to cable prior to termination by threading in one end and out the other. Neutral gray standard color. Five sizes accommodate cable diameters from .200" to .430" (5,1 to 10,9mm). The preferred alternative to cable over-molding, shrink tubing, taping, tie wraps and other costly secondary installation operations. A drop of water in the I.D. during assembly will facilitate sliding into position.

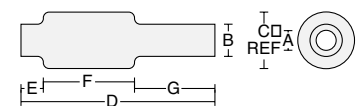

Patent No. 5,200,730

PART No.	A	B	C	D	E	F	G	IMPEDANCE IN OHMS
PM28B3375	.192	4,8	.290	7,4	.465	11,8	2.01 51,1 .250 6,4 .960 24,4 .800 20,3	140 @ 100MHz
PM28B0625	.310	7,9	.400	10,2	.715	18,2	1.82 46,2 .250 6,4 .772 19,6 .800 20,3	120 @ 100MHz
PM28B1625	.310	7,9	.400	10,2	.715	18,2	2.38 60,5 .250 6,4 1.335 33,9 .800 20,3	225 @ 100MHz
PM28B0686	.375	9,5	.465	11,8	.776	19,7	2.38 60,5 .250 6,4 1.335 33,9 .800 20,3	196 @ 100MHz
PM28B0736	.430	10,9	.520	13,2	.776	19,7	2.38 60,5 .250 6,4 1.335 33,9 .800 20,3	176 @ 100MHz

special purpose shielding bar

For situations where extremely high amounts of attenuation are needed and/or multiple passes through a traditional ferrite I.D. are not practical or sufficient. Simply wrap cable in a spiral around bar for optimum absorption.

- One individual size fits most applications
- For round or flat cables wound axially or attached longitudinally
- Attachment with cable ties or optional adhesive pad
- Sandwiching cable between two bars provides up to three times the impedance of a single bar depending on frequency

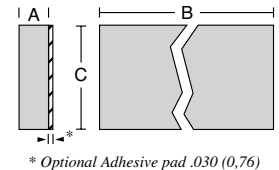

PART No.	w/ adhesive	A	B	C	IMPEDANCE IN OHMS
SB28B5630	SB28B5630A	.365	9,3	5.630 143,0	1.00 25,4 one pass: 500 @ 100MHz

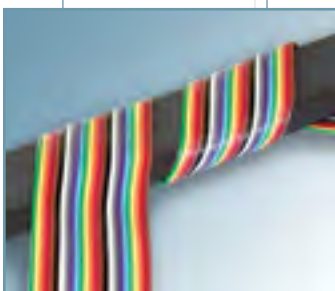

miniature beads

Very small cylindrical suppressors for wire diameters below .25" (6,4mm). Handy for tight spaces, on-board suppression and general applications.



PART No.	A		B		C		IMPEDANCE IN OHMS
28B0137-3	.500	12,7	.138	3,5	.051	1,3	153 @ 100MHz
28B0138-7	.550	14,0	.138	3,5	.034	0,9	234 @ 100MHz
28B0200-4	.900	22,9	.200	5,1	.062	1,6	318 @ 100MHz
28B0250-1	.625	15,9	.250	6,4	.125	3,2	133 @ 100MHz
28B0300-0	.200	5,1	.300	7,6	.069	1,8	93 @ 100MHz
28B0385-2	.650	16,5	.385	9,8	.038	0,9	452 @ 100MHz
28B0350-0	.625	15,9	.343	8,7	.170	4,3	102 @ 100MHz
28B0355-0	.354	9,0	.787	20,0	.187	4,7	138 @ 100MHz
28B0375-3	.750	19,1	.375	9,5	.192	4,8	140 @ 100MHz
28B0562-2	1.125	28,6	.562	14,2	.250	6,4	257 @ 100MHz

large beads

Sizes up to 1.0" I.D. (25,4 mm) for applications where there are large cable bundles or where great amounts of suppression are required.

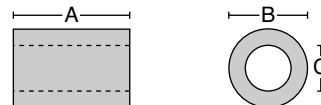

PART No.	A		B		C		IMPEDANCE IN OHMS
28B0563-0	.600	15,2	.562	14,2	.286	7,3	124 @ 100MHz
28B0625-0	.562	14,3	.625	15,9	.310	7,9	120 @ 100MHz
28B0625-1	1.125	28,6	.625	15,9	.310	7,9	225 @ 100MHz
28B0626-0	.625	15,9	.626	16,0	.133	3,4	300 @ 100MHz
28B0672-0	.672	17,1	1.000	25,4	.345	8,6	182 @ 100MHz
28B0672-1	1.000	25,4	.672	17,1	.345	8,6	182 @ 100MHz
28B0686-2	1.125	28,6	.686	17,4	.375	9,5	196 @ 100MHz
28B0735-0	1.125	28,6	.735	18,7	.400	10,2	188 @ 100MHz
28B0736-0	1.125	28,6	.736	18,7	.430	10,9	176 @ 100MHz
28B1020-1	1.125	28,6	1.020	25,9	.505	12,8	225 @ 100MHz
28B1102-1	1.000	25,4	1.102	27,9	.620	15,7	147 @ 100MHz
28B1250-2	1.000	25,4	1.250	31,8	.750	19,1	151 @ 100MHz
28B1387-1	1.000	25,4	1.387	35,2	.882	22,4	142 @ 100MHz
28B2000-3	2.000	50,8	2.000	50,8	1.000	25,4	381 @ 100MHz

toroids

Cables can many times be assembled through the larger center opening even with connectors and plugs installed beforehand. Multiple cable turns through the center yield greater suppression and the flexibility to fine-tune a circuit. Up to 1.400" (35,6mm) I.D.

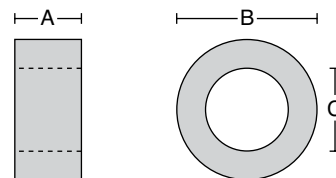

PART No.	A		B		C		IMPEDANCE IN OHMS
28B0870-0	.250	6,4	.870	22,1	.540	13,7	One Pass 25 @ 100MHz
28B0999-0	.500	12,7	1.000	25,4	.610	15,5	One Pass 83 @ 100MHz
28B1225-0	.612	15,5	1.225	31,1	.750	19,1	One Pass 97 @ 100MHz
28B1417-2	.500	12,7	1.417	36,0	.905	23,0	One Pass 89 @ 100MHz
28B2400-0	.500	12,7	2.400	61,0	1.400	35,6	One Pass 88 @ 100MHz

extra large toroids

WITH INSIDE DIAMETERS FROM 1.33" TO 6.66" (33.8 to 167 mm). Very large toroids for special purpose applications available in #28 material as shown below, and in #25 material.

Special order only; available by quotation. Please contact customer service with quantity information. Some items in stock.

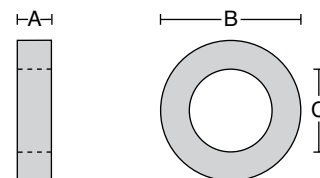

PART No.	A		B		C		IMPEDANCE IN OHMS
28B2275	.500	12,7	2.275	57,8	1.335	33,9	Per Application
28B2945	.500	12,7	2.945	74,8	1.775	45,1	Per Application
28B3170	.500	12,7	3.170	80,5	1.645	41,8	Per Application
28B4100	.500	12,7	4.100	104,1	2.650	67,3	Per Application
28B5945	.500	12,7	5.885	149,4	4.275	108,6	Per Application
28B5950	.500	12,7	5.885	149,4	3.675	93,3	Per Application
28B9210	1.000	25,4	9.210	233,9	6.665	169,3	Per Application

square tiles

For purpose-built electronic enclosures and architectural full room lining, these designs permit optimum absorption with minimum reflection. Very effective when used just in the corners of shielded rooms to dampen the effects of sharp corners.

Special order only; available by quotation. Please contact customer service with quantity information. Some items in stock.

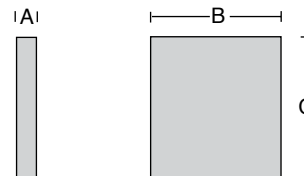

PART No.	A		B		C		IMPEDANCE IN OHMS
21T3350	.248	6,3	3.350	85,0	3.350	85,0	Per Application
21T3937	.248	6,3	3.937	100,0	3.937	100,0	Per Application
21T4335	.248	6,3	4.335	110,0	4.335	110,0	Per Application

flat cable clamp

WITH FULL OUTER ENCLOSURE. Ferrite assembly in fully enclosed nylon case. Four sizes functional with flat cables up to 64-conductor widths. Internal grip-lock tabs apply pressure on cable to maintain mounting position.

May also be mounted with flat-head screws through the .120" (3,0mm) diameter holes on 1.25" (31,8mm) centers in the bottom by temporarily removing the lower ferrite half. Excellent for flex-circuits.

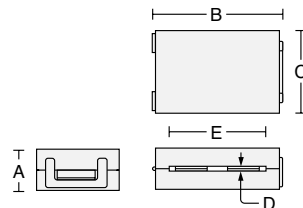

PART No.	A	B	C	D	E	IMPEDANCE IN OHMS	
RC28B1729	.670	17,0	2.03	51,6	1.312	33,3 .060 1,5 1.355 34,4	200 @ 100MHz
RC28B2480	.670	17,0	2.76	70,1	1.312	33,3 .060 1,5 2.047 52,0	250 @ 100MHz
RC28B3012	.670	17,0	3.26	82,8	1.312	33,3 .060 1,5 2.540 64,5	286 @ 100MHz
RC28B4340	.755	19,2	4.61	117,1	1.312	33,3 .104 2,6 3.240 82,3	325 @ 100MHz



flat cable clamp

WITH FULL OUTER ENCLOSURE AND ADHESIVE MOUNT. Ferrite assembly in fully enclosed nylon case. Four sizes functional with flat cables up to 64-conductor widths. Internal grip-lock tabs apply pressure on cable to maintain mounting position.

Installs easily on any mounting surface by removing liner from foam adhesive base pad. Excellent for flex-circuits.

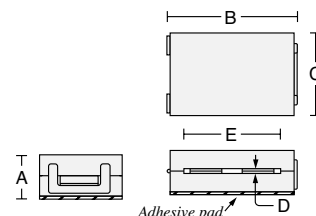

PART No.	A	B	C	D	E	IMPEDANCE IN OHMS	
RA28B1729	.700	17,8	2.03	51,6	1.312	33,3 .060 1,5 1.355 34,4	200 @ 100MHz
RA28B2480	.700	17,8	2.76	70,1	1.312	33,3 .060 1,5 2.047 52,0	250 @ 100MHz
RA28B3012	.700	17,8	3.26	82,8	1.312	33,3 .060 1,5 2.540 64,5	286 @ 100MHz
RA28B4340	.785	19,9	4.61	117,1	1.312	33,3 .104 2,6 3.240 82,3	325 @ 100MHz



low profile flat cable clamp

SLIM-LINE FLAT CABLE CLAMP WITH CABLE GRIP OPENINGS. Ferrite pair snaps together into the lowest profile nylon enclosure available. Three sizes accommodate flat cables up to 40-conductors. Internal grip-lock tabs maintain mounting position. Mounts also with flat-head screws through the .120" (3,0mm) diameter holes in the bottom by temporarily removing the lower ferrite half.

Excellent for flex-circuits.

1. Place cable over lower half.
2. Align tabs and pockets on one end.
3. Rotate top half onto bottom clipping both sides in one smooth motion.

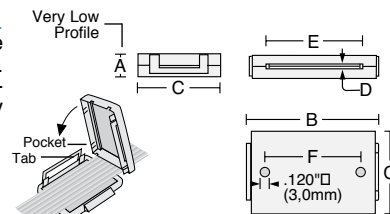

PART No.	A	B	C	D	E	F	IMPEDANCE IN OHMS
RC28B0765	.370	9,4	1.065	27,1	1.312	33,3 .038 0,97 .547 13,9 .250 6,4	142 @ 100MHz
RC28B1265	.370	9,4	1.560	39,6	1.312	33,3 .038 0,97 1.047 26,6 .750 19,1	148 @ 100MHz
RC28B2265	.370	9,4	2.560	65,0	1.312	33,3 .038 0,97 2.047 52,0 1.750 44,5	154 @ 100MHz



low profile flat cable clamp

SLIM-LINE FLAT CABLE CLAMP WITH CABLE GRIP OPENINGS AND ADHESIVE MOUNT. Ferrite pair snaps together into the lowest profile nylon enclosure available. Three sizes accommodate flat cables up to 40-conductors. Internal grip-lock tabs apply pressure on cable to maintain mounting position. Installs easily on any mounting surface by removing liner from foam adhesive base pad.

Excellent for flex-circuits.

1. Place cable over lower half.
2. Align tabs and pockets on one end.
3. Rotate top half onto bottom clipping both sides in one smooth motion.

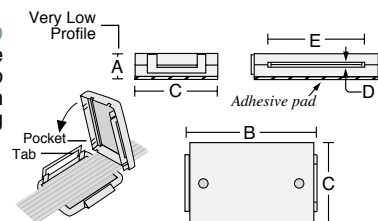

PART No.	A	B	C	D	E	IMPEDANCE IN OHMS	
RA28B0765	.400	10,2	1.065	27,1	1.312	33,3 .038 0,97 .547 13,9	142 @ 100MHz
RA28B1265	.400	10,2	1.560	39,6	1.312	33,3 .038 0,97 1.047 26,6	148 @ 100MHz
RA28B2265	.400	10,2	2.560	65,0	1.312	33,3 .038 0,97 2.047 52,0	154 @ 100MHz



flat cable clamp

WITH ADHESIVE MOUNT. Ferrite assembly bonded in nylon mounting clamp; easily installed by peeling protective paper strip from base and pressing into place. Nine sizes accommodate all flat cables up to 50-conductor width.

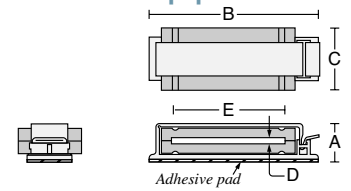

PART No.	w/o Adhesive	A	B	C	D	E	IMPEDANCE IN OHMS	
FA28B0071	FC28B0071	.520 13,2	1.244 31,6	.750 19,1	.060 1,5	.510 13,0	49 @ 100 MHz	
FA28B0121	FC28B0121	.520 13,2	1.790 45,5	.750 19,1	.060 1,5	1.010 25,7	97 @ 100 MHz	
FA28B1240	FC28B1240	.520 13,2	1.790 45,5	1.125 28,6	.040 1,0	1.020 25,9	250 @ 100MHz	
FA28B1265		.520 13,2	1.790 45,5	1.125 28,6	.038 1,0	1.047 26,6	148 @ 100MHz	
FA28B1729	FC28B1729	.800 20,3	2.430 61,7	1.125 28,6	.060 1,5	1.355 34,4	200 @ 100 MHz	
FA28B2265		.520 13,2	3.000 80,8	1.125 28,6	.038 1,0	2.047 52,0	154 @ 100 MHz	
FA28B2375	FC28B2375	.800 20,3	3.180 80,8	1.050 26,7	.060 1,5	1.720 43,7	195 @ 100 MHz	
FA28B2480	FC28B2480	.800 20,3	3.180 80,8	1.125 28,6	.060 1,5	2.047 52,0	250 @ 100 MHz	
FA28B3012	FC28B3012	.800 20,3	3.700 94,0	1.125 28,6	.060 1,5	2.540 64,5	286 @ 100 MHz	

flat cable clamp

WITH SINGLE PRESS FIT MOUNT. Ferrite assembly bonded in nylon mounting clamp; easily installed by pressing the integral spring tab fastener into a .250" (6,4mm) diameter hole. Seven sizes accommodate all flat cables up to 50-conductor width. Fits substrates up to .070" (1,8mm) thickness.

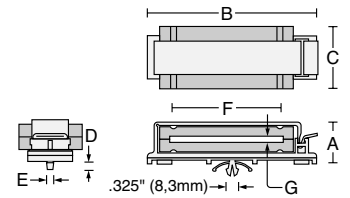

PART No.	A	B	C	D	E	F	G	IMPEDANCE IN OHMS
FF28B0121	.475 12,7	1.790 45,5	.750 19,1	.325 8,3	.240 6,1	1.010 25,7	.060 1,5	97 @ 100MHz
FF28B1240	.475 12,7	1.790 45,5	1.125 28,6	.325 8,3	.240 6,1	1.020 25,9	.040 1,0	250 @ 100MHz
FF28B1265	.475 12,7	1.790 45,5	1.125 28,6	.325 8,3	.240 6,1	1.047 26,6	.038 1,0	148 @ 100MHz
FF28B1729	.800 20,3	2.430 61,7	1.125 28,6	.280 7,1	.183 4,6	1.355 34,4	.060 1,5	200 @ 100MHz
FF28B2375	.800 20,3	3.180 80,8	1.050 26,7	.280 7,1	.183 4,6	1.720 43,7	.060 1,5	195 @ 100MHz
FF28B2480	.800 20,3	3.180 80,8	1.125 28,6	.280 7,1	.183 4,6	2.047 52,0	.060 1,5	250 @ 100MHz
FF28B3012	.800 20,3	3.700 94,0	1.125 28,6	.280 7,1	.183 4,6	2.540 64,5	.060 1,5	286 @ 100MHz

flat cable clamp

WITH DUAL PRESS FIT MOUNTS. Ferrite assembly bonded in nylon mounting clamp; easily installed by pressing the integral spring tab fasteners into two .219" (5,6mm) diameter holes. Three sizes accommodate all flat cables up to 50-conductor width. Fits substrates up to .070" (1,8mm) thickness.

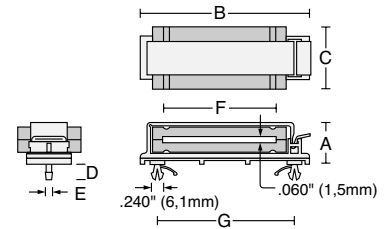

PART No.	A	B	C	D	E	F	G	IMPEDANCE IN OHMS
FD28B2375	.800 20,3	3.180 80,8	1.050 26,7	.280 7,1	.183 4,6	1.720 43,7	2.550 64,8	195 @ 100MHz
FD28B2480	.800 20,3	3.180 80,8	1.125 28,6	.280 7,1	.183 4,6	2.047 52,0	2.550 64,8	250 @ 100MHz
FD28B3012	.800 20,3	3.700 94,0	1.125 28,6	.280 7,1	.183 4,6	2.540 64,5	2.550 64,8	286 @ 100MHz

flat cable clamp

WITH SPLIT END CAPS, HARDWARE MOUNT. Ferrite assembly press-fitted into a pair of nylon end caps. Mounts using screws, push-rivets, or other hardware. Ten sizes accommodate flat cables up to 64-conductor width.

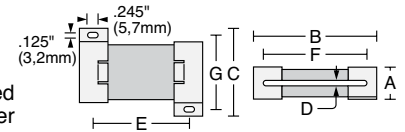

PART No.	A	B	C	D	E	F	G	IMPEDANCE IN OHMS
SE28B0071	.375 9,5	.815 20,7	1.190 30,2	.060 1,5	.470 11,9	.510 13,0	.900 22,9	49 @ 100MHz
SE28B0121	.375 9,5	1.315 33,4	1.190 30,2	.060 1,5	1.000 25,4	1.000 25,7	.900 22,9	97 @ 100MHz
SE28B0146	.375 9,5	1.565 39,8	1.190 30,2	.060 1,5	1.250 31,8	1.260 32,0	.900 22,9	120 @ 100MHz
SE28B0221	.375 9,5	2.315 58,8	1.190 30,2	.060 1,5	2.000 50,8	2.010 51,1	.900 22,9	176 @ 100MHz
SE28B1240	.625 15,9	1.365 34,7	1.829 46,5	.040 1,0	.725 18,4	1.020 25,9	1.500 38,1	250 @ 100MHz
SE28B1729	.625 15,9	1.849 47,0	1.829 46,5	.060 1,5	1.300 33,0	1.355 34,4	1.500 38,1	200 @ 100MHz
SE28B2480	.625 15,9	2.570 65,3	1.829 46,5	.060 1,5	2.000 50,8	2.047 52,0	1.500 38,1	250 @ 100MHz
SE28B3012	.625 15,9	3.125 79,4	1.829 46,5	.060 1,5	2.550 64,8	2.540 64,5	1.500 38,1	286 @ 100MHz
SE28B3500	.625 15,9	3.620 91,9	1.829 46,5	.060 1,5	3.020 76,7	3.000 76,2	1.500 38,1	290 @ 100MHz
SE28B4340	.625 15,9	4.460 113,3	1.829 46,5	.104 2,6	3.875 98,4	3.240 82,3	1.500 38,1	325 @ 100MHz

flat cable clamp

WITH SPLIT END CAPS, ADHESIVE MOUNT. Ferrite assembly press-fitted into a pair of nylon end caps with adhesive foam mounting pads. Ten sizes accommodate flat cables up to 64-conductor width.

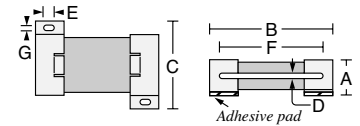

PART No.	A	B	C	D	E	F	G	IMPEDANCE IN OHMS
SA28B0071	.405 10,3	.815 20,7	1.190 30,2	.060 1,5	.245 5,7	.510 13,0	.125 3,2	49 @ 100MHz
SA28B0121	.405 10,3	1.315 33,4	1.190 30,2	.060 1,5	.245 5,7	1.010 25,7	.125 3,2	97 @ 100MHz
SA28B0146	.405 10,3	1.565 39,8	1.190 30,2	.060 1,5	.245 5,7	1.260 32,0	.125 3,2	120 @ 100MHz
SA28B0221	.405 10,3	2.315 58,8	1.190 30,2	.060 1,5	.245 5,7	2.010 51,1	.125 3,2	176 @ 100MHz
SA28B1240	.655 16,6	1.365 34,7	1.829 46,5	.040 1,0	.245 5,7	1.020 25,9	.125 3,2	250 @ 100MHz
SA28B1729	.655 16,6	1.849 47,0	1.829 46,5	.060 1,5	.245 5,7	1.355 34,4	.125 3,2	200 @ 100MHz
SA28B2480	.655 16,6	2.570 65,3	1.829 46,5	.060 1,5	.245 5,7	2.047 52,0	.125 3,2	250 @ 100MHz
SA28B3012	.655 16,6	3.125 79,4	1.829 46,5	.060 1,5	.245 5,7	2.540 64,5	.125 3,2	286 @ 100MHz
SA28B3500	.655 16,6	3.620 91,9	1.829 46,5	.060 1,5	.245 5,7	3.000 76,2	.125 3,2	290 @ 100MHz
SA28B4340	.655 16,6	4.460 113,3	1.829 46,5	.104 2,6	.245 5,7	3.240 82,3	.125 3,2	325 @ 100MHz

high impedance flat cable clamp

WITH ADHESIVE MOUNT. Extra wide ferrite assembly greatly increases effective magnetic path. Bonded in nylon mounting clamp; easily installed by peeling protective paper strip from base and pressing into place. Three sizes accommodate all flat cables up to 50-conductor width.



PART No.	w/o Adhesive	A	B	C	D	E	IMPEDANCE IN OHMS	
FA28B1785	FC28B1785	.800 20,3	2.430 61,7	1.500 38,1	.060 1,5	1.355 34,4	260 @ 100MHz	
FA28B2500	FC28B2500	.800 20,3	3.180 80,8	1.500 38,1	.060 1,5	2.047 52,0	325 @ 100MHz	
FA28B3000	FC28B3000	.800 20,3	3.700 94,0	1.500 38,1	.060 1,5	2.540 64,5	370 @ 100MHz	

high impedance flat cable clamp

WITH SINGLE PRESS FIT MOUNT. Extra wide ferrite assembly greatly increases effective magnetic path. Bonded in nylon mounting clamp; easily installed by pressing the integral spring tab fastener into a .250" (6,4mm) diameter hole. Three sizes accommodate all flat cables up to 50-conductor width. Fits substrates up to .070" (1,8mm) thickness.



PART No.	A	B	C	D	E	F	G	IMPEDANCE IN OHMS	
FF28B1785	.800 20,3	2.430 61,7	1.500 38,1	.280 7,1	.183 4,6	1.355 34,4	.060 1,5	260 @ 100MHz	
FF28B2500	.800 20,3	3.180 80,8	1.500 38,1	.280 7,1	.183 4,6	2.047 52,0	.060 1,5	325 @ 100MHz	
FF28B3000	.800 20,3	3.700 94,0	1.500 38,1	.280 7,1	.183 4,6	2.540 64,5	.060 1,5	370 @ 100MHz	

high impedance flat cable clamp

WITH DUAL PRESS FIT MOUNTS. Extra wide ferrite assembly greatly increases effective magnetic path. Bonded in nylon mounting clamp; easily installed by pressing the integral spring tab fasteners into two .219" (5,6mm) diameter holes. Two sizes accommodate all flat cables up to 50-conductor width. Fits substrates up to .070" (1,8mm) thickness.



PART No.	A	B	C	D	E	F	G	IMPEDANCE IN OHMS	
FD28B2500	.800 20,3	3.180 80,8	1.500 38,1	.280 7,1	.183 4,6	2.047 52,0	2.550 64,8	325 @ 100MHz	
FD28B3000	.800 20,3	3.700 94,0	1.500 38,1	.280 7,1	.183 4,6	2.540 64,5	2.550 64,8	370 @ 100MHz	

high impedance flat cable sleeve clamp

WITH 15-CONDUCTOR FLAT CABLE OPENING. Uniquely accommodates flat cables up to 15-conductors through the horizontal opening with substantially more impedance than standard flat clamps used typically for this type of application.

Available with optional adhesive foam mounting pad base.

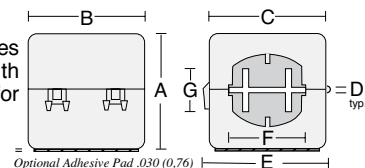

Available in standard colors gray (SS28B2035-15) and black (SS28B2035-15K) Patent No. 5,003,278

PART No.	w/ Adhesive Pad	A	B	C	D	E	F	IMPEDANCE IN OHMS	
SS28B2035-15	AS28B2035-15	1.16 29,4	1.25 31,8	1.125 28,6	.038 1,1	1.230 35,1	.755 21,6	270 @ 100MHz	



low profile solids

ULTRA-THIN. Excellent for thin flex circuits and SCSI 2 flat cables on .025" (0,64mm) centers. Six sizes accommodate cable widths up to 2.00" (50,8 mm).

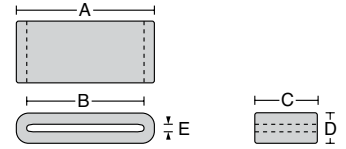

PART No.	A		B		C		D		E		IMPEDANCE IN OHMS
28R0760	.760	19,3	.510	13,0	1.125	28,6	.300	7,6	.051	1,3	150 @ 100MHz
28R1127	1.125	28,6	.925	23,5	1.220	31,0	.303	7,7	.066	1,7	188 @ 100MHz
28R1127-2	1.125	28,6	.925	23,5	.980	24,9	.303	7,7	.066	1,7	151 @ 100MHz
28R1260	1.260	32,0	1.010	25,7	1.125	28,6	.300	7,6	.051	1,3	237 @ 100MHz
28R1575	1.575	40,0	1.325	33,7	1.125	28,6	.300	7,6	.051	1,3	160 @ 100MHz
28R1953	1.953	49,6	1.732	44,0	.472	12,0	.288	7,3	.059	1,5	109 @ 100MHz
28R2300	2.300	58,4	2.050	52,1	1.125	28,6	.300	7,6	.051	1,3	245 @ 100MHz

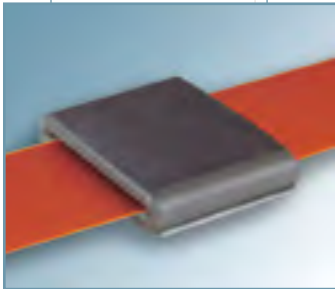

low profile solids

ULTRA-THIN WITH SHOCK MOUNT ADHESIVE FOAM BASE. Excellent for thin flex circuits and SCSI 2 flat cables on .025" (0,64mm) centers. Six sizes accommodate cable widths up to 2.00" (50,8mm). High tack adhesive mounting pad secures to almost any surface. Can be stacked one on top of another.

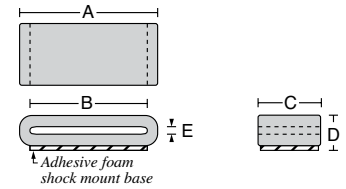

PART No.	A		B		C		D		E		IMPEDANCE IN OHMS
SM28R0760	.760	19,3	.510	13,0	1.125	28,6	.330	8,4	.051	1,3	150 @ 100MHz
SM28R1127	1.125	28,6	.925	23,5	1.220	31,0	.333	8,5	.066	1,7	188 @ 100MHz
SM28R1127-2	1.125	28,6	.925	23,5	.980	24,9	.303	8,5	.066	1,7	151 @ 100MHz
SM28R1260	1.260	32,0	1.010	25,7	1.125	28,6	.330	8,4	.051	1,3	237 @ 100MHz
SM28R1575	1.575	40,0	1.325	33,7	1.125	28,6	.330	8,4	.051	1,3	160 @ 100MHz
SM28R1953	1.953	49,6	1.732	44,0	.472	12,0	.318	8,1	.059	1,5	109 @ 100MHz
SM28R2300	2.300	58,4	2.050	52,1	1.125	28,6	.330	8,4	.051	1,3	245 @ 100MHz



flex-circuit low profile solids

ULTRA-THIN WITH OPTIONAL ADHESIVE FOAM BASE. Solid thin profile ferrite suppressors. Excellent for flex-circuits and tight spaces. Various sizes can accommodate circuits up to 1.25" (31,8mm).

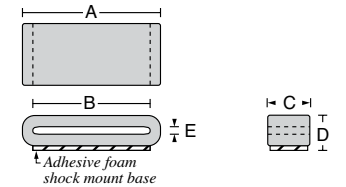

PART No.	w/Adhesive	A		B		C		D		E		IMPEDANCE IN OHMS
FX28R0984-0	FX28R0984-0A	.984	25,0	.709	18,0	.945	24,0	.303	7,7	.035	0,9	220 @ 100MHz
FX28R0984-2	FX28R0984-2A	.984	25,0	.709	18,0	.630	16,0	.303	7,7	.035	0,9	170 @ 100MHz
FX28R1261-2	FX28R1261-2A	1.260	32,0	.988	25,1	.382	9,7	.303	7,7	.035	0,9	135 @ 100MHz
FX28R1450-1	FX28R1450-1A	1.450	36,8	1.165	29,6	.394	10,0	.303	7,7	.035	0,9	130 @ 100MHz
FX28R1457-4	FX28R1457-4A	1.457	37,0	1.299	33,0	.530	13,5	.177	4,5	.020	0,5	140 @ 100MHz

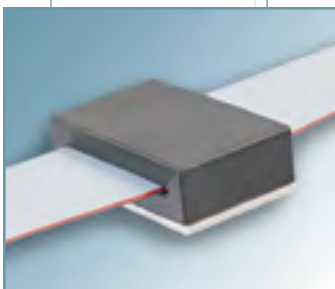

rectangular solids

WITH OPTIONAL SHOCK-MOUNT ADHESIVE FOAM BASE. Solid ferrite suppressors configured to accept flat ribbon cables. Must be installed prior to termination of the cable. High tack adhesive mounting pad secures the cable routing to a fixed point on almost any surface. Can be stacked one on top of another. A variety of designs accommodate special installation and insertion loss requirements.

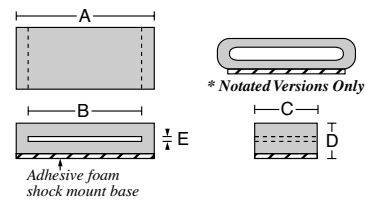

PART No.	w/Adhesive	A		B		C		D		E		IMPEDANCE IN OHMS
28B0785	SM28B0785	.785	19,9	.515	13,1	1.100	27,9	.445	11,3	.145	3,7	170 @ 100MHz
28R1531*	SM28R1531*	1.530	38,9	1.045	26,5	1.125	28,6	1.055	26,8	.510	13,0	196 @ 100MHz
28B1775	SM28B1775	1.775	45,1	1.355	34,4	1.125	28,6	.520	13,2	.060	1,52	293 @ 100MHz
28B1779	SM28B1779	2.500	63,5	2.050	52,1	1.125	28,6	.530	13,5	.066	1,68	295 @ 100MHz
28B1101	SM28B1101	1.101	28,0	.902	22,9	.577	14,7	.335	8,5	.059	1,5	133 @ 100MHz
28B1775-1	SM28B1775-1	1.775	45,1	1.355	34,4	.500	12,7	.520	13,2	.060	1,5	151 @ 100MHz
28B2170-1	SM28B2170-1	2.170	55,1	1.720	43,7	.500	12,7	.530	13,5	.050	1,3	176 @ 100MHz
28B2002	SM28B2002	2.394	60,8	2.000	50,8	.610	15,5	.724	18,4	.300	7,6	109 @ 100MHz
28B3149	SM28B3149	3.149	80,0	2.700	68,6	.500	12,7	.502	12,8	.075	1,9	93 @ 100MHz

saddle beads®



HALF-TOROIDS AND HALF-BEADS WITH OR WITHOUT ADHESIVE MOUNT BASE.

Absorbs RFI right at the source before resonance and harmonics effects are transferred to neighboring components.

U-shaped with central opening extending directly to the outside radius for easy mounting. By simply straddling a cable or PCB component, a significant amount of magnetic coupling occurs, between 30%-40% of the impedance of our fully circumferential styles, depending on configuration.

Excellent for quick, economical applications, tight spaces, electronic enclosure cable routing, and especially direct mounting over leaded or surface mount printed circuit components. Attaches to any surface with optional adhesive foam base or common electronic adhesives.

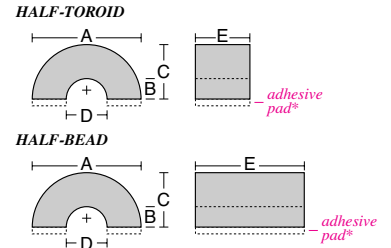

* Optional adhesive mount base .030" (0,7mm) thick
+ Point of measured impedance (see impedance below)

PART No. without Adhesive Mount	PART No. with Adhesive Mount	A	B	C	D	E	TYPE	IMPEDANCE IN OHMS (ref.)					
SB28B0550	SB28B0550AB	.550	14,0	.107	2,7	.275	7,0	.214	5,4	1.105	28,0	half bead	100 @ 100MHz
SB28B0617	SB28B0617AB	.617	15,7	.138	3,5	.308	7,8	.276	7,0	1.125	28,6	half toroid	95 @ 100MHz
SB28B0642	SB28B0642AB	.642	16,3	.150	3,8	.341	8,7	.320	8,1	.630	16,0	half toroid	30 @ 100MHz
SB28B0805	SB28B0805AB	.805	20,4	.172	4,3	.402	10,2	.404	10,3	.394	10,0	half toroid	25 @ 100MHz
SB28B0937	SB28B0937AB	.937	23,8	.224	5,7	.468	11,9	.449	11,4	.551	14,0	half toroid	34 @ 100MHz
SB28B1123	SB28B1123AB	1.123	28,5	.271	6,9	.561	14,2	.543	13,8	1.125	28,6	half toroid	83 @ 100MHz
SB28B0984	SB28B0984AB	.984	25,0	.295	7,5	.492	12,5	.591	15,0	.472	12,0	half toroid	37 @ 100MHz
SB28B1251	SB28B1251AB	1.251	31,8	.375	9,5	.625	15,9	.750	19,1	.875	22,2	half toroid	50 @ 100MHz
SB28B1501	SB28B1501AB	1.500	38,1	.375	9,5	.750	19,1	.750	19,1	1.000	25,4	half toroid	80 @ 100MHz
SB28B1500	SB28B1500AB	1.500	38,1	.500	12,7	.750	19,1	1.000	25,4	1.000	25,4	half toroid	75 @ 100MHz
SB28B2000	SB28B2000AB	2.000	50,0	.500	12,7	1.000	25,4	1.000	25,4	1.500	38,1	half toroid	175 @ 100MHz



saddle beads®

HALF-SLEEVES AND RECTANGULAR PLATES WITH OR WITHOUT ADHESIVE MOUNT BASE.

Absorbs RFI right at the source before resonance and harmonics effects are transferred to neighboring components.

Rectangular sleeves or plate shapes with central opening extending outward to easily straddle a cable or PCB component, introducing a significant amount of magnetic coupling and impedance. Between 30% to 40% of the impedance of our fully enclosed styles, depending on configuration.

When affixed with thermally conductive adhesive to flat components, such as semiconductors, heat sink thermal dissipation occurs, increasing component efficiency. Attaches to any surface with optional adhesive foam base or common electronic adhesives.

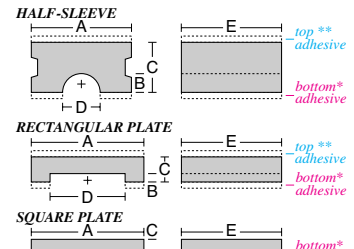

* Optional adhesive bottom mount base .030" (0,7mm)
** Optional adhesive top mount base .030" (0,7mm)
+ Point of measured impedance (see impedance below)

PART No. without Adhesive Mount	PART No. with top** Adhesive Mount	PART No. with bottom* Adhesive Mount	A	B	C	D	E	TYPE	IMPEDANCE IN OHMS (ref.)					
SB28B2027	SB28B2027AT	SB28B2027AB	.296	7,5	.048	1,2	.148	3,8	.096	2,4	.297	7,5	half sleeve	18 @ 100MHz
SB28B2034	SB28B2034AT	SB28B2034AB	.445	11,3	.110	2,8	.200	5,1	.220	5,6	1.000	25,4	half sleeve	30 @ 100MHz
SB28B2031	SB28B2031AT	SB28B2031AB	.536	13,6	.125	3,2	.270	6,9	.250	6,4	1.100	27,9	half sleeve	45 @ 100MHz
SB28B2030	SB28B2030AT	SB28B2030AB	.638	16,2	.176	4,5	.319	8,1	.352	9,0	1.100	27,9	half sleeve	40 @ 100MHz
SB28B2041	SB28B2041AT	SB28B2041AB	.800	20,3	.200	5,1	.400	10,2	.400	10,2	1.100	27,9	half sleeve	40 @ 100MHz
SB28B2032	SB28B2032AT	SB28B2032AB	.965	24,5	.256	6,5	.492	12,5	.512	13,0	1.050	26,7	half sleeve	60 @ 100MHz
SB28B2035	SB28B2035AT	SB28B2035AB	.965	24,5	.365	9,3	.492	12,5	.730	18,5	1.050	26,7	half sleeve	65 @ 100MHz
SB28B2039	SB28B2039AT	SB28B2039AB	1.400	35,5	.255	6,5	.700	17,8	.510	13,0	1.500	38,1	half sleeve	245 @ 100MHz
SB28B2043	SB28B2043AT	SB28B2043AB	1.400	35,5	.375	9,5	.700	17,8	.750	17,8	1.500	38,1	half sleeve	125 @ 100MHz
SB28B0010	SB28B0010AT	SB28B0010AB	.325	8,3	.062	1,6	.163	4,1	.125	3,2	.600	15,2	half sleeve	20 @ 100MHz
SB28B0071	SB28B0071AT	SB28B0071AB	.710	18,0	.030	0,7	.130	3,3	.510	13,0	.500	12,7	rectangular plate	23 @ 100MHz
SB28B0121	SB28B0121AT	SB28B0121AB	1.210	30,7	.030	0,7	.130	3,3	1.010	25,7	.500	12,7	rectangular plate	35 @ 100MHz
SB28B0146	SB28B0146AT	SB28B0146AB	1.460	37,1	.030	0,7	.130	3,3	1.260	32,0	.500	12,7	rectangular plate	30 @ 100MHz
SB28B0221	SB28B0221AT	SB28B0221AB	2.210	56,1	.030	0,7	.130	3,3	2.010	51,1	.500	12,7	rectangular plate	30 @ 100MHz
SB28B1729	SB28B1729AT	SB28B1729AB	1.729	43,9	.030	0,7	.250	6,4	1.355	34,4	1.125	28,6	rectangular plate	80 @ 100MHz
SB28B2375	SB28B2375AT	SB28B2375AB	2.350	59,7	.030	0,7	.250	6,4	1.720	43,7	1.000	25,4	rectangular plate	79 @ 100MHz
SB28B2480	SB28B2480AT	SB28B2480AB	2.500	63,5	.030	0,7	.250	6,4	2.047	52,0	1.125	28,6	rectangular plate	100 @ 100MHz
SB28B3012	SB28B3012AT	SB28B3012AB	3.000	76,2	.030	0,7	.250	6,4	2.540	64,5	1.125	28,6	rectangular plate	105 @ 100MHz
SB28B3500	SB28B3500AT	SB28B3500AB	3.500	86,5	.030	0,7	.250	6,4	3.000	76,2	1.125	28,6	rectangular plate	125 @ 100MHz
SB28B4340	SB28B4340AT	SB28B4340AB	4.340	110,2	.052	1,3	.250	6,4	3.240	82,3	1.125	28,6	rectangular plate	150 @ 100MHz
SB28B0500	N/A	SB28B0500AB	.500	12,7	N/A	N/A	.250	6,4*	N/A	.500	12,7	square plate	25 @ 100MHz	
SB28B0500-1	N/A	SB28B0500-1AB	.500	12,7	N/A	N/A	.100	2,5	N/A	.500	12,7	square plate	10 @ 100MHz	
SB28B0875	N/A	SB28B0875AB	.875	22,2	N/A	N/A	.250	6,4*	N/A	.875	22,2	square plate	40 @ 100MHz	
SB28B0875-1	N/A	SB28B0875-1AB	.875	22,2	N/A	N/A	.100	2,5	N/A	.875	22,2	square plate	24 @ 100MHz	
SB28B1055	N/A	SB28B1055AB	1.055	26,8	N/A	N/A	.250	6,4*	N/A	1.055	26,8	square plate	65 @ 100MHz	
SB28B1055-1	N/A	SB28B1055-1AB	1.055	26,8	N/A	N/A	.100	2,5	N/A	1.055	26,8	square plate	28 @ 100MHz	
SB28B2100	N/A	SB28B2100AB	2.100	53,3	N/A	N/A	.250	6,4*	N/A	2.100	53,3	square plate	130 @ 100MHz	
SB28B2100-1	N/A	SB28B2100-1AB	2.100	53,3	N/A	N/A	.100	2,5	N/A	2.100	53,3	square plate	70 @ 100MHz	

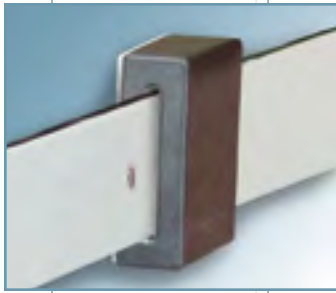

rectangular solid bus bar ferrite

EXTRA WIDE OPENING WITH OPTIONAL ADHESIVE MOUNTING. Excellent for bus bar thicknesses up to .500" (12,7mm). Three sizes accommodate bus bar widths up to 2.000" (50,8mm). Optional high tack adhesive mounting secures to almost any surface. Can be stacked one upon the other.

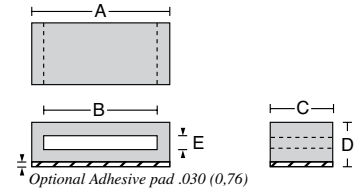

PART No.	w/ adhesive	A	B	C	D	E	IMPEDANCE IN OHMS	
28B0785	SM28B0785	.785 19,9	.515 13,1	1.100 27,9	.415 10,5	.145 3,7	170 @ 100MHz	
28R1531	SM28R1531	1.530 38,9	1.045 26,5	1.125 28,6	1.025 26,0	.510 13,0	196 @ 100MHz	
28B2002	SM28B2002	2.394 60,8	2.000 50,8	.610 15,5	.694 17,6	.300 7,6	109 @ 100MHz	



rectangular split ferrite bus bar clamp

EXTRA WIDE OPENING WITH ADHESIVE FOAM MOUNTING BASE. All-purpose series of two sizes accommodate all bus bar widths up to 2.45" (62,2mm) and thicknesses up to .285" (6,5mm). Installs easily by peeling protective paper liner from base.

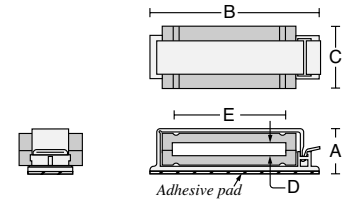

PART No.	A	B	C	D	E	IMPEDANCE IN OHMS	
FA28B2940	1.040 26,4	3.700 94,0	1.125 28,6	.290 7,3	2.500 63,5	160 @ 100MHz	



rectangular split ferrite bus bar clamp

EXTRA WIDE OPENING WITH PRESS-FIT MOUNTING BASE. For bus bar widths up to 2.45" (62,2mm) and thicknesses up to .285" (6,5mm). Installs easily by pressing the integral spring tab fastener into a .250" (6,4mm) diameter hole. Accommodates panel thicknesses up to .150" (3,81mm).



PART No.	A	B	C	D	E	F	G	IMPEDANCE IN OHMS	
FF28B2440	1.040 26,4	3.180 80,8	1.125 28,6	.290 7,3	2.000 50,8	.390 9,9	.200 5,1	180 @ 100MHz	
FF28B2940	1.040 26,4	3.700 94,0	1.125 28,6	.290 7,3	2.500 63,5	.390 9,9	.200 5,1	160 @ 100MHz	

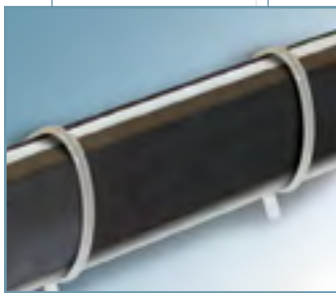

special purpose shielding bar

For situations where extremely high amounts of attenuation are needed. Can be strapped longitudinally onto bus bars with common cable tie-wraps; or, potting compounds can be used. Sandwiching the bus bar between two shielding bars will dramatically increase impedance up to three times the effect of a single bar depending on frequencies involved. Optional adhesive pad facilitates mounting.

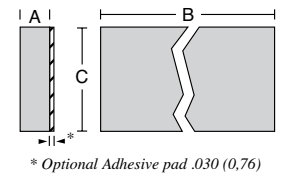

PART No.	w/ adhesive	A	B	C	IMPEDANCE IN OHMS	
SB28B5630	SB28B5630A	.365 9,3	5.630 143,0	1.00 25,4	one pass: 500 @ 100MHz	



universal-fit clamps and sleeves

STANDARD CATALOG CABLE FERRITE ASSEMBLIES. Any of the round or flat cable clamps shown elsewhere in this catalog make a perfectly good solution for many bus bar geometries and their mounting requirements. A properly placed suppressor will attenuate unwanted high frequency signals, thus negating the conductor and/or antenna-like radiating effects at specific frequencies while not disturbing the power distribution characteristics.

cable snap



Ferrite assembly in fully enclosed nylon case; functional with wires and cables up to a 2.0" (50,8mm) diameter. Snap closed around wire by clasping shut to position assembly.

May also be mounted with a flat-head screw through the .120" (3,0mm) diameter hole in the bottom by temporarily removing lower ferrite half.

Very effective from 1 MHz to 60 MHz; peak attenuation at 30 MHz. See pages 32 and 33 for impedance curve characteristics.

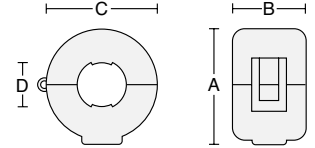

PART No.	A	B	C	D	IMPEDANCE IN OHMS
CS33B1805	1.040 26,4	.667 16,9	1.025 26,4	.340 8,6	22 @ 30MHz
CS33B1984	1.218 30,9	.705 17,9	1.220 31,0	.525 13,3	20 @ 30MHz
CS33B2000	2.350 59,7	1.851 47,0	2.309 58,6	.960 24,4	see page 31 for more details 210 @ 30MHz
CS33B4000	4.500 114,2	1.851 47,0	4.687 110,0	1.960 49,8	see page 31 for more details 140 @ 30MHz

sleeve snap



Box-shaped ferrite assembly in enclosed nylon case. Various sizes are functional with wires up to .500" (12,7mm) diameter. Simply clamp around cable or wire; plastic tabs at entry/exit ports apply pressure to cable surface to maintain mounting position. Options include foam adhesive pad on bottom.

Very effective from 1 MHz to 60 MHz; peak attenuation at 30 MHz. See pages 32 and 33 for impedance curve characteristics.

Available in standard colors gray (i.e., SS33B2030) and black (i.e., SS33B2030K)

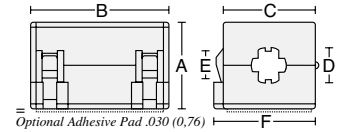

PART No.	w/ Adhesive	A	B	C	D	E	F	IMPEDANCE IN OHMS
SS33B2030 AS33B2030		.790 20,1	1.265 32,1	.770 19,6	.270 6,9	.220 5,6	.885 22,5	23 @ 30MHz
SS33B2033 AS33B2033		.790 20,1	1.265 32,1	.770 19,6	.350 8,8	.290 7,4	.885 22,5	23 @ 30MHz
SS33B2036 AS33B2036		1.155 29,3	1.250 31,8	1.125 28,6	.415 10,5	.350 8,9	1.230 31,2	27 @ 30MHz
SS33B2040 AS33B2040		1.155 29,3	1.250 31,8	1.125 28,6	.550 14,0	.480 12,2	1.230 31,2	27 @ 30MHz

Patent No. 5,764,125

sleeve snap

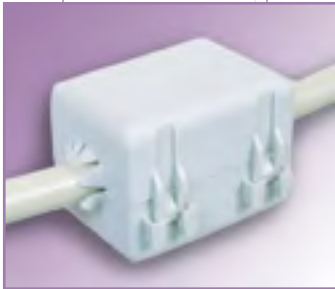

WITH VARIABLE DIAMETER END PORTS. Box-shaped ferrite assembly in fully enclosed nylon case. End ports are surrounded with flexible spring flutes to grip a range of cable diameters from .125" to .500" (3,2 to 12,7 mm). Special mounting options include foam adhesive pad on bottom.

Very effective from 1 MHz to 60 MHz; peak attenuation at 30 MHz. See pages 32 and 33 for impedance curve characteristics.

Available in standard colors gray (i.e., SS33B2037) and black (i.e., SS33B2037K)

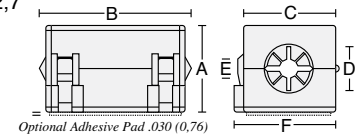

PART No.	w/ Adhesive	A	B (ref.)	C	D	E	F	IMPEDANCE IN OHMS
SS33B2037 AS33B2037		.790 20,1	1.450 36,8	.770 19,6	.350 8,8	.200 5,1	.885 22,5	23 @ 30 MHz
SS33B2032 AS33B2032		1.155 29,3	1.450 36,8	1.125 28,6	.500 12,7	.200 5,1	1.230 31,2	27 @ 30 MHz

Patent No. 5,003,278 and Patent No. 5,764,125

sleeve snap for cable bundles



Box-shaped ferrite assembly for cable bundle diameters up to .730" (18,5mm) diameter. Allows single location for RFI suppression for multiple cables. Each circuit reacts separately with the suppression material without saturation. Alternatively, multiple turns of a single cable greatly increases impedance depending on frequency - see page 6, figures 3 and 4. Optional adhesive mount base.

Very effective from 1 MHz to 60 MHz; peak attenuation at 30 MHz. See pages 32 and 33 for impedance curve characteristics.

Available in standard colors gray (i.e., SS33B2035) and black (i.e., SS33B2035K)

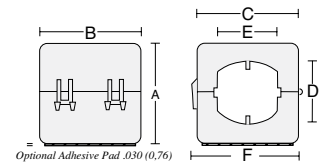

PART No.	w/ Adhesive	A	B	C	D	E	F	IMPEDANCE IN OHMS
SS33B2035 AS33B2035		1.155 29,3	1.250 31,8	1.125 28,6	.790 20,1	.720 18,3	1.230 31,2	23 @ 30MHz

cable clamp



Ferrite assembly bonded to nylon strap; functional with wires and cables up to a 1.00" (25,4 mm) diameter. Holes are provided for screw mounting.

Very effective from 1 MHz to 60 MHz; peak attenuation at 30 MHz. See pages 32 and 33 for impedance curve characteristics.

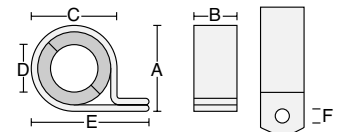

PART No.	A	B	C	D	E	F	IMPEDANCE IN OHMS
TC33B0805	.948 24,1	.500 12,7	.948 24,1	.404 10,3	1.498 38,0	.195 5,0	22 @ 30MHz
TC33B0984	1.127 28,6	.500 12,7	1.127 28,6	.591 15,0	1.677 42,6	.195 5,0	20 @ 30MHz
TC33B2000	2.125 54,0	1.500 38,1	2.125 54,0	1.000 25,4	2.860 72,6	.281 7,1	210 @ 30MHz

flat cable clamp

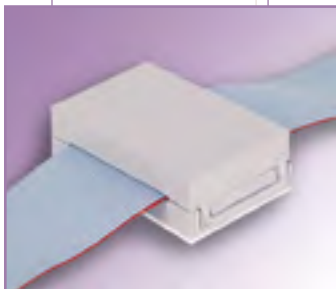

WITH FULL OUTER ENCLOSURE AND ADHESIVE MOUNT. Ferrite assembly in fully enclosed nylon case for flat cables up to 64-conductor width. Internal grip-lock tabs apply pressure on cable to maintain mounting position. Very effective from 1 MHz to 60 MHz with a peak attenuation at 30 MHz. For typical impedance curve comparisons to other material formulations, see page 33; and for specific impedance curves see page 32, bottom.

Installs easily on any mounting surface by removing liner from foam adhesive base pad. Also available without the adhesive mounting pad for assembly with two flat head screws through the .120" (3,0 mm) diameter holes on 1.25" (31,8 mm) centers in the bottom by temporarily removing the lower ferrite half.

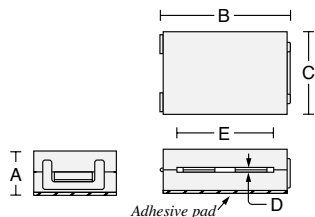

PART No.	w/o Adhesive	A	B	C	D	E	IMPEDANCE IN OHMS			
RA33B2480	RC33B2480	.700	17,8	2,76	70,1	1.312	33,3	.060 1,5	2.047 52,0	31 @ 30 MHz
RA33B4340	RC33B4340	.785	19,9	4,61	117,1	1.312	33,3	.104 2,6	3.240 82,3	79 @ 30 MHz

flat cable clamp

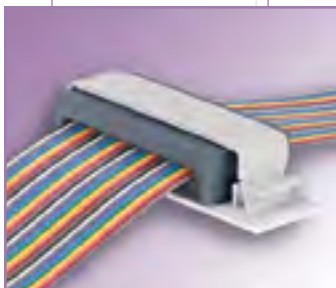

WITH ADHESIVE MOUNT. Ferrite assembly bonded in nylon mounting clamp; easily installed by peeling protective paper strip from base and pressing into place. One size accommodates all flat cables up to 40-conductor width.

Very effective from 1 MHz to 60 MHz with a peak attenuation at 30 MHz.

For typical impedance curve comparisons to other material formulations, see page 33; and for specific impedance curves see page 32, bottom

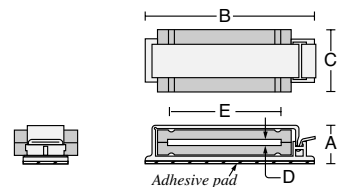

PART No.	w/o Adhesive	A	B	C	D	E	IMPEDANCE IN OHMS			
FA33B2480	FC33B2480	.800	20,3	3.180	80,8	1.125	28,6	.060 1,5	2.047 52,0	31 @ 30 MHz

flat cable clamp



WITH SINGLE PRESS FIT MOUNT. Ferrite assembly bonded in nylon mounting clamp; easily installed by pressing the integral spring tab fastener into a .250" (6,4mm) diameter hole. One size accommodates all flat cables up to 40-conductor width. Fits substrates up to .070" (1,8mm) thickness.

Very effective from 1 MHz to 60 MHz with a peak attenuation at 30 MHz.

For typical impedance curve comparisons to other material formulations, see page 33; and for specific impedance curves see page 32, bottom

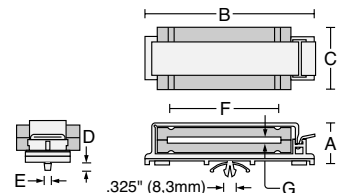

PART No.	A	B	C	D	E	F	G	IMPEDANCE IN OHMS				
FF33B2480	.800	20,3	3.180	80,8	1.125	28,6	.280	7,1	.183 4,6	2.047 52,0	.060 1,5	31 @ 30MHz

flat cable clamp



WITH DUAL PRESS FIT MOUNTS. Ferrite assembly bonded in nylon mounting clamp; easily installed by pressing the integral spring tab fasteners into two .219" (5,6mm) diameter holes. One size accommodates all flat cables up to 40-conductor width. Fits substrates up to .070" (1,8mm) thickness.

Very effective from 1 MHz to 60 MHz with a peak attenuation at 30 MHz.

For typical impedance curve comparisons to other material formulations, page 33; and for specific impedance curves see page 32, bottom

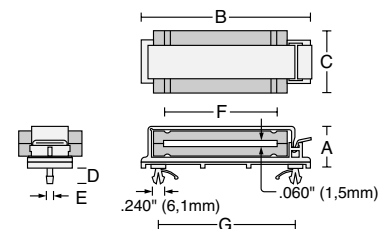

PART No.	A	B	C	D	E	F	G	IMPEDANCE IN OHMS				
FD33B2480	.800	20,3	3.180	80,8	1.125	28,6	.280	7,1	.183 4,6	2.047 52,0	2.550 64,8	31 @ 30MHz

flat cable clamp



WITH SPLIT END CAPS, ADHESIVE MOUNT. Ferrite assembly press-fitted into a pair of nylon end caps with adhesive foam mounting pads. Two sizes accommodate flat cables up to 64-conductor width.

Very effective from 1 MHz to 60 MHz with a peak attenuation at 30 MHz.

For typical impedance curve comparisons to other material formulations, see page 33; and for specific impedance curves see page 32, bottom

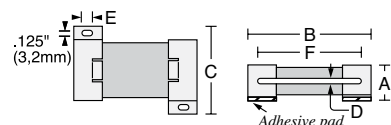

PART No.	w/o Adhesive	A	B	C	D	E	F	IMPEDANCE IN OHMS			
SA33B2480	SE33B2480	.655	16,6	2.570	65,3	1.829	46,5	.060 1,5	.245 5,7	2.047 52,0	31 @ 30 MHz
SA33B4340	SE33B4340	.655	16,6	4.460	113,3	1.829	46,5	.104 2,6	.245 5,7	3.240 82,3	79 @ 30 MHz

cable snap



Ferrite assembly in fully enclosed nylon case; functional with wires and cables up to a .20" (5,08mm) diameter. Snap closed around wire by clasping shut to position assembly.

May also be mounted with a flat-head screw through the .120" (3,0mm) diameter hole in the bottom by temporarily removing lower ferrite half.

Very effective from 100 MHz to 1 GHz; peak attenuation at 700 MHz. See pages 32 and 33 for impedance curve characteristics.

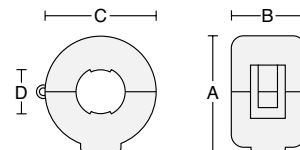

PART No.	A		B		C		D		IMPEDANCE IN OHMS	
CS25B1642	.852	21,6	.885	22,5	.840	21,3	.282	7,2	290 @ 700MHz	
CS25B1937	1.182	30,0	.780	19,8	1.188	30,2	.425	10,8	305 @ 700MHz	
CS25B1500	1.725	43,8	1.232	31,3	1.720	43,7	.960	24,4	510 @ 700MHz	
CS25B2000	2.350	59,7	1.851	47,0	2.309	58,6	.960	24,4	see page 31 for more details	890 @ 700MHz
CS25B4000	4.500	114,2	1.851	47,0	4.687	110,0	1.960	49,8	see page 31 for more details	590 @ 700MHz

sleeve snap



Box-shaped ferrite assembly in enclosed nylon case. Various sizes are functional with wires up to .500" (12,7 mm) diameter. Simply clamp around cable or wire; plastic tabs at entry/exit ports apply pressure to cable surface to maintain mounting position. Options include foam adhesive pad on bottom.

Very effective from 100 MHz to 1 GHz; peak attenuation at 700 MHz. See pages 32 and 33 for impedance curve characteristics.

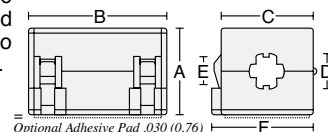

Available in standard colors gray (i.e., SS25B2030) and black (i.e., SS25B2030K)

Patent No. 5,764,125

PART No.	w/ Adhesive	A		B		C		D		E		F		IMPEDANCE IN OHMS
SS25B2030	AS25B2030	.790	20,1	1.265	32,1	.770	19,6	.270	6,9	.220	5,6	.885	22,5	390 @ 700MHz
SS25B2033	AS25B2033	.790	20,1	1.265	32,1	.770	19,6	.350	8,8	.290	7,4	.885	22,5	390 @ 700MHz
SS25B2036	AS25B2036	1.155	29,3	1.250	31,8	1.125	28,6	.415	10,5	.350	8,9	1.230	31,2	510 @ 700MHz
SS25B2040	AS25B2040	1.155	29,3	1.250	31,8	1.125	28,6	.550	14,0	.480	12,2	1.230	31,2	510 @ 700MHz

sleeve snap



WITH VARIABLE DIAMETER END PORTS. Box-shaped ferrite assembly in fully enclosed nylon case. End ports are surrounded with flexible spring flutes to grip a range of cable diameters from .125" to .500" (3,2 to 12,7 mm). Special mounting options include foam adhesive pad on bottom.

Very effective from 100 MHz to 1 GHz; peak attenuation at 700 MHz. See pages 32 and 33 for impedance curve characteristics.

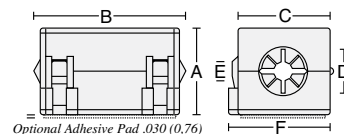

Available in standard colors gray (i.e., SS25B2037) and black (i.e., SS25B2037K)

Patent No. 5,003,278 and Patent No. 5,764,125

PART No.	w/ Adhesive	A	B (ref.)	C		D		E		F		IMPEDANCE IN OHMS
SS25B2037	AS25B2037	.790	20,1	1.450	36,8	.770	19,6	.350	8,8	.200	5,1	.885 22,5 390 @ 700 MHz
SS25B2032	AS25B2032	1.155	29,3	1.450	36,8	1.125	28,6	.500	12,7	.200	5,1	1.230 31,2 510 @ 700 MHz

internal locking snap



WITH SECURE INTERNAL LOCKING SYSTEM. Cannot be reopened after snapping closed into position. Ensures that suppressor cannot be removed. Grip-lock tabs at entry/exit ports prevent longitudinal slippage on a range of cable diameters from .275" to .300" (7,0 to 7,6mm). Standard colors are computer gray (PMS#413), computer beige (PMS#468), black and natural white. A cost-effective alternative to over-molding.

Very effective from 100 MHz to 1 GHz; peak attenuation at 700 MHz. See pages 32 and 33 for impedance curve characteristics.

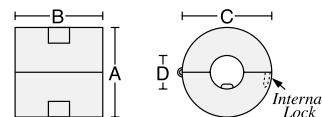

Patent Nos. 5,003,278 , 5,162,772 and 5,764,125

PART No.	A	B (ref.)	C		D		COLOR	IMPEDANCE IN OHMS		
IL25B0642W	.780	19,8	.780	19,8	.780	19,8	.316	8,0	NATURAL WHITE	290 @ 700MHz
IL25B0642G	.780	19,8	.780	19,8	.780	19,8	.316	8,0	COMPUTER GRAY	290 @ 700MHz
IL25B0642B	.780	19,8	.780	19,8	.780	19,8	.316	8,0	COMPUTER BEIGE	290 @ 700MHz
IL25B0642K	.780	19,8	.780	19,8	.780	19,8	.316	8,0	BLACK	290 @ 700MHz

cable clamp



Ferrite assembly bonded to nylon strap; functional with wires and cables up to a 1.00" (25,4 mm) diameter. Holes are provided for screw mounting.

Very effective from 100 MHz to 1 GHz; peak attenuation at 700 MHz. See pages 32 and 33 for impedance curve characteristics.



PART No.	A	B	C		D		E	F	IMPEDANCE IN OHMS
TC25B0642	.785	19,9	.630	16,0	.785	19,9	.320	8,1	1.335 33,9 .195 5,0 290 @ 700MHz
TC25B0937	1.127	28,6	.551	14,0	1.127	28,6	.449	11,4	1.677 42,6 .195 5,0 305 @ 700MHz
TC25B1500	1.628	41,4	1.000	25,4	1.628	41,4	1.000	25,4	2.150 55,5 .195 5,0 510 @ 700MHz
TC25B2000	2.125	54,0	1.500	38,1	2.125	54,0	1.000	25,4	2.860 72,6 .281 7,1 890 @ 700MHz

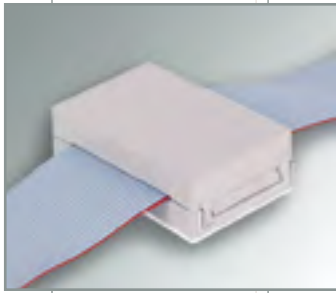

flat cable clamp

WITH FULL OUTER ENCLOSURE AND ADHESIVE MOUNT. Ferrite assembly in fully enclosed nylon case for flat cables up to 40-conductor width. Internal grip-lock tabs apply pressure on cable to maintain mounting position. Very effective from 100 MHz to 1 GHz; peak attenuation at 700 MHz. See pages 32 and 33 for impedance curve characteristics.

Installs easily on any mounting surface by removing liner from foam adhesive base pad. Also available without the adhesive mounting pad for assembly with two flat head screws through the .120" (3,0 mm) diameter holes on 1.25" (31,8 mm) centers in the bottom by temporarily removing the lower ferrite half. Excellent for flex-circuits.

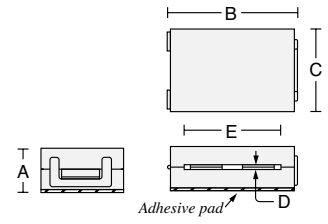

PART No.	w/o Adhesive	A	B	C	D	E	IMPEDANCE IN OHMS		
RA25B2480	RC25B2480	.700	17,8	2.76	70,1	1.312	33,3	.060 1,5 2.047 52,0	790 @ 700 MHz
RA25B4340	RC25B4340	.785	19,9	4.61	117,1	1.312	33,3	.104 2,6 3.240 82,3	930 @ 700 MHz

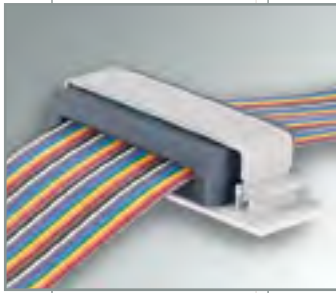

flat cable clamp

WITH ADHESIVE MOUNT. Ferrite assembly bonded in nylon mounting clamp; easily installed by peeling protective paper strip from base and pressing into place. Two sizes accommodate all flat cables up to 40-conductor width.

Very effective from 100 MHz to 1 GHz; peak attenuation at 700 MHz. See pages 32 and 33 for impedance curve characteristics.

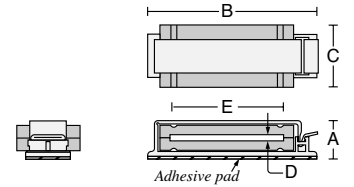

PART No.	w/o Adhesive	A	B	C	D	E	IMPEDANCE IN OHMS		
FA25B0121	FC25B0121	.520	13,2	1.790	45,5	.750	19,1	.060 1,5 1.010 25,7	245 @ 700 MHz
FA25B2480	FC25B2480	.800	20,3	3.180	80,8	1.125	28,6	.060 1,5 2.047 52,0	790 @ 700 MHz



flat cable clamp

WITH SINGLE PRESS FIT MOUNT. Ferrite assembly bonded in nylon mounting clamp; easily installed by pressing the integral spring tab fastener into a .250" (6,4mm) diameter hole. Two sizes accommodate all flat cables up to 40-conductor width. Fits substrates up to .070" (1,8mm) thickness.

Very effective from 100 MHz to 1 GHz; peak attenuation at 700 MHz. See pages 32 and 33 for impedance curve characteristics.

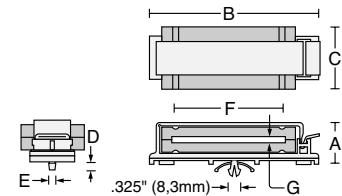

PART No.	A	B	C	D	E	F	G	IMPEDANCE IN OHMS		
FF25B0121	.475	12,7	1.790	45,5	.750	19,1	.325	8,3	.240 6,1 1.010 25,7 .060 1,5	245 @ 700MHz
FF25B2480	.800	20,3	3.180	80,8	1.125	28,6	.280	7,1	.183 4,6 2.047 52,0 .060 1,5	790 @ 700MHz



flat cable clamp

WITH DUAL PRESS FIT MOUNTS. Ferrite assembly bonded in nylon mounting clamp; easily installed by pressing the integral spring tab fasteners into two .219" (5,6mm) diameter holes. One size accommodates all flat cables up to 40-conductor width. Fits substrates up to .070" (1,8mm) thickness.

Very effective from 100 MHz to 1 GHz; peak attenuation at 700 MHz. See pages 32 and 33 for impedance curve characteristics.

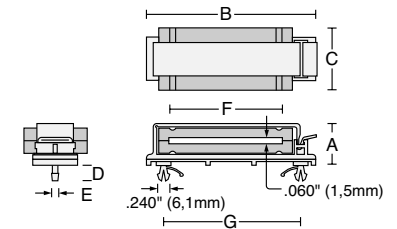

PART No.	A	B	C	D	E	F	G	IMPEDANCE IN OHMS		
FD25B2480	.800	20,3	3.180	80,8	1.125	28,6	.280	7,1	.183 4,6 2.047 52,0 2.550 64,8	790 @ 700MHz



flat cable clamp

WITH SPLIT END CAPS, ADHESIVE MOUNT. Ferrite assembly press-fitted into a pair of nylon end caps with adhesive foam mounting pads. Two sizes accommodate flat cables up to 40-conductor width.

Very effective from 100 MHz to 1 GHz; peak attenuation at 700 MHz. See pages 32 and 33 for impedance curve characteristics.

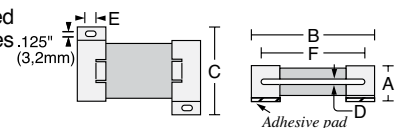

PART No.	w/o Adhesive	A	B	C	D	E	F	IMPEDANCE IN OHMS	
SA25B0121	SE25B0121	.405	10,3	1.315	33,4	1.190	30,2	.060 1,5 .245 5,7 1.010 25,7	245 @ 700 MHz
SA25B2480	SE25B2480	.655	16,6	2.570	65,3	1.829	46,5	.060 1,5 .245 5,7 2.047 52,0	790 @ 700 MHz
SA25B4340	SE25B4340	.655	16,6	4.460	113,3	1.829	46,5	.104 2,6 .245 5,7 3.240 82,3	930 @ 700 MHz



sleeve snap

Box-shaped ferrite assembly in enclosed nylon case. Various sizes are functional with wires up to .400" (10,2 mm) diameter. Simply clamp around cable or wire; plastic tabs at entry/exit ports apply pressure to cable surface to maintain mounting position. Options include foam adhesive pad on bottom.

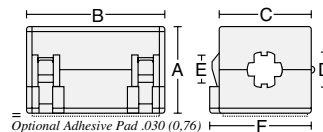

Available in standard colors gray (i.e., SS20B2030) and black (i.e., SS20B2030K)

Patent No. 5,764,125

PART No.	w/ Adhesive	A	B	C	D	E	F						
SS20B2030	AS20B2030	.790	20,1	1.265	32,1	.770	19,6	.270	6,9	.220	5,6	.885	22,5
SS20B2033	AS20B2033	.790	20,1	1.265	32,1	.770	19,6	.350	8,8	.290	7,4	.885	22,5
SS20B2041	AS20B2041	.965	24,5	1.285	32,6	.930	23,6	.450	11,4	.380	9,7	1.035	26,3

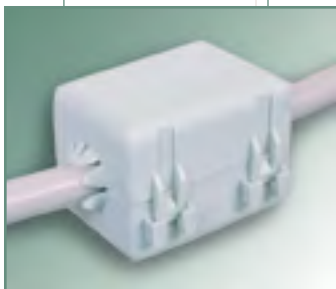

sleeve snap

WITH VARIABLE DIAMETER END PORTS. Box-shaped ferrite assembly in fully enclosed nylon case. End ports are surrounded with flexible spring flutes to grip a range of cable diameters from .125" to .400" (3,2 to 10,2 mm). Special mounting options include foam adhesive pad on bottom.

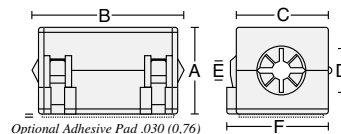

Patent No. 5,003,278 and Patent No. 5,764,125

PART No.	w/ Adhesive	A	B (ref.)	C	D	E	F						
SS20B2034	AS20B2034	.585	14,9	1.250	31,8	.585	14,9	.250	6,4	.120	3,0	.680	17,3
SS20B2037	AS20B2037	.790	20,1	1.450	36,8	.770	19,6	.350	8,8	.200	5,1	.885	22,5
SS20B2042	AS20B2042	.965	24,5	1.480	37,6	.930	23,6	.425	10,8	.170	4,3	1.035	26,3



cable snap for cable bundles

Ferrite assembly in fully enclosed nylon case; functional with wires and cables up to a 2.0" (50,8mm) diameter. Snap closed around wire by clasping shut to position assembly.

May also be mounted with a flat-head screw through the .120" (3,0mm) diameter hole in the bottom by temporarily removing lower ferrite half.

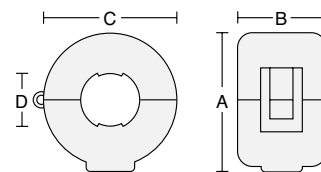

PART No.	A	B	C	D				
CS20B1500	1.725	43,8	1.232	31,3	1.720	43,7	.960	24,4
CS20B2000	2.350	59,7	1.851	47,0	2.309	58,6	.960	24,4
CS20B4000	4.500	114,2	1.851	47,0	4.687	119,0	1.960	49,8



cable clamp for cable bundles

Ferrite assembly bonded to nylon strap; functional with wires and cables up to a 1.00" (25,4 mm) diameter. Holes are provided for screw mounting.

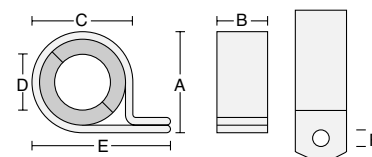

PART No.	A	B	C	D	E	F						
TC20B1500	1.628	41,4	1.000	25,4	1.628	41,4	1.000	25,4	2.150	55,5	.195	5,0
TC20B2000	2.125	54,0	1.500	38,1	2.125	54,0	1.000	25,4	2.860	72,6	.281	7,1



solid beads

Sizes up to .430" I.D. (10,9 mm) for applications where it is possible to assemble the ferrite suppressor before the cable ends are terminated.

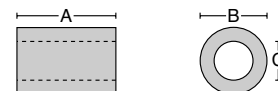

PART No.	A	B	C			
20B0562-2	1.125	28,6	.562	14,2	.250	6,4
20B0736-0	1.125	28,6	.736	18,7	.430	10,9

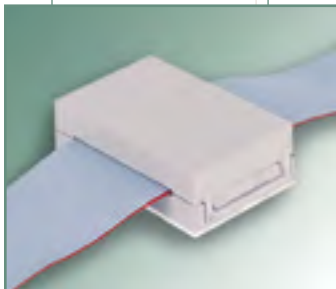

flat cable clamp

WITH FULL OUTER ENCLOSURE AND ADHESIVE MOUNT. Ferrite assembly in fully enclosed nylon case. Two sizes functional with flat cables up to 40-conductor widths. Internal grip-lock tabs apply pressure on cable to maintain mounting position.

Installs easily on any mounting surface by removing liner from foam adhesive base pad. Excellent for flex-circuits.



PART No.	w/o Adhesive	A	B	C	D	E
RA20B1729	RC20B1729	.700	17,8	2.03	51,6	1.312 33,3 .060 1,5 1.355 34,4
RA20B2480	RC20B2480	.700	17,8	2.76	70,1	1.312 33,3 .060 1,5 2.047 52,0



flat cable clamp

WITH ADHESIVE MOUNT. Ferrite assembly bonded in nylon mounting clamp; easily installed by peeling protective paper strip from base and pressing into place. For flat cables up to 40-conductor width 2.00" (50,8 mm).

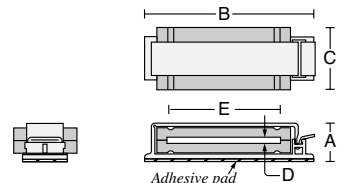

PART No.	w/o Adhesive	A	B	C	D	E
FA20B1729	FC20B1729	.800	20,3	2.430	61,7	1.125 28,6 .060 1,5 1.355 34,4
FA20B2480	FC20B2480	.800	20,3	3.180	80,8	1.125 28,6 .060 1,5 2.047 52,0

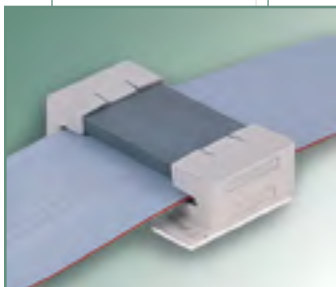

flat cable clamp

WITH SPLIT END CAPS, ADHESIVE MOUNT. Ferrite assembly press-fitted into a pair of nylon end caps with adhesive foam mounting pads. For flat cables up to 40-conductor width 2.00" (50,8 mm).

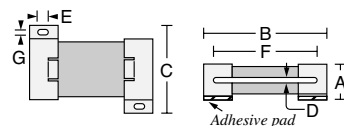

PART No.	w/o Adhesive	A	B	C	D	E	F	G
SA20B1729	SE20B1729	.655	16,6	1.849	47,0	1.829 46,5 .060 1,5 .245 5,7 1.355 34,4 .125 3,2		
SA20B2480	SE20B2480	.655	16,6	2.570	65,3	1.829 46,5 .060 1,5 .245 5,7 2.047 52,0 .125 3,2		



low profile solids

ULTRA-THIN. Excellent for thin flex circuits and flat cables. Two sizes accommodate cable widths up to 1.325" (33,7 mm).

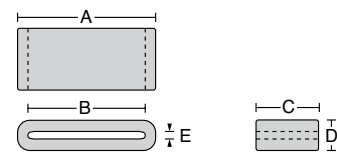

PART No.	A	B	C	D	E
20R1260	1.260 32,0	1.010 25,7	1.125 28,6	.300 7,6	.051 1,3
20R1575	1.575 40,0	1.325 33,7	1.125 28,6	.300 7,6	.051 1,3



low profile solids

ULTRA-THIN WITH SHOCK MOUNT ADHESIVE FOAM BASE. Excellent for thin flex circuits and flat cables. Two sizes accommodate cable widths up to 1.325" (33,7mm). High tack adhesive mounting pad secures to almost any surface. Can be stacked one on top of another.



PART No.	A	B	C	D	E
SM20R1260	1.260 32,0	1.010 25,7	1.125 28,6	.330 8,4	.051 1,3
SM20R1575	1.575 40,0	1.325 33,7	1.125 28,6	.330 8,4	.051 1,3

3-Steps to Reducing RFID Interference

Radio Frequency Identification (RFID) is a rapidly expanding technology with new applications emerging at a remarkable rate. From management of warehouse inventory to identification of patients in a medical setting, proper deployment and unimpeded communication between RFID readers and tags is paramount to successful operation.

One of the major considerations when implementing an RFID system is the effect of unwanted RF interference between Readers and Tags. Most workplaces have hundreds if not thousands of electronic devices that create unwanted interference, including computers, Bluetooth networks, wireless networks, motors, conveyors and robots. Actually, any device with a microchip and power cord or cable will emit RF energy which can interfere with the ability of the reader to receive a clean signal.



Leader Tech offers a simple “first-step” approach to reducing unwanted RF interference. We recommend the following:

Identify Sources of RFID Interferences

The FerriShield CTK031 hand-held probe (see below) is one of the easiest ways to identify unwanted electro-magnetic interference. All you need to do is pass the probe over suspect sources. If the device detects RF emissions it alerts with an audible tone that intensifies as interference increases.

Attach a Frequency-Specific RFID Ferrite to the Suspect Device

Samplings of our most popular RFID ferrites are shown on the following page. In addition, a free 32-piece engineering kit is provided with the purchase of any CTK031 Probe.

Check If Interference Has Been Eliminated

After you have attached the cable-mounted ferrite, simply use the hand-held RF probe to confirm that the ferrite has eliminated the unwanted interference.

CTK031 – SCAN EM-C PROBE SET WITH DEMO FIXTURE

Contains both CTM030 electric and CTM032 magnetic near-field probes along with a step-by-step guide, an EMC Demo Fixture, and cables with adapters for spectrum analyzer, oscilloscope or multimeter. Free ferrite engineering kit included. See information at lower right.



FREE #EK28B0032 FERRITE ENGINEERING KIT WITH EITHER SCANEM PROBE KIT PURCHASE

Our popular, wideband assortment of 32 unique configurations for RFID EMI cable suppression.

CTK031 W/ BOTH PROBES	PROBE	PROBE
Parameters	CTM030	CTM032
Fields	Electric	Magnetic
Frequency Response	2MHz - 2GHz	1MHz - 1GHz
RF Output	Yes	Yes
DC Output to a multimeter	Yes	Yes
Sensitivity (typical)	-10dBm/(V/m)	-20dBm/ma
Connector	SMB/BNC	SMB/BNC
Dimensions (approx.)	6.18" x 1.21" x 0.76" (157 x 31 x 20mm)	6.18" x 1.21" x 0.76" (157 x 31 x 20mm)
Weight (approx.)	2.25oz (65g)	2.25oz (65g)
Battery (included)	2 x AAA	2 x AAA
LED Bar Graph	5 LED color bar	5 LED color bar
Audio Indication	Speaker (tone pitch proportional to the field strength)	

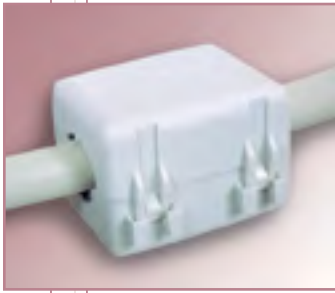

sleeve snap for round cables

Three common sizes in three frequency-specific formulations. Box-shaped assembly snaps over cables up to .400" (10,1mm) diameter. Optional foam adhesive mounting pad on bottom.

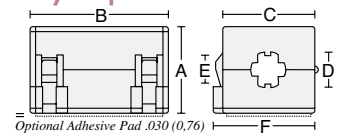

PART No.	w/adhesive	A	B	C	D	E	F	Target Frequency/Range	Impedance in Ohms
SS28B2030	AS28B2030	.790 20,1	1.265 32,1	.770 19,6	.270 6,9	.220 5,6	.885 22,5	13.56MHz	200 @ 100MHz
SS28B2033	AS28B2033	.790 20,1	1.265 32,1	.770 19,6	.350 8,8	.290 7,4	.885 22,5	13.56MHz	200 @ 100MHz
SS28B2041	AS28B2041	.965 24,5	1.285 32,6	.930 23,6	.450 11,4	.380 9,7	1.035 26,3	13.50MHz	238 @ 100MHz
SS25B2030	AS25B2030	.790 20,1	1.265 32,1	.770 19,6	.270 6,9	.220 5,6	.885 22,5	433.92MHz & 860-930MHz	340 @ 700MHz
SS25B2033	AS25B2033	.790 20,1	1.265 32,1	.770 19,6	.350 8,8	.290 7,4	.885 22,5	433.92MHz & 860-930MHz	290 @ 700MHz
SS20B2030	AS20B2030	.790 20,1	1.265 32,1	.770 19,6	.270 6,9	.220 5,6	.885 22,5	2.45GHz	per application
SS20B2033	AS20B2033	.790 20,1	1.265 32,1	.770 19,6	.350 8,8	.290 7,4	.885 22,5	2.45GHz	per application
SS20B2041	AS20B2041	.965 24,5	1.285 32,6	.930 23,6	.450 11,4	.380 9,7	1.035 26,3	2.45GHz	per application

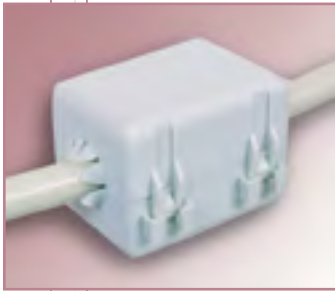

sleeve snap for round cables

WITH VARIABLE DIAMETER END PORTS. Four sizes fit cable diameters from .125" to .500" (3,2 to 12,7mm); end ports are surrounded by flexible spring flutes to grip a range of diameters. Three choices of frequency-specific material formulations. Optional foam adhesive mounting pad on bottom.

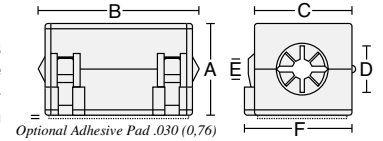

PART No.	w/adhesive	A	B(ref.)	C	D	E	F	Target Frequency/Range	Impedance in Ohms
SS28B2034	AS28B2034	.585 14,9	1.250 31,8	.585 14,9	.250 6,4	.120 3,0	.680 17,3	13.56MHz	220 @ 100MHz
SS28B2037	AS28B2037	.790 20,1	1.450 36,8	.770 19,6	.350 8,8	.200 5,1	.885 22,5	13.56MHz	200 @ 100MHz
SS28B2042	AS28B2042	.965 24,5	1.480 37,6	.930 23,6	.425 10,8	.170 4,3	1.035 26,3	13.56MHz	238 @ 100MHz
SS28B2032	AS28B2032	1.155 29,3	1.450 36,8	1.125 28,6	.500 12,7	.200 5,1	1.230 31,2	13.56MHz	238 @ 100MHz
SS25B2037	AS25B2037	.790 20,1	1.450 36,8	.770 19,6	.350 8,8	.200 5,1	.885 22,5	433.92MHz & 860-930MHz	390 @ 700MHz
SS25B2032	AS25B2032	1.155 29,3	1.450 36,8	1.125 28,6	.500 12,7	.200 5,1	1.230 31,2	433.92MHz & 860-930MHz	510 @ 700MHz
SS20B2034	AS20B2034	.585 14,9	1.250 31,8	.585 14,9	.250 6,4	.120 3,0	.680 17,3	2.45GHz	per application
SS20B2037	AS20B2037	.790 20,1	1.450 36,8	.770 19,6	.350 8,8	.200 5,1	.885 22,5	2.45GHz	per application
SS20B2042	AS20B2042	.965 24,5	1.480 37,6	.930 23,6	.425 10,8	.170 4,3	1.035 26,3	2.45GHz	per application



cable snap for round cables

Ferrite assembly in fully enclosed nylon case; functional with cables and bundles up to a 2.0" (50,8mm) diameter. Three choices of frequency-specific material formulations. Optional foam adhesive mounting pad on bottom.

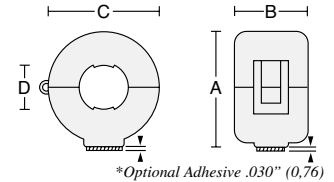

PART No.	w/adhesive	A	B	C	D	Target Frequency/Range	Impedance in Ohms
CS28B1642	CA28B1642	.852 21,6	.885 22,5	.840 21,3	.282 7,2	13.56MHz	100 @ 100MHz
CS28B1805	CA28B1805	1.040 26,4	.667 16,9	1.025 26,4	.340 8,6	13.56MHz	73 @ 100MHz
CS28B1937	CA28B1937	1.182 30,0	.780 19,6	1.188 30,2	.425 10,8	13.56MHz	117 @ 100MHz
CS28B1984	CA28B1984	1.218 30,9	.705 17,9	1.220 31,0	.525 13,3	13.56MHz	62 @ 100MHz
CS28B1501	CA28B1501	1.725 43,8	1.232 31,3	1.720 43,7	.710 18,0	13.56MHz	177 @ 100MHz
CS28B1500	CA28B1500	1.725 43,8	1.232 31,3	1.720 43,7	.960 24,4	13.56MHz	133 @ 100MHz
CS28B2000	CA28B2000	2.350 59,7	1.851 47,0	2.309 58,6	.960 24,4	13.56MHz	380 @ 100MHz
CS28B4000	CA28B4000	4.500 114,2	1.851 47,0	4.687 119,0	1.960 49,8	13.56MHz	290 @ 100MHz
CS25B1642	CA25B1642	.852 21,6	.885 22,5	.840 21,3	.282 7,2	433.92MHz & 860-930MHz	290 @ 700MHz
CS25B1937	CA25B1937	1.182 30,0	.780 19,6	1.188 30,2	.425 10,8	433.92MHz & 860-930MHz	305 @ 700MHz
CS25B1500	CA25B1500	1.725 43,8	1.232 31,3	1.720 43,7	.960 24,4	433.92MHz & 860-930MHz	570 @ 700MHz
CS25B2000	CA25B2000	2.350 59,7	1.851 47,0	2.309 58,6	.960 24,4	433.92MHz & 860-930MHz	890 @ 700MHz
CS25B4000	CA25B4000	4.500 114,2	1.851 47,0	4.687 119,0	1.960 49,8	433.92MHz & 860-930MHz	590 @ 700MHz
CS20B1500	CA20B1500	1.725 43,8	1.232 31,3	1.720 43,7	.960 24,4	2.45GHz	per application
CS20B2000	CA20B2000	2.350 59,7	1.851 47,0	2.309 58,6	.960 24,4	2.45GHz	per application
CS20B4000	CA20B4000	4.500 114,2	1.851 47,0	4.687 119,0	1.960 49,8	2.45GHz	per application



flat cable clamp for flat cables

WITH OPTIONAL ADHESIVE MOUNTING. Ferrite assembly clamps over flat cables up to 64-conductor widths 3.24" (82,3mm). Optional adhesive pad mounts on bottom; or, may be mounted with flat-head screws through the .125" (3,0mm) diameter holes on 1.25" (31,8mm) centers in the bottom by temporarily removing the lower ferrite half.

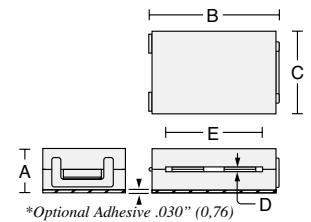

PART No.	w/adhesive	A	B	C	D	E	Target Frequency/Range	Impedance in Ohms
RC28B1729	RA28B1729	.670 17,0	2.030 51,6	1.312 33,3	.060 1,5	1.355 34,4	13.56MHz	200 @ 100MHz
RC28B2480	RA28B2480	.670 17,0	2.760 70,1	1.312 33,3	.060 1,5	2.047 52,0	13.56MHz	250 @ 100MHz
RC28B3012	RA28B3012	.670 17,0	3.260 82,8	1.312 33,3	.060 1,5	2.540 64,5	13.56MHz	286 @ 100MHz
RC28B4340	RA28B4340	.755 19,2	4.610 117,1	1.312 33,3	.104 2,6	3.240 82,3	13.56MHz	325 @ 100MHz
RC25B2480	RA25B2480	.700 17,8	2.760 70,1	1.312 33,3	.060 1,5	2.047 52,0	433.92MHz & 860-930MHz	390 @ 700MHz
RC25B4340	RA25B4340	.785 19,9	4.610 117,1	1.312 33,3	.104 2,6	3.240 82,3	433.92MHz & 860-930MHz	510 @ 700MHz
RC20B1729	RA20B1729	.700 17,8	2.030 51,6	1.312 33,3	.060 1,5	1.355 34,4	2.45GHz	per application
RC20B2480	RA20B2480	.700 17,8	2.760 70,1	1.312 33,3	.060 1,5	2.047 52,0	2.45GHz	per application



engineering kit #EK28B0032

BISECTED FERRITES FOR APPLICATIONS UP TO 1 GHz WITH PEAK PROPERTIES AT 250MHz.

Our most popular engineering kit! Contains a large assortment of various sizes of ferrite assemblies from catalog pages 10 through 21. Manufactured in the most frequently used universal #28 wideband material formulation for all applications up to 1 GHz.

All catalog items are in stock at all times for immediate delivery.



engineering kit #EK28B0021

SOLID FERRITES FOR APPLICATIONS UP TO 1 GHz WITH PEAK PROPERTIES AT 250MHz.

Sample assortment of twenty cylindrical and flat solid ferrite suppressors in universal #28 wideband material formulation for applications up to 1 GHz. Contains many of the cylindrical and flat rectangular designs shown on pages 15 and 19, including the "SM" shock mount versions.

See catalog pages 15 and 19 for all items available from stock for immediate delivery.



saddle beads® engineering kit #EK28B27SB

FERRITES FOR APPLICATIONS UP TO 1 GHz WITH PEAK PROPERTIES AT 250MHz.

A wide variety of common sizes of our unique half-toroid, half-bead, half-sleeve and plate shapes for round wire, flat wire and PC board components. Manufactured in the most frequently used universal #28 wideband material formulation for all applications up to 1 GHz.

See catalog page 20 for all items available from stock for immediate delivery.



engineering kit #EK33B0011, low frequency 30MHz peak

BISECTED FERRITES FOR APPLICATIONS FROM 1 TO 30MHz WITH PEAK PROPERTIES AT 30MHz.

Sample assortment containing nine of the most common configurations of ferrite assemblies manufactured in #33 material formulation. Specifically applicable in the 1-30 MHz range.

Contains part numbers TC33B0805, TC33B0984, CS33B1805, CV33B1984, FA33B2480, SS33B2033, SS33B2037, SS33B2032, SS33B2036. Other sizes available on a special order basis.

See catalog pages 22 and 23 for all items available from stock for immediate delivery. Most other catalog items are also available in this material on special order basis.



engineering kit #EK25B0012, high frequency 700MHz peak

BISECTED FERRITES FOR APPLICATIONS UP TO 1 GHz WITH PEAK PROPERTIES AT 700MHz.

Sample assortment of ten popular stock items manufactured in our newest #25 high frequency material. Effective to 1.2 GHz with peak properties at 700 MHz.

Contains part numbers TC25B0642, TC25B0937, CS25B1642, SA25B0121, CV25B1937, FA25B2480, SS25B2033, SS25B2032, SS25B2037, SS25B2036. Other sizes available on a special order basis.

See catalog pages 24 and 25 for all items available from stock for immediate delivery. Most other catalog items are also available in this material on special order basis.



engineering kit #EK20B0009, Bluetooth™

BISECTED AND SOLID FERRITES FOR APPLICATIONS CONCERNED WITH 2.45GHZ OPERATIONS.

Sample assortment of nine popular stock items manufactured in #20 material formulation. Specifically applicable in the 2.45GHz frequency area.

Contains part numbers 20B0562-2, 20B0736-0, 20R1260, 20R1575, FA20B2480, SS20B2034, SS20B2037, SS20B2033, SS20B2042.

See catalog pages 26 and 27 for all items available from stock for immediate delivery. Most other catalog items are also available in this material on special order basis.



suppression prototyping

Your lab is not complete without a selection of ferrite RFI-EMI suppressors on hand. Helpful during engineering evaluations, prototyping, emergencies, and eventually for final product compliance testing and documentation.

The engineering kits shown on page 30 contain a wide assortment of sizes, configurations and suppression levels for any insertion loss requirements.

The test fixtures shown below are indispensable problem-solving aids, useful in any laboratory.

When extra samples are required for your project, just a phone call to our customer service department will have them immediately on the way to you.

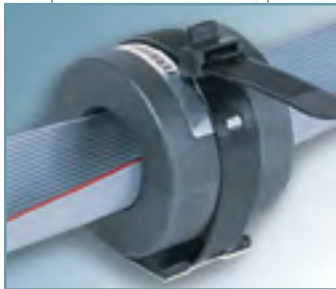

empirical test fixtures – WITH QUICK-RELEASE STRAP

A handy R&D/test device for determining if a ferrite suppressor is feasible in a given situation. With this massive amount of insertion loss material applied to a circuit, a rough estimate of attenuation effect can be previewed. Afterwards, a properly configured ferrite assembly can be determined. Install on any cable data signal circuit by reassembling ferrite halves within the plastic strap. Even flat ribbon cables pass through the large opening. Available in our four standard material formulas.

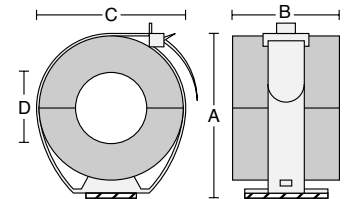

PART No.	A	B	C	D	MATERIAL	IMPEDANCE IN OHMS
ET28B2000	2.53 64,3	1.50 38,1	2.00 50,8	1.00 25,4	#28 formulation	380 @ 100MHz
ET33B2000	2.53 64,3	1.50 38,1	2.00 50,8	1.00 25,4	#33 formulation	210 @ 30MHz
ET25B2000	2.53 64,3	1.50 38,1	2.00 50,8	1.00 25,4	#25 formulation	890 @ 700MHz
ET20B2000	2.53 64,3	1.50 38,1	2.00 50,8	1.00 25,4	#20 formulation	per application



empirical test fixtures – IN FULLY ENCLOSED PLASTIC CASE

Another variation of the test fixture shown above – the same ferrite core encased in a heavy-duty hinged nylon plastic enclosure. A handy R&D/test device for determining if a ferrite suppressor is feasible in a given situation. With this massive amount of insertion loss material applied to a circuit, a rough estimate of attenuation effect can be previewed. Afterwards, a properly configured ferrite assembly can be determined. Install on any cable data signal circuit by clamping around the cable. Even flat ribbon cables pass through the large opening. Available in our four standard material formulas.

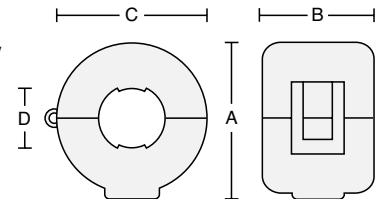

PART No.	A	B	C	D	MATERIAL	IMPEDANCE IN OHMS
CS28B2000	2.350 59,7	1.851 47,0	2.309 58,6	.960 24,4	#28 formulation	380 @ 100MHz
CS33B2000	2.350 59,7	1.851 47,0	2.309 58,6	.960 24,4	#33 formulation	210 @ 30MHz
CS25B2000	2.350 59,7	1.851 47,0	2.309 58,6	.960 24,4	#25 formulation	890 @ 700MHz
CS20B2000	2.350 59,7	1.851 47,0	2.309 58,6	.960 24,4	#20 formulation	per application



special purpose large toroid clamp

IN FULLY ENCLOSED PLASTIC CASE WITH 2.0" (50,8mm) I.D.

Similar to other "CS" Empirical Test Fixtures above, except with a 4.0" 101,6mm O.D. and a 2.0" 50,8mm I.D. ferrite core. Available in four standard material formulas.

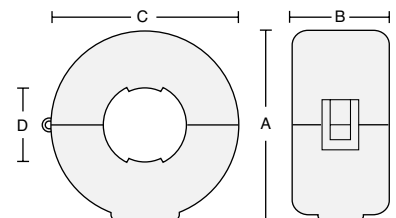

PART No.	A	B	C	D	MATERIAL	IMPEDANCE IN OHMS
CS28B4000	4.500 114,2	1.851 47,0	4.687 119,0	1.960 49,8	#28 formulation	290 @ 100MHz
CS33B4000	4.500 114,2	1.851 47,0	4.687 119,0	1.960 49,8	#33 formulation	140 @ 30MHz
CS25B4000	4.500 114,2	1.851 47,0	4.687 119,0	1.960 49,8	#25 formulation	590 @ 700MHz
CS20B4000	4.500 114,2	1.851 47,0	4.687 119,0	1.960 49,8	#20 formulation	per application



empirical test fixture – FOR FLAT CABLES AND FLEX-CIRCUITS

A high impedance R&D/test device for determining if a ferrite suppressor is feasible in a given situation. Specifically for flat cables and flex-circuits, with this massive amount of insertion loss material applied to a circuit the attenuation effect of the wideband ferrite core material can be previewed. Afterwards, a properly configured ferrite assembly can be determined. Installs on any cable data signal circuit up to 50-conductors by engaging the double clamps; quick-release design opens easily. Adhesive foam pads on bottom allow permanent mounting if desired. Available in our standard #28 wideband formula for frequencies from 10 MHz to 1 GHz.

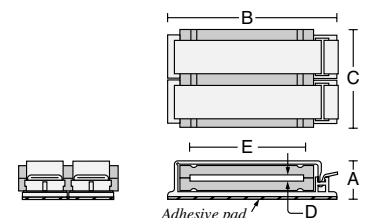

PART No.	A	B	C	D	E	IMPEDANCE IN OHMS
ET28B3000	.800 20,3	3.700 94,0	1.500 38,1	.060 1,5	2.540 64,5	370 @ 100MHz

Attenuation Properties by Part Number

IMPEDANCE VS. FREQUENCY-#28 MATERIAL.

The #28 formulation of suppression material is our most common product. It is an excellent wideband general purpose insertion loss absorber for frequencies from 10 MHz up to 1 GHz.

All of the impedance data below applies to the FerriShield® series which are specified by "28B" or the following alpha prefixes: TC, CS, CA, CW, CF, CV, FA, FF, FD, FX, IL, BA, BC, ET, SE, SA, PM, JB, CG, UG, HF, HI, HW, HA, SM, WC, CC, AC, PC, HC, HD, RC, RA, SF, SD, SS and USB. For specific performance by part number, find the alpha-numeric designation on the charts below according to the last seven digits of each catalog part number; i.e., for part number "CS28B1937" see "28B1937" on the chart.



IMPEDANCE VS. FREQUENCY-#33 MATERIAL.

The #33 formulation of suppression material is specifically applicable from 1 to 30 MHz with a decreasing effect beyond that range. The part numbers shown below are standard items available from stock and are the most commonly used configurations for those frequencies. Other sizes are available by special order.

All of the impedance data below applies to the FerriShield® series which are specified by "33B" or the following alpha prefixes: TC, CS, CA, CW, CF, CV, FA, FF, FD, ET, RC, RA, SE, SA and SS. For specific performance by part number, find the alpha-numeric designation on the charts below according to the last seven digits of each catalog part number, i.e. for part number "SS33B2032" see "33B2032" on the chart.



IMPEDANCE VS. FREQUENCY-#25 MATERIAL.

The #25 formulation of suppression material is designed to address frequencies resulting from microprocessor speeds above 100MHz and harmonics peak interference at 700MHz with some attenuation effect up to 1.2GHz. Most of the product styles in this catalog are available by special order within a convenient lead time.

Impedance data for standard stock items is shown below. They are available in the component assemblies with the following alpha prefixes: TC, CS, CA, CW, CF, CV, FA, FF, FD, ET, RC, RA, SE, SA, IL and SS.

All attenuation data is derived from tests using an HP4191A attenuation analyzer with spring clip or binding post fixturing, and does not include the test wire resistance. All impedance readings are shown at nominal ±10% at 3 standard deviations from the mean.

Material Properties

Formula	Description	Application	Permeability μ_i	B_s @ 10 Oe Gauss	Loss Factor ($1\mu_i^2$) x 10 ⁻⁶	Curie Temp. °C	Vol. Res. ohm-cm	Temperature Factor (20°C to 100°C) (x 10 ³) per °C
28 Material	Most popular wideband	1MHz-1GHz, 250MHz peak	850	3350	120 @ 1.0MHz	≥ 175	x 10 ⁵	< 7
33 Material	Low frequency	1MHz-60MHz, 30MHz peak	2700	4800	7 @ .1MHz	≥ 200	x 10 ²	< 7
25 Material	High frequency	1MHz-1.2GHz, 700MHz peak	125	3650	32 @ 2.5MHz	≥ 225	x 10 ⁸	< 7
20 Material	Microwave	2.45GHz peak	20	2700	500 @ 100.0MHz	≥ 510	x 10 ³	< 7

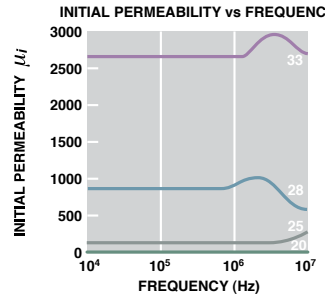
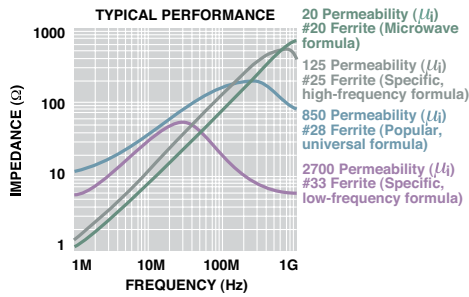
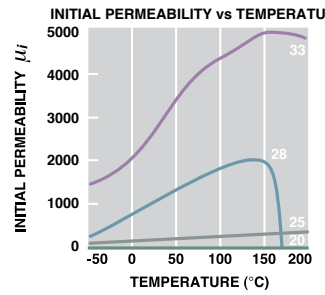
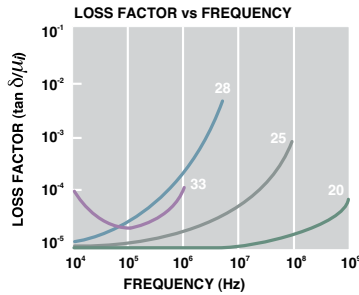

CABLE SIZE BY PART NUMBER The maximum recommended cable size or cable bundle diameter is shown below for each part number. A range of sizes indicates that the suppressor has a variable opening.

Series	Size	Maximum recommended cable size-in. mm
TC, ET	0550	.214 5,4 dia.
BA, BC	0617	.276 7,0 dia.
IL	0642	.320 8,1 dia.
	0805	.404 10,3 dia.
	0937	.449 11,4 dia.
	1123	.543 13,8 dia.
	0984	.591 15,0 dia.
	1251	.750 19,1 dia.
	1501	.750 19,1 dia.
	1500	1.000 25,4 dia.
	2000	1.000 25,4 dia.
	0138-7	.034 0,8 dia.
Special Purpose	0137-3	.051 1,3 dia.
Solid	0200-4	.062 1,6 dia.
Beads, PM	0300-0	.069 1,8 dia.
	0250-1	.125 3,2 dia.
	0350-1	.170 4,3 dia.
	0355-0	.187 4,8 dia.
	0385-2	.038 0,9 dia.
	0375-3	.200 5,0 dia.
	0500-3	.312 7,9 dia.
	0562-2	.250 6,3 dia.
	0563-0	.285 7,3 dia.
	0625-0 and 0625-1	.310 7,9 dia.
	0626-0	.133 3,4 dia.
	0672-0	.345 8,8 dia.
	0686-2	.375 9,5 dia.
	0735-0	.400 10,2 dia.
	0736-0	.410 10,4 dia.
	1020-1	.505 12,8 dia.
	1102-1	.630 16,0 dia.
	1250-2	.750 19,0 dia.
	1387-1	.880 22,4 dia.
	2000-3	1.000 25,4 dia.
JB PM	0010	.060 1,5 to .120 3,1 dia.
	3375	.192 4,8 dia.
	0625	.310 7,9 dia.
	1625	.310 7,9 dia.
	0686	.375 9,5 dia.
	2027	.085 2,2 dia.
SS, AS	2034	.125 3,2 to .170 4,3 dia.
HI, HF	2034	.125 3,2 to .170 4,3 dia.
HW, HA,	2031	.200 5,1 dia.

Series	Size	Maximum recommended cable size-in. mm
USB	2035-3	3 holes ea. @ .203 5,2 dia.
	2030	.235 6,0 dia.
	2033	.300 7,6 dia.
	2037	.210 5,3 to .300 7,6 dia.
	2035-2	2 holes ea. @ .335 8,5 dia.
	2036	.380 9,7 dia.
	2041	.400 10,2 dia.
	2042	.250 6,3 to .400 10,2 dia.
	2032	.250 6,3 to .500 12,7 dia.
	2038	.440 11,3 dia.
	2039	.250 6,3 to .435 11,0 dia.
	2040	.500 12,7 dia.
	2035	.730 18,5 dia.
	2043	.730 18,5 dia.
	2044	.500 12,7 to .710 18,0 dia.
	2035-15	15 conductor, .038 x .75 1,0 x 19,1.
	ET, FA	0071
FF, FD	0121	20 conductor, .060 x 1.00 1,5 x 25,4
FC, SE	0146	26 conductor, .060 x 1.25 1,5 x 31,8
SA, RC	0221	40 conductor, .060 x 2.00 1,5 x 50,8
RA	0765	10 conductor, .038 x .500 1,0 x 12,7
	1240	20 conductor, .040 x 1.00 1,0 x 25,4
	1265	20 conductor, .038 x 1.00 1,0 x 25,4
	1729	26 conductor, .060 x 1.25 1,5 x 31,8
	1785	26 conductor, .060 x 1.25 1,5 x 31,8
	2265	40 conductor, .038 x 2.00 1,0 x 50,8
	2375	34 conductor, .060 x 1.70 1,5 x 43,2
	2440	40 conductor, .280 x 2.00 7,1 x 50,8
	2480	40 conductor, .060 x 2.00 1,5 x 50,8
	2500	40 conductor, .060 x 2.00 1,5 x 50,8
	2940	50 conductor, .280 x 2.50 7,1 x 63,5
	3000	50 conductor, .060 x 2.50 1,5 x 63,5
	3012	50 conductor, .060 x 2.50 1,5 x 63,5
	3500	60 conductor, .060 x 3.00 1,5 x 76,2
	4340	64 conductor, .100 x 3.20 2,5 x 8,2
FX	0984-0	.030 x .700 0,76 x 17,8
	0984-2	.030 x .700 0,76 x 17,8
	1261-2	.030 x .980 0,76 x 24,9
	1450-1	.030 x 1.155 0,76 x 29,3
	0984-0	.018 x 1.29 95,0 x 32,8

Series	Size	Maximum recommended cable size-in. mm	
SM	0760	10 conductor, .051 x .510 1,3 x 13,0	
	0785	10 conductor, .145 x .500 3,7 x 12,7	
	and	1101	18 conductor, .059 x .900 1,5 x 22,8
		1127/218	conductor, .060 x .900 1,5 x 22,8
	Rectangular Solids	1260	20 conductor, .051 x 1.01 1,3 x 25,7
		1531	20 conductor, .210 x 1.00 12,9 x 25,4
		1575	26 conductor, .051 x 1.30 1,3 x 33,0
		1775	26 conductor, .060 x 1.30 1,5 x 33,0
		1953	34 conductor, .059 x 1.70 1,5 x 43,1
		2170	35 conductor, .050 x 1.72 1,2 x 43,7
2002		40 conductor, .300 x 2.00 7,6 x 50,8	
1779		40 conductor, .066 x 2.00 1,6 x 50,8	
2300		40 conductor, .051 x 2.05 1,3 x 52,1	
3149		50 conductor, .075 x 2.70 1,9 x 68,5	
CS, CA CW, CF	1642 and 0642	.300 7,6 dia.	
	1805 and 0805	.345 8,7 dia.	
	1937 and 0937	.400 10,2 dia.	
	1984 and 0984	.520 13,2 dia.	
	1501	.750 19,1 dia.	
	1500	1.000 25,4 dia.	
CV	2000	1.000 25,4 dia.	
	4000	2.000 50,8 dia.	
	1642	.120 3,0 to .300 7,6 dia.	
	1805	.120 3,0 to .345 8,7 dia.	
	1937	.200 5,1 to .400 10,2 dia.	
	1984	.200 5,1 to .500 12,7 dia.	
Toroids	0870-0	.540 13,7 dia.	
	0999-0	.610 15,5 dia.	
	1225-0	.750 19,1 dia.	
	1417-0	.905 23,0 dia.	
	2400-0	1.400 35,6 dia.	
	2275	1.335 33,9 dia.	
Extra Large Toroids	3170	1.645 41,8 dia.	
	2945	1.775 45,1 dia.	
	4100	2.650 67,3 dia.	
	5950	3.675 93,3 dia.	
	5945	4.330 110,0 dia.	
	9210	6.665 169,3 dia.	
SB	all	per application - see page 14	



ScanEM probes

NEAR-FIELD DETECTORS FOR EASY MEASUREMENT OF ELECTROMAGNETIC EMISSIONS

Shorten your development schedule and eliminate the need for product redesign by using proper EMC tools from the beginning of the project. ScanEM probes are diagnostic instruments for detecting, locating and measuring electromagnetic emissions. They are professional tools that don't require you to be an EMC expert to completely address emission compliance. They can reliably predict electromagnetic behavior of your products and locate emission sources in a matter of seconds. They detect the presence of an electromagnetic field and provide audio and visual indication of its relative strength either working by themselves, or as broadband active probes with any spectrum analyzer, oscilloscope or multimeter.

- Pinpoint exact sources of EMI
- Detect electric and magnetic fields separately
- Self-contained: palm-sized, no cords, no power supply or amplifier
- Audio output: tone changes indicate field strength
- LED color bar verifies relative field strength
- Squelch feature nullifies ambient to locate problem areas
- Output to spectrum analyzer or oscilloscope if desired
- DC output to multimeter for DC voltage as a function of field strength
- No disturbance of circuit under test - does not touch the circuit

WHY NEAR-FIELD TESTING?

The standard radiated EMC test is done in the far field at 10'-0" (3M) from the product. This shows if there is a failure, but does not pinpoint the source of the problem. A near-field probe is a close-up inspection which permits quick product scanning for problem areas.

- PC board traces
- Trouble shooting
- Production quality control
- Service and repair
- Prequalification
- Cables, connectors – to a single circuit or pin
- Production quality control
- Service and repair
- Non-contact diagnostics – no circuit loading

A day spent at the beginning of a project preventing EMC problems saves days, even weeks, fixing these problems at the end.



CTK015 – SCANEM-C PROBE SET

Complete kit contains electric and magnetic near-field probes. See specifications in chart below. Includes batteries, user guide, storage case and 6'-0" (1,8M) cable with adapters for connecting to spectrum analyzer, oscilloscope or multimeter. Free ferrite engineering kit included. See information at lower right.

CTK015 W/ BOTH PROBES	PROBE	PROBE
Parameters	CTM030	CTM032
Fields	Electric	Magnetic
Frequency Response	2MHz - 2GHz	1MHz - 1GHz
RF Output	Yes	Yes
DC Output to a multimeter	Yes	Yes
Sensitivity (typical)	-10dBm/(V/m)	-20dBm/mA
Connector	SMB/BNC	SMB/BNC
Dimensions (approx.)	6.18" x 1.21" x 0.76" (157 x 31 x 20mm)	6.18" x 1.21" x 0.76" (157 x 31 x 20mm)
Weight (approx.)	2.25oz (65g)	2.25oz (65g)
Battery (included)	2 x AAA	2 x AAA
LED Bar Graph	5 LED color bar	5 LED color bar
Audio Indication	Speaker (tone pitch proportional to the field strength)	



CTK031 – EMC COMPLIANCE ENGINEERING KIT WITH DEMO FIXTURE

Contains both CTM030 electric and CTM032 magnetic near-field probes shown above along with a step-by-step guide, an EMC Demo Fixture, and cables with adapters for spectrum analyzer, oscilloscope or multimeter. Free ferrite engineering kit included. See information at lower right.



DEMO FIXTURE



Observe how a ferrite reduces emission



Verify the effectiveness of shielding



FREE #EK28B0032 FERRITE ENGINEERING KIT WITH EITHER SCANEM PROBE KIT PURCHASE

Our popular, wideband assortment of 32 unique configurations for EMI cable suppression.

Installation Guidelines

FerriShield® suppressors offer the finest performance alternatives by way of universal packaging, specific-purpose and general-purpose formulations. There are a few simple guidelines to assure expected results.

1. Cable Size

Refer to the chart on the page 33 for maximum recommended cable (or cable bundle) diameter. More than one cable may be inserted through the core opening since each circuit reacts with the ferrite material independently.

Consider the double loop knot shown in Attachment section below for snug attachment while greatly increasing the attenuation effect due to the increased magnetic path length. See also page 6, figures 3 and 4 for related technical information.

2. Closure

A tight fit between the cable outside dimensions; i.e. O.D., and the ferrite inside dimensions, i.e. I.D., will create the most effective magnetic path and a correspondingly higher attenuation ratio. Conversely, a loose fit is acceptable for many reasons, principally if a larger ferrite is desired, or a purpose-fit slack cable for tension control, flexing, etc.

3. Position

The suppressor should normally be located close to the cable termination where it exits the electronic enclosure.

Where a cable connects two enclosures containing RF sources, a suppressor on each end may be required.

For circuits within an enclosure, a position close to the RF source is best; however, other locations along the circuit may work just as well. This provides the opportunity to allow the suppressor, when affixed to the enclosure, to function also as a cable routing guide. See "Attachment" below for alternatives.

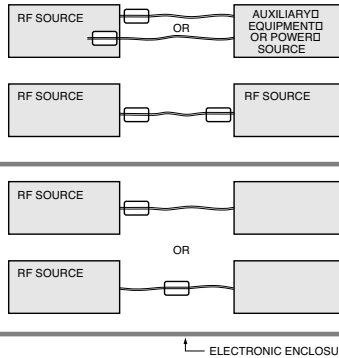

4. Attachment

Consider the various attachment alternatives shown below.



Tight grip on cable



Double loop knot



Hardware: screw, rivet



Press-fit tabs



Pressure sensitive adhesive



Cable tie wrap



Side-by-side double loop for flat cables

Each part number is a standard stock item and is carried in our inventories at all times for immediate delivery.

Part Number	Page #	Part Number	Page #	Part Number	Page #	Part Number	Page #
20B0562-2	26	AS20B2037	26,29	CF28B0937	11	FA20B1729	27
20B0736-0	26	AS20B2041	26,29	CF28B0984	11	FA20B2480	27
20R1260	27	AS20B2042	26,29	CF28B1500	10	FA25B0121	25
20R1575	27	AS25B2030	24,29	CF28B1501	10	FA25B2480	25
21T3350	15	AS25B2032	24,29	CF28B1642	10	FA28B0071	17
21T3937	15	AS25B2033	24,29	CF28B1805	10	FA28B0121	17
21T4335	15	AS25B2036	24	CF28B1937	10	FA28B1240	17
28B0137-3	15	AS25B2037	24,29	CF28B1984	10	FA28B1265	17
28B0138-7	15	AS25B2040	24	CF28B2000	10	FA28B1729	17
28B0200-4	15	AS28B2027	12	CS20B1500	26,29	FA28B1785	18
28B0250-1	15	AS28B2030	12,29	CS20B2000	26,29,31	FA28B2265	17
28B0300-0	15	AS28B2031	12	CS20B4000	26,29,31	FA28B2375	17
28B0350-0	15	AS28B2032	12,29	CS25B1500	24,29	FA28B2480	17
28B0355-0	15	AS28B2033	12,29	CS25B1642	24,29	FA28B2500	18
28B0375-3	15	AS28B2034	12,29	CS25B1937	24,29	FA28B2940	21
28B0385-2	15	AS28B2035	12,14	CS25B2000	24,29,31	FA28B3000	18
28B0562-2	15	AS28B2035-15	18	CS25B4000	24,29,31	FA28B3012	17
28B0563-0	15	AS28B2035-2	14	CS28B0642	11	FA33B2480	23
28B0625-0	15	AS28B2035-3	14	CS28B0805	11	FC20B1729	27
28B0625-1	15	AS28B2036	12	CS28B0937	11	FC20B2480	27
28B0626-0	15	AS28B2037	12,29	CS28B0984	11	FC25B0121	25
28B0672-0	15	AS28B2040	12	CS28B1500	10,29	FC25B2480	25
28B0686-2	15	AS28B2041	12,29	CS28B1501	10,29	FC28B0071	17
28B0735-0	15	AS28B2042	12,29	CS28B1642	10,29	FC28B0121	17
28B0736-0	15	AS28B2043	12	CS28B1805	10,29	FC28B1240	17
28B0785	19,21	AS28B2044	12	CS28B1937	10,29	FC28B1729	17
28B0870-0	15	AS33B2030	22	CS28B1984	10,29	FC28B1785	18
28B0999-0	15	AS33B2032	22	CS28B2000	10,29,31	FC28B2375	17
28B1020-1	15	AS33B2033	22	CS28B4000	10,29,31	FC28B2480	17
28B1101	19	AS33B2035	22	CS33B1805	22	FC28B2500	18
28B1102-1	15	AS33B2036	22	CS33B1984	22	FC28B3000	18
28B1225-0	15	AS33B2037	22	CS33B2000	22,31	FC28B3012	17
28B1250-2	15	AS33B2040	22	CS33B4000	22,31	FC33B2480	23
28B1387-1	15	BA28B1251	14	CTK015	34	FD25B2480	25
28B1417-2	15	BA28B1500	14	CTK031	28,34	FD28B2375	17
28B1775	19	BA28B1501	14	CV28B1642	10	FD28B2480	17
28B1775-1	19	BC28B1251	14	CV28B1805	10	FD28B2500	18
28B1779	19	BC28B1500	14	CV28B1937	10	FD28B3000	18
28B2000-3	15	BC28B1501	14	CV28B1984	10	FD28B3012	17
28B2002	19,21	CA20B1500	29	CW28B0642	11	FD33B2480	23
28B2170-1	19	CA20B2000	29	CW28B0805	11	FF25B0121	25
28B2275	15	CA20B4000	29	CW28B0937	11	FF25B2480	25
28B2400-0	15	CA25B1500	29	CW28B0984	11	FF28B0121	17
28B2945	15	CA25B1642	29	CW28B1500	10	FF28B1240	17
28B3149	19	CA25B1937	29	CW28B1501	10	FF28B1265	17
28B3170	15	CA25B2000	29	CW28B1642	10	FF28B1729	17
28B4100	15	CA25B4000	29	CW28B1805	10	FF28B1785	18
28B5945	15	CA28B0642	11	CW28B1937	10	FF28B2375	17
28B5950	15	CA28B0805	11	CW28B1984	10	FF28B2440	21
28B9210	15	CA28B0937	11	CW28B2000	10	FF28B2480	17
28R0760	19	CA28B0984	11	EK20B0009	30	FF28B2500	18
28R1127	19	CA28B1500	10,29	EK25B0012	30	FF28B2940	21
28R1127-2	19	CA28B1501	10,29	EK28B0021	30	FF28B3000	18
28R1260	19	CA28B1642	10,29	EK28B0032	30	FF28B3012	17
28R1531	19,21	CA28B1805	10,29	EK28B27SB	30	FF33B2480	23
28R1575	19	CA28B1937	10,29	EK33B0011	30	FX28R0984-0/A	19
28R1953	19	CA28B1984	10,29	ET20B2000	31	FX28R0984-2/A	19
28R2300	19	CA28B2000	10,29	ET25B2000	31	FX28R1261-2/A	19
AS20B2030	26,29	CA28B4000	29	ET28B2000	31	FX28R1450-1/A	19
AS20B2033	26,29	CF28B0642	11	ET28B3000	31	FX28R1457-4/A	19
AS20B2034	26,29	CF28B0805	11	ET33B2000	31		

Each part number is a standard stock item and is carried in our inventories at all times for immediate delivery.

Part Number	Page #	Part Number	Page #	Part Number	Page #	Part Number	Page #
HA28B2038	13	SB28B0071	20	SB28B2043AT/AB	20	SS25B2036	24
HA28B2039	13	SB28B0071AB/AT	20	SB28B2100	20	SS25B2037	24,29
HF28B2038	13	SB28B0121	20	SB28B2100-1	20	SS25B2040	24
HF28B2039	13	SB28B0121AB/AT	20	SB28B2100-1AB	20	SS28B2027	12
HI28B2038	13	SB28B0146	20	SB28B2100AB	20	SS28B2030	12,29
HI28B2039	13	SB28B0146AB/AT	20	SB28B2375	20	SS28B2031	12,14
HW28B2038	13	SB28B0221	20	SB28B2375AT/AB	20	SS28B2032	12,29
HW28B2039	13	SB28B0221AT/AB	20	SB28B2480	20	SS28B2033	12,29
IL25B0642W/G/B/K	24	SB28B0500	20	SB28B2480AT/AB	20	SS28B2034	12,14,29
IL28B0642W/G/B/K	12	SB28B0500-1	20	SB28B3012	20	SS28B2035	12,14
JB28B0010	12	SB28B0500-1AB	20	SB28B3012AT/AB	20	SS28B2035-15	18
PM28B0625	14	SB28B0500AB	20	SB28B3500	20	SS28B2035-2	14
PM28B0686	14	SB28B0550	20	SB28B3500AT/AB	20	SS28B2035-3	14
PM28B0736	14	SB28B0550AB	20	SB28B4340	20	SS28B2036	12
PM28B1625	14	SB28B0617	20	SB28B4340AT/AB	20	SS28B2037	12,29
PM28B3375	14	SB28B0617AB	20	SB28B5630	14,21	SS28B2040	12
RA20B1729	27,29	SB28B0642	20	SB28B5630A	14,21	SS28B2041	12,29
RA20B2480	27,29	SB28B0642AB	20	SE20B1729	27	SS28B2042	12,29
RA25B2480	25,29	SB28B0805	20	SE20B2480	27	SS28B2043	12
RA25B4340	25,29	SB28B0805AB	20	SE25B0121	25	SS28B2044	12
RA28B0765	16	SB28B0875	20	SE25B2480	25	SS33B2030	22
RA28B1265	16	SB28B0875-1	20	SE25B4340	25	SS33B2032	22
RA28B1729	16,29	SB28B0875-1AB	20	SE28B0071	17	SS33B2033	22
RA28B2265	16	SB28B0875AB	20	SE28B0121	17	SS33B2035	22
RA28B2480	16,29	SB28B0937	20	SE28B0146	17	SS33B2036	22
RA28B3012	16,29	SB28B0937AB	20	SE28B0221	17	SS33B2037	22
RA28B4340	16,29	SB28B0984	20	SE28B1240	17	SS33B2040	22
RA33B2480	23	SB28B0984AB	20	SE28B1729	17	TC20B1500	26
RA33B4340	23	SB28B1055	20	SE28B2480	17	TC20B2000	26
RC20B1729	27,29	SB28B1055-1	20	SE28B3012	17	TC25B0642	24
RC20B2480	27,29	SB28B1055-1AB	20	SE28B3500	17	TC25B0937	24
RC25B2480	25,29	SB28B1055AB	20	SE28B4340	17	TC25B1500	24
RC25B4340	25,29	SB28B1123	20	SE33B2480	23	TC25B2000	24
RC28B0765	16	SB28B1123AB	20	SE33B4340	23	TC28B0550	11
RC28B1265	16	SB28B1251	20	SM20R1260	27	TC28B0617	11
RC28B1729	16,29	SB28B1251AB	20	SM20R1575	27	TC28B0642	11
RC28B2265	16	SB28B1500	20	SM28B0785	19,21	TC28B0805	11
RC28B2480	16,29	SB28B1500AB	20	SM28B1101	19	TC28B0937	11
RC28B3012	16,29	SB28B1501	20	SM28B1775	19	TC28B0984	11
RC28B4340	16,29	SB28B1501AB	20	SM28B1775-1	19	TC28B1123	11
RC33B2480	23	SB28B1729	20	SM28B1779	19	TC28B1251	11
RC33B4340	23	SB28B1729AT/AB	20	SM28B2002	19,21	TC28B1500	11
SA20B1729	27	SB28B2000	20	SM28B2170-1	19	TC28B1501	11
SA20B2480	27	SB28B2000AB	20	SM28B3149	19	TC28B2000	11
SA25B0121	25	SB28B2027	20	SM28R0760	19	TC33B0805	22
SA25B2480	25	SB28B2027AT/AB	20	SM28R1127	19	TC33B0984	22
SA25B4340	25	SB28B2030	20	SM28R1127-2	19	TC33B2000	22
SA28B0071	17	SB28B2030AT/AB	20	SM28R1260	19	USB28B2034	13
SA28B0121	17	SB28B2031	20	SM28R1531	19,21	USB28B2034A	13
SA28B0146	17	SB28B2031AT/AB	20	SM28R1575	19	USB28B2034K	13
SA28B0221	17	SB28B2032	20	SM28R1953	19	USB28B2034KA	13
SA28B1240	17	SB28B2032AT/AB	20	SM28R2300	19		
SA28B1729	17	SB28B2034	20	SS20B2030	26,29		
SA28B2480	17	SB28B2034AT/AB	20	SS20B2033	26,29		
SA28B3012	17	SB28B2035	20	SS20B2034	26,29		
SA28B3500	17	SB28B2035AT/AB	20	SS20B2037	26,29		
SA28B4340	17	SB28B2039	20	SS20B2041	26,29		
SA33B2480	23	SB28B2039AT/AB	20	SS20B2042	26,29		
SA33B4340	23	SB28B2041	20	SS25B2030	24,29		
SB28B0010	20	SB28B2041AT/AB	20	SS25B2032	24,29		
SB28B0010AB/AT	20	SB28B2043	20	SS25B2033	24,29		

WE'VE GOT YOU COVERED

Reliable Board, Enclosure and Cable Shielding Solutions

Leader Tech is a world-leading innovator and US-based manufacturer of EMI shielding products for circuit boards, enclosures and cables. In addition to our best selling standard, modified standard and custom CBS shields, Leader Tech offers an expansive line of beryllium copper fingerstock gaskets, conductive elastomers, advanced RF absorber materials and EMI/RFI ferrites.



EMI Enclosure Solutions Catalog



CBS Circuit Board Shielding Catalog

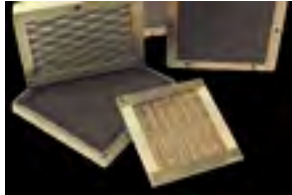

LEADERTECH SHIELDING PRODUCTS

Board Level Shielding

- Standard and Multi-Cavity CBS
- Modified Standard Options
- Custom Circuit Board Shields

FerriShield Ferrites

- Snap-On Bisected & Solid Bead Ferrites
- Round & Flat Styles for Cables, Wires and Flex Circuits
- Low, High, Microwave and Wideband Frequency-Specific Material

Enclosure Shielding

- BeCu Fingerstock Gaskets
- TechSIL 5000 Conductive Elastomers
- Conductive Fabric Shielding Gaskets
- TechSIL 8000 Oriented Wire Gaskets
- TechMESH Knitted Wire Gaskets
- TechMESH Combo Strip & Gaskets
- TechVent Honeycomb Shielding Panels

EMI PROBLEM?

Our sales engineers are waiting for your call: 866-TECH-EMI (866-832-4364)

Visit our web site today to browse our complete product line, download literature and find your local sales engineer or sales representative! www.leadertechinc.com



STANDARD PRODUCTS

Part Number Explanation

Part Style	Material Type	Ferrite Shape	Ferrite Size	Special Option
SS	28	B	2031	K

Color

All plastic components are supplied in PMS #413 computer gray unless shown in photos as natural white or black. Black is optional where indicated.

Custom Products

Engineering support is always available for special designs and evaluations.

Samples

Most items on catalog pages 10 through 27 are available from stock on a complimentary basis.

Commercial and Government Entity Code (CAGE CODE): 4J674

Quality System

ISO 9001:2008 certified.

Delivery

All items are normally available from stock at all times for immediate delivery.

RoHS Directive

All FerriShield products are in compliance with the European Commission RoHS Directive, Restriction of use of certain Hazardous Substances, dated July, 1 2006. FerriShield products do not contain any of the six restricted substances; namely, lead, cadmium, mercury, hexavalent chromium, PBB or PBDE flame retardant.

Customer Service

For quotes, technical information or personal assistance, contact:



12420 Race Track Road, Tampa, Florida 33626
 www.leadertechinc.com • sales@leadertechinc.com
 866.TECH.EMI (866.832.4364) • Local: 813.855.6921
 Fax: 813.855.3291



ISO 9001: 2008
CERTIFIED



STATEMENT OF LIEU OF WARRANTY: All technical information and data in this document is based on tests and is believed to be accurate and reliable. Nevertheless, since the products described herein are not provided to conform with mutually accepted specifications and the use thereof is unknown, the manufacturer and seller of the products do not guarantee results, freedom from patent infringement, or suitability of the products for any application thereof. The manufacturer and seller of the products described in this document will provide all possible technical assistance and will replace any products proven defective. No statement or recommendations made by the manufacturer or seller not contained herein shall have any force of effect unless in conformity with an agreement signed by an officer of the seller and manufacturer. Product testing by the purchaser is recommended in order to confirm expected results.

www.LEADERTECHINC.COM

A passion in all we do



**LEADER
TECH** 
a HEICO company

12420 Race Track Rd.
Tampa, Florida 33626

866.TECH.EMI (866.832.4364)

Tel: 813.855.6921

Fax: 813.855.3291

www.leadertechinc.com

F071

ISO 9001: 2008
CERTIFIED

 **RoHS**
COMPLIANT



Стандарт Электрон Связь

Мы молодая и активно развивающаяся компания в области поставок электронных компонентов. Мы поставляем электронные компоненты отечественного и импортного производства напрямую от производителей и с крупнейших складов мира.

Благодаря сотрудничеству с мировыми поставщиками мы осуществляем комплексные и плановые поставки широчайшего спектра электронных компонентов.

Собственная эффективная логистика и склад в обеспечивает надежную поставку продукции в точно указанные сроки по всей России.

Мы осуществляем техническую поддержку нашим клиентам и предпродажную проверку качества продукции. На все поставляемые продукты мы предоставляем гарантию .

Осуществляем поставки продукции под контролем ВП МО РФ на предприятия военно-промышленного комплекса России , а также работаем в рамках 275 ФЗ с открытием отдельных счетов в уполномоченном банке. Система менеджмента качества компании соответствует требованиям ГОСТ ISO 9001.

Минимальные сроки поставки, гибкие цены, неограниченный ассортимент и индивидуальный подход к клиентам являются основой для выстраивания долгосрочного и эффективного сотрудничества с предприятиями радиоэлектронной промышленности, предприятиями ВПК и научно-исследовательскими институтами России.

С нами вы становитесь еще успешнее!

Наши контакты:

Телефон: +7 812 627 14 35

Электронная почта: sales@st-electron.ru

Адрес: 198099, Санкт-Петербург,
Промышленная ул, дом № 19, литера Н,
помещение 100-Н Офис 331