



RN-XV-RD2-EVAL-UM

# RN-XV-RD2 Evaluation Board

© 2012 Roving Networks. All rights reserved.  
RN-XV-RD2-EVAL-UM-1.01Version 1.0 9/28/2012

**USER MANUAL**

## OVERVIEW

---

This document describes the hardware and software setup for Roving Networks RN-XV-RD2 evaluation board, which allows you to evaluate the RN-XV 802.11 b/g module. The RN-XV module, which is sold separately, mounts to the evaluation board and contains the RN-171 Wi-Fi module. Table 1 describes the board's components.

*Table 1. RN-XV-RD2 Evaluation Board Components*

Component	Description
Connector socket for the RN-XV	The RN-XV module's pins slide into the socket.
Three status LEDs	These LEDs mimic the LEDs on the RN-XV.
Four pushbutton switches	These switches are hard-wired to the RN-XV module and provide reset, ad hoc/WPS mode, access to sensor 2, and access to GPSW (GPIO14).
Two 10-amp, 250-V relays	The board has two relays with connectors (J7 and J6) that you can connect to a variety of electronics or appliances. After you have programmed the module, you can operate the connected electronics remotely over Wi-Fi.
Built-in temperature sensor	The board includes a temperature sensor (SEN5) that allows the module to wake or sleep depending on the ambient temperature.
External temperature probe connector	You can attach an external temperature probe to the board using the connector at SEN3.
USB cable	A USB cable connected to the board allows you to connect directly from the board to your computer, e.g., for programming the module over the UART.
10 GPIO pins	The board contains access to 10 GPIO pins via the 3.3-V headers at J3 and J5.
Voltage regulator	The voltage regulator controls the voltage levels on the board.

You can configure and program the WiFly module using the command interface, create connections, and transfer data. The command interface is made up of simple ASCII commands. See "Resources & Related Documents" on page 15 for information on available documentation.

### Evaluation Board Description

The RN-XV-RD2 evaluation board connects to your computer using a USB cable. To evaluate the RN-XV module on the evaluation board, you need a computer with a USB port running either the Microsoft Windows or Mac OS-X operating system.

**NOTE:** Before beginning your evaluation, you must install the FTDI drivers for the USB cable. You can download the drivers (as well as other tools and utilities) from the Roving Networks website at <http://www.rovingnetworks.com/support.php>.

Figure 1 shows the RN-XV-RD2 evaluation board and pin information. Table 2 describes the LED indicators.

Figure 1. RN-XV-RD2 Evaluation Board

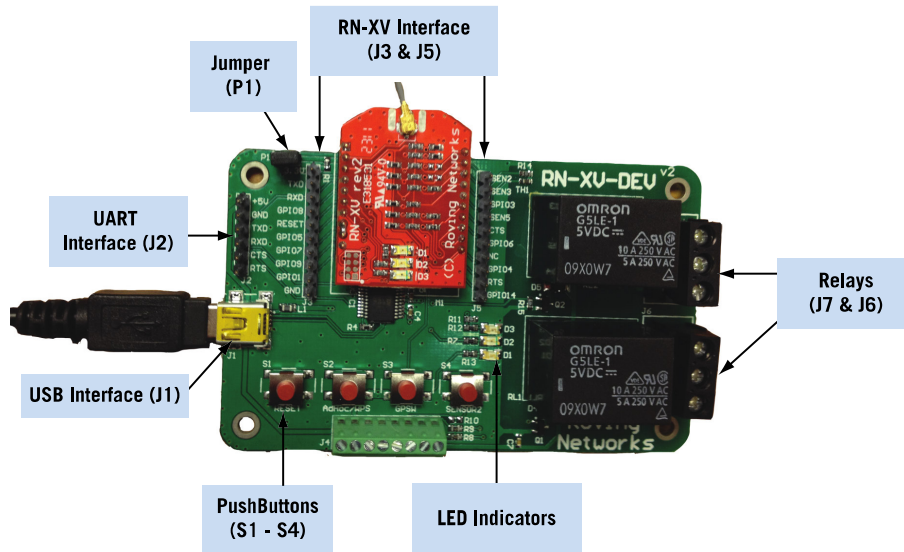

**UART Interface (J2)**



RX - input to evaluation board  
TX - output from evaluation board

Pin	Description
1	VBUS (5 V)
2	GND
3	RXD
4	TXD
5	RTS
6	CTS

**RN-XV Interface (J3)**



RX - input to evaluation board  
TX - output from evaluation board

Pin	Description
1	3.3 VDC output
2	TXD
3	RXD
4	GPIO8
5	RESET
6	GPIO5
7	GPIO7
8	GPIO9
9	GPIO1
10	GND

**RN-XV Interface (J5)**

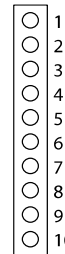

RX - input to evaluation board  
TX - output from evaluation board

Pin	Description
1	Sensor 2 (3.3-V tolerant)
2	Sensor 3 (3.3-V tolerant)
3	GPIO3
4	Sensor 5 (3.3-V tolerant)
5	CTS
6	GPIO6
7	Unused
8	GPIO4
9	RTS
10	GPIO14

**Table 2. RN-XV-RD2 Evaluation Board LED Indicators**

Condition	Red LED	Yellow LED	Green LED
On solid	-	-	Connected over TCP
Fast blink	Not associated	Rx/Tx data transfer	No IP address
Slow blink	Associated, no Internet	-	IP address OK
Off	Associated, Internet OK	-	-

## HARDWARE SETUP

---

To set up the hardware, perform the following steps:

1. Mount the RN-XV module onto the socket at M1 on the RN-XV-RD2 evaluation board. The header is not keyed; you must orient the module as shown in Figure 2. The RN-XV provides power to the evaluation board.
2. Connect the USB cable to a USB port on your computer. Windows should automatically install the drivers for the cable. If it does not, download and install the FTDI drivers from the Support page on the Roving Networks website at <http://www.rovingnetworks.com/support.php>. Note the COM port to which you have attached the cable.
3. Connect the USB cable to the evaluation board at J2.
4. Attach a jumper to the pins at J1 if the board if it is missing.

**NOTE:** If you remove the jumper, you can use these pins to probe voltage levels on the board. If, however, you leave the J1 pins without a jumper, the board will not function.

The RN-XV supports several antenna options. The RN-XV-W, which Roving Networks recommends you use for this evaluation, is shipped with a wire antenna. Therefore, you do not need to install a separate antenna for the evaluation described in this document.

## CONFIGURATION

When using the standard WiFly firmware, the module operates in two modes: data mode (default) and command mode. While in data mode, the module is essentially a data pipe. When the module receives data over Wi-Fi, it strips the TCP/IP headers and trailers and passes the user data to the UART. When data is written to the UART, the module constructs the TCP/IP packet and sends it out over Wi-Fi. Thus, the entire process of sending/receiving data to the host is transparent to the end microprocessor. See Figure 2.

**Figure 2. Data & Command Modes**

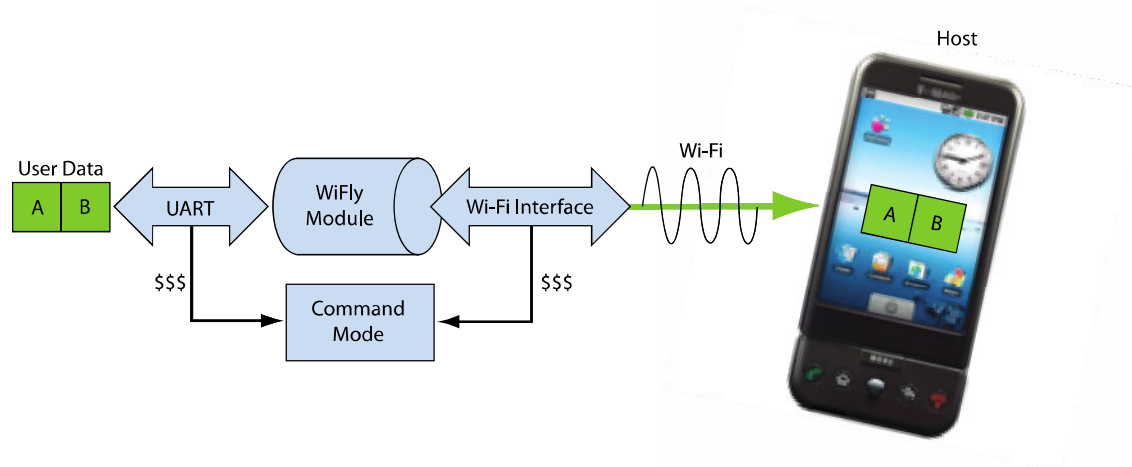

By default, the module is in data mode. Sending the escape sequence **\$\$\$** causes the module to enter command mode. Once in command mode, you can configure the WiFly device using simple ASCII commands. To exit command mode and return to data mode, type **exit <cr>**.

Basic configuration only requires the wireless network access point's name (SSID) and authentication password. The WiFly module can only associate with one network at a time. Roving Networks recommends that you begin your evaluation by configuring the WiFly module using an open access point to simplify the setup.

There are two ways to configure the WiFly module:

- Over the UART, which is connected to a computer or microprocessor
- Via Wi-Fi using ad hoc networking

You need a terminal emulator to complete the setup.

**NOTE:** Roving Networks suggests using either the TeraTerm (Windows OS) or CoolTerm (Mac OS-X) terminal emulator program.

### Configuration Using the RS-232 Serial Interface

The USB-to-serial cable allows your computer to communicate with the WiFly module on your evaluation board. The following instructions describe how to use a terminal emulator to go into configuration mode, send commands to find networks, associate with an access point, and save your configuration.

### Configure the Module Using a Terminal Emulator

To communicate with the module using a terminal emulator, perform the following steps:

1. Determine the COM port that was assigned to the USB-to-serial cable. If you do not know the COM port number, you can find it using the Windows Device Manager, which is in the system tools. In the Device Manager, browse and expand the selection for Ports (COM & LPT). In the example shown in Figure 3, the USB serial port is COM9.  
For OS-X, if you are using CoolTerm, you can view and select the port from within the application.
2. Open your terminal emulation program.
3. Specify the COM port. If you are using TeraTerm, select *Serial* and choose the COM port number from the *Port* drop-down list box.

**NOTE:** The default serial port setting for the WiFly module is 9600 baud, 8 bits, no parity, and 1 stop bit.

**Figure 3. Finding the COM Port Number in Windows**

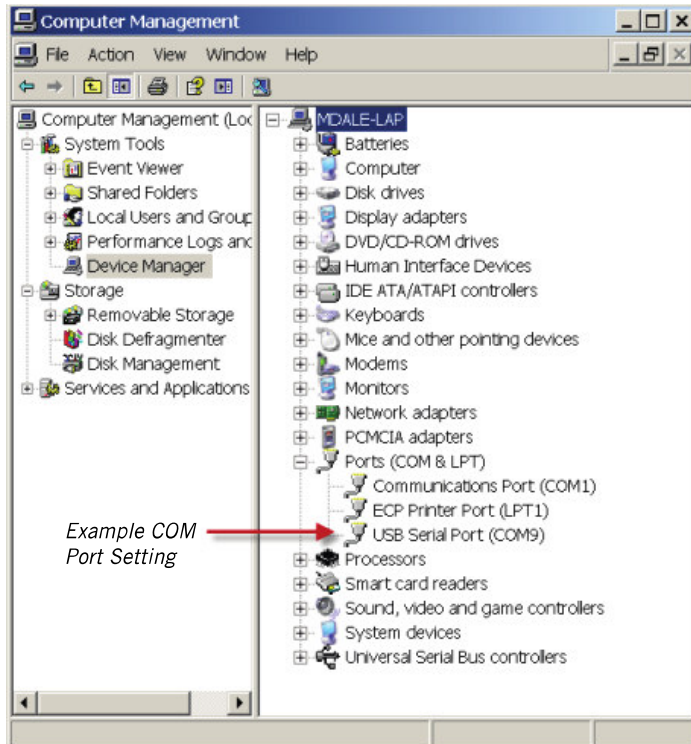

### Enter Command Mode

To enter command mode, perform the following steps in the terminal emulator:

1. Type **\$\$\$**. You must type **\$\$\$** together quickly with no additional characters before or after them. The module replies with **CMD** to indicate it is in command mode.
2. Type **show net <cr>** to display the current network settings.

**NOTE:** When a command completes, the terminal displays a prompt in the format <X.XX> where X.XX indicates the module's firmware version. In the example in Figure 4, the version is 2.28.

**Figure 4. Show Current Network Settings**

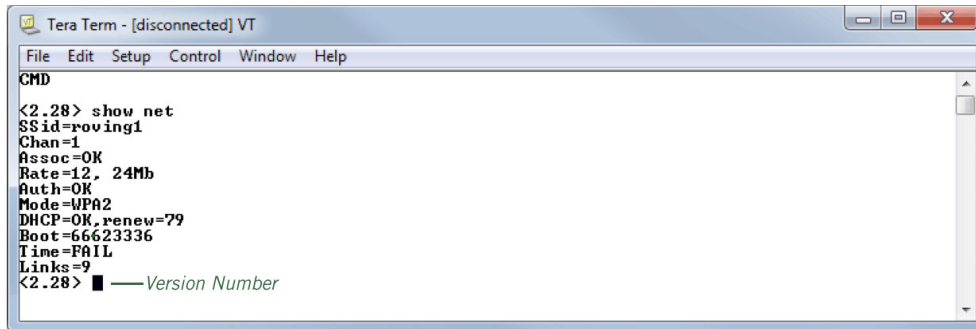

To issue commands to the module, you send a keyword followed by optional parameters. Commands are case sensitive, and you cannot use spaces in parameters. Use a \$ to indicate a space, e.g., **MY NETWORK** should be written as **MY\$NETWORK**. Additionally, you can use shorthand for the parameters. For example, the following commands are equivalent:

- **set uart baudrate 115200**
- **set uart b 115200**
- **set u b 15200**

**NOTE:** You cannot use shorthand for command keywords. For example, **s uart baudrate 115200** is an illegal combination.

The WiFly module supports a variety of command keywords. The *Advanced User Manual*, which is available on the Support page of the Roving Networks website, provides a complete command reference. For evaluation purposes, you may view the current settings using the **get** command; **get everything** (or **get e** in shorthand) shows all parameters. Table 3 shows additional parameters for the **set** and **get** commands.

**Table 3. Basic set & get Parameters**

Parameter	Function
adhoc	Controls the ad hoc parameters.
broadcast	Controls the broadcast hello/heartbeat UDP message.
comm	Communication and data transfer, matching characters.
dns	DNS host and domain.
ftp	FTP host address and login information.
ip	IP settings.
option	Optional and infrequently used parameters.
sys	System settings, such as sleep and wake timers.
time	Realtime clock settings.
uart	Serial port settings, such as baud rate and parity.

wlan	Wireless interface, such as SSID, channel, and security options.
------	--

### Find Available Networks

Once you are in command mode, you can instruct the module to search for available networks. Type **scan** <cr> in the terminal emulator to view a list of Wi-Fi networks within range. See Figure 5.

**Figure 5. Scan for Networks**

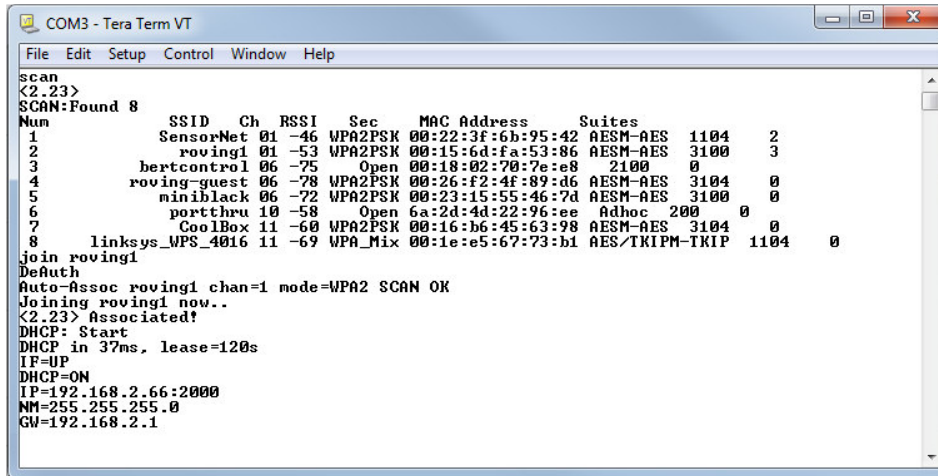

```

COM3 - Tera Term VT
File Edit Setup Control Window Help
scan
<2.23>
SCAN:Found 8
Num      SSID      Ch  RSSI  Sec  MAC Address      Suites
1        SensorNet 01 -46 WPA2PSK 00:22:3f:6b:95:42 AESM-AES 1104 2
2        roving1   01 -53 WPA2PSK 00:15:6d:fa:53:86 AESM-AES 3100 3
3        bertcontrol 06 -75 Open 00:18:02:70:7e:e8 2100 0
4        roving-guest 06 -78 WPA2PSK 00:26:f2:4f:89:d6 AESM-AES 3104 0
5        miniblack 06 -72 WPA2PSK 00:23:15:55:46:7d AESM-AES 3100 0
6        portthru  10 -58 Open 6a:2d:4d:22:96:ee Adhoc 200 0
7        CoolBox  11 -60 WPA2PSK 00:16:b6:45:63:98 AESM-AES 3104 0
8        linksys_WPS_4016 11 -69 WPA_Mix 00:1e:e5:67:73:b1 AES/TKIPM-TKIP 1104 0
join roving1
DeAuth
Auto-Assoc roving1 chan=1 mode=WPA2 SCAN OK
Joining roving1 now..
<2.23> Associated!
DHCP: Start
DHCP in 37ms, lease=120s
IF=UP
DHCP=ON
IP=192.168.2.66:2000
NM=255.255.255.0
GW=192.168.2.1
    
```

### Associate with an Access Point

You use the **join** keyword to associate with an open access point. As shown in the scan list, **roving1** is an open access point. To associate with an access point, type the following commands (refer back to Figure 5):

```
join roving1
```

or

```
join # 1 // The space must be included between # and 1
```

To disconnect from a network, type **leave** <cr>. The red LED blinks quickly when the WiFly module is not associated with an access point.

If you want the module to associate with a network automatically upon booting (i.e., persistent configuration), use the **set wlan** command with the SSID name. For example, type:

```
set wlan ssid roving1
save
reboot
```

When the module wakes or power cycles, the module attempts to associate with the network **roving1** (the default name).

To associate with a secure network you must also include the network password. The WiFly module determines the security type automatically. In this case, type:



```

set wlan ssid roving1           // roving1 is the default name
set wlan pass rubygirl         // rubygirl is the default password
save
reboot
  
```

See Figure 6. You can confirm the security settings by typing **get wlan** <cr>.

**Figure 6. Connect to a Secure Network**

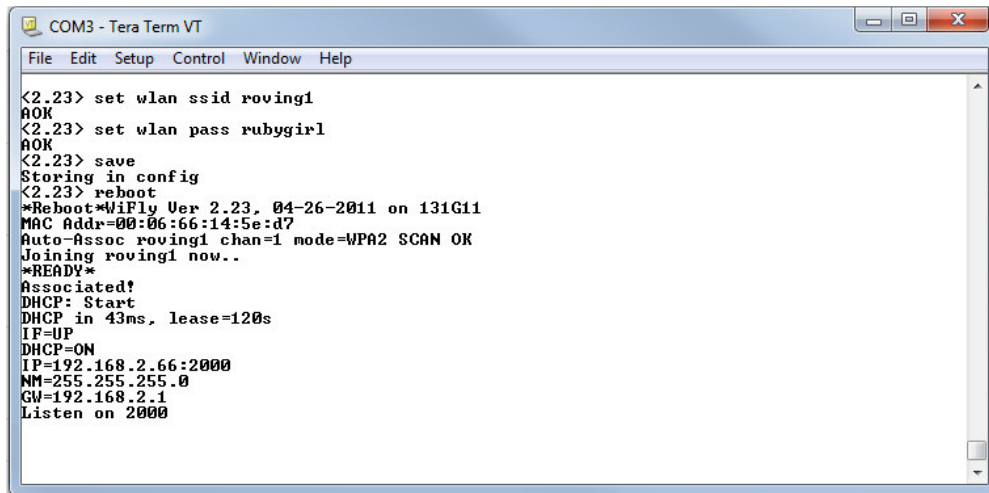

```

COM3 - Tera Term VT
File Edit Setup Control Window Help
<2.23> set wlan ssid roving1
OK
<2.23> set wlan pass rubygirl
OK
<2.23> save
Storing in config
<2.23> reboot
*Reboot*WiFly Ver: 2.23, 04-26-2011 on 131G11
MAC Addr=00:06:66:14:5e:d7
Auto-Assoc roving1 chan=1 mode=WPA2 SCAN OK
Joining roving1 now..
*READY*
Associated!
DHCP: Start
DHCP in 43ms, lease=120s
IF=UP
DHCP=ON
IP=192.168.2.66:2000
NM=255.255.255.0
GW=192.168.2.1
Listen on 2000
  
```

## Configuration Using Ad Hoc Mode

You can configure the module over the air via an ad hoc network. Ad hoc networks are useful for point-to-point communication. In ad hoc mode, the WiFly appears as an access point with which other Wi-Fi devices can associate. You can turn on ad hoc mode using hardware or software configuration.

**NOTE:** the WiFly module only supports the OPEN mode for ad hoc networks.

### Enable Ad Hoc Mode via Hardware

To enable ad hoc mode using hardware, set GPIO9 high (3.3 V) at power up. For the RN-134 board, GPIO9 is on pin 1 on the jumper block (J2). For the RN-174 board, GPIO9 is on the J6 connector. Upon power up with GPIO9 high, the module creates an ad hoc network with the following settings:

```

SSID:           WiFly-GSX-XX, where XX is the final two bytes of the device's MAC address
IP address:     169.254.1.1
  
```

### Enable Ad Hoc Mode via Software

To enable ad hoc mode in software, you use the **set wlan** command with the **join**, **ssid**, and **chan** parameters. For example, type the following commands in command mode:

```

set wlan join 4
set wlan ssid my_adhoc_network
set wlan chan 1
  
```

Set the WiFly module's IP address and netmask. Because automatic IP assignment fixes the first two bytes of the IP address, use 255.255.0.0 as the netmask so that other devices connecting to the module can be reached. You can also set the netmask to a smaller subnet if the other device's IP addresses begin statically at the same subnet as the ad hoc device.

```
set ip address 169.254.1.1
set ip netmask 255.255.0.0
```

Turn off DHCP so that the module does not attempt to obtain an IP address from another device.

```
set ip dhcp 0
```

Save your configuration and reboot. The module will be in ad hoc mode. See Figure 7.

**Figure 7. Enable Ad Hoc Network Mode**

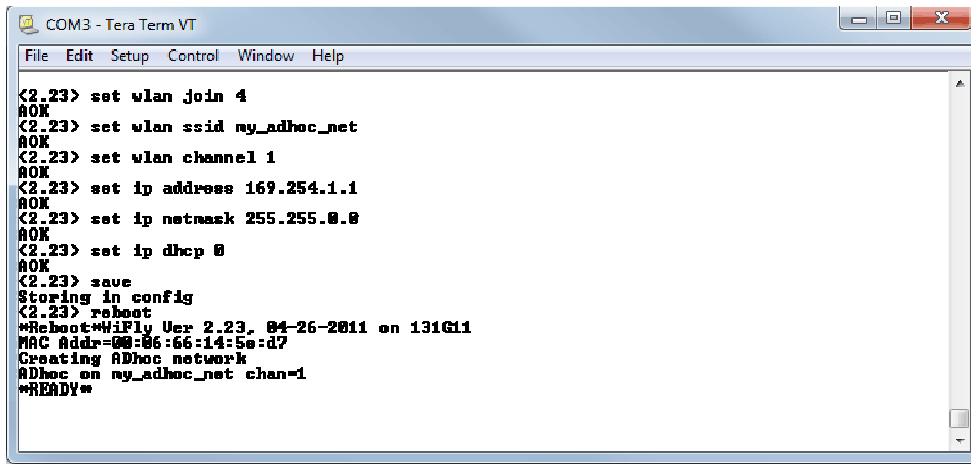

```
COM3 - Tera Term VT
File Edit Setup Control Window Help
<2.23> set wlan join 4
AOK
<2.23> set wlan ssid my_adhoc_net
AOK
<2.23> set wlan channel 1
AOK
<2.23> set ip address 169.254.1.1
AOK
<2.23> set ip netmask 255.255.0.0
AOK
<2.23> set ip dhcp 0
AOK
<2.23> save
Storing in config
<2.23> reboot
*Reboot*WiFly Ver 2.23, 04-26-2011 on 131G11
MAC Addr=00:06:66:14:5e:d7
Creating Adhoc network
Adhoc on my_adhoc_net chan=1
*READY*
```

### *Associate with an Ad Hoc Network*

The WiFly module can associate with an ad hoc network created by another device. Type the commands:

```
set wlan ssid my_adhoc_network
save
reboot
```

To associate with an ad hoc network without saving the changes to the module's flash memory, use the **join** command, e.g., **join my\_adhoc\_network <cr>**.

If DHCP is enabled, the WiFly device obtains an IP address automatically when it associates with the ad hoc network. By definition, auto IP sets the first two bytes of the subnet to 169.254.xxx.xxx. The WiFly device requires 2 to 3 seconds to resolve the IP address.

To set the IP address statically, disable DHCP and explicitly assign the IP address:

```
set ip dhcp 0
set ip address 169.254.1.2
```

You can confirm that the device has properly associated with the ad hoc network using the **ping** keyword:

```
ping 169.254.1.1 10
```

### *Associate with the Module over an Ad Hoc Network from a Computer*

You can associate with the ad hoc network from a computer by specifying the network name (and password, if required) in the operating system. For example, choose Control Panel > Networking and Sharing > Networking and Sharing Center (Windows Vista) or Control Panel > Network Connections (Windows XP). You can then view available networks and select the name of the WiFly ad hoc network.

**NOTE:** Once associated with the ad hoc network, Windows Vista may require a few minutes to allocate an IP address. To work around this issue, assign a static IP address under Network Settings > TCP/IP > Properties.

Once your computer is associated with the ad hoc network, you can use the WiFly module's IP address to open a connection or connect using telnet as you would with an enterprise connection.

**NOTE:** The WiFly module does not support ad hoc and infrastructure network modes simultaneously.

Once you have associated with the other network, you can telnet into the WiFly module to configure it. Open the telnet connection using port 2000.

## EXAMPLES

---

The following examples control the relay functionality. Two GPIO pins on the RN-XV module control the relays. You turn the relays on/off by driving the pins high/low using software commands. You can use these relays for a variety of wireless applications, such as controlling equipment (light bulbs, fans, etc.).

Example: Relay 1

```
set system mask 0x21f2 I           // Turn the relay on
set system output 0x0002
```

```
set system mask 0x21f2 I           // Turn the relay off
set system output 0
```

Example: Relay 2

```
set system mask 0x21f2 I           // Turn the relay on
set system output 0x0100
```

```
set system mask 0x21f2 I           // Turn the relay off
set system output 0
```

## RESOURCES & RELATED DOCUMENTS

---

For more information, refer to the following sources, which are available on the Support page on the Roving Networks website at <http://www.rovingnetworks.com/support.php>:

- *RN-XV Data Sheet*
- *RN-171 Data Sheet*
- *WiFly Advanced User Manual*
- *WiFly Training Presentation*
- Drivers, tools, and utilities

## ORDERING INFORMATION

---

Table 4 provides ordering information. For the evaluation described in this document, Roving Networks recommends purchasing the RN-XV-W, which has a ¼ inch wire antenna.

*Table 4. Ordering Information*

<b>Part Number</b>	<b>Description</b>
RN-XV-RD2	Evaluation board.
RN-171XVW-I/RM	Standard configuration, industrial temperature, Wi-Fi, 802.15.4 replacement solution with ¼ inch wire antenna. For other configurations, contact Roving Networks directly.
RN-171XVS-I/RM	Custom configuration, industrial temperature (-40 °C to +85 °C) Wi-Fi, 802.15.4 replacement solution with SMA connector.
RN-171XVU-I/RM	Custom configuration, industrial temperature (-40 °C to +85 °C) Wi-Fi, 802.15.4 replacement solution with U.FL. connector.
RN-USB-SERIAL	USB cable.

Go to <http://www.rovingnetworks.com> for current pricing and a list of distributors carrying Roving Networks products.

## NOTES

Roving Networks, Inc.  
102 Cooper Court  
Los Gatos, CA 95032  
+1 (408) 395-5300  
[www.rovingnetworks.com](http://www.rovingnetworks.com)

Copyright © 2012 Roving Networks. All rights reserved. Roving Networks is a registered trademark of Roving Networks. Apple Inc., iPhone, iPad, iTunes, Made for iPhone are registered trademarks of Apple Computer.

Roving Networks reserves the right to make corrections, modifications, and other changes to its products, documentation and services at any time. Customers should obtain the latest relevant information before placing orders and should verify that such information is current and complete.

Roving Networks assumes no liability for applications assistance or customer's product design. Customers are responsible for their products and applications which use Roving Networks components. To minimize customer product risks, customers should provide adequate design and operating safeguards.

Roving Networks products are not authorized for use in safety-critical applications (such as life support) where a failure of the Roving Networks product would reasonably be expected to cause severe personal injury or death, unless officers of the parties have executed an agreement specifically governing such use.



## Стандарт Электрон Связь

Мы молодая и активно развивающаяся компания в области поставок электронных компонентов. Мы поставляем электронные компоненты отечественного и импортного производства напрямую от производителей и с крупнейших складов мира.

Благодаря сотрудничеству с мировыми поставщиками мы осуществляем комплексные и плановые поставки широчайшего спектра электронных компонентов.

Собственная эффективная логистика и склад в обеспечивает надежную поставку продукции в точно указанные сроки по всей России.

Мы осуществляем техническую поддержку нашим клиентам и предпродажную проверку качества продукции. На все поставляемые продукты мы предоставляем гарантию .

Осуществляем поставки продукции под контролем ВП МО РФ на предприятия военно-промышленного комплекса России , а также работаем в рамках 275 ФЗ с открытием отдельных счетов в уполномоченном банке. Система менеджмента качества компании соответствует требованиям ГОСТ ISO 9001.

Минимальные сроки поставки, гибкие цены, неограниченный ассортимент и индивидуальный подход к клиентам являются основой для выстраивания долгосрочного и эффективного сотрудничества с предприятиями радиоэлектронной промышленности, предприятиями ВПК и научно-исследовательскими институтами России.

С нами вы становитесь еще успешнее!

### Наши контакты:

**Телефон:** +7 812 627 14 35

**Электронная почта:** [sales@st-electron.ru](mailto:sales@st-electron.ru)

**Адрес:** 198099, Санкт-Петербург,  
Промышленная ул, дом № 19, литера Н,  
помещение 100-Н Офис 331