



GPIO Expander Keypad and LCD Demo Board User's Guide

Note the following details of the code protection feature on Microchip devices:

- Microchip products meet the specification contained in their particular Microchip Data Sheet.
- Microchip believes that its family of products is one of the most secure families of its kind on the market today, when used in the intended manner and under normal conditions.
- There are dishonest and possibly illegal methods used to breach the code protection feature. All of these methods, to our knowledge, require using the Microchip products in a manner outside the operating specifications contained in Microchip's Data Sheets. Most likely, the person doing so is engaged in theft of intellectual property.
- Microchip is willing to work with the customer who is concerned about the integrity of their code.
- Neither Microchip nor any other semiconductor manufacturer can guarantee the security of their code. Code protection does not mean that we are guaranteeing the product as "unbreakable."

Code protection is constantly evolving. We at Microchip are committed to continuously improving the code protection features of our products. Attempts to break Microchip's code protection feature may be a violation of the Digital Millennium Copyright Act. If such acts allow unauthorized access to your software or other copyrighted work, you may have a right to sue for relief under that Act.

Information contained in this publication regarding device applications and the like is provided only for your convenience and may be superseded by updates. It is your responsibility to ensure that your application meets with your specifications. MICROCHIP MAKES NO REPRESENTATIONS OR WARRANTIES OF ANY KIND WHETHER EXPRESS OR IMPLIED, WRITTEN OR ORAL, STATUTORY OR OTHERWISE, RELATED TO THE INFORMATION, INCLUDING BUT NOT LIMITED TO ITS CONDITION, QUALITY, PERFORMANCE, MERCHANTABILITY OR FITNESS FOR PURPOSE. Microchip disclaims all liability arising from this information and its use. Use of Microchip devices in life support and/or safety applications is entirely at the buyer's risk, and the buyer agrees to defend, indemnify and hold harmless Microchip from any and all damages, claims, suits, or expenses resulting from such use. No licenses are conveyed, implicitly or otherwise, under any Microchip intellectual property rights.

Trademarks

The Microchip name and logo, the Microchip logo, Accuron, dsPIC, KEELOQ, microID, MPLAB, PIC, PICmicro, PICSTART, PRO MATE, PowerSmart, rfPIC and SmartShunt are registered trademarks of Microchip Technology Incorporated in the U.S.A. and other countries.

AmPLab, FilterLab, Migratable Memory, MXDEV, MXLAB, SEEVAL, SmartSensor and The Embedded Control Solutions Company are registered trademarks of Microchip Technology Incorporated in the U.S.A.

Analog-for-the-Digital Age, Application Maestro, CodeGuard, dsPICDEM, dsPICDEM.net, dsPICworks, ECAN, ECONOMONITOR, FanSense, FlexROM, fuzzyLAB, In-Circuit Serial Programming, ICSP, ICEPIC, Linear Active Thermistor, Mindi, MiWi, MPASM, MPLIB, MPLINK, PICKIT, PICDEM, PICDEM.net, PICLAB, PICtail, PowerCal, PowerInfo, PowerMate, PowerTool, REAL ICE, rLAB, rfPICDEM, Select Mode, Smart Serial, SmartTel, Total Endurance, UNI/O, WiperLock and ZENA are trademarks of Microchip Technology Incorporated in the U.S.A. and other countries.

SQTP is a service mark of Microchip Technology Incorporated in the U.S.A.

All other trademarks mentioned herein are property of their respective companies.

© 2006, Microchip Technology Incorporated, Printed in the U.S.A., All Rights Reserved.

 Printed on recycled paper.

QUALITY MANAGEMENT SYSTEM
CERTIFIED BY DNV
== ISO/TS 16949:2002 ==

Microchip received ISO/TS-16949:2002 certification for its worldwide headquarters, design and wafer fabrication facilities in Chandler and Tempe, Arizona, Gresham, Oregon and Mountain View, California. The Company's quality system processes and procedures are for its PIC® 8-bit MCUs, KEELOQ® code hopping devices, Serial EEPROMs, microperipherals, nonvolatile memory and analog products. In addition, Microchip's quality system for the design and manufacture of development systems is ISO 9001:2000 certified.



GPIO EXPANDER KEYPAD AND LCD DEMO BOARD USER'S GUIDE

Table of Contents

Preface	1
Introduction.....	1
Document Layout	1
Conventions Used in this Guide	2
Recommended Reading.....	2
The Microchip Web Site	3
Customer Support	3
Document Revision History	3
Chapter 1. Product Overview	5
1.1 Introduction	5
1.2 What is the GPIO Expander Keypad and LCD Demo Board?	5
1.3 What The GPIO Expander Keypad and LCD Demo Board Kit Includes	5
Chapter 2. Installation and Operation	7
2.1 Introduction	7
2.2 Features	7
2.3 Getting Started	8
2.4 GPIO Expander Keypad and LCD Demo Board Description	9
2.5 Firmware Description	10
Appendix A. Schematics and Board Layouts	15
A.1 Introduction	15
A.2 Board Schematic - Page 1	16
A.3 Board Schematic - Page 2	17
A.4 Board Schematic - Page 3	18
A.5 Board - Top Layer (with Silk screen)	19
A.6 Board - Bottom Layer	19
Appendix B. Bill Of Materials (BOM)	21
Worldwide Sales and Service	24

NOTES:



GPIO EXPANDER KEYPAD AND LCD DEMO BOARD USER'S GUIDE

Preface

NOTICE TO CUSTOMERS

All documentation becomes dated, and this manual is no exception. Microchip tools and documentation are constantly evolving to meet customer needs, so some actual dialogs and/or tool descriptions may differ from those in this document. Please refer to our web site (www.microchip.com) to obtain the latest documentation available.

Documents are identified with a “DS” number. This number is located on the bottom of each page, in front of the page number. The numbering convention for the DS number is “DSXXXXA”, where “XXXX” is the document number and “A” is the revision level of the document.

INTRODUCTION

This chapter contains general information that will be useful to know before using the GPIO Expander Keypad and LCD Demo Board. Items discussed in this chapter include:

- Document Layout
- Conventions Used in this Guide
- Recommended Reading
- The Microchip Web Site
- Customer Support
- Document Revision History

DOCUMENT LAYOUT

This document describes how to use the GPIO Expander Keypad and LCD Demo Board as a development tool. The manual layout is as follows:

- **Chapter 1. “Product Overview”** – Important information about the GPIO Expander Keypad and LCD Demo Board.
- **Chapter 2. “Installation and Operation”** – Includes instructions on how to get started with this evaluation board.
- **Appendix A. “Schematics and Board Layouts”** – Shows the schematic and layout diagrams for the GPIO Expander Keypad and LCD Demo Board.
- **Appendix B. “Bill Of Materials (BOM)”** – Lists the parts used to build the GPIO Expander Keypad and LCD Demo Board.

CONVENTIONS USED IN THIS GUIDE

This manual uses the following documentation conventions:

DOCUMENTATION CONVENTIONS

Description	Represents	Examples
Arial font:		
Italic characters	Referenced books	<i>MPLAB[®] IDE User's Guide</i>
	Emphasized text	...is the <i>only</i> compiler...
Initial caps	A window	the Output window
	A dialog	the Settings dialog
	A menu selection	select Enable Programmer
Quotes	A field name in a window or dialog	"Save project before build"
Underlined, italic text with right angle bracket	A menu path	<u><i>File>Save</i></u>
Bold characters	A dialog button	Click OK
	A tab	Click the Power tab
N'Rnnnn	A number in verilog format, where N is the total number of digits, R is the radix and n is a digit.	4'b0010, 2'hF1
Text in angle brackets < >	A key on the keyboard	Press <Enter>, <F1>
Courier New font:		
Plain Courier New	Sample source code	#define START
	Filenames	autoexec.bat
	File paths	c:\mcc18\h
	Keywords	_asm, _endasm, static
	Command-line options	-Opa+, -Opa-
	Bit values	0, 1
	Constants	0xFF, 'A'
Italic Courier New	A variable argument	<i>file.o</i> , where <i>file</i> can be any valid filename
Square brackets []	Optional arguments	mcc18 [options] <i>file</i> [options]
Curly brackets and pipe character: { }	Choice of mutually exclusive arguments; an OR selection	errorlevel {0 1}

RECOMMENDED READING

For more information regarding the Stand-Alone CAN controller, CAN I/O Expander, and CAN transceiver devices, refer to the appropriate data sheet. Table 1 shows the device and associated Data Sheet literature number. These documents can be found at Microchip's web site at: www.microchip.com.

TABLE 1: DEVICES AND DATA SHEET LITERATURE NUMBERS

Device	Literature #	Device	Literature #
MCP23X08	DS21919	PIC18F4550	DS39632
MCP23X17	DS21952	MCP1702	DS22008

THE MICROCHIP WEB SITE

Microchip provides online support via our web site at www.microchip.com. This web site is used as a means to make files and information easily available to customers. Accessible by using your favorite Internet browser, the web site contains the following information:

- **Product Support** – Data sheets and errata, application notes and sample programs, design resources, user's guides and hardware support documents, latest software releases and archived software
- **General Technical Support** – Frequently Asked Questions (FAQs), technical support requests, online discussion groups, Microchip consultant program member listing
- **Business of Microchip** – Product selector and ordering guides, latest Microchip press releases, listing of seminars and events, listings of Microchip sales offices, distributors and factory representatives

CUSTOMER SUPPORT

Users of Microchip products can receive assistance through several channels:

- Distributor or Representative
- Local Sales Office
- Field Application Engineer (FAE)
- Technical Support
- Development Systems Information Line

Customers should contact their distributor, representative or field application engineer for support. Local sales offices are also available to help customers. A listing of sales offices and locations is included in the back of this document.

Technical support is available through the web site at: <http://support.microchip.com>

DOCUMENT REVISION HISTORY

Revision A (October 2006)

- Initial Release of this Document.

NOTES:

Chapter 1. Product Overview

1.1 INTRODUCTION

This chapter provides an overview of the GPIO Expander Keypad and LCD Demo Board and covers the following topics:

- What is the GPIO Expander Keypad and LCD Demo Board?
- What the GPIO Expander Keypad and LCD Demo Board Kit includes

1.2 WHAT IS THE GPIO EXPANDER KEYPAD AND LCD DEMO BOARD?

The GPIO Expander Keypad and LCD Demo Board allows the system designer to evaluate the operation of the MCP23X17 and MCP23X08 General Purpose I/O (GPIO) Expanders. The board demonstrates the GPIO Expanders' performance in a keypad and LCD example.

1.3 WHAT THE GPIO EXPANDER KEYPAD AND LCD DEMO BOARD KIT INCLUDES

This GPIO Expander Keypad and LCD Demo Board Kit includes:

- One GPIO Expander Keypad and LCD Demo Board (102-00116)
 - MCP23008 GPIO Expander with I²C™ interface (installed)
 - MCP23S08 GPIO Expander with SPI interface (installed)
 - MCP23017 GPIO Expander with I²C™ interface (installed)
 - MCP23S17 GPIO Expander with SPI interface (installed)
- Analog and Interface Products Demonstration Boards CD-ROM (DS21912)
 - GPIO Expander Keypad and LCD Demo Board User's Guide (DS51636)
 - PIC® Microcontroller Firmware
 - PCB Gerber Files

NOTES:

Chapter 2. Installation and Operation

2.1 INTRODUCTION

This chapter discusses the setup and operation of the GPIO Expander Keypad and LCD Demo Board.

The GPIO Expander Keypad and LCD Demo Board is designed to demonstrate using GPIO expanders in a keypad and LCD example. The MCP23X17 interfaces to a 2x16 LCD module and the MCP23X08 interfaces to a 4x4 keyed matrix.

Both the I²C™ and SPI versions are included on the board to demonstrate both serial interfaces.

2.2 FEATURES

The GPIO Expander Keypad and LCD Demo Board has the following features:

- Two (2) 8-bit GPIO Expanders
 - MCP23008 with I²C™ interface
 - MCP23S08 with SPI interface
- Two (2) 16-bit GPIO Expanders
 - MCP23017 with I²C™ interface
 - MCP23S17 with SPI interface
- 4X4 keypad layout (16 momentary buttons)
 - Numbers 0 - 9
 - Six special function buttons
- A 2X16 LCD module
- Headers for the MCP23X08 and MCP23X17 pins
- Header for programming the PIC18F4550

2.3 GETTING STARTED

The GPIO Expander Keypad and LCD Demo Board is a fully functional, assembled and tested board for demonstrating the MCP23008 and MCP23017 (I²C interface) and MCP23S08 and MCP23S17 (SPI interface) general purpose I/O expanders. The following describes the basic setup and operation (see [Figure 2-1](#)):

1. Either connect a 9V power supply into the power jack (J2) or connect a 5 V power supply to the V_{DD} and GND test points.
2. The green power LED will illuminate.
3. The LCD will display the startup splash screen.
4. The appropriate LEDs (I²C or SPI) will illuminate to indicate the current serial mode.
5. Pressing buttons:
 - **0 - 9, #, ***: will be reflected on the LCD
 - **M**: switches modes (I²C and SPI) to communicate with the MCP23X17 and MCP23X08; **B**: backspace; **R**: carriage return, and screen clear (2nd press); **S**: space

FIGURE 2-1: BOARD LAYOUT

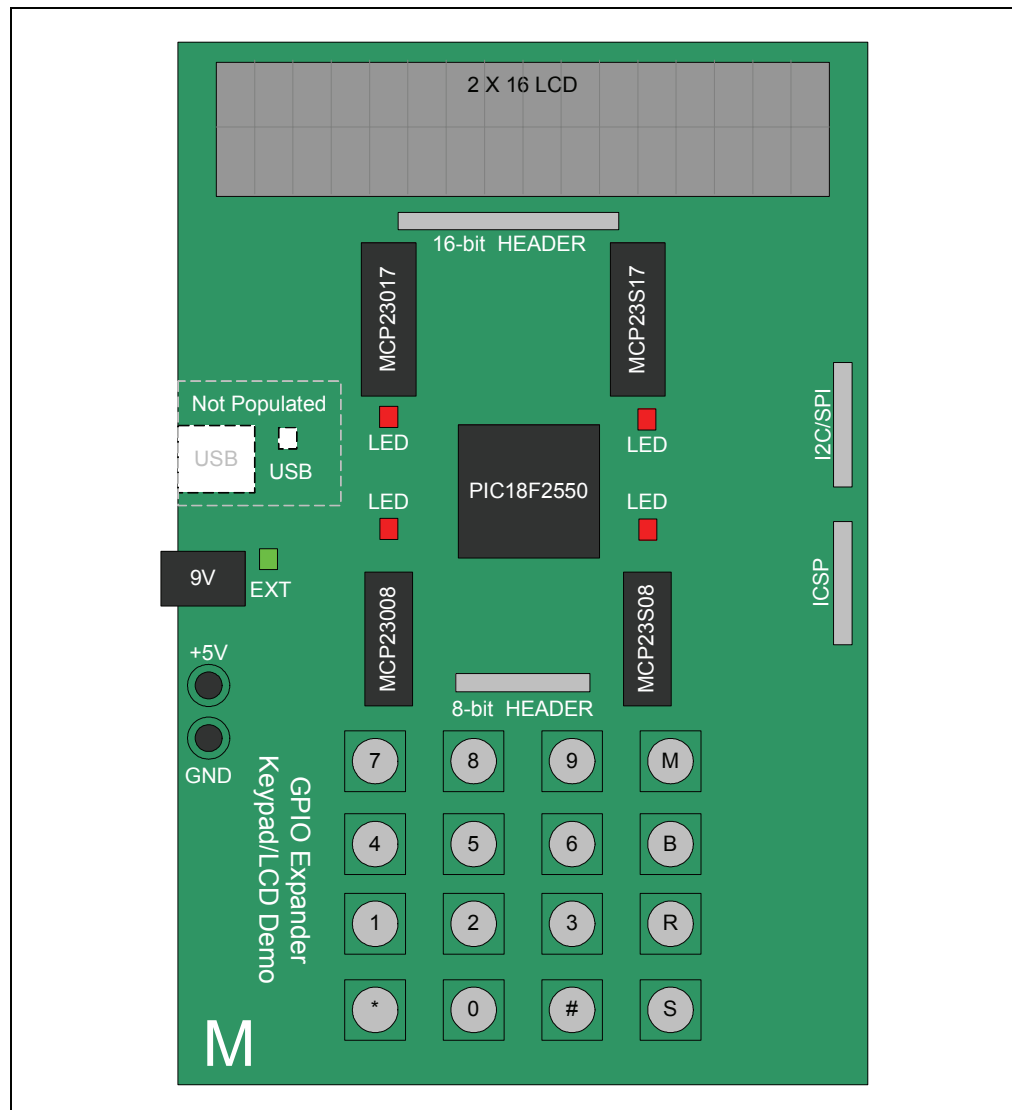

2.4 GPIO EXPANDER KEYPAD AND LCD DEMO BOARD DESCRIPTION

2.4.1 Major Board Components

The functional block diagram is shown in [Figure 2-2](#).

FIGURE 2-2: FUNCTIONAL BLOCK DIAGRAM

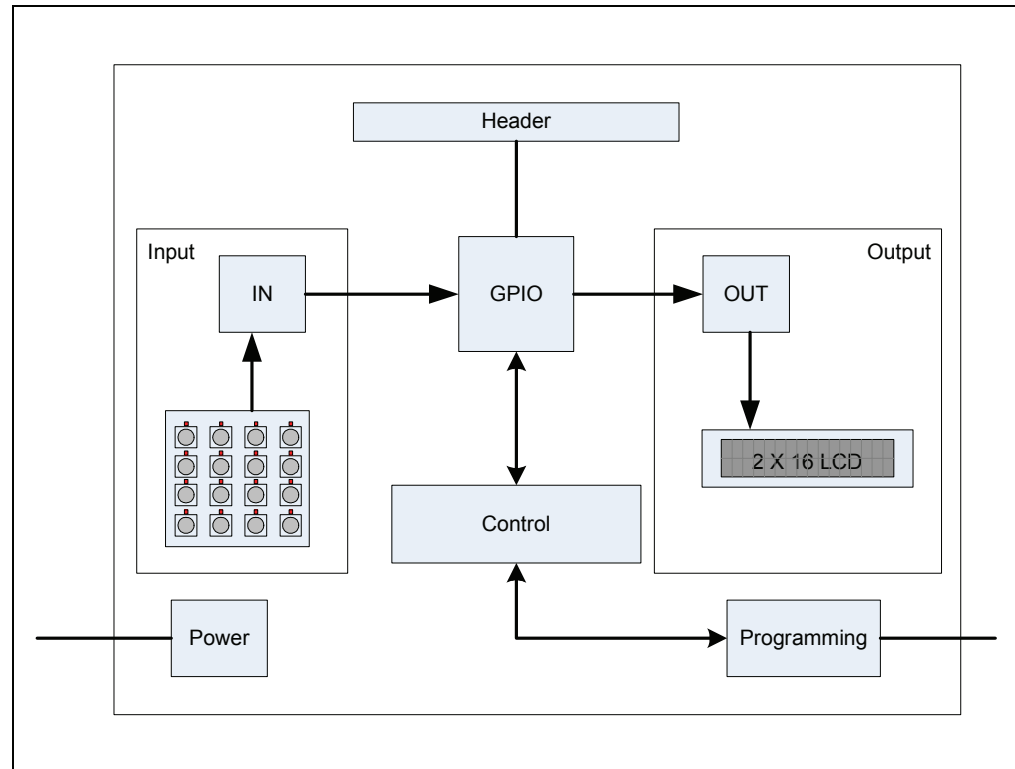

1. The **GPIO BLOCK** contains the MCP23X17 and MCP23X08 GPIO Expanders. Two (2) MCP23X17 devices are connected to the LCD module and two (2) MCP23X08 devices are connected to the keypad matrix. A button on the keypad toggles between I²C and SPI mode. When in **I²C mode**, the MCP23017 and MCP23008 are controlled by the PIC MCU. When in **SPI mode**, the MCP23S17 and MCP23S08 are controlled. Only one (1) MCP23X08 and one (1) MCP23X17 is on the bus at a time.
2. The **CONTROL BLOCK** contains the PIC18F4550 and is the main intelligence in the system.
3. The **INPUT BLOCK** contains the 4x4 keypad matrix. The MCP23X08 devices are used to scan the keys.
4. The **OUTPUT BLOCK** contains the 2x16 LCD. The MCP23X17 devices control the display.
5. The MCP23X17 and MCP23X08 I/O and serial lines are routed to the **HEADER BLOCK** to allow the pins to be probed.
6. The **PROGRAMMING BLOCK** contains the ICSP™ header for programming/debugging the PIC18F4550.
7. The **POWER BLOCK** contains the MCP1702 5V voltage regulator. The board can be powered by a 9V supply (connected through the power jack) or by applying 5V directly to the power points.

2.5 FIRMWARE DESCRIPTION

See [Figure 2-3](#) for the main firmware flow diagram.

Main Function:

1. The firmware first configures the PIC MCU.
2. The MCP23X08 and MCP23X17 devices are configured. I²C Devices are selected first by default. The SPI devices I/O are held in reset.
3. The LCD splash screen is shown.
4. Wait for an interrupt from the MCP23X08. An interrupt will occur when a button is pressed. Four (4) inputs are configured to interrupt on falling edge. These inputs are for the "columns" of the keypad matrix.
5. After the interrupt occurs, the firmware calls the **Scan_Buttons** routine.
6. Then the **Update_LCD** routine.

Scan_Buttons Function:

1. Read INTCAP register. This register contains a snapshot of the port condition when the interrupt occurred.
2. Swap inputs and outputs so the rows can be read.
3. Read GPIO register and merge with variable containing INTCAP value.
4. The pressed key is determined by looking up the result in a lookup table.

Update_LCD Function:

1. The LCD is updated based on which button was pressed.

FIGURE 2-3: MAIN FIRMWARE FLOW

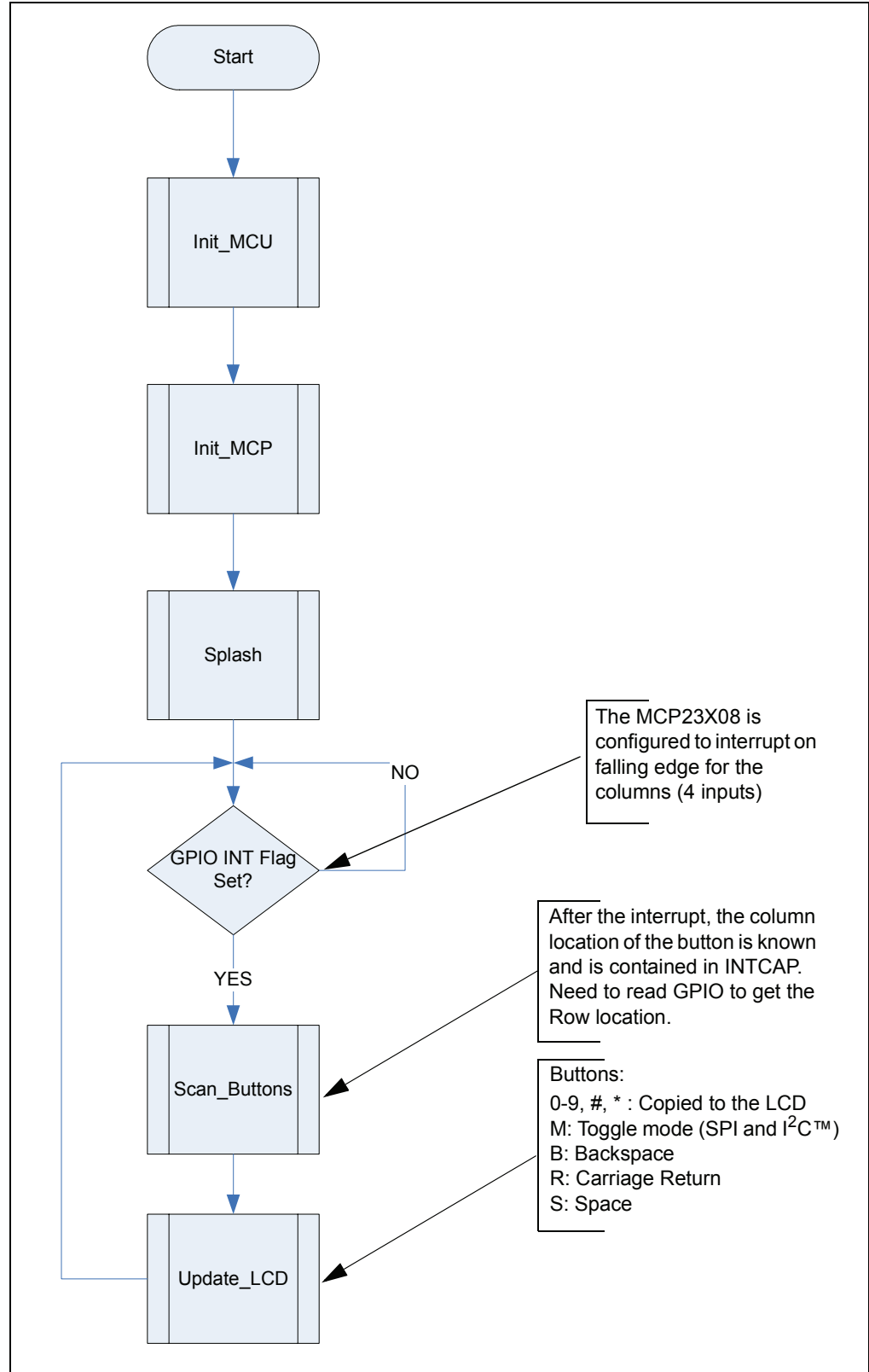

FIGURE 2-4: KEYPAD SCAN

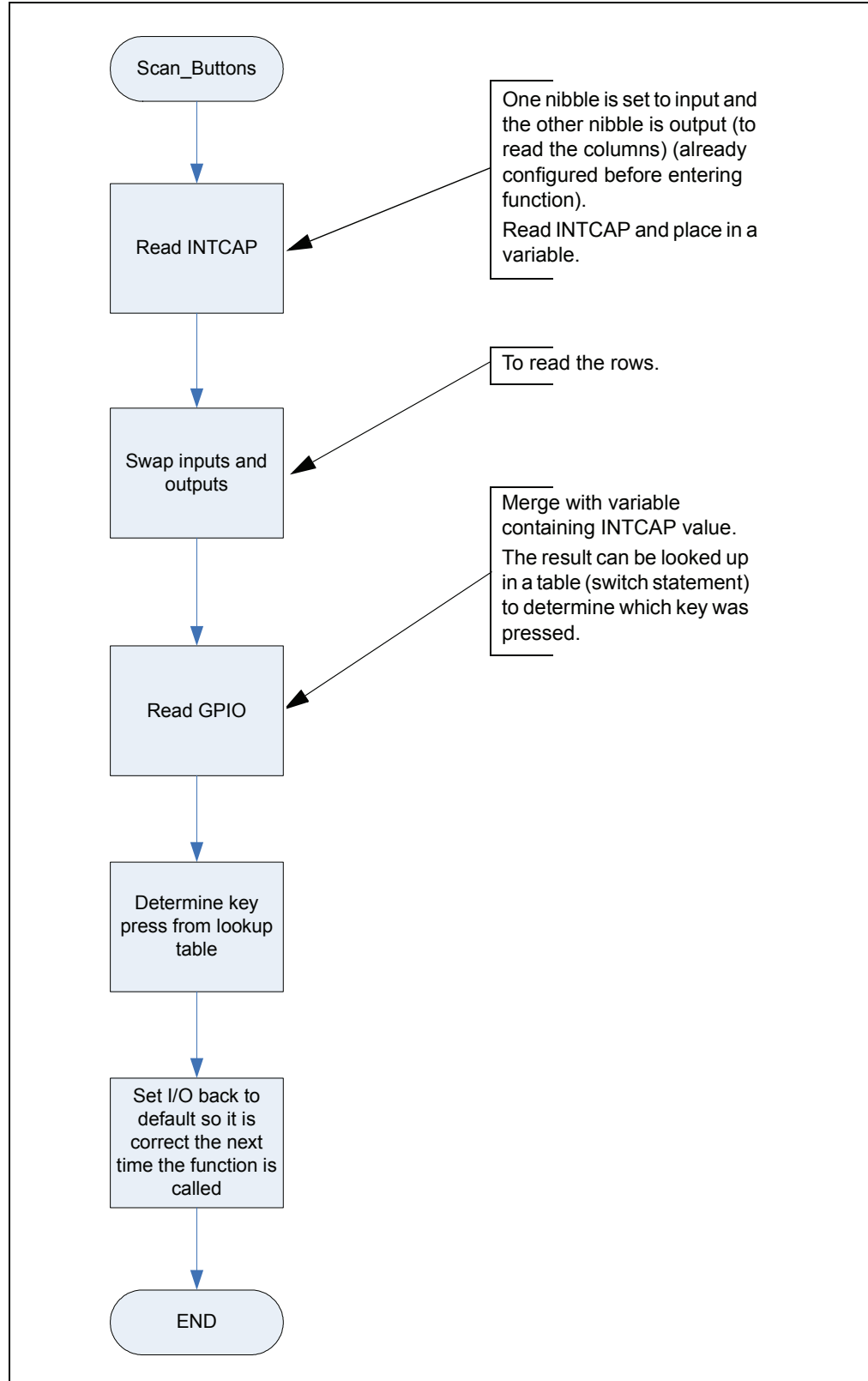
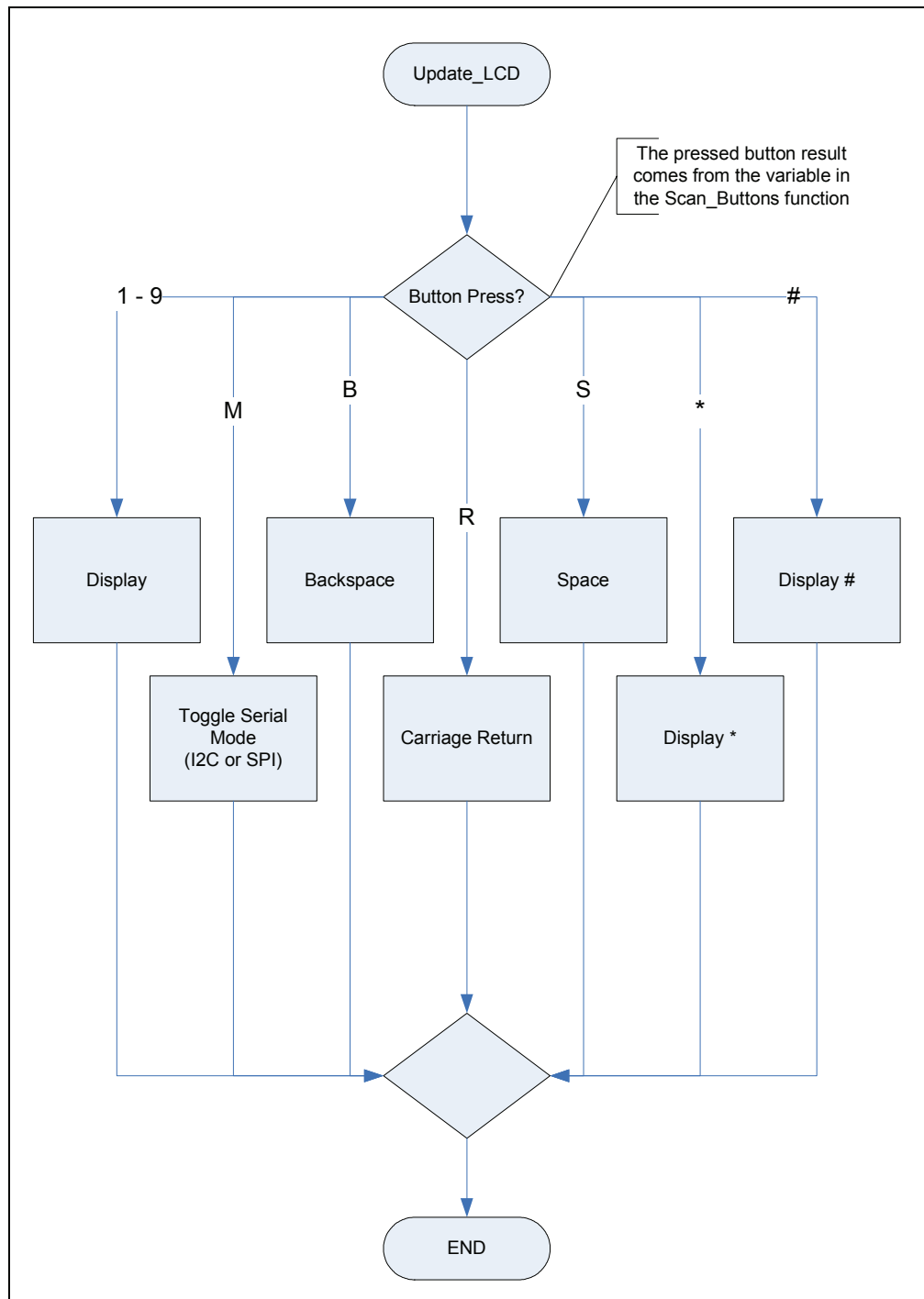

FIGURE 2-5: LCD UPDATE



NOTES:



GPIO EXPANDER KEYPAD AND LCD DEMO BOARD USER'S GUIDE

Appendix A. Schematics and Board Layouts

A.1 INTRODUCTION

This appendix contains the schematic and PCB layout for the GPIO Expander Keypad and LCD Demo Board. Diagrams included:

- Board Schematics - Pages 1 - 3.
- Board - Top Layer (with silk screen)
- Board - Bottom Layer

Schematics and Board Layouts

A.3 BOARD SCHEMATIC - PAGE 2

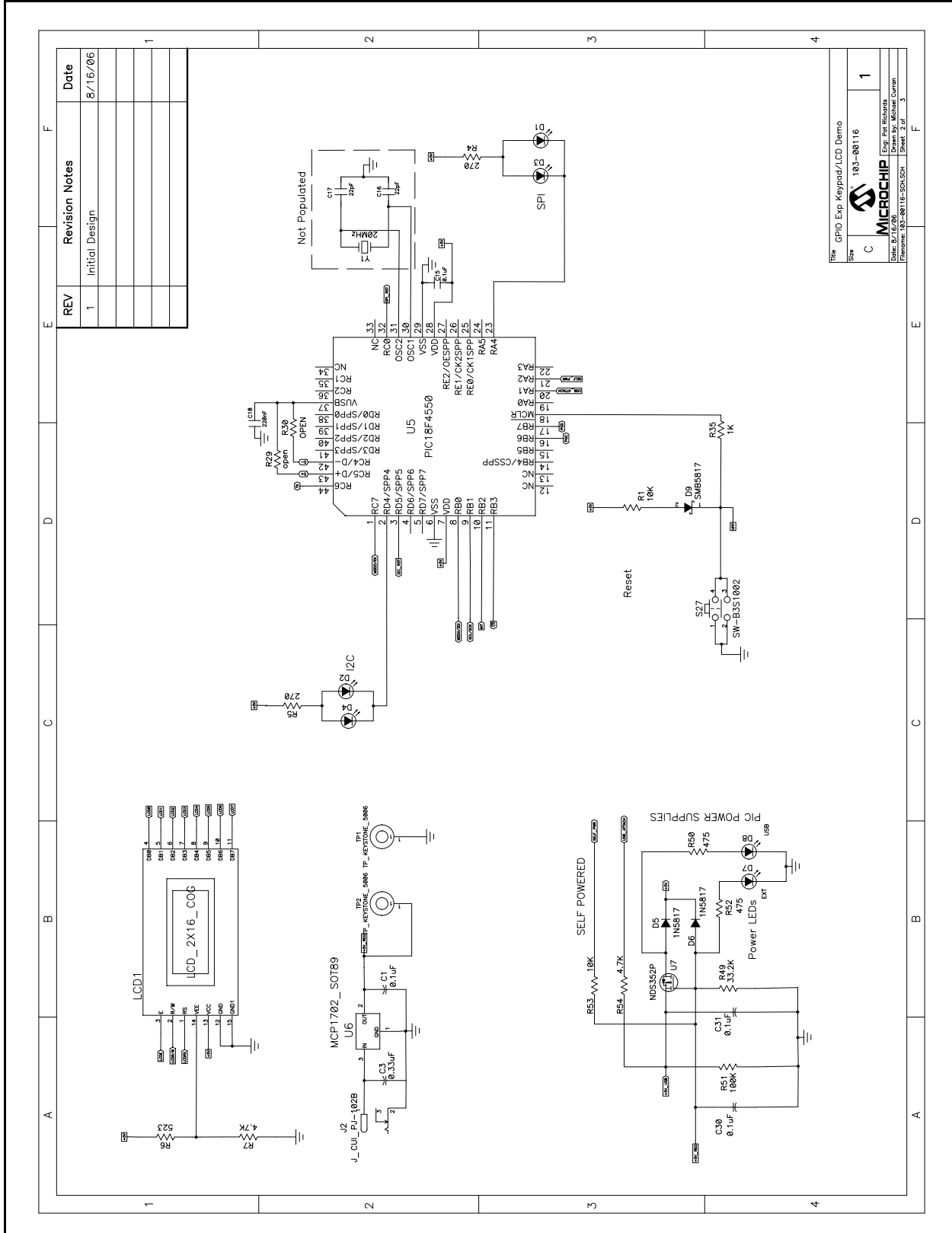

A.4 BOARD SCHEMATIC - PAGE 3

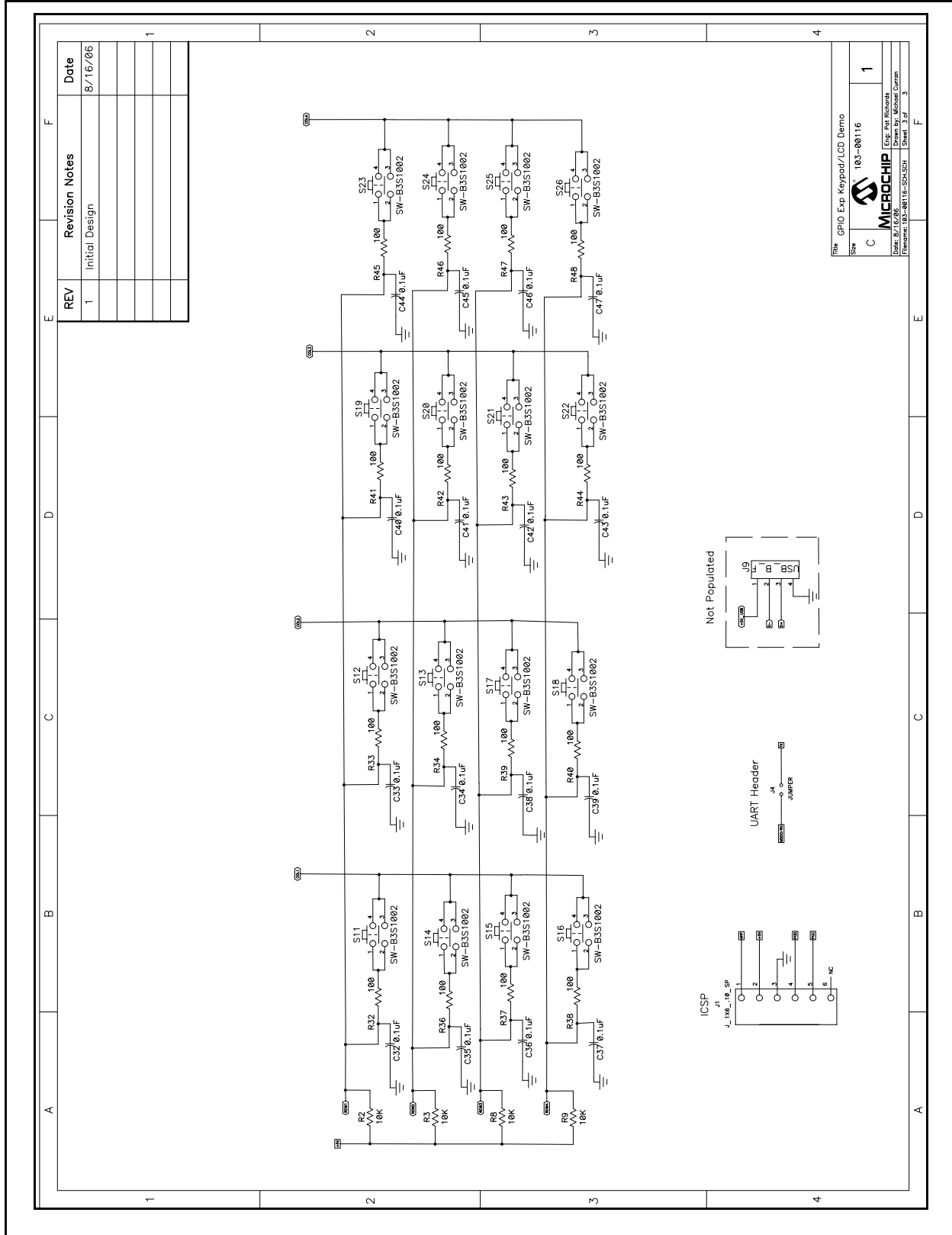

File: GPIO Exp. Keypad/LCD Demo
 Size: 103-00116
 C
MICROCHIP
 Eric F. Richards
 Date: 8/16/06
 Drawn By: Michael Curran
 Filename: 103-00116-001.SCH | Sheet: 3 of 3

A.5 BOARD - TOP LAYER (WITH SILK SCREEN)

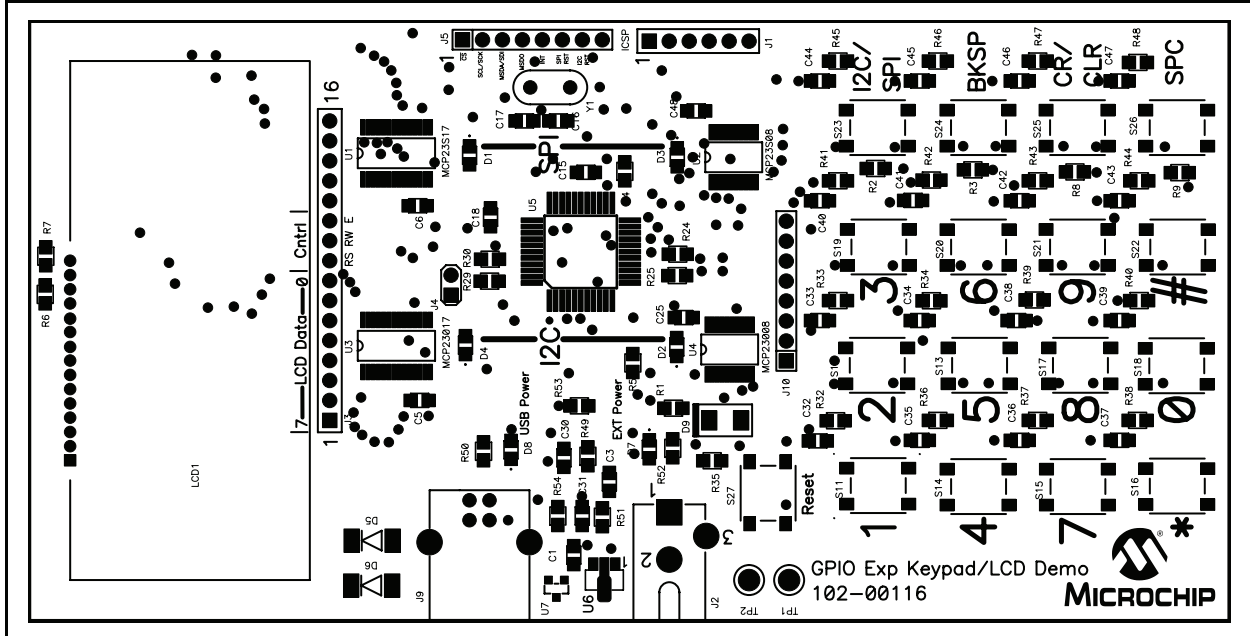

A.6 BOARD - BOTTOM LAYER

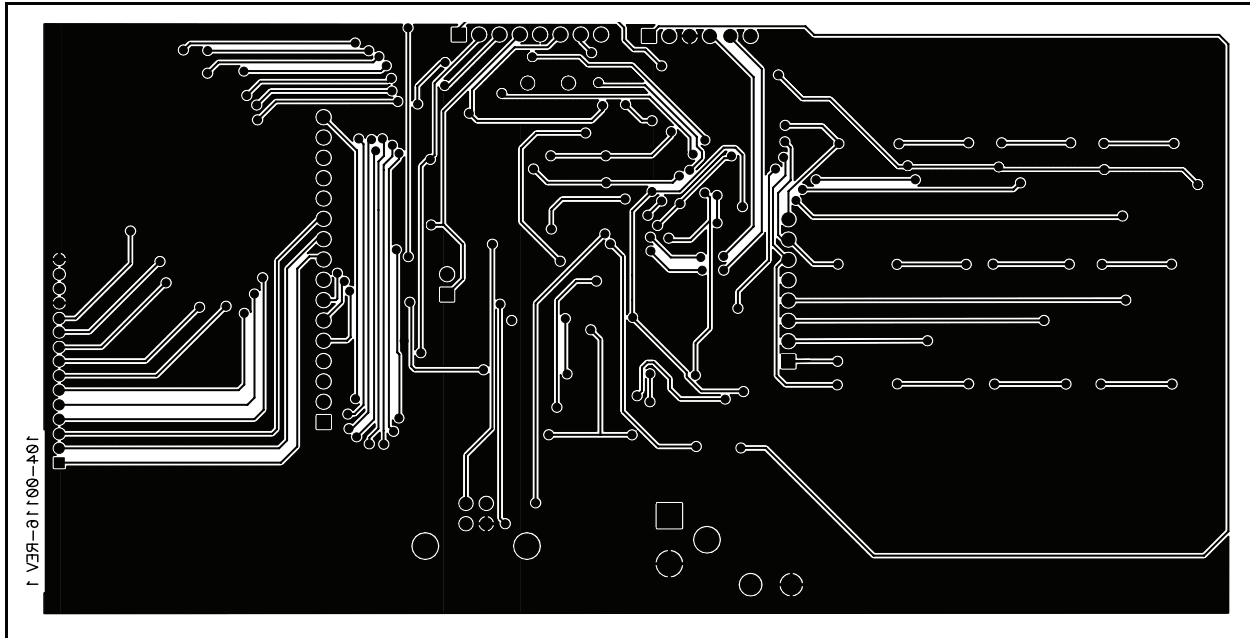

NOTES:



GPIO EXPANDER KEYPAD AND LCD DEMO BOARD USER'S GUIDE

Appendix B. Bill Of Materials (BOM)

TABLE B-1: BILL OF MATERIALS

Qty	Reference Designator	Description	Manufacturer	Part Number
23	C1, C5, C6 C15, C25, C30, C31, C32, C33, C34, C35, C36, C37, C38, C39, C40, C41, C42, C43, C44, C45, C46, C47, C48	CAP 1UF 16V CERAMIC Y5V 0805	Panasonic® - ECG	ECJ-2VF1C105Z
1	C3	CAP CER .33UF 16V Y5V 0805	Murata Electronics® North America	GRM219F51C334ZA01D
2	C16, C17	CAP 22PF 50V CERM CHIP 0805 SMD *Do Not Populate*	Panasonic - ECG	ECJ-2VC1H220J
1	C18	CAP .22UF 16V CERAMIC X7R 0805	Panasonic - ECG	ECJ-2VB1C224K
4	D1, D2, D3, D4	LED 636NM SUPER RED 0805 SMD	LITE-ON INC	SML-LX0805SIC-TR
2	D5, D6	DIODE SCHOTTKY 20V 0.5A SOD123	ON Semiconductor®	MBR0520LT1G
2	D7, D8	LED THIN 565NM GRN DIFF 0805 SMD	Optoelectronics	SML-LXT0805GW-TR
1	D9	RECT SCHOTTKY 1A 20V DO-214AA	Micro Commercial Co.	SMB5817-TP
4	EA Corner	BUMPON X-TALL TAPER SQ .81X.30BK	3M/ESM	SJ-5523 (BLACK)
1	J1	*Do Not Populate*	—	—
1	J2	CONN POWER JACK 2.5MM PCB CIRC	CUI Inc	PJ-102B
1	J3	*Do Not Populate*	—	—
1	J4	*Do Not Populate*	—	—
2	J5, J10	*Do Not Populate*	—	—
1	J9	CONN USB RTANG FEMALE TYPE B PCB *Do Not Populate*	Assmann Electronics Inc	AU-Y1007-R
1	LCD1	LCD_2x16	Fema	CG1626-SGR1
6	R1, R2, R3, R8, R9, R53	RES 10.0K OHM 1/10W 1% 0805 SMD	Panasonic - ECG	ERJ-6ENF1002V
2	R4, R5	RES 270 OHM 1/8W 5% 0805 SMD	Panasonic - ECG	ERJ-6GEYJ271V
1	R6	RES 523 OHM 1/8W 1% 0805 SMD	Yageo® Corporation	RC0805FR-07523RL
2	R7, R54	RES 4.70K OHM 1/8W 1% 0805 SMD	Yageo Corporation	RC0805FR-074K7L
3	R24, R25, R35	RES 1.00K OHM 1/10W 1% 0805 SMD	Panasonic - ECG	ERJ-6ENF1001V
2	R29, R30	RES 0.0 OHM 1/8W 5% 0805 SMD	Panasonic - ECG	ERJ-6GEY0R00V

Note 1: The components listed in this Bill of Materials are representative of the PCB assembly. The released BOM used in manufacturing uses all RoHS-compliant components.

GPIO Expander Keypad and LCD Demo Board User's Guide

TABLE B-1: BILL OF MATERIALS (CONTINUED)

Qty	Reference Designator	Description	Manufacturer	Part Number
16	R32, R33, R34, R36, R37, R38, R39, R40, R41, R42, R43, R44, R45, R46, R47, R48	RES 100 OHM 1/10W 3900PPM 5%0805	Panasonic - ECG	ERA-S39J101V
1	R49	RES 33.2K OHM 1/8W 1% 0805 SMD	Yageo® Corporation	RC0805FR-0733K2L
2	R50, R52	RES 475 OHM 1/10W 1% 0603 SMD	Panasonic - ECG	ERJ-3EKF4750V
1	R51	RES 100K OHM 1/8W 5% 0805 SMD	Panasonic - ECG	ERJ-6GEYJ104V
17	S11, S12, S13, S14, S15, S16, S17, S18, S19, S20, S21, S22, S23, S24, S25, S26, S27	SWITCH TACT 6MM SMD MOM 160GF	Omron Electronics Inc	B3S-1000
1	TP1	TEST POINT PC MULTI PURPOSE BLK	Keystone Electronics®	5011
1	TP2	TEST POINT PC MULTI PURPOSE RED	Keystone Electronics	5010
1	U1	16 Bit I/O Expander with Serial Interface	Microchip Technology Inc	MCP23S17-E/SS
1	U2	8-Bit I/O Expander with SPI Interface	Microchip Technology Inc	MCP23S08-E/SS
1	U3	16 Bit I/O Expander with Serial Interface	Microchip Technology Inc	MCP23017-E/SS
1	U4	8-Bit I/O Expander with I ² C Interface	Microchip Technology Inc	MCP23008-E/SS
1	U5	44-Pin, High-Performance, Enhanced Flash, USB Microcontroller	Microchip Technology Inc	PIC18F4550
1	U6	2 µA Low Dropout Positive Voltage Regulator	Microchip Technology Inc	MCP1702T-5002I/CB
1	U7	MOSFET P-CH 20V 850MA SSOT3	Fairchild Semiconductor®	NDS352P
1	Y1	CRYSTAL 20.0000 MHZ SERIES RES *Do Not Populate*	CTS-Frequency Controls	ATS200

Note 1: The components listed in this Bill of Materials are representative of the PCB assembly. The released BOM used in manufacturing uses all RoHS-compliant components.

Bill Of Materials (BOM)

NOTES:



WORLDWIDE SALES AND SERVICE

AMERICAS

Corporate Office
2355 West Chandler Blvd.
Chandler, AZ 85224-6199
Tel: 480-792-7200
Fax: 480-792-7277
Technical Support:
<http://support.microchip.com>
Web Address:
www.microchip.com

Atlanta
Alpharetta, GA
Tel: 770-640-0034
Fax: 770-640-0307

Boston
Westborough, MA
Tel: 774-760-0087
Fax: 774-760-0088

Chicago
Itasca, IL
Tel: 630-285-0071
Fax: 630-285-0075

Dallas
Addison, TX
Tel: 972-818-7423
Fax: 972-818-2924

Detroit
Farmington Hills, MI
Tel: 248-538-2250
Fax: 248-538-2260

Kokomo
Kokomo, IN
Tel: 765-864-8360
Fax: 765-864-8387

Los Angeles
Mission Viejo, CA
Tel: 949-462-9523
Fax: 949-462-9608

Santa Clara
Santa Clara, CA
Tel: 408-961-6444
Fax: 408-961-6445

Toronto
Mississauga, Ontario,
Canada
Tel: 905-673-0699
Fax: 905-673-6509

ASIA/PACIFIC

Asia Pacific Office
Suites 3707-14, 37th Floor
Tower 6, The Gateway
Harbour City, Kowloon
Hong Kong
Tel: 852-2401-1200
Fax: 852-2401-3431

Australia - Sydney
Tel: 61-2-9868-6733
Fax: 61-2-9868-6755

China - Beijing
Tel: 86-10-8528-2100
Fax: 86-10-8528-2104

China - Chengdu
Tel: 86-28-8665-5511
Fax: 86-28-8665-7889

China - Fuzhou
Tel: 86-591-8750-3506
Fax: 86-591-8750-3521

China - Hong Kong SAR
Tel: 852-2401-1200
Fax: 852-2401-3431

China - Qingdao
Tel: 86-532-8502-7355
Fax: 86-532-8502-7205

China - Shanghai
Tel: 86-21-5407-5533
Fax: 86-21-5407-5066

China - Shenyang
Tel: 86-24-2334-2829
Fax: 86-24-2334-2393

China - Shenzhen
Tel: 86-755-8203-2660
Fax: 86-755-8203-1760

China - Shunde
Tel: 86-757-2839-5507
Fax: 86-757-2839-5571

China - Wuhan
Tel: 86-27-5980-5300
Fax: 86-27-5980-5118

China - Xian
Tel: 86-29-8833-7250
Fax: 86-29-8833-7256

ASIA/PACIFIC

India - Bangalore
Tel: 91-80-4182-8400
Fax: 91-80-4182-8422

India - New Delhi
Tel: 91-11-4160-8631
Fax: 91-11-4160-8632

India - Pune
Tel: 91-20-2566-1512
Fax: 91-20-2566-1513

Japan - Yokohama
Tel: 81-45-471-6166
Fax: 81-45-471-6122

Korea - Gumi
Tel: 82-54-473-4301
Fax: 82-54-473-4302

Korea - Seoul
Tel: 82-2-554-7200
Fax: 82-2-558-5932 or
82-2-558-5934

Malaysia - Penang
Tel: 60-4-646-8870
Fax: 60-4-646-5086

Philippines - Manila
Tel: 63-2-634-9065
Fax: 63-2-634-9069

Singapore
Tel: 65-6334-8870
Fax: 65-6334-8850

Taiwan - Hsin Chu
Tel: 886-3-572-9526
Fax: 886-3-572-6459

Taiwan - Kaohsiung
Tel: 886-7-536-4818
Fax: 886-7-536-4803

Taiwan - Taipei
Tel: 886-2-2500-6610
Fax: 886-2-2508-0102

Thailand - Bangkok
Tel: 66-2-694-1351
Fax: 66-2-694-1350

EUROPE

Austria - Wels
Tel: 43-7242-2244-39
Fax: 43-7242-2244-393

Denmark - Copenhagen
Tel: 45-4450-2828
Fax: 45-4485-2829

France - Paris
Tel: 33-1-69-53-63-20
Fax: 33-1-69-30-90-79

Germany - Munich
Tel: 49-89-627-144-0
Fax: 49-89-627-144-44

Italy - Milan
Tel: 39-0331-742611
Fax: 39-0331-466781

Netherlands - Drunen
Tel: 31-416-690399
Fax: 31-416-690340

Spain - Madrid
Tel: 34-91-708-08-90
Fax: 34-91-708-08-91

UK - Wokingham
Tel: 44-118-921-5869
Fax: 44-118-921-5820



Стандарт Электрон Связь

Мы молодая и активно развивающаяся компания в области поставок электронных компонентов. Мы поставляем электронные компоненты отечественного и импортного производства напрямую от производителей и с крупнейших складов мира.

Благодаря сотрудничеству с мировыми поставщиками мы осуществляем комплексные и плановые поставки широчайшего спектра электронных компонентов.

Собственная эффективная логистика и склад в обеспечивает надежную поставку продукции в точно указанные сроки по всей России.

Мы осуществляем техническую поддержку нашим клиентам и предпродажную проверку качества продукции. На все поставляемые продукты мы предоставляем гарантию .

Осуществляем поставки продукции под контролем ВП МО РФ на предприятия военно-промышленного комплекса России , а также работаем в рамках 275 ФЗ с открытием отдельных счетов в уполномоченном банке. Система менеджмента качества компании соответствует требованиям ГОСТ ISO 9001.

Минимальные сроки поставки, гибкие цены, неограниченный ассортимент и индивидуальный подход к клиентам являются основой для выстраивания долгосрочного и эффективного сотрудничества с предприятиями радиоэлектронной промышленности, предприятиями ВПК и научно-исследовательскими институтами России.

С нами вы становитесь еще успешнее!

Наши контакты:

Телефон: +7 812 627 14 35

Электронная почта: sales@st-electron.ru

Адрес: 198099, Санкт-Петербург,
Промышленная ул, дом № 19, литера Н,
помещение 100-Н Офис 331