

**LA2000M****Audio Level Sensor**

Overview

LA2000M is an IC for detecting interprogram spaces to pick out the starting point of a program immediately preceding or following a musical program recorded on tape, and to detect end of tape.

Used in

- Radio-cassette recorders
- Cassette decks
- Car stereos

Applications

- Detection of spaces between programs recorded on tape
- Detection of end of tape
- Other

Features

- Has transistors capable of driving plungers with maximum 50 mA, and a protective diode to prevent induced reverse voltages.
- Can provide designated time delays by externally connected capacitors and resistors.
- Has a comparator with stable hysteresis to handle variations in power supply voltage.
- Detects unrecorded portions of tape.

Specifications

Maximum Ratings at $T_a = 25^\circ\text{C}$

Parameter	Symbol	Conditions	Ratings	Unit
Maximum supply voltage	V_{CC} max		15	V
Allowable power dissipation	P_d max		300	mW
Flow-in current	I_6 max		50	mA
Operating temperature	T_{opr}		-20 to +75	$^\circ\text{C}$
Storage temperature	T_{stg}		-40 to +125	$^\circ\text{C}$

- Note:1. The voltage at pin 7 must not exceed the supply voltage at pin 8.
2. The maximum current flowing into pin 7 should be no greater than 0.5 mA.

Package Dimensions

unit : mm

3032B-MFP8

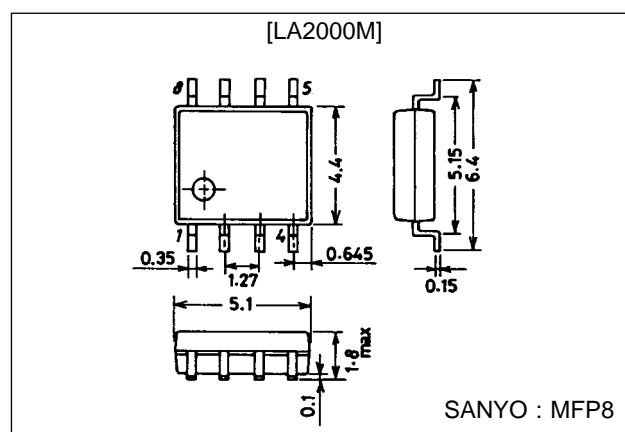

LA2000M

Operating Conditions at $T_a = 25^\circ\text{C}$

Parameter	Symbol	Conditions	Ratings	Unit
Operating supply voltage	$V_{CC\text{ op}}$		3.5 to 14	V

Operating Characteristics at $T_a = 25^\circ\text{C}$, $V_{CC} = 9.0\text{ V}$, $f = 1\text{ kHz}$

Parameter	Symbol	Conditions	min	typ	max	Unit
Circuit current	I_{CC}	$f = 1\text{ kHz}$, $V_{IN} = -45\text{ dBm}$		6	12	mA
Output transistor saturating voltage	$V_{CE\text{ (sat)}}$	$I_6 = 50\text{ mA}$		0.5	1.8	V
Output diode forward voltage	V_F	$I_F = 50\text{ mA}$		0.7	1.5	V
Output-off level in input equivalent	V_{IN}	$f = 1\text{ kHz}$	-43	-50	-54	dBm
Comparator-on level	V_{TH-H}		3.0	3.5	4.0	V
Comparator-off level	V_{TH-L}		1.8	2.2	2.6	V
Pin 7 high level	$V_7\text{ pin}$		0.45	0.55		V
Output transistor leakage current	I_{L-TR}				100	μA
Output diode leakage current	I_{L-Di}				100	μA

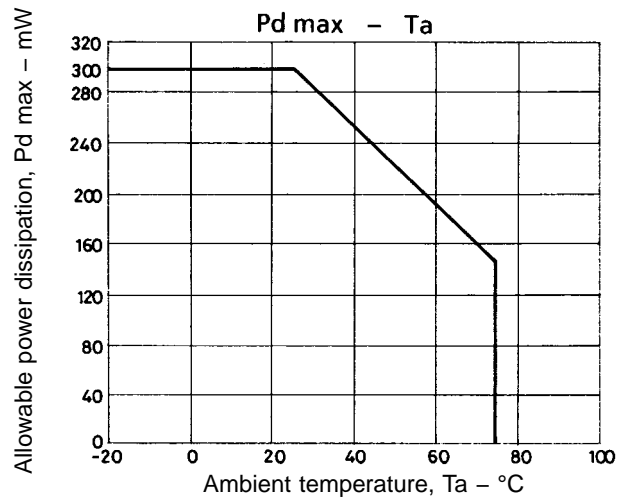

Equivalent Circuit Block Diagram

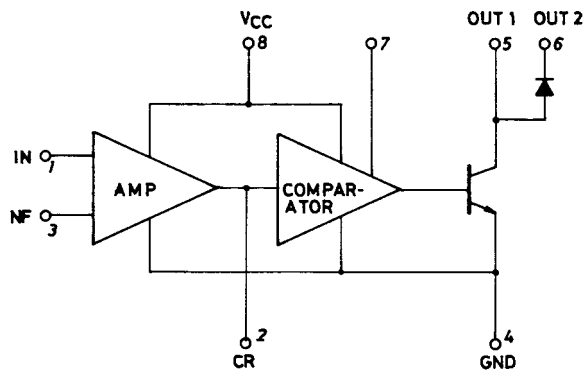

LA2000M

Sample Application Circuit 2

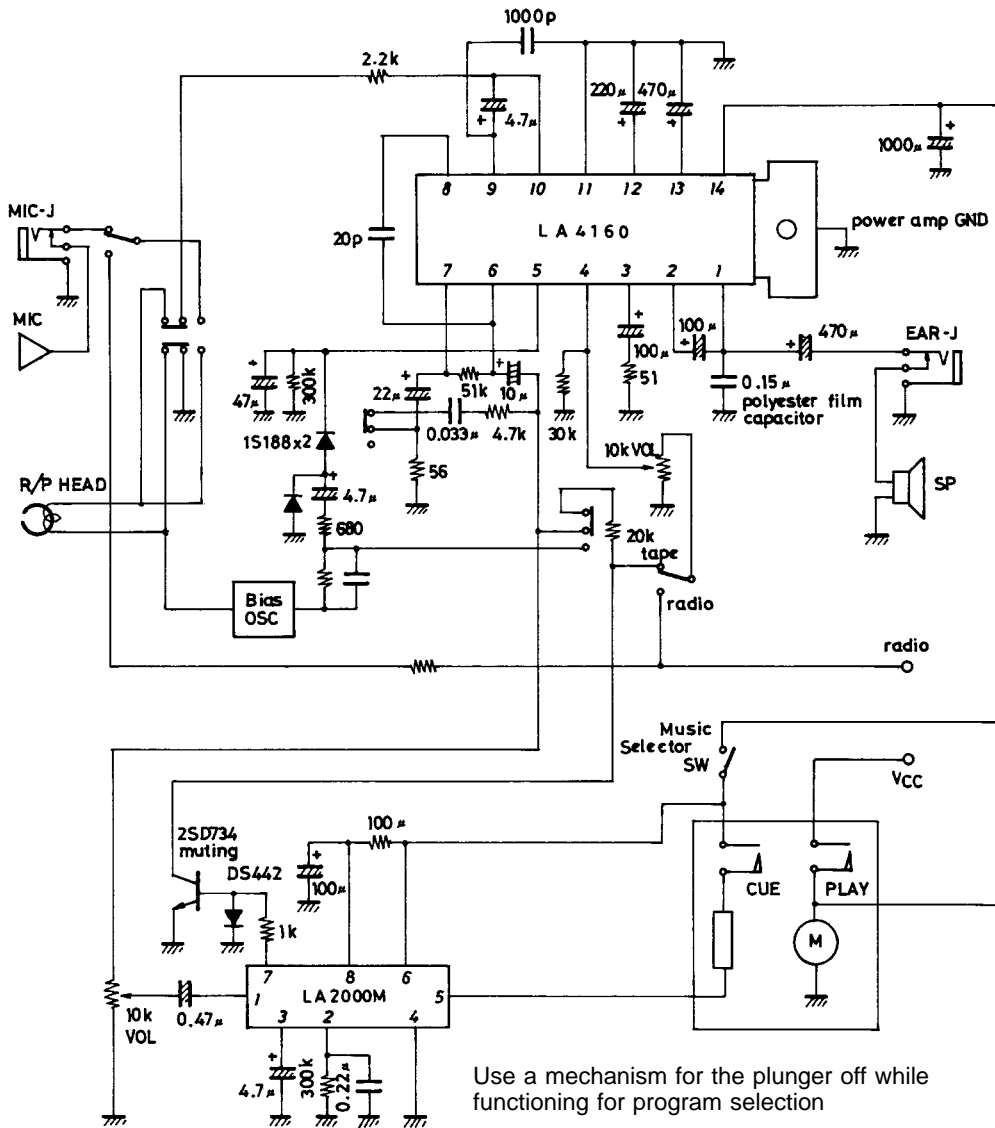

Unit (resistance: Ω , capacitance: F)

1. Externally connected components

C1	Input coupling capacitor	0.47 to 2.2 μ F recommended.
C2	NF capacitor	Capacitance is reduced, so the off level in input equivalent becomes lower in the bass frequency range. We recommend 1 to 10 μ F.
C3, R1	For designation of time delays	Any time delay can be obtained by adequate choice of C3 and R1. We recommend 150 k Ω to 500 k Ω for R1.
C4, R3	Power supply ripple filter	
R2	Bias resistor	For diode when pin 7 is used to drive external transistors. A 1 k Ω resistor is recommended.

2. Individual pins and their operations

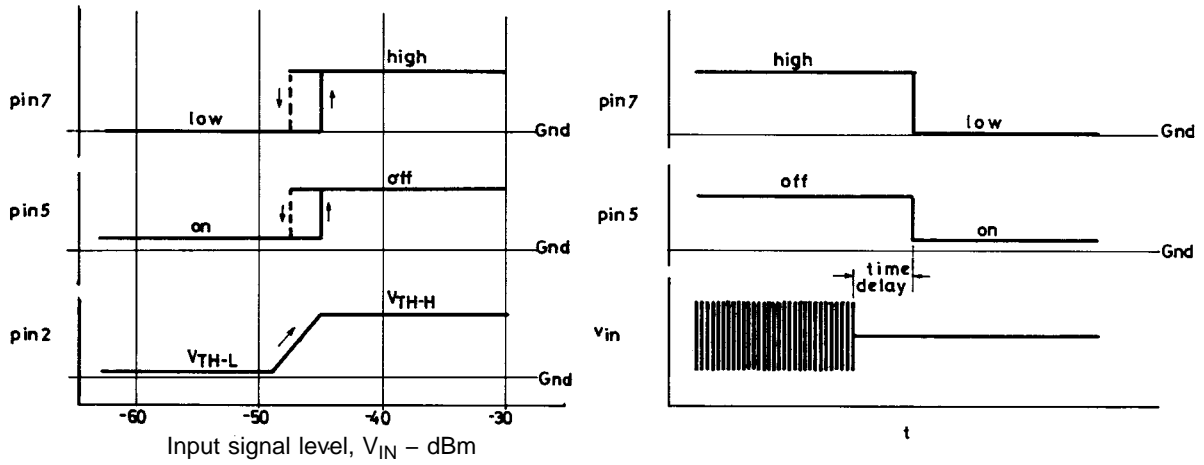

As shown above, when input level is raised and the pin 2 voltage reaches the V_{TH-H} level of the comparator, pins 5 and 7 turn over. ($V_{IN} = -45$ dBm).

- pin 5 is for driving plungers. When it is on the “L” side, pin 5 turns on and can draw current up to 50 mA maximum.
- Pin 6 is a diode that prevents reverse voltages induced when the plunger is turned off from on.
- Pin 7 functions in phase with pin 5 and can drive external transistors (such as for MUTE).

3. Time delays and obtaining CRs

When input signals that have been applied at a level not less than -45 dBm are removed, discharging occurs through the CR connected at pin 2, lowering pin 2 potential. A time delay is provided before the hysteresis comparator turns over.

$$\frac{E1}{E0} = - \frac{t}{e^\tau}$$

$E0$: Initial voltage
 $E1$: Threshold voltage
 τ : Time constant

Accordingly,

$$t = -\tau \ln \frac{E1}{E0}$$

$E1/E0$, within the IC, is 0.26. A desired time delay is obtained by an appropriate choice of τ ($\tau = C_3R_1$). Therefore, the time delay is obtained by the following formula:

$$t = 1.34 \times C_3R_1 \text{ (sec)}$$

We recommend $150 \text{ k}\Omega$ to $500 \text{ k}\Omega$ for R when determining CR.

4. IC usage notes

- Maximum ratings
When maximum ratings are surpassed, destruction or deterioration may result.
- Interpin short circuits and reverse insertions
These cause destruction or deterioration of the IC: be careful when mounting on circuit board.
- Voltage applied to pin 7 should never exceed pin 8 voltage.
- The current flowing into pin 7 is to be 0.5 mA maximum.

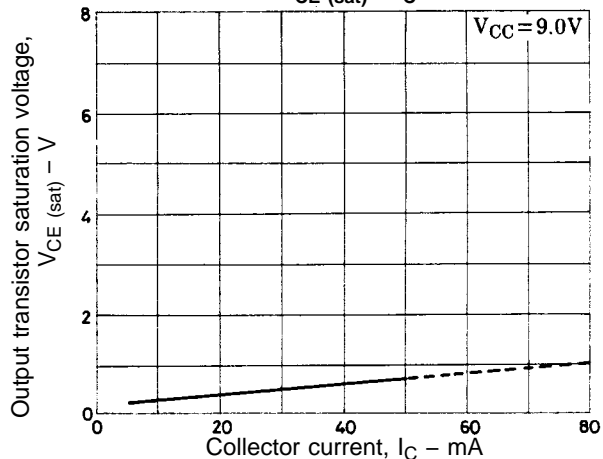
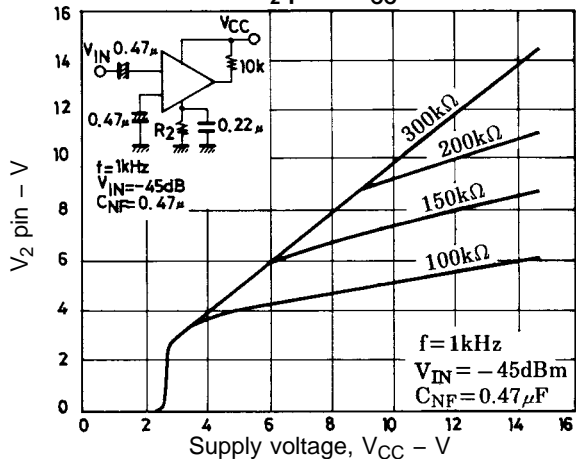
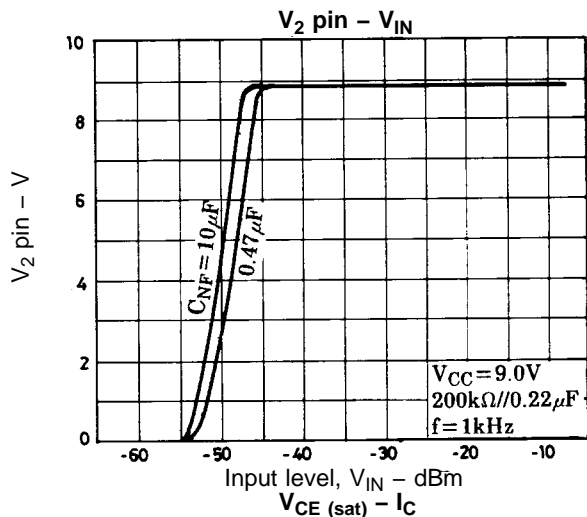
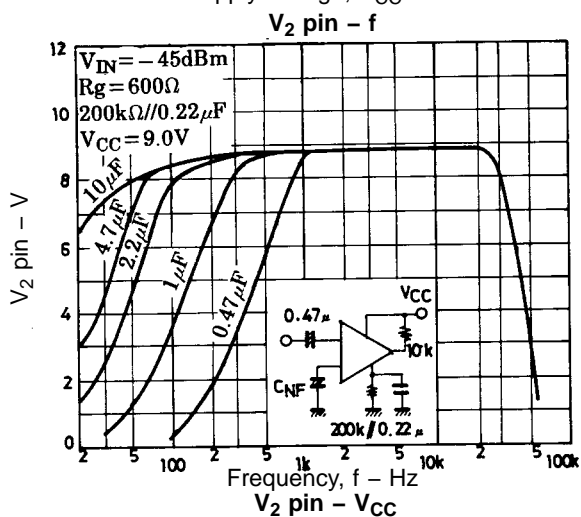
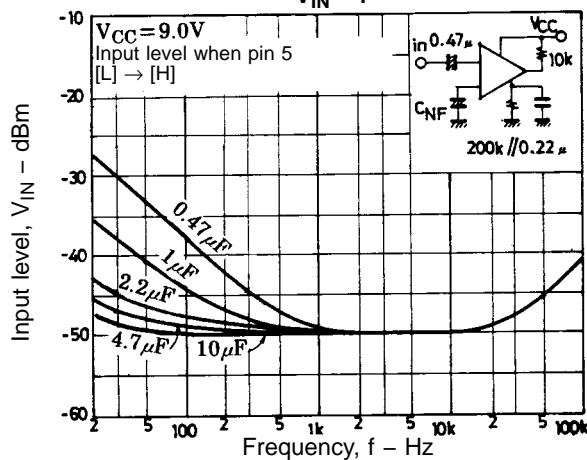
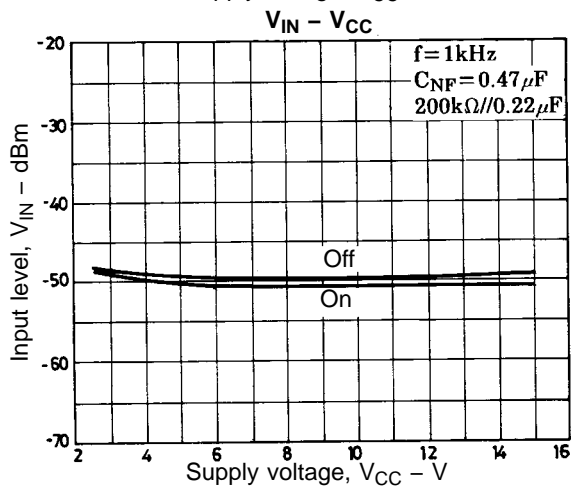
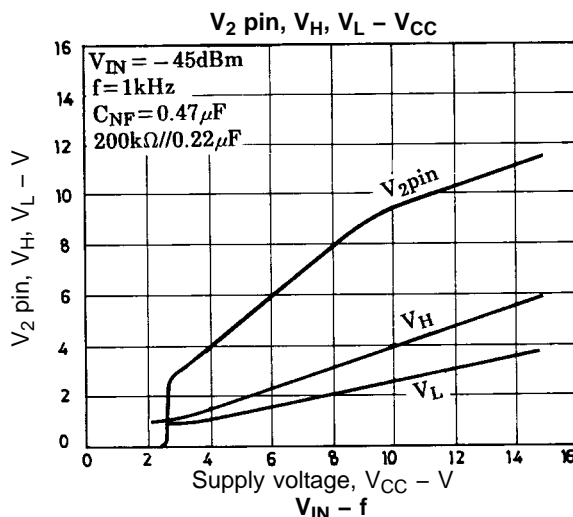
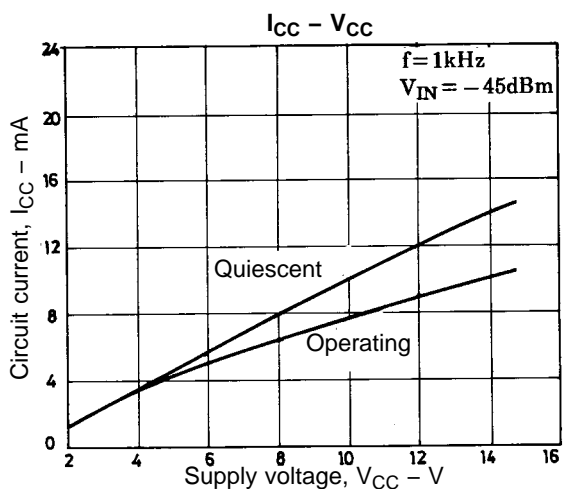

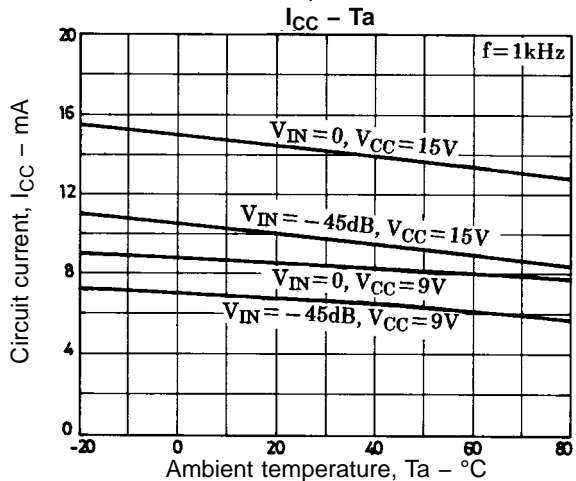
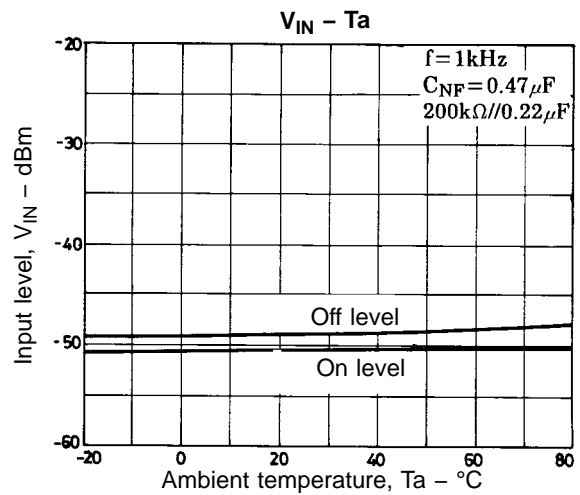
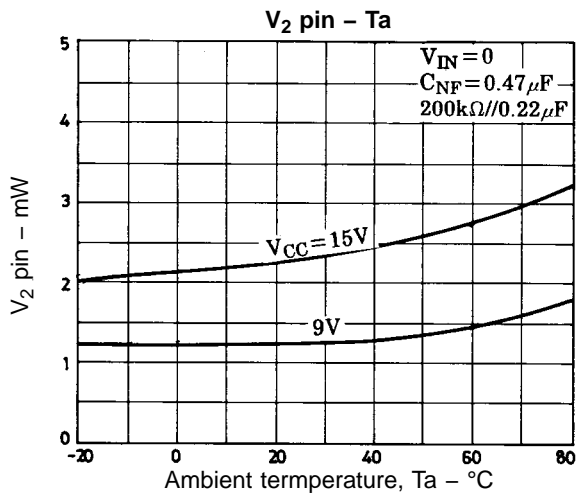
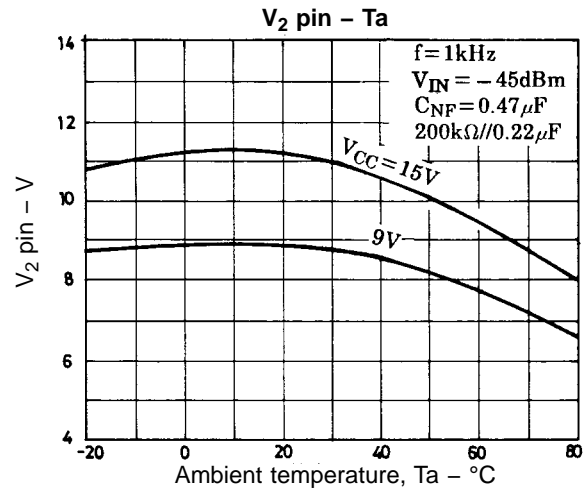
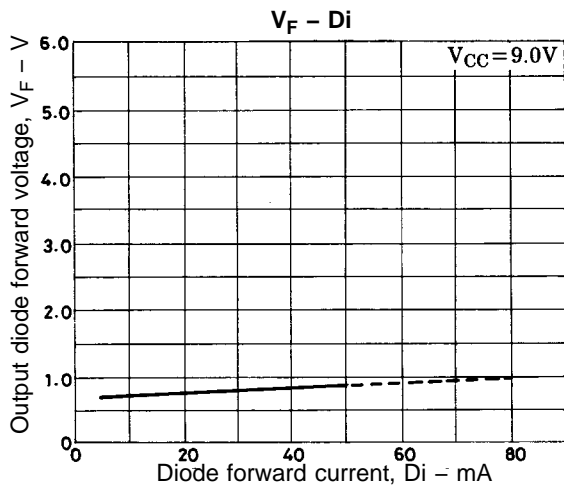

- No products described or contained herein are intended for use in surgical implants, life-support systems, aerospace equipment, nuclear power control systems, vehicles, disaster/crime-prevention equipment and the like, the failure of which may directly or indirectly cause injury, death or property loss.
- Anyone purchasing any products described or contained herein for an above-mentioned use shall:
 - ① Accept full responsibility and indemnify and defend SANYO ELECTRIC CO., LTD., its affiliates, subsidiaries and distributors and all their officers and employees, jointly and severally, against any and all claims and litigation and all damages, cost and expenses associated with such use:
 - ② Not impose any responsibility for any fault or negligence which may be cited in any such claim or litigation on SANYO ELECTRIC CO., LTD., its affiliates, subsidiaries and distributors or any of their officers and employees jointly or severally.
- Information (including circuit diagrams and circuit parameters) herein is for example only; it is not guaranteed for volume production. SANYO believes information herein is accurate and reliable, but no guarantees are made or implied regarding its use or any infringements of intellectual property rights or other rights of third parties.

This catalog provides information as of April, 1996. Specifications and information herein are subject to change without notice.



Стандарт Электрон Связь

Мы молодая и активно развивающаяся компания в области поставок электронных компонентов. Мы поставляем электронные компоненты отечественного и импортного производства напрямую от производителей и с крупнейших складов мира.

Благодаря сотрудничеству с мировыми поставщиками мы осуществляем комплексные и плановые поставки широчайшего спектра электронных компонентов.

Собственная эффективная логистика и склад в обеспечивает надежную поставку продукции в точно указанные сроки по всей России.

Мы осуществляем техническую поддержку нашим клиентам и предпродажную проверку качества продукции. На все поставляемые продукты мы предоставляем гарантию .

Осуществляем поставки продукции под контролем ВП МО РФ на предприятия военно-промышленного комплекса России , а также работаем в рамках 275 ФЗ с открытием отдельных счетов в уполномоченном банке. Система менеджмента качества компании соответствует требованиям ГОСТ ISO 9001.

Минимальные сроки поставки, гибкие цены, неограниченный ассортимент и индивидуальный подход к клиентам являются основой для выстраивания долгосрочного и эффективного сотрудничества с предприятиями радиоэлектронной промышленности, предприятиями ВПК и научно-исследовательскими институтами России.

С нами вы становитесь еще успешнее!

Наши контакты:

Телефон: +7 812 627 14 35

Электронная почта: sales@st-electron.ru

Адрес: 198099, Санкт-Петербург,
Промышленная ул, дом № 19, литера Н,
помещение 100-Н Офис 331