

# HiPerFAST™ IGBT Lightspeed™ Series

**IXGH 12N90C**  
**IXGX 12N90C**

$V_{CES} = 900 \text{ V}$   
 $I_{C25} = 24 \text{ A}$   
 $V_{CES(sat)} = 3.0 \text{ V}$   
 $t_{fi(typ)} = 70 \text{ ns}$

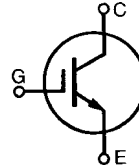

Symbol	Test Conditions	Maximum Ratings	
$V_{CES}$	$T_J = 25^\circ\text{C to } 150^\circ\text{C}$	900	V
$V_{CGR}$	$T_J = 25^\circ\text{C to } 150^\circ\text{C}; R_{GE} = 1 \text{ M}\Omega$	900	V
$V_{GES}$	Continuous	$\pm 20$	V
$V_{GEM}$	Transient	$\pm 30$	V
$I_{C25}$	$T_C = 25^\circ\text{C}$	24	A
$I_{C90}$	$T_C = 90^\circ\text{C}$	12	A
$I_{CM}$	$T_C = 25^\circ\text{C}, 1 \text{ ms}$	48	A
<b>SSOA (RBSOA)</b>	$V_{GE} = 15 \text{ V}, T_{VJ} = 125^\circ\text{C}, R_G = 33 \Omega$ Clamped inductive load	$I_{CM} = 24$ @ $0.8 V_{CES}$	A
$P_C$	$T_C = 25^\circ\text{C}$	100	W
$T_J$		-55 ... +150	$^\circ\text{C}$
$T_{JM}$		150	$^\circ\text{C}$
$T_{stg}$		-55 ... +150	$^\circ\text{C}$
$M_d$	Mounting torque with screw M3 Mounting torque with screw M3.5	0.45/4 Nm/lb.in. 0.55/5 Nm/lb.in.	
Maximum lead temperature for soldering 1.6 mm (0.062 in.) from case for 10 s		300	$^\circ\text{C}$
<b>Weight</b>		6	g

## TO-247 (IXGH)

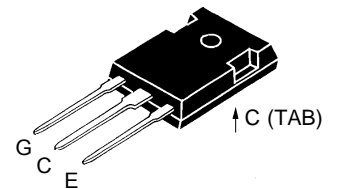

## PLUS 247 (IXGX)

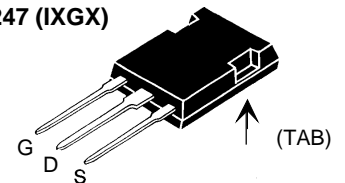

G = Gate, C = Collector,  
E = Emitter, TAB = Collector

## Features

- Very high frequency IGBT
- New generation HDMOS™ process
- International standard package
- High peak current handling capability

## Applications

- PFC circuit
- AC motor speed control
- DC servo and robot drives
- Switch-mode and resonant-mode power supplies
- High power audio amplifiers

## Advantages

- Fast switching speed
- High power density

Symbol	Test Conditions	Characteristic Values ( $T_J = 25^\circ\text{C}$ , unless otherwise specified)		
		min.	typ.	max.
$BV_{CES}$	$I_C = 250 \mu\text{A}, V_{GE} = 0 \text{ V}$	900		V
$V_{GE(th)}$	$I_C = 250 \mu\text{A}, V_{GE} = V_{GE}$	2.5		5.0 V
$I_{CES}$	$V_{CE} = V_{CES}, V_{GE} = 0 \text{ V}$			$T_J = 25^\circ\text{C}$ : 100 $\mu\text{A}$ $T_J = 125^\circ\text{C}$ : 1.5 mA
$I_{GES}$	$V_{CE} = 0 \text{ V}, V_{GE} = \pm 20 \text{ V}$			$\pm 100 \text{ nA}$
$V_{CE(sat)}$	$I_C = I_{CE90}, V_{GE} = 15 \text{ V}$			3.0 V

Symbol	Test Conditions	Characteristic Values ( $T_J = 25^\circ\text{C}$ , unless otherwise specified)			
		min.	typ.	max.	
$g_{fs}$	$I_C = I_{C90}, V_{CE} = 10\text{ V}$ , Pulse test, $t \leq 300\ \mu\text{s}$ , duty cycle $\leq 2\%$	5	10	S	
$C_{ies}$	$V_{CE} = 25\text{ V}, V_{GE} = 0\text{ V}, f = 1\text{ MHz}$		780	pF	
$C_{oes}$			60	pF	
$C_{res}$			15	pF	
$Q_g$	$I_C = I_{C90}, V_{GE} = 15\text{ V}, V_{CE} = 0.5 V_{CES}$		33	nC	
$Q_{ge}$			10	nC	
$Q_{gc}$			12	nC	
$t_{d(on)}$	<b>Inductive load, <math>T_J = 25^\circ\text{C}</math></b> $I_C = I_{C90}, V_{GE} = 15\text{ V}$ $V_{CE} = 0.8 \cdot V_{CES}, R_G = R_{off} = 22\ \Omega$ Remarks: Switching times may increase for $V_{CE}(\text{Clamp}) > 0.8 \cdot V_{CES}$ , higher $T_J$ or increased $R_G$		20	ns	
$t_{ri}$			20	ns	
$t_{d(off)}$			135	200	ns
$t_{fi}$			70	180	ns
$E_{off}$			0.32	0.70	mJ
$t_{d(on)}$	<b>Inductive load, <math>T_J = 125^\circ\text{C}</math></b> $I_C = I_{C90}, V_{GE} = 15\text{ V}$ $V_{CE} = 0.8 \cdot V_{CES}, R_G = R_{off} = 22\ \Omega$ Remarks: Switching times may increase for $V_{CE}(\text{Clamp}) > 0.8 \cdot V_{CES}$ , higher $T_J$ or increased $R_G$		20	ns	
$t_{ri}$			20	ns	
$E_{on}$			0.15	mJ	
$t_{d(off)}$			200	ns	
$t_{fi}$			150	ns	
$E_{off}$		0.70	mJ		
$R_{thJC}$			1.25	K/W	
$R_{thCK}$	TO-247 PLUS 247	0.25 0.15		K/W K/W	

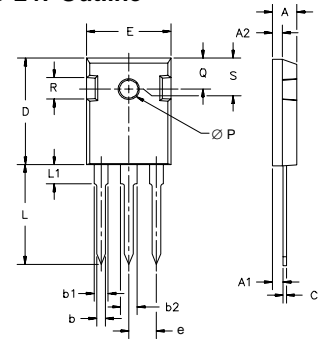
**TO-247 Outline**

Dim.	Millimeter		Inches	
	Min.	Max.	Min.	Max.
A	4.7	5.3	.185	.209
A <sub>1</sub>	2.2	2.54	.087	.102
A <sub>2</sub>	2.2	2.6	.087	.102
b	1.0	1.4	.040	.055
b <sub>1</sub>	1.65	2.13	.065	.084
b <sub>2</sub>	2.87	3.12	.113	.123
C	.4	.8	.016	.031
D	20.80	21.46	.819	.845
E	15.75	16.26	.610	.640
e	5.20	5.72	0.205	0.225
L	19.81	20.32	.780	.800
L <sub>1</sub>		4.50		.177
∅P	3.55	3.65	.140	.144
Q	5.89	6.40	0.232	0.252
R	4.32	5.49	.170	.216
S	6.15	BSC	.242	BSC

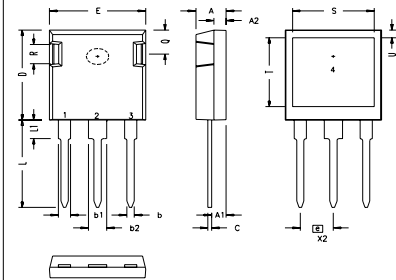
**PLUS 247 Outline**

SYM	INCHES		MILLIMETERS	
	MIN	MAX	MIN	MAX
A	.190	.205	4.83	5.21
A <sub>1</sub>	.090	.100	2.29	2.54
A <sub>2</sub>	.075	.085	1.91	2.16
b	.045	.055	1.14	1.40
b <sub>1</sub>	.075	.084	1.91	2.13
b <sub>2</sub>	.115	.123	2.92	3.12
C	.024	.031	0.61	0.80
D	.819	.840	20.80	21.34
E	.620	.635	15.75	16.13
e	.215 BSC		5.45 BSC	
L	.780	.800	19.81	20.32
L <sub>1</sub>	.150	.170	3.81	4.32
Q	.220	.244	5.59	6.20
R	.170	.190	4.32	4.83
S	.520	.540	13.21	13.72
T	.620	.640	15.75	16.26
U	.065	.080	1.65	2.03

- 1 - GATE
- 2 - DRAIN (COLLECTOR)
- 3 - SOURCE (EMITTER)
- 4 - NO CONNECTION

NOTE: This drawing will meet all dimensions requirement of JEDEC outline TO-247AD except screw hole.

IXYS reserves the right to change limits, test conditions, and dimensions.

Fig. 1. Saturation Voltage Characteristics @ 25°C

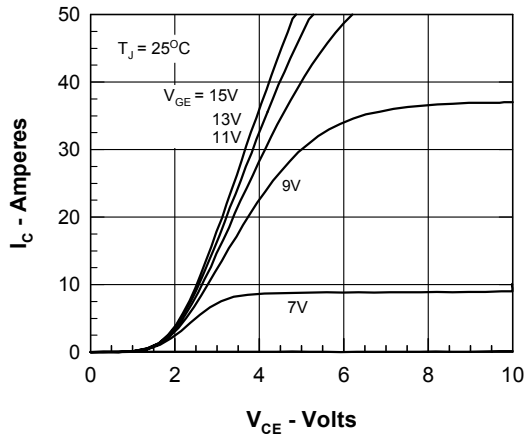

Fig. 2. Extended Output Characteristics

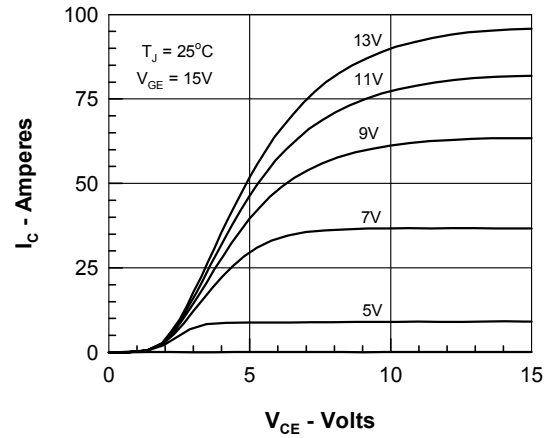

Fig. 3. Saturation Voltage Characteristics @ 125°C

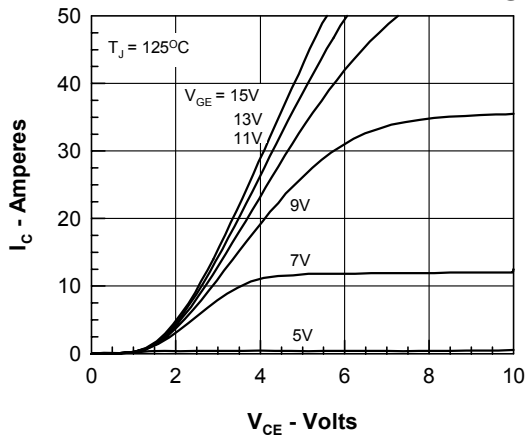

Fig. 4. Temperature Dependence of  $V_{CE(SAT)}$

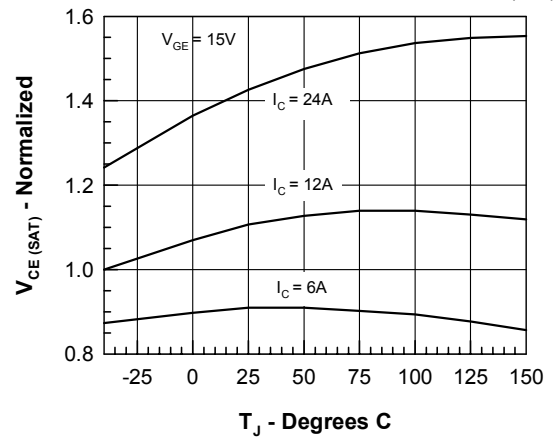

Fig. 5. Admittance Curves

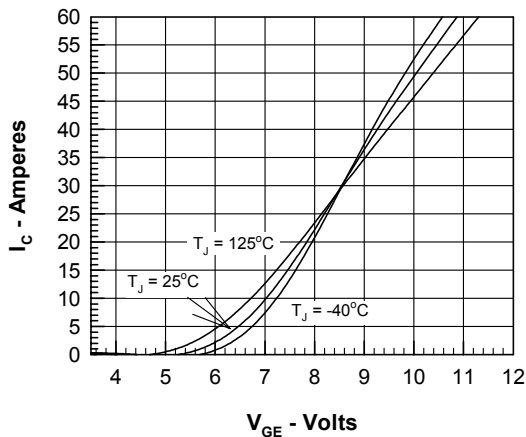

Fig. 6. Capacitance Curves

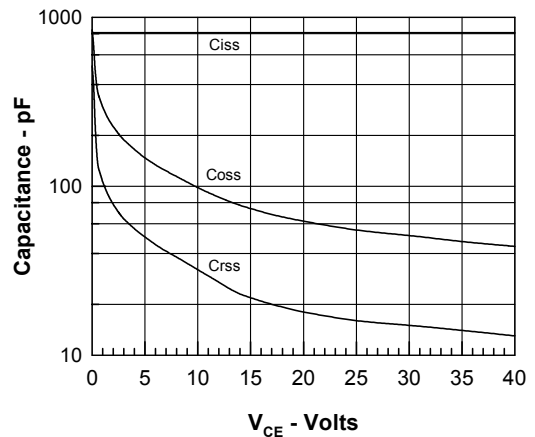

Fig. 7. Dependence of  $E_{OFF}$  on  $I_C$

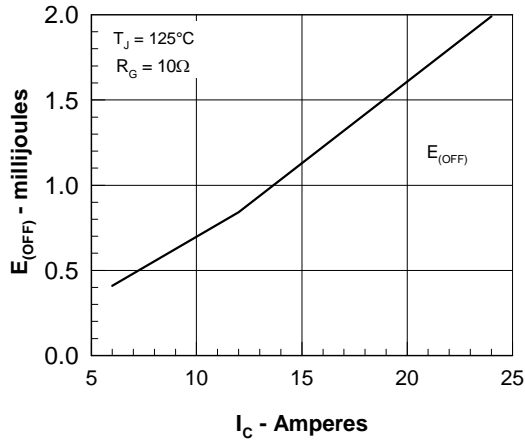

Fig. 8. Dependence of  $E_{OFF}$  on  $R_G$

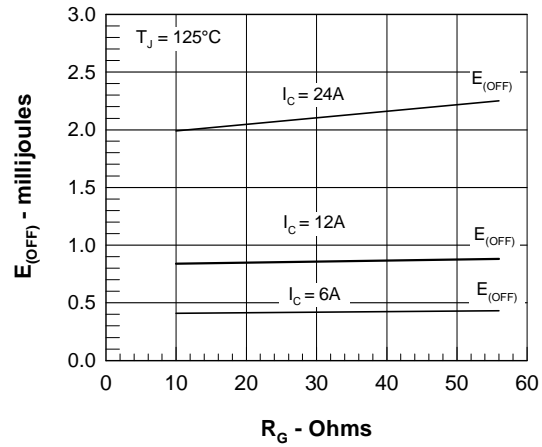

Fig. 9. Gate Charge

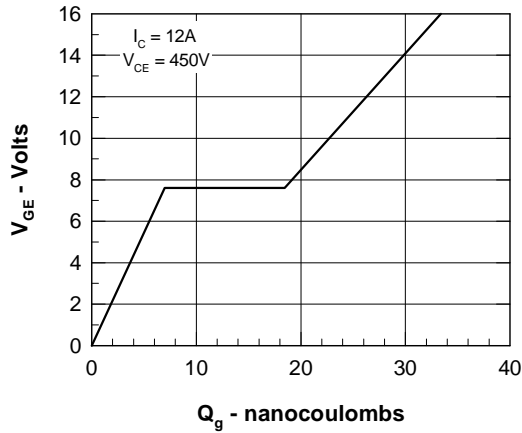

Fig. 10. Turn-off Safe Operating Area

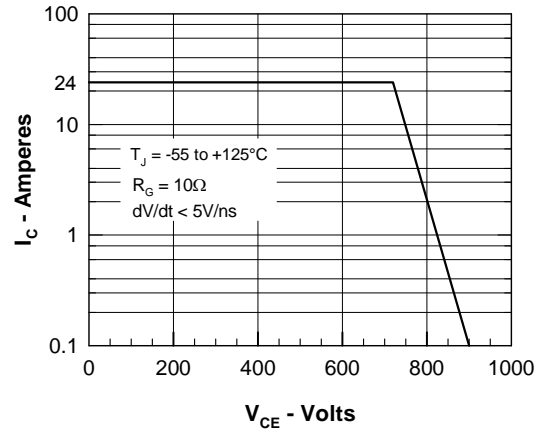
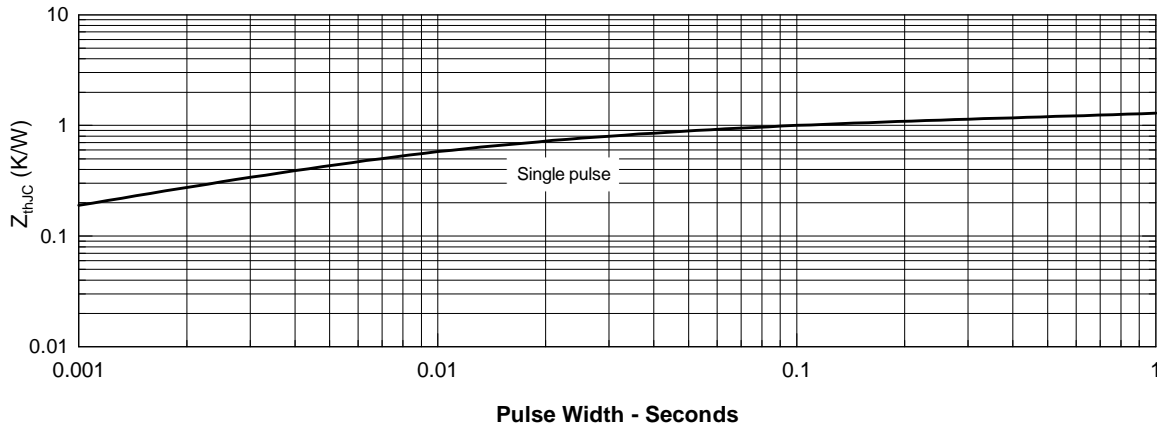

Fig. 11. Transient Thermal Resistance



IXYS reserves the right to change limits, test conditions, and dimensions.

IXYS MOSFETs and IGBTs are covered by one or more of the following U.S. patents:

4,835,592 4,881,106 5,017,508 5,049,961 5,187,117 5,486,715 6,306,728B1 6,259,123B1 6,306,728B1  
4,850,072 4,931,844 5,034,796 5,063,307 5,237,481 5,381,025 6,404,065B1 6,162,665 6,534,343



## Стандарт Электрон Связь

Мы молодая и активно развивающаяся компания в области поставок электронных компонентов. Мы поставляем электронные компоненты отечественного и импортного производства напрямую от производителей и с крупнейших складов мира.

Благодаря сотрудничеству с мировыми поставщиками мы осуществляем комплексные и плановые поставки широчайшего спектра электронных компонентов.

Собственная эффективная логистика и склад в обеспечивает надежную поставку продукции в точно указанные сроки по всей России.

Мы осуществляем техническую поддержку нашим клиентам и предпродажную проверку качества продукции. На все поставляемые продукты мы предоставляем гарантию .

Осуществляем поставки продукции под контролем ВП МО РФ на предприятия военно-промышленного комплекса России , а также работаем в рамках 275 ФЗ с открытием отдельных счетов в уполномоченном банке. Система менеджмента качества компании соответствует требованиям ГОСТ ISO 9001.

Минимальные сроки поставки, гибкие цены, неограниченный ассортимент и индивидуальный подход к клиентам являются основой для выстраивания долгосрочного и эффективного сотрудничества с предприятиями радиоэлектронной промышленности, предприятиями ВПК и научно-исследовательскими институтами России.

С нами вы становитесь еще успешнее!

### Наши контакты:

**Телефон:** +7 812 627 14 35

**Электронная почта:** [sales@st-electron.ru](mailto:sales@st-electron.ru)

**Адрес:** 198099, Санкт-Петербург,  
Промышленная ул, дом № 19, литера Н,  
помещение 100-Н Офис 331