

## FEATURES

- Trimmed to High Accuracy: 0.075% Max
- Low Drift: 10ppm/°C Max
- Industrial Temperature Range
- Temperature Coefficient Guaranteed to 125°C
- Low Supply Current: 130µA Max (LT1460-2.5)
- Minimum Output Current: 20mA
- No Output Capacitor Required
- Reverse Battery Protection
- Minimum Input/Output Differential: 0.9V
- Available in SO-8, MSOP-8, PDIP-8, TO-92 and SOT- 23 Package

## APPLICATIONS

- Handheld Instruments
- Precision Regulators
- A/D and D/A Converters
- Power Supplies
- Hard Disk Drives

## DESCRIPTION

The LT®1460 is a micropower bandgap reference that combines very high accuracy and low drift with low power dissipation and small package size. This series reference uses curvature compensation to obtain low temperature coefficient and trimmed precision thin-film resistors to achieve high output accuracy. The reference will supply up to 20mA with excellent line regulation characteristics, making it ideal for precision regulator applications.

This series reference provides supply current and power dissipation advantages over shunt references that must idle the entire load current to operate. Additionally, the LT1460 does not require an output compensation capacitor, yet is stable with capacitive loads. This feature is important where PC board space is a premium or fast settling is demanded. In the event of a reverse battery connection, these references will not conduct current, and are therefore protected from damage.

The LT1460 is available in the 8-lead MSOP, SO, PDIP and the 3-lead TO-92 and SOT23 packages.

**LT**, LTC and LT are registered trademarks of Linear Technology Corporation. All other trademarks are the property of their respective owners.

## TYPICAL APPLICATION

Basic Connection

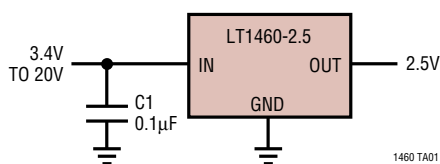

Typical Distribution of Output Voltage  
 S8 Package

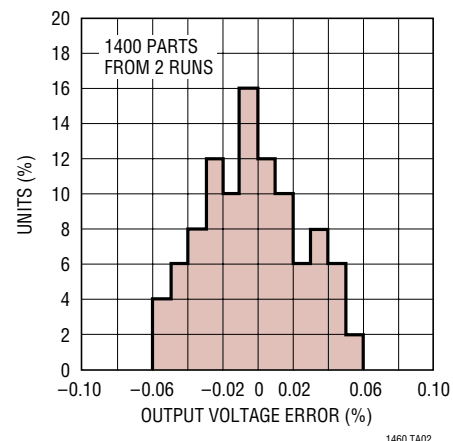

## ABSOLUTE MAXIMUM RATINGS

(Note 1)

Input Voltage.....	30V
Reverse Voltage.....	-15V
Output Short-Circuit Duration, $T_A = 25^\circ\text{C}$	
$V_{IN} > 10\text{V}$ .....	5 sec
$V_{IN} \leq 10\text{V}$ .....	Indefinite

Specified Temperature Range	
Commercial (C).....	0°C to 70°C
Industrial (I).....	-40°C to 85°C
High (H).....	-40°C to 125°C
Storage Temperature Range (Note 2).....	-65°C to 150°C
Lead Temperature (Soldering, 10 sec).....	300°C

## PACKAGE/ORDER INFORMATION

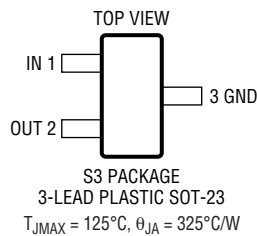

	ORDER PART NUMBER	S3 PART MARKING†
	LT1460HCS3-2.5	LTAC
	LT1460JCS3-2.5	LTAD
	LT1460KCS3-2.5	LTAE
	LT1460HCS3-3	LTAN
	LT1460JCS3-3	LTAP
	LT1460KCS3-3	LTAQ
	LT1460HCS3-3.3	LTAR
	LT1460JCS3-3.3	LTAS
	LT1460KCS3-3.3	LTAT
	LT1460HCS3-5	LTAK
	LT1460JCS3-5	LTAL
	LT1460KCS3-5	LTAM
	LT1460HCS3-10	LTAU
	LT1460JCS3-10	LTAV
	LT1460KCS3-10	LTAW

\*The temperature grades and parametric grades are identified by a label on the shipping container. †Product may be identified with either part marking.

# PACKAGE/ORDER INFORMATION

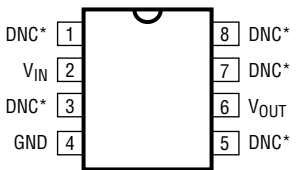
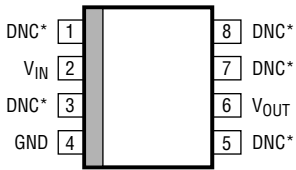
<p style="text-align: center;">TOP VIEW</p>  <p style="text-align: center;">N8 PACKAGE 8-LEAD PLASTIC DIP</p> <p style="text-align: center;">*CONNECTED INTERNALLY. DO NOT CONNECT EXTERNAL CIRCUITRY TO THESE PINS <math>T_{JMAX} = 150^{\circ}C</math>, <math>\theta_{JA} = 130^{\circ}C/W</math></p>	ORDER PART NUMBER	
	LT1460ACN8-2.5 LT1460BIN8-2.5 LT1460DCN8-2.5 LT1460EIN8-2.5	
	LT1460ACN8-5 LT1460BIN8-5 LT1460DCN8-5 LT1460EIN8-5	
		LT1460ACN8-10 LT1460BIN8-10 LT1460DCN8-10 LT1460EIN8-10
<p style="text-align: center;">TOP VIEW</p>  <p style="text-align: center;">S8 PACKAGE 8-LEAD PLASTIC SO</p> <p style="text-align: center;">*CONNECTED INTERNALLY. DO NOT CONNECT EXTERNAL CIRCUITRY TO THESE PINS <math>T_{JMAX} = 150^{\circ}C</math>, <math>\theta_{JA} = 190^{\circ}C/W</math></p>	ORDER PART NUMBER	S8 PART MARKING
	LT1460ACS8-2.5 LT1460BIS8-2.5 LT1460DCS8-2.5 LT1460EIS8-2.5 LT1460LHS8-2.5 LT1460MHS8-2.5	1460A2 460BI2 1460D2 460EI2 60LH25 60MH25
	LT1460ACS8-5 LT1460BIS8-5 LT1460DCS8-5 LT1460EIS8-5 LT1460LHS8-5 LT1460MHS8-5	1460A5 460BI5 1460D5 460EI5 460LH5 460MH5
	LT1460ACS8-10 LT1460BIS8-10 LT1460DCS8-10 LT1460EIS8-10	1460A1 460BI1 1460D1 460EI1

## PACKAGE/ORDER INFORMATION

<p style="text-align: center;">TOP VIEW</p> <p style="text-align: center;">MS8 PACKAGE 8-LEAD PLASTIC MSOP</p> <p style="text-align: center;">*CONNECTED INTERNALLY. DO NOT CONNECT EXTERNAL CIRCUITRY TO THESE PINS <math>T_{JMAX} = 150^{\circ}\text{C}</math>, <math>\theta_{JA} = 250^{\circ}\text{C/W}</math></p>		<p style="text-align: center;">BOTTOM VIEW</p> <p style="text-align: center;">Z PACKAGE 3-LEAD TO-92 PLASTIC <math>T_{JMAX} = 150^{\circ}\text{C}</math>, <math>\theta_{JA} = 160^{\circ}\text{C/W}</math></p>	
ORDER PART NUMBER	MS8 PART MARKING	ORDER PART NUMBER	
LT1460CCMS8-2.5	LTAA	LT1460GCZ-2.5	
LT1460FCMS8-2.5	LTAB	LT1460GIZ-2.5	
LT1460CCMS8-5	LTAJ	LT1460GCZ-5	
LT1460FCMS8-5	LTAG	LT1460GIZ-5	
LT1460CCMS8-10	LTAH	LT1460GCZ-10	
LT1460FCMS8-10	LTAJ	LT1460GIZ-10	
<p><b>Order Options</b> Tape and Reel: Add #TR Lead Free: Add #PBF Lead Free Tape and Reel: Add #TRPBF Lead Free Part Marking: <a href="http://www.linear.com/leadfree/">http://www.linear.com/leadfree/</a></p>			

Consult LTC Marketing for parts specified with wider operating temperature ranges.

## AVAILABLE OPTIONS

TEMPERATURE	ACCURACY (%)	TEMPERATURE COEFFICIENT (ppm/°C)	PACKAGE TYPE				
			N8	S8	MS8	Z	S3
0°C to 70°C	0.075	10	LT1460ACN8	LT1460ACS8			
-40°C to 85°C	0.10	10	LT1460BIN8	LT1460BIS8			
0°C to 70°C	0.10	15			LT1460CCMS8		
0°C to 70°C	0.10	20	LT1460DCN8	LT1460DCS8			
-40°C to 85°C	0.125	20	LT1460EIN8	LT1460EIS8			
0°C to 70°C	0.15	25			LT1460FCMS8		
0°C to 70°C	0.25	25				LT1460GCZ	
-40°C to 85°C	0.25	25				LT1460GIZ	
-40°C to 85°C/125°C	0.20	20/50		LT1460LHS8			
-40°C to 125°C	0.20	50		LT1460MHS8			
0°C to 70°C	0.20	20					LT1460HCS3
0°C to 70°C	0.40	20					LT1460JCS3
0°C to 70°C	0.50	50					LT1460KCS3

**ELECTRICAL CHARACTERISTICS** The ● denotes the specifications which apply over the full operating temperature range, otherwise specifications are at  $T_A = 25^\circ\text{C}$ .  $V_{IN} = V_{OUT} + 2.5\text{V}$ ,  $I_{OUT} = 0$  unless otherwise specified.

PARAMETER	CONDITIONS	MIN	TYP	MAX	UNITS	
Output Voltage	LT1460ACN8-2.5, ACS8-2.5	2.49813 -0.075		2.50188 0.075	V %	
	LT1460BIN8-2.5, BIS8-2.5, CCMS8-2.5, DCN8-2.5, DCS8-2.5	2.4975 -0.10		2.5025 0.10	V %	
	LT1460EIN8-2.5, EIS8-2.5	2.49688 -0.125		2.50313 0.125	V %	
	LT1460FCMS8-2.5	2.49625 -0.15		2.50375 0.15	V %	
	LT1460GCZ-2.5, GIZ-2.5	2.49375 -0.25		2.50625 0.25	V %	
	LT1460LHS8-2.5, MHS8-2.5	2.495 -0.20		2.505 0.20	V %	
	LT1460ACN8-5, ACS8-5	4.99625 -0.075		5.00375 0.075	V %	
	LT1460BIN8-5, BIS8-5, CCMS8-5, DCN8-5, DCS8-5	4.995 -0.10		5.005 0.10	V %	
	LT1460EIN8-5, EIS8-5	4.99375 -0.125		5.00625 0.125	V %	
	LT1460FCMS8-5	4.9925 -0.15		5.0075 0.15	V %	
	LT1460GCZ-5, GIZ-5	4.9875 -0.25		5.0125 0.25	V %	
	LT1460LHS8-5, MHS8-5	4.990 -0.20		5.010 0.20	V %	
	LT1460ACN8-10, ACS8-10	9.9925 -0.075		10.0075 0.075	V %	
	LT1460BIN8-10, BIS8-10, CCMS8-10, DCN8-10, DCS8-10	9.990 -0.10		10.010 0.10	V %	
	LT1460EIN8-10, EIS8-10	9.9875 -0.125		10.0125 0.125	V %	
	LT1460FCMS8-10	9.985 -0.15		10.0015 0.15	V %	
	LT1460GCZ-10, GIZ-10	9.975 -0.25		10.025 0.25	V %	
	LT1460HC		-0.2		0.2	%
	LT1460JC		-0.4		0.4	%
	LT1460KC		-0.5		0.5	%
Output Voltage Temperature Coefficient (Note 3)	$T_{MIN} \leq T_J \leq T_{MAX}$					
	LT1460ACN8, ACS8, BIN8, BIS8	●	5	10	ppm/°C	
	LT1460CCMS8	●	7	15	ppm/°C	
	LT1460DCN8, DCS8, EIN8, EIS8	●	10	20	ppm/°C	
	LT1460FCMS8, GCZ, GIZ	●	12	25	ppm/°C	
	LT1460LHS8 -40°C to 85°C	●	10	20	ppm/°C	
	-40°C to 125°C	●	25	50	ppm/°C	
	LT1460MHS8 -40°C to 125°C	●	25	50	ppm/°C	
	LT1460HC	●	10	20	ppm/°C	
	LT1460JC	●	10	20	ppm/°C	
LT1460KC	●	25	50	ppm/°C		

## ELECTRICAL CHARACTERISTICS

The ● denotes the specifications which apply over the full operating temperature range, otherwise specifications are at  $T_A = 25^\circ\text{C}$ .  $V_{IN} = V_{OUT} + 2.5\text{V}$ ,  $I_{OUT} = 0$  unless otherwise specified.

PARAMETER	CONDITIONS	MIN	TYP	MAX	UNITS
Line Regulation LT1460A, LT1460B, LT1460C, LT1460D, LT1460E, LT1460F, LT1460G, LT1460H, LT1460L, LT1460M  LT1460HC, LT1460JC, LT1460KC	$V_{OUT} + 0.9\text{V} \leq V_{IN} \leq V_{OUT} + 2.5\text{V}$	●	30	60 80	ppm/V ppm/V
	$V_{OUT} + 2.5\text{V} \leq V_{IN} \leq 20\text{V}$	●	10	25 35	ppm/V ppm/V
	$V_{OUT} + 0.9\text{V} \leq V_{IN} \leq V_{OUT} + 2.5\text{V}$	●	150	800 1000	ppm/V ppm/V
	$V_{OUT} + 2.5\text{V} \leq V_{IN} \leq 20\text{V}$	●	50	100 130	ppm/V ppm/V
Load Regulation Sourcing (Note 4) LT1460A, LT1460B, LT1460C, LT1460D, LT1460E, LT1460F, LT1460G, LT1460H, LT1460L, LT1460M  LT1460HC, LT1460JC, LT1460KC	$I_{OUT} = 100\mu\text{A}$	●	1500	2800 3500	ppm/mA ppm/mA
	$I_{OUT} = 10\text{mA}$	●	80	135 180	ppm/mA ppm/mA
	$I_{OUT} = 20\text{mA}$ $0^\circ\text{C}$ to $70^\circ\text{C}$	●	70	100 140	ppm/mA ppm/mA
	$I_{OUT} = 100\mu\text{A}$	●	1000	3000 4000	ppm/mA ppm/mA
	$I_{OUT} = 10\text{mA}$	●	50	200 300	ppm/mA ppm/mA
	$I_{OUT} = 20\text{mA}$	●	20	70 100	ppm/mA ppm/mA
Thermal Regulation (Note 5) LT1460A, LT1460B, LT1460C, LT1460D, LT1460E, LT1460F, LT1460G, LT1460H, LT1460L, LT1460M  LT1460HC, LT1460JC, LT1460KC	$\Delta P = 200\text{mW}$		0.5	2.5	ppm/mW
	$\Delta P = 200\text{mW}$		2.5	10	ppm/mW
Dropout Voltage (Note 6)	$V_{IN} - V_{OUT}$ , $I_{OUT} = 0$	●		0.9	V
	$V_{IN} - V_{OUT}$ , $I_{OUT} = 10\text{mA}$	●		1.3 1.4	V V
Output Current	Short $V_{OUT}$ to GND		40		mA
Reverse Leakage	$V_{IN} = -15\text{V}$	●	0.5	10	$\mu\text{A}$
Supply Current	LT1460-2.5	●	100	130 165	$\mu\text{A}$ $\mu\text{A}$
	LT1460-5	●	125	175 225	$\mu\text{A}$ $\mu\text{A}$
	LT1460-10	●	190	270 360	$\mu\text{A}$ $\mu\text{A}$
	LT1460S3-2.5	●	115	145 175	$\mu\text{A}$ $\mu\text{A}$
	LT1460S3-3	●	145	180 220	$\mu\text{A}$ $\mu\text{A}$
	LT1460S3-3.3	●	145	180 220	$\mu\text{A}$ $\mu\text{A}$
	LT1460S3-5	●	160	200 240	$\mu\text{A}$ $\mu\text{A}$
	LT1460S3-10	●	215	270 350	$\mu\text{A}$ $\mu\text{A}$

**ELECTRICAL CHARACTERISTICS** The ● denotes the specifications which apply over the full operating temperature range, otherwise specifications are at T<sub>A</sub> = 25°C. V<sub>IN</sub> = V<sub>OUT</sub> + 2.5V, I<sub>OUT</sub> = 0 unless otherwise specified.

PARAMETER	CONDITIONS		MIN	TYP	MAX	UNITS
Output Voltage Noise (Note 7) LT1460A, LT1460B, LT1460C, LT1460D, LT1460E, LT1460F, LT1460G, LT1460H, LT1460L, LT1460M	LT1460-2.5	0.1Hz ≤ f ≤ 10Hz		10		μV <sub>P-P</sub>
		10Hz ≤ f ≤ 1kHz		10		μV <sub>RMS</sub>
	LT1460-5	0.1Hz ≤ f ≤ 10Hz 10Hz ≤ f ≤ 1kHz		20 20		μV <sub>P-P</sub> μV <sub>RMS</sub>
LT1460HC, LT1460JC, LT1460KC	0.1Hz ≤ f ≤ 10Hz 10Hz ≤ f ≤ 1kHz			40 35		μV <sub>P-P</sub> μV <sub>RMS</sub>
				4 4		ppm (P-P) ppm (RMS)
Long-Term Stability of Output Voltage (Note 8) S8 Pkg LT1460HC, LT1460JC, LT1460KC				40		ppm/√kHr
				100		ppm/√kHr
Hysteresis (Note 9) LT1460A, LT1460B, LT1460C, LT1460D, LT1460E, LT1460F, LT1460G, LT1460H, LT1460L, LT1460M LT1460HC, LT1460JC, LT1460KC	ΔT = 0°C to 70°C ΔT = -40°C to 85°C			25 160		ppm ppm
				50 250		ppm ppm
			● ●			

**Note 1:** Stresses beyond those listed under Absolute Maximum Ratings may cause permanent damage to the device. Exposure to any Absolute Maximum Rating condition for extended periods may affect device reliability and lifetime.

**Note 2:** If the part is stored outside of the specified temperature range, the output may shift due to hysteresis.

**Note 3:** Temperature coefficient is measured by dividing the change in output voltage by the specified temperature range. Incremental slope is also measured at 25°C.

**Note 4:** Load regulation is measured on a pulse basis from no load to the specified load current. Output changes due to die temperature change must be taken into account separately.

**Note 5:** Thermal regulation is caused by die temperature gradients created by load current or input voltage changes. This effect must be added to normal line or load regulation. This parameter is not 100% tested.

**Note 6:** Excludes load regulation errors. For LT1460S3, ΔV<sub>OUT</sub> ≤ 0.2%. For all other packages, ΔV<sub>OUT</sub> ≤ 0.1%.

**Note 7:** Peak-to-peak noise is measured with a single highpass filter at 0.1Hz and 2-pole lowpass filter at 10Hz. The unit is enclosed in a still-air environment to eliminate thermocouple effects on the leads. The test time is 10 sec. RMS noise is measured with a single highpass filter at 10Hz and

a 2-pole lowpass filter at 1kHz. The resulting output is full wave rectified and then integrated for a fixed period, making the final reading an average as opposed to RMS. A correction factor of 1.1 is used to convert from average to RMS and a second correction of 0.88 is used to correct for the nonideal pass band of the filters.

**Note 8:** Long-term stability typically has a logarithmic characteristic and therefore, changes after 1000 hours tend to be much smaller than before that time. Total drift in the second thousand hours is normally less than one third that of the first thousand hours with a continuing trend toward reduced drift with time. Significant improvement in long-term drift can be realized by preconditioning the IC with a 100 hour to 200 hour, 125°C burn-in. Long-term stability will also be affected by differential stresses between the IC and the board material created during board assembly. See PC Board Layout in the Applications Information section.

**Note 9:** Hysteresis in output voltage is created by package stress that differs depending on whether the IC was previously at a higher or lower temperature. Output voltage is always measured at 25°C, but the IC is cycled to 85°C or -40°C before successive measurements. Hysteresis is roughly proportional to the square of the temperature change. For instruments that are stored at reasonably well-controlled temperatures (within 20 or 30 degrees of operating temperature) hysteresis is generally not a problem.

## TYPICAL PERFORMANCE CHARACTERISTICS

LT1460-2.5 (N8, S8, MS8, Z Packages)

**2.5V Minimum Input-Output Voltage Differential**

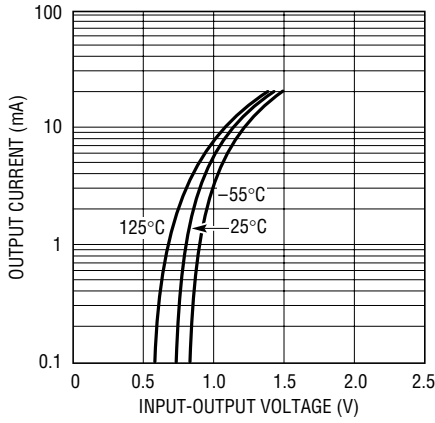

**2.5V Load Regulation, Sourcing**

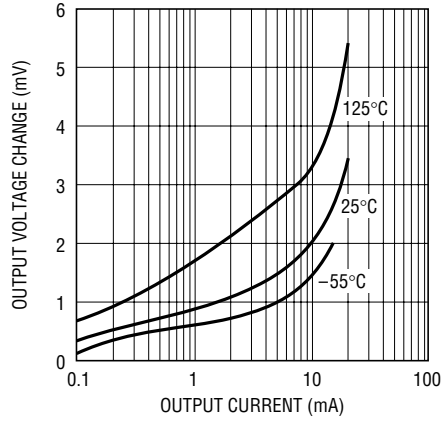

**2.5V Load Regulation, Sinking**

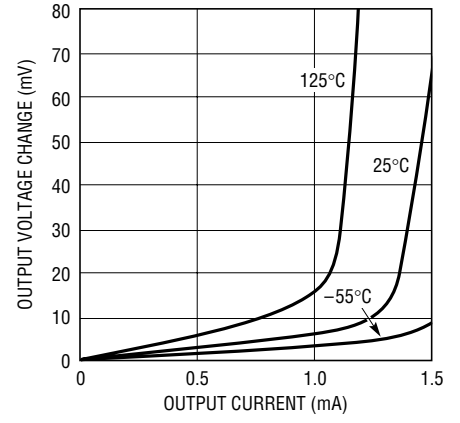

**2.5V Output Voltage Temperature Drift**

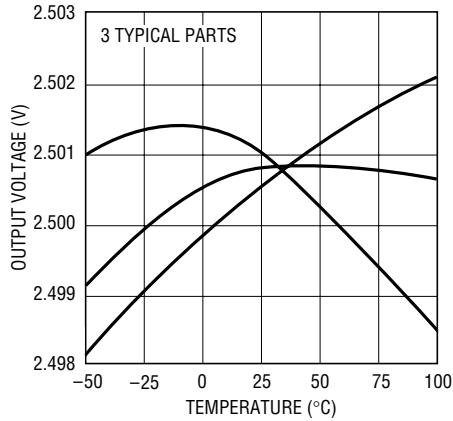

**2.5V Supply Current vs Input Voltage**

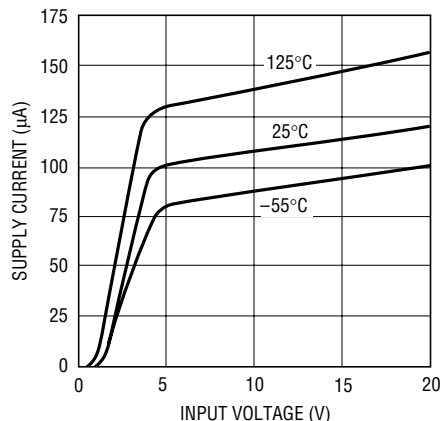

**2.5V Line Regulation**

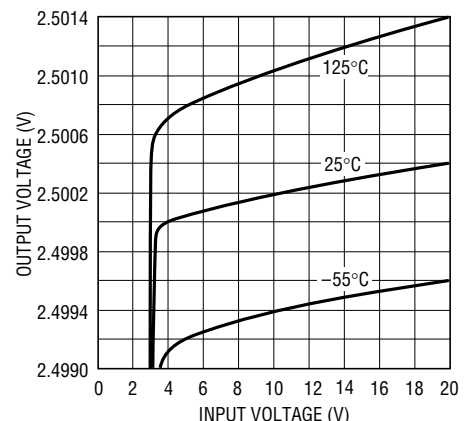

**2.5V Power Supply Rejection Ratio vs Frequency**

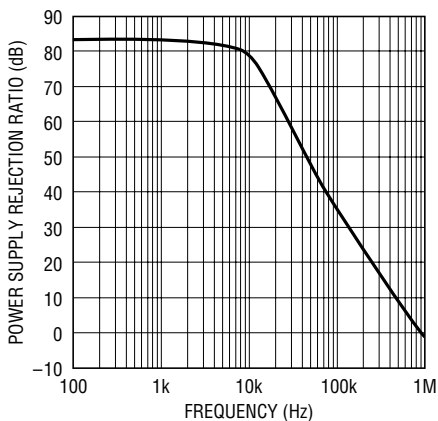

**2.5V Output Impedance vs Frequency**

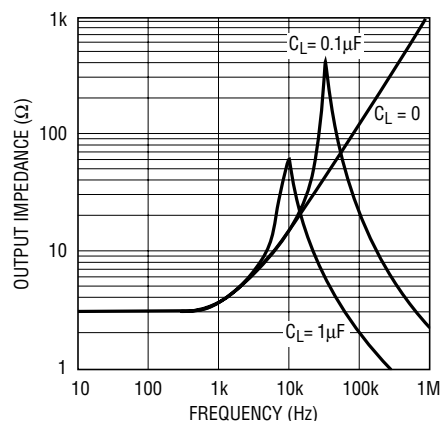

**2.5V Transient Responses**

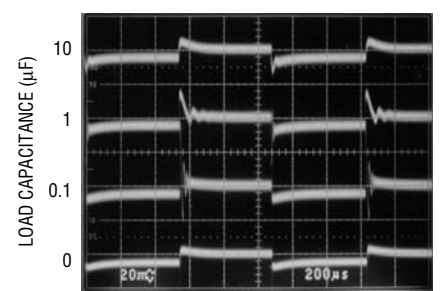



# TYPICAL PERFORMANCE CHARACTERISTICS

**2.5V Output Voltage Noise Spectrum**

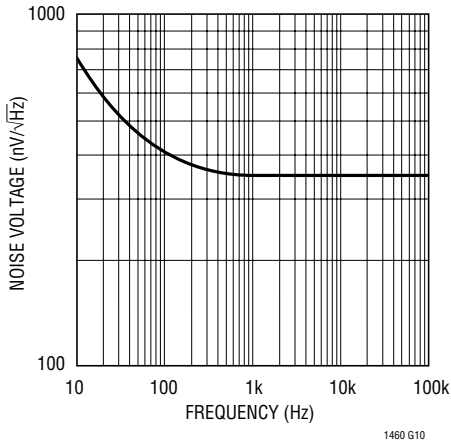

1460 G10

**2.5V Output Noise 0.1Hz to 10Hz**

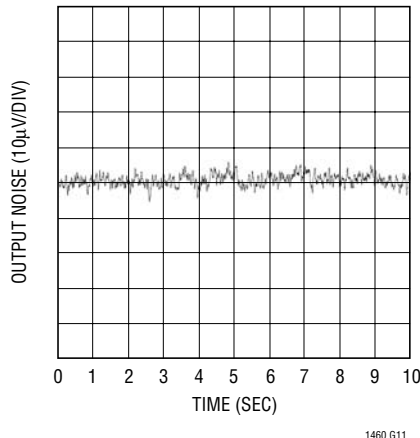

1460 G11

**2.5V Long-Term Drift Three Typical Parts (S8 Package)**

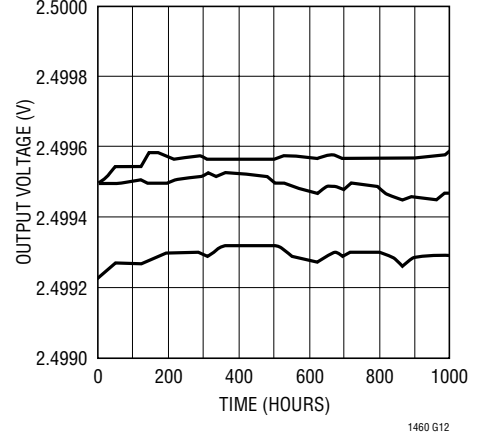

1460 G12

## LT1460-5 (N8, S8, MS8, Z Packages)

**5V Minimum Input-Output Voltage Differential**

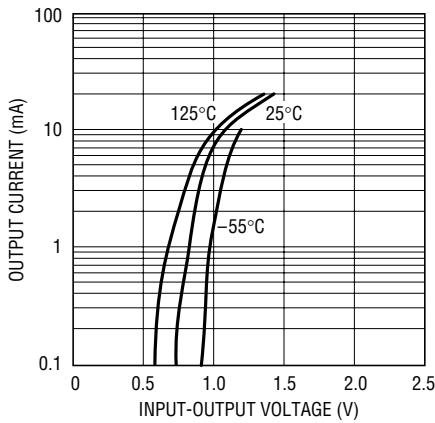

1460 G13

**5V Load Regulation, Sourcing**

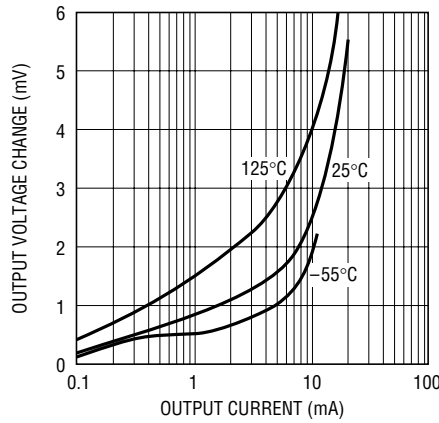

1460 G14

**5V Load Regulation, Sinking**

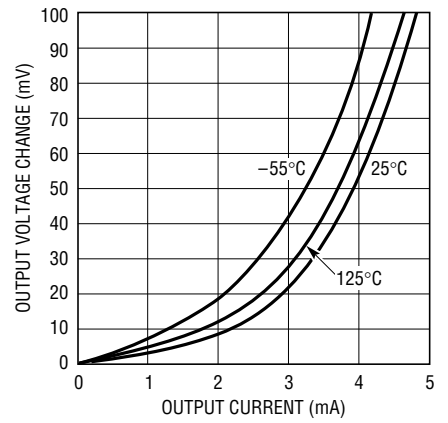

1460 G15

**5V Output Voltage Temperature Drift**

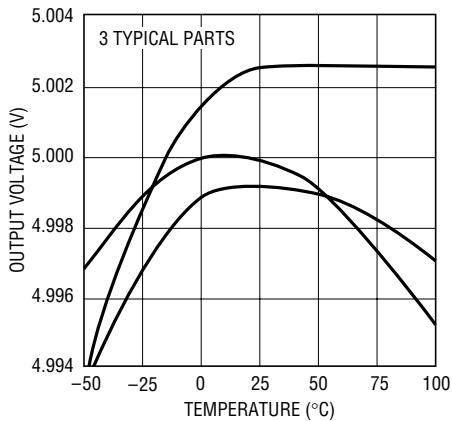

1460 G16

**5V Supply Current vs Input Voltage**

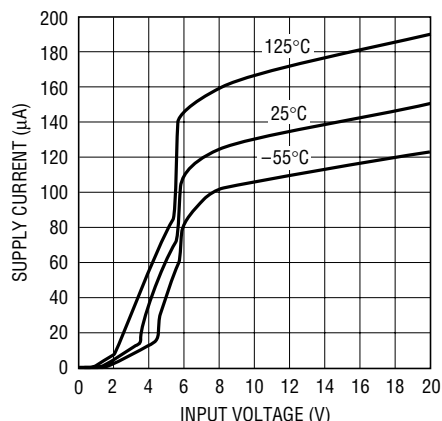

1460 G17

**5V Line Regulation**

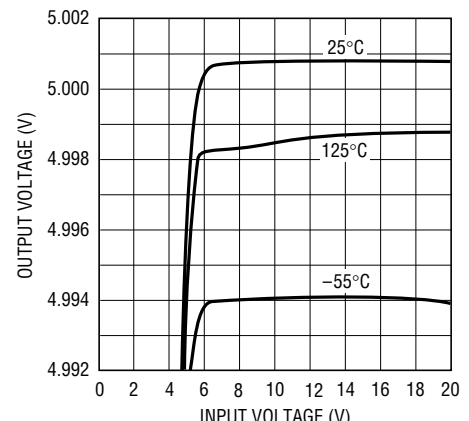

1460 G18

1460f

## TYPICAL PERFORMANCE CHARACTERISTICS

LT1460-5 (N8, S8, MS8, Z Packages)

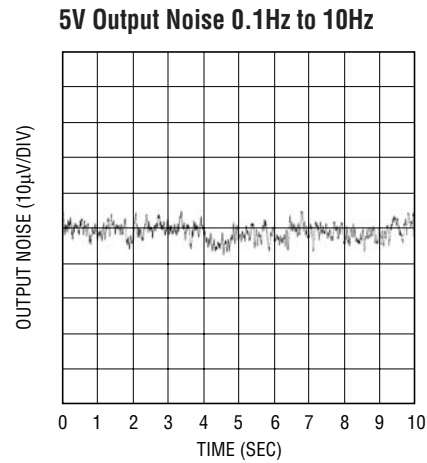
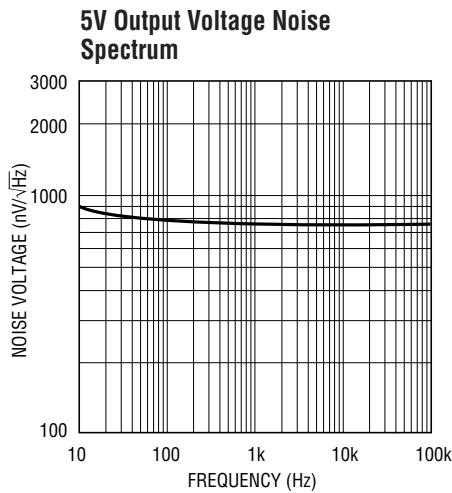
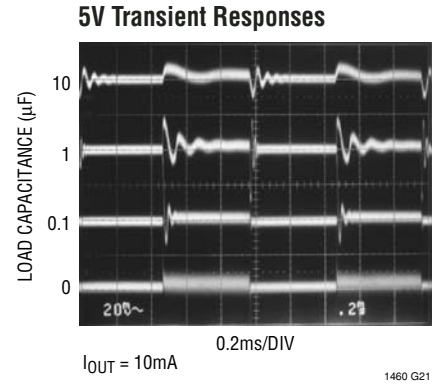
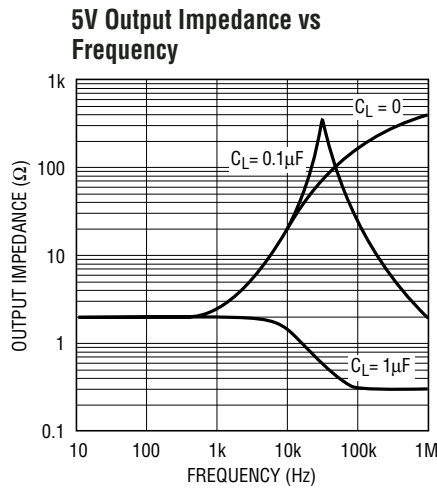
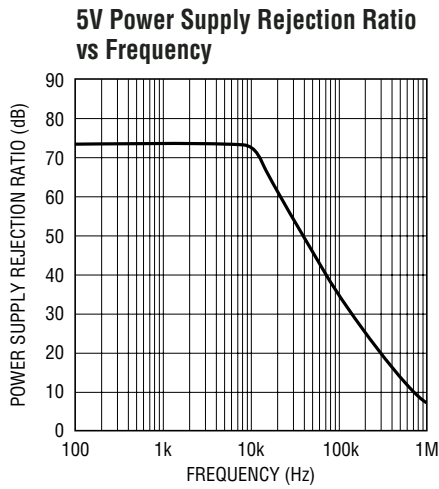

LT1460-10 (N8, S8, MS8, Z Packages)

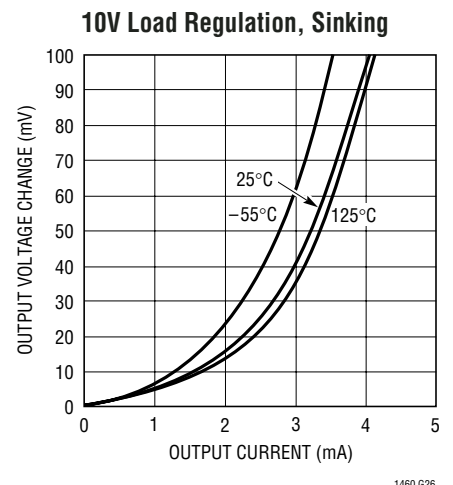
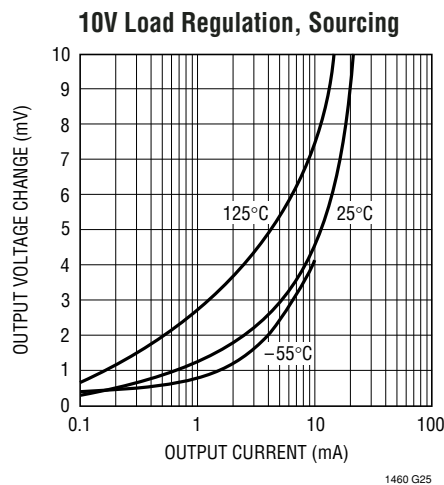
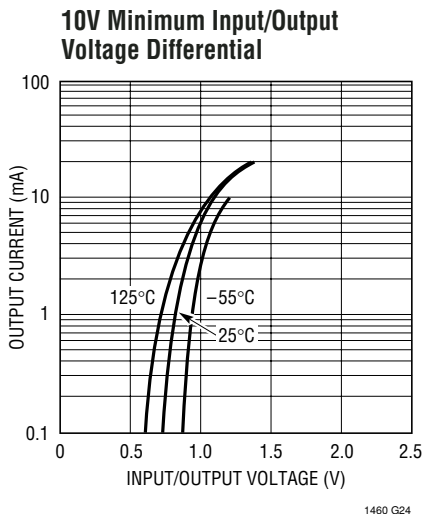

# TYPICAL PERFORMANCE CHARACTERISTICS

**10V Output Voltage Temperature Drift**

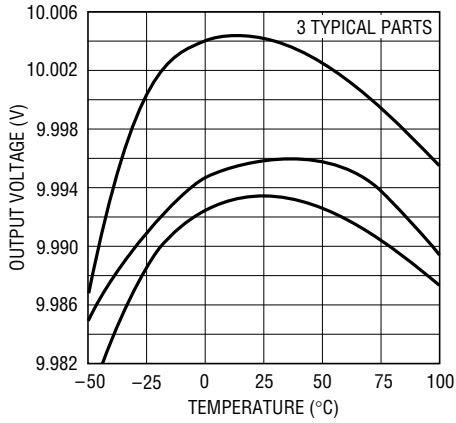

1460 G27

**10V Supply Current vs Input Voltage**

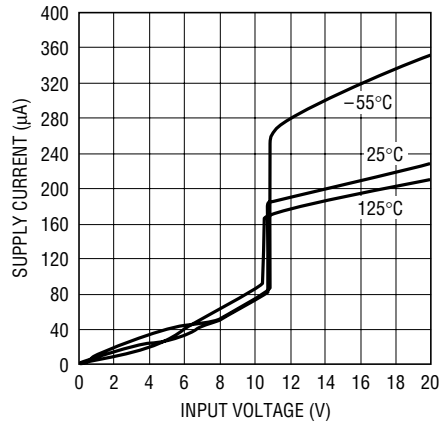

1460 G28

**10V Line Regulation**

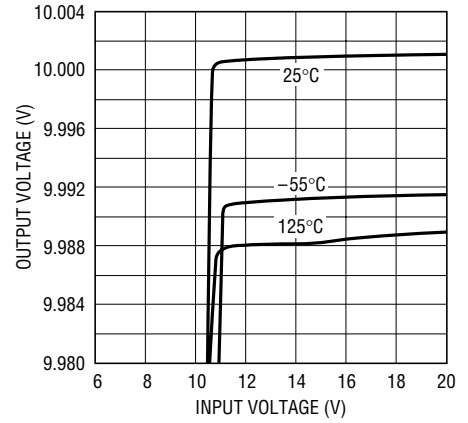

1460 G29

**10V Power Supply Rejection Ratio vs Frequency**

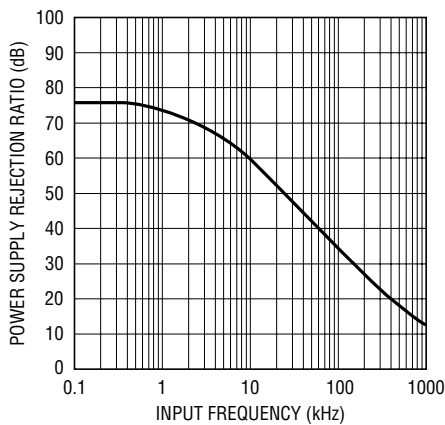

1460 G30

**10V Output Impedance vs Frequency**

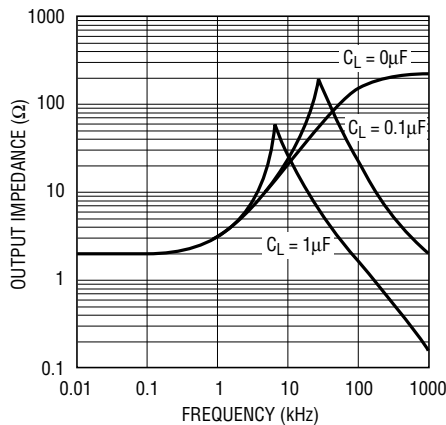

1460 G31

**10V Transient Responses**

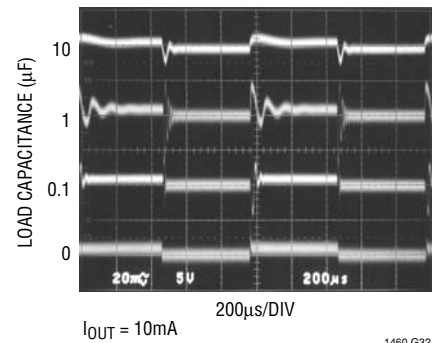

1460 G32

**10V Output Voltage Noise Spectrum**

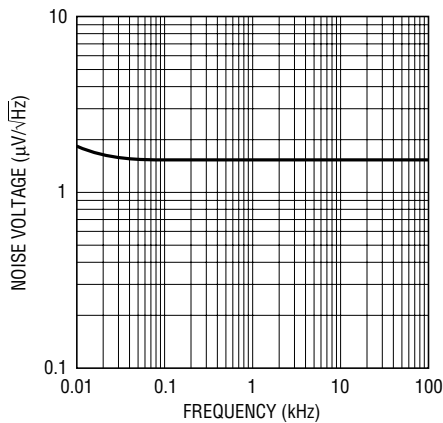

1460 G33

**10V Output Noise 0.1Hz to 10Hz**

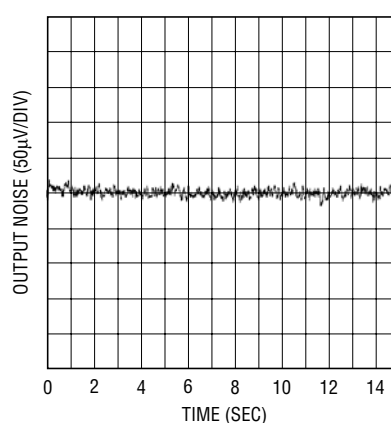

1460 G34

## TYPICAL PERFORMANCE CHARACTERISTICS

Characteristic curves are similar for all voltage options of the LT1460S3. Curves from the LT1460S3-2.5 and the LT1460S3-10 represent the extremes of the voltage options. Characteristic curves for other output voltages fall between these curves, and can be estimated based on their voltage output.

**LT1460S3-2.5V Minimum Input-Output Voltage Differential**

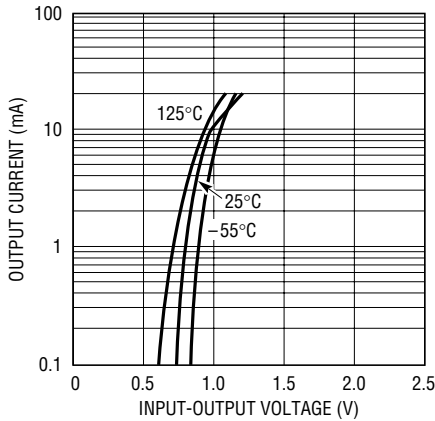

1460 G35

**LT1460S3-2.5V Load Regulation, Sourcing**

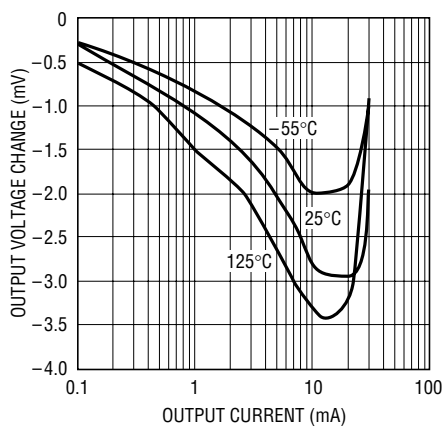

1460 G36

**LT1460S3-2.5V Load Regulation, Sinking**

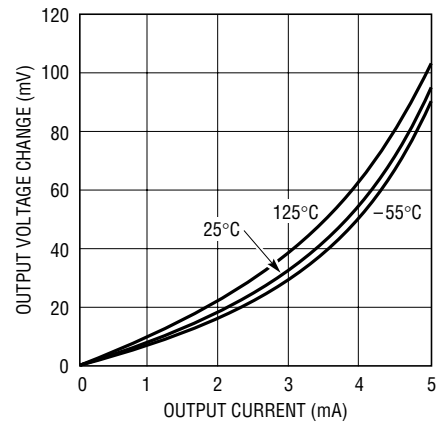

1460 G37

**LT1460S3-2.5V Output Voltage Temperature Drift**

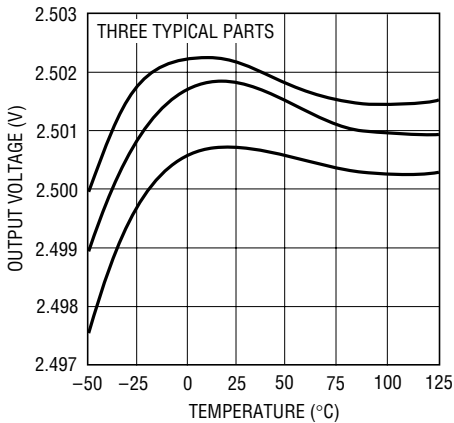

1460 G38

**LT1460S3-2.5V Supply Current vs Input Voltage**

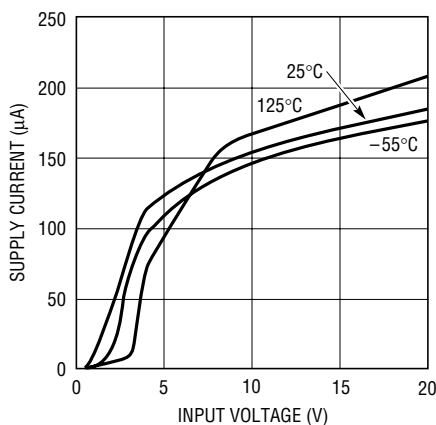

1460 G39

**LT1460S3-2.5V Line Regulation**

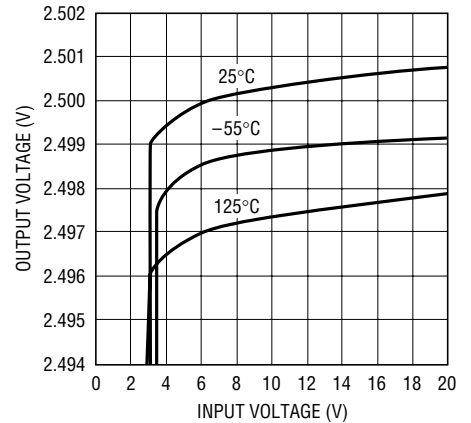

1460 G40

**LT1460S3-2.5V Power Supply Rejection Ratio vs Frequency**

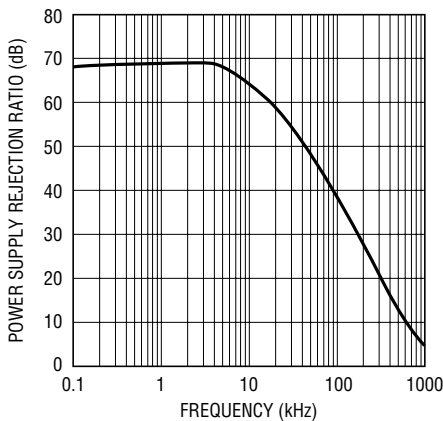

1460 G41

**LT1460S3-2.5V Output Impedance vs Frequency**

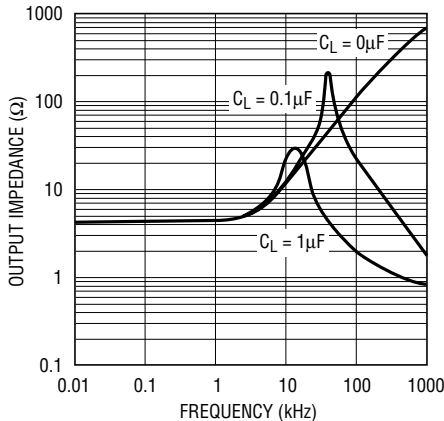

1460 G42

**LT1460S3-2.5V Transient Response**

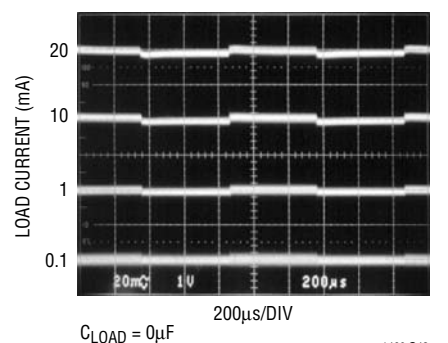

1460 G43

**TYPICAL PERFORMANCE CHARACTERISTICS** Characteristic curves are similar for all voltage options of the LT1460S3. Curves from the LT1460S3-2.5 and the LT1460S3-10 represent the extremes of the voltage options. Characteristic curves for other output voltages fall between these curves, and can be estimated based on their voltage output.

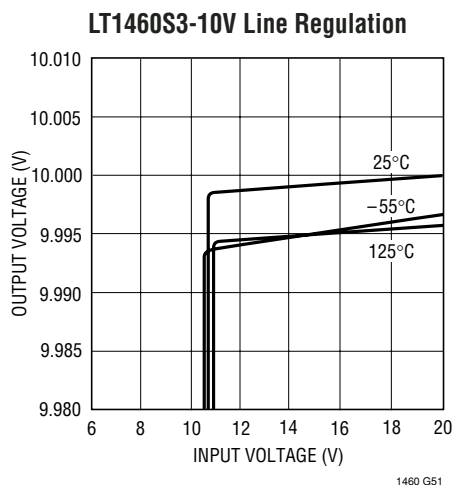
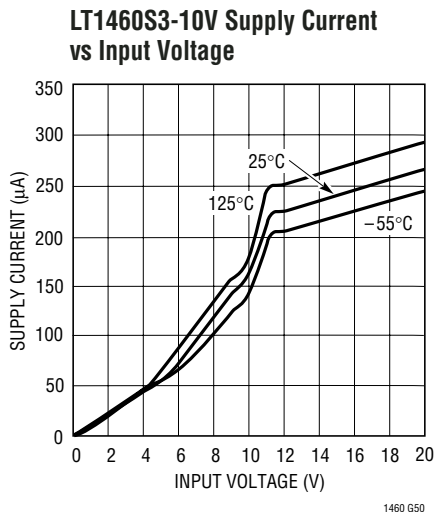
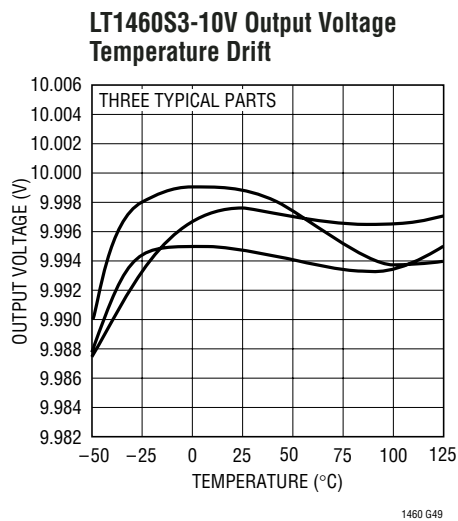
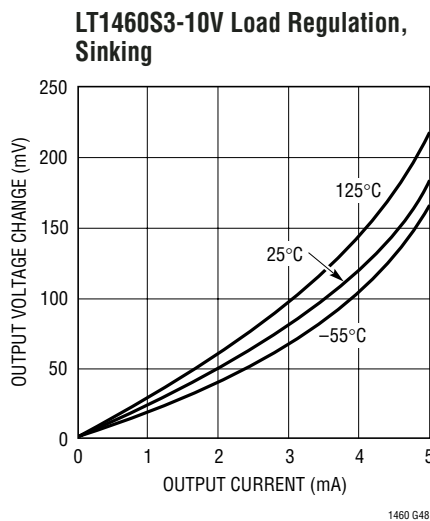
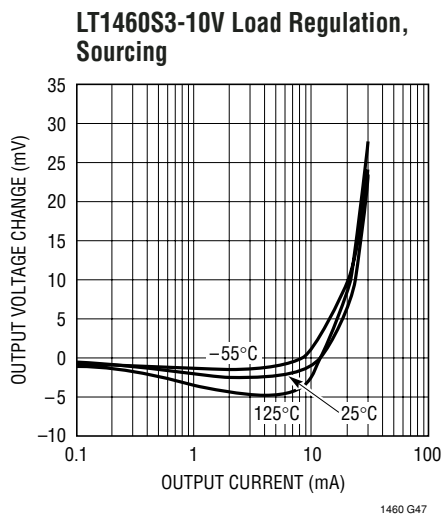
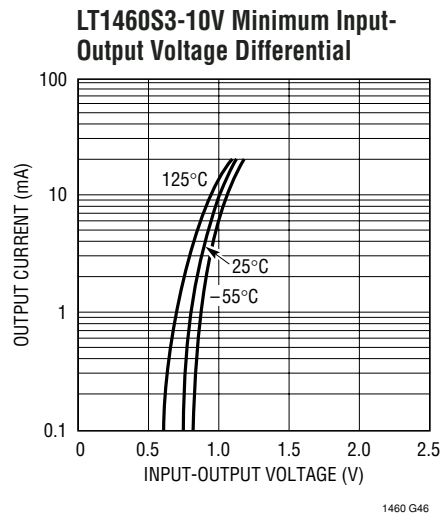
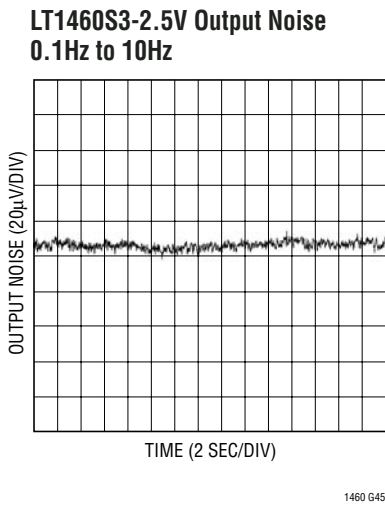
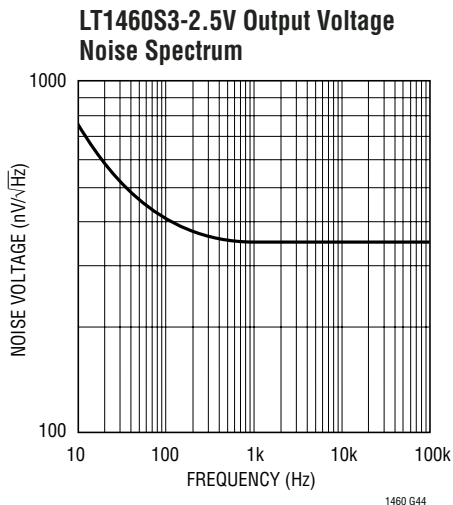

**TYPICAL PERFORMANCE CHARACTERISTICS** Characteristic curves are similar for all voltage options of the LT1460S3. Curves from the LT1460S3-2.5 and the LT1460S3-10 represent the extremes of the voltage options. Characteristic curves for other output voltages fall between these curves, and can be estimated based on their voltage output.

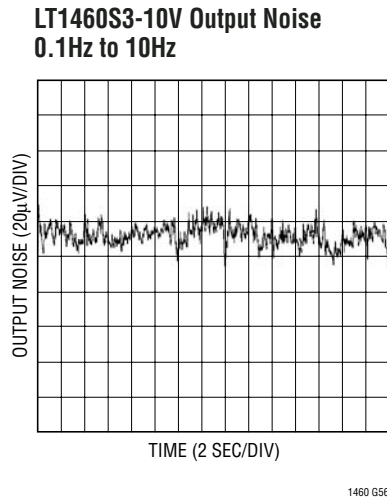
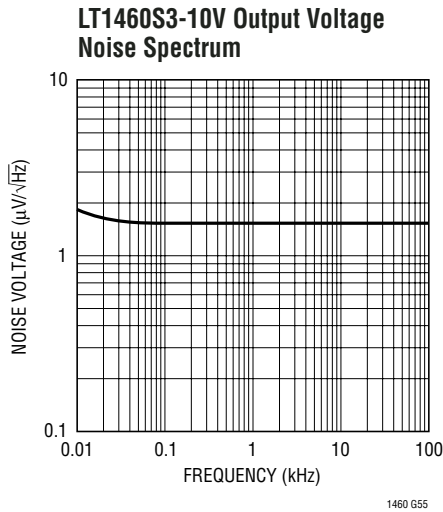
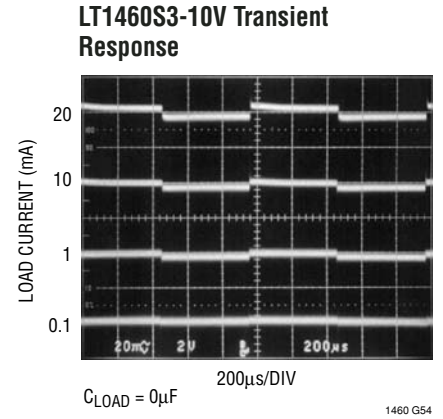
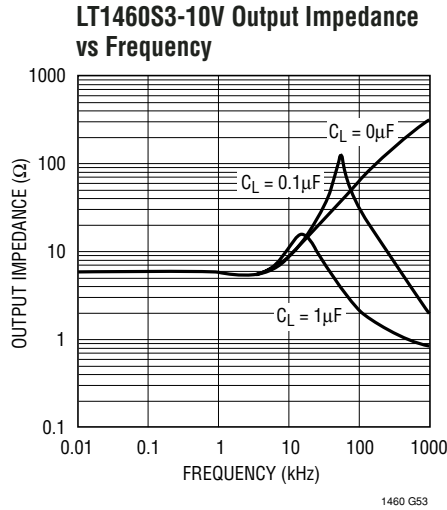
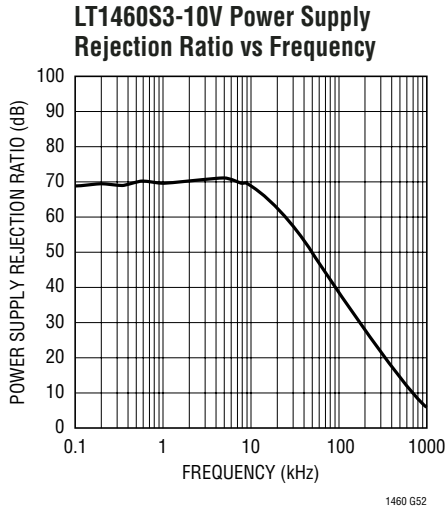

## APPLICATIONS INFORMATION

### Longer Battery Life

Series references have a large advantage over older shunt style references. Shunt references require a resistor from the power supply to operate. This resistor must be chosen to supply the maximum current that can ever be demanded by the circuit being regulated. When the circuit being controlled is not operating at this maximum current, the shunt reference must always sink this current, resulting in high dissipation and short battery life.

The LT1460 series reference does not require a current setting resistor and can operate with any supply voltage from  $V_{OUT} + 0.9V$  to  $20V$ . When the circuitry being regulated does not demand current, the LT1460 reduces its dissipation and battery life is extended. If the reference is not delivering load current it dissipates only a few mW, yet the same configuration can deliver 20mA of load current when demanded.

### Capacitive Loads

The LT1460 is designed to be stable with capacitive loads. With no capacitive load, the reference is ideal for fast settling, applications where PC board space is a premium, or where available capacitance is limited.

The test circuit for the LT1460-2.5 shown in Figure 1 is used to measure the response time for various load currents and load capacitors. The 1V step from 2.5V to 1.5V produces a current step of 1mA or  $100\mu A$  for  $R_L = 1k$  or  $R_L = 10k$ . Figure 2 shows the response of the reference with no load capacitance.

The reference settles to 2.5mV (0.1%) in less than  $1\mu s$  for a  $100\mu A$  pulse and to 0.1% in  $1.5\mu s$  with a 1mA step. When load capacitance is greater than  $0.01\mu F$ , the reference begins to ring due to the pole formed with the output impedance. Figure 3 shows the response of the reference to a 1mA and  $100\mu A$  load current step with a  $0.01\mu F$  load capacitor. The ringing can be greatly reduced with a DC load as small as  $200\mu A$ . With large output capacitors,  $\geq$

$1\mu F$ , the ringing can be reduced with a small resistor in series with the reference output as shown in Figure 4. Figure 5 shows the response of the LT1460-2.5 with a

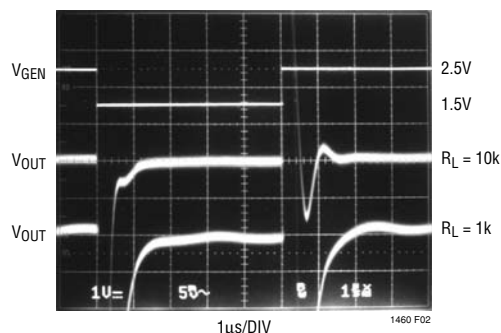

Figure 2.  $C_L = 0$

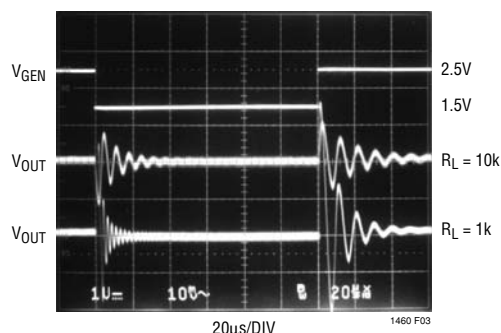

Figure 3.  $C_L = 0.01\mu F$

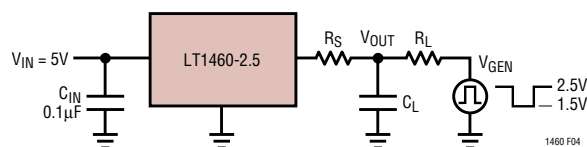

Figure 4. Isolation Resistor Test Circuit

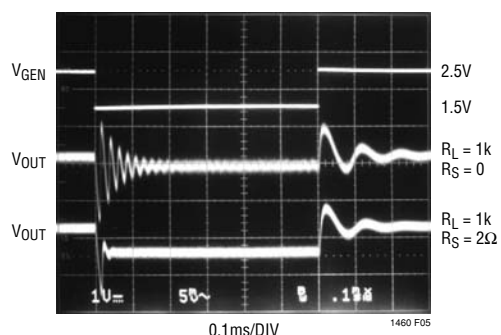

Figure 5. Effect of  $R_S$  for  $C_L = 1\mu F$

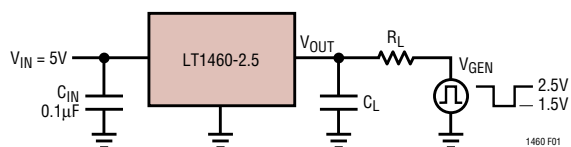

Figure 1. Response Time Test Circuit

## APPLICATIONS INFORMATION

$R_S = 2\Omega$  and  $C_L = 1\mu F$ .  $R_S$  should not be made arbitrarily large because it will limit the load regulation.

Figure 6 to Figure 8 illustrate response in the LT1460-5. The 1V step from 5V to 4V produces a current step of 1mA or 100 $\mu A$  for  $R_L = 1k$  or  $R_L = 10k$ . Figure 7 shows the response of the reference with no load capacitance.

The reference settles to 5mV (0.1%) in less than 2 $\mu s$  for a 100 $\mu A$  pulse and to 0.1% in 3 $\mu s$  with a 1mA step. When load capacitance is greater than 0.01 $\mu F$ , the reference begins to ring due to the pole formed with the output impedance. Figure 8 shows the response of the reference to a 1mA

and 100 $\mu A$  load current step with a 0.01 $\mu F$  load capacitor. Figure 9 to Figure 11 illustrate response of the LT1460-10. The 1V step from 10V to 9V produces a current step of 1mA or 100 $\mu A$  for  $R_L = 1k$  or  $R_L = 10k$ . Figure 10 shows the response of the reference with no load capacitance.

The reference settles to 10mV (0.1%) in 0.4 $\mu s$  for a 100 $\mu A$  pulse and to 0.1% in 0.8 $\mu s$  with a 1mA step. When load capacitance is greater than 0.01 $\mu F$ , the reference begins to ring due to the pole formed with the output impedance. Figure 11 shows the response of the reference to a 1mA and 100 $\mu A$  load current step with a 0.01 $\mu F$  load capacitor.

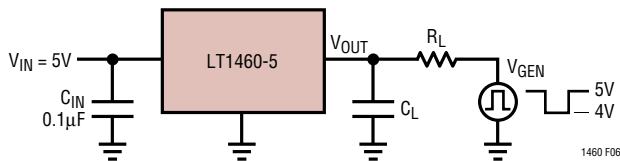

Figure 6. Response Time Test Circuit

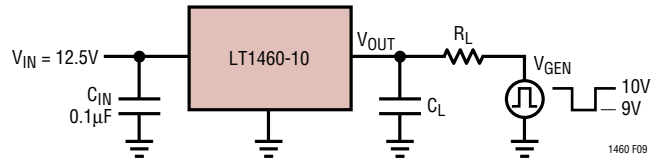

Figure 9. Response Time Test Circuit

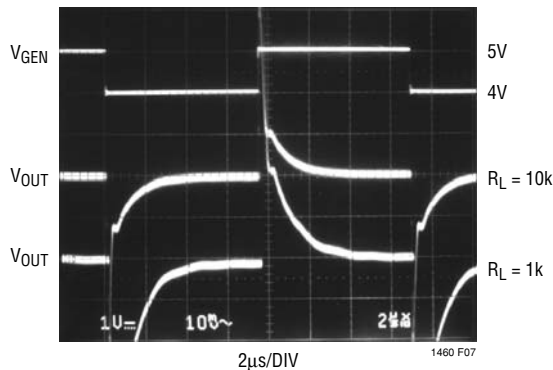

Figure 7.  $C_L = 0$

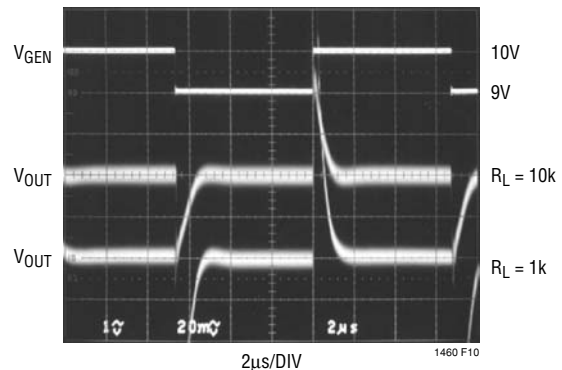

Figure 10.  $C_L = 0$

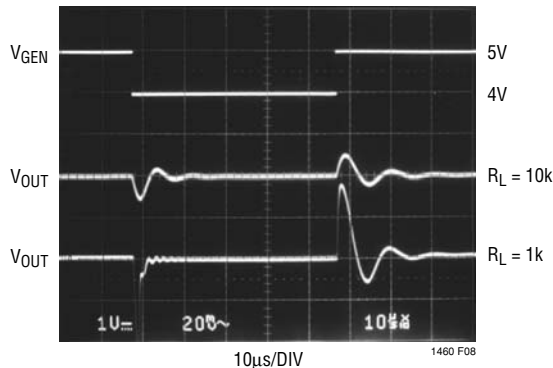

Figure 8.  $C_L = 0.01\mu F$

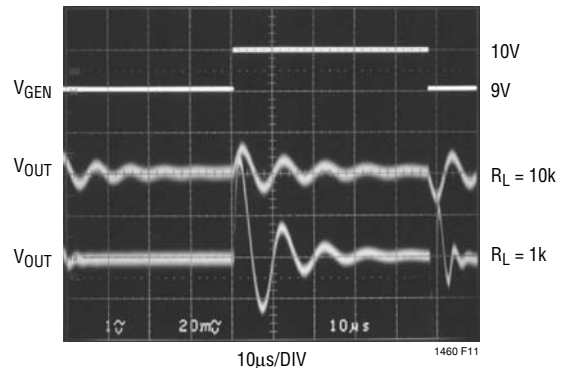

Figure 11.  $C_L = 0.01\mu F$



## APPLICATIONS INFORMATION

Table 1 gives the maximum output capacitance for various load currents and output voltages to avoid instability. Load capacitors with low ESR (effective series resistance) cause more ringing than capacitors with higher ESR such as polarized aluminum or tantalum capacitors.

**Table 1. Maximum Output Capacitance**

VOLTAGE OPTION	I <sub>OUT</sub> = 100μA	I <sub>OUT</sub> = 1mA	I <sub>OUT</sub> = 10mA	I <sub>OUT</sub> = 20mA
2.5V	>10μF	>10μF	2μF	0.68μF
3V	>10μF	>10μF	2μF	0.68μF
3.3V	>10μF	>10μF	1μF	0.68μF
5V	>10μF	>10μF	1μF	0.68μF
10V	>10μF	1μF	0.15μF	0.1μF

### Long-Term Drift

**Long-term drift cannot be extrapolated from accelerated high temperature testing. This erroneous technique gives drift numbers that are wildly optimistic. The only way long-term drift can be determined is to measure it over the time interval of interest.** The LT1460S3 long-term drift data was taken on over 100 parts that were soldered into PC boards similar to a “real world” application. The boards were then placed into a constant temperature oven with T<sub>A</sub> = 30°C, their outputs were scanned regularly and measured with an 8.5 digit DVM. Figure 12 shows typical long-term drift of the LT1460S3s.

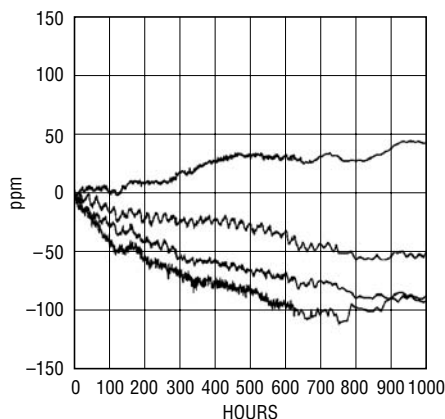

**Figure 12. Typical Long-Term Drift**

### Hysteresis

Hysteresis data shown in Figure 13 and Figure 14 represents the worst-case data taken on parts from 0°C to 70°C and from -40°C to 85°C. The device is capable of dissipating relatively high power, i.e., for the LT1460S3-2.5, PD = 17.5V • 20mA = 350mW. The thermal resistance of the SOT-23 package is 325°C/W and this dissipation causes a 114°C internal rise producing a junction temperature of T<sub>J</sub> = 25°C + 114°C = 139°C. This elevated temperature will cause the output to shift due to thermal hysteresis. **For highest performance in precision applications, do not let the LT1460S3’s junction temperature exceed 85°C.**

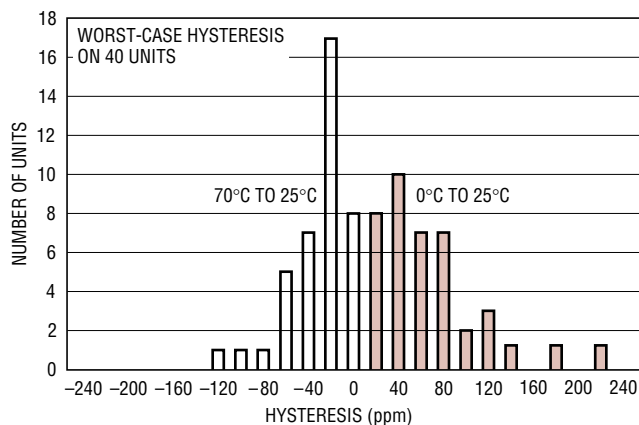

**Figure 13. 0°C to 70°C Hysteresis**

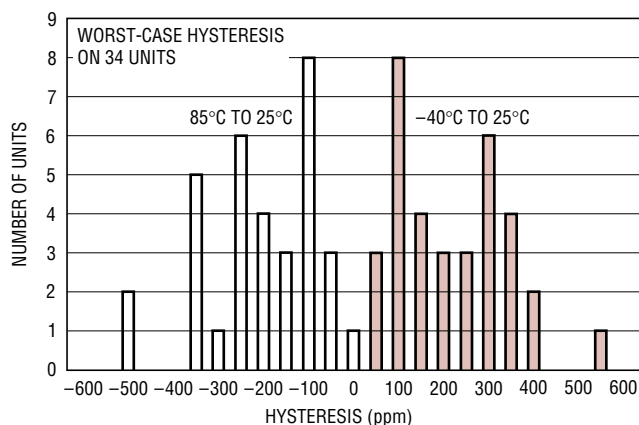

**Figure 14. -40°C to 85°C Hysteresis**

## APPLICATIONS INFORMATION

### Input Capacitance

It is recommended that a 0.1μF or larger capacitor be added to the input pin of the LT1460. This can help with stability when large load currents are demanded.

### Output Accuracy

Like all references, either series or shunt, the error budget of the LT1460-2.5 is made up of primarily three components: initial accuracy, temperature coefficient and load regulation. Line regulation is neglected because it typically contributes only 30ppm/V, or 75μV for a 1V input change. The LT1460-2.5 typically shifts less than 0.01% when soldered into a PCB, so this is also neglected (see PC Board Layout section). The output errors are calculated as follows for a 100μA load and 0°C to 70°C temperature range:

#### LT1460AC

Initial accuracy = 0.075%

For  $I_O = 100\mu\text{A}$ , and using the LT1460-2.5 for calculation,

$$\Delta V_{\text{OUT}} = \left( \frac{3500\text{ppm}}{\text{mA}} \right) (0.1\text{mA})(2.5\text{V}) = 875\mu\text{V}$$

which is 0.035%.

For temperature 0°C to 70°C the maximum  $\Delta T = 70^\circ\text{C}$ ,

$$\Delta V_{\text{OUT}} = \left( \frac{10\text{ppm}}{^\circ\text{C}} \right) (70^\circ\text{C})(2.5\text{V}) = 1.75\text{mV}$$

which is 0.07%.

Total worst-case output error is:

$$0.075\% + 0.035\% + 0.070\% = 0.180\%.$$

Table 1 gives worst-case accuracy for the LT1460AC, CC, DC, FC, GC from 0°C to 70°C and the LT1460BI, EI, GI from -40°C to 85°C.

Note that the LT1460-5 and LT1460-10 give identical accuracy as a fraction of their respective output voltages.

### PC Board Layout

In 13- to 16-bit systems where initial accuracy and temperature coefficient calibrations have been done, the mechanical and thermal stress on a PC board (in a cardcage for instance) can shift the output voltage and mask the true temperature coefficient of a reference. In addition, the mechanical stress of being soldered into a PC board can cause the output voltage to shift from its ideal value. Surface mount voltage references (MS8 and S8) are the most susceptible to PC board stress because of the small amount of plastic used to hold the lead frame.

A simple way to improve the stress-related shifts is to mount the reference near the short edge of the PC board, or in a corner. The board edge acts as a stress boundary, or a region where the flexure of the board is minimum. The package should always be mounted so that the leads absorb the stress and not the package. The package is generally aligned with the leads parallel to the long side of the PC board as shown in Figure 16a.

A qualitative technique to evaluate the effect of stress on voltage references is to solder the part into a PC board and

**Table 1. Worst-Case Output Accuracy Over Temperature**

$I_{\text{OUT}}$	LT1460AC	LT1460BI	LT1460CC	LT1460DC	LT1460EI	LT1460FC	LT1460GC	LT1460GI	LT1460HC	LT1460JC	LT1460KC
0	0.145%	0.225%	0.205%	0.240%	0.375%	0.325%	0.425%	0.562%	0.340%	0.540%	0.850%
100μA	0.180%	0.260%	0.240%	0.275%	0.410%	0.360%	0.460%	0.597%	0.380%	0.580%	0.890%
10mA	0.325%	0.405%	0.385%	0.420%	0.555%	0.505%	0.605%	0.742%	0.640%	0.840%	1.15%
20mA	0.425%	N/A	0.485%	0.520%	N/A	0.605%	0.705%	N/A	0.540%	0.740%	1.05%

## APPLICATIONS INFORMATION

deform the board a fixed amount as shown in Figure 15. The flexure #1 represents no displacement, flexure #2 is concave movement, flexure #3 is relaxation to no displacement and finally, flexure #4 is a convex movement. This motion is repeated for a number of cycles and the relative output deviation is noted. The result shown in Figure 16a is for two LT1460S8-2.5s mounted vertically and Figure 16b is for two LT1460S8-2.5s mounted horizontally. The parts oriented in Figure 16a impart less stress into the package because stress is absorbed in the leads. Figures 16a and 16b show the deviation to be between 125 $\mu$ V and

250 $\mu$ V and implies a 50ppm and 100ppm change respectively. This corresponds to a 13- to 14-bit system and is not a problem for most 10- to 12-bit systems unless the system has a calibration. In this case, as with temperature hysteresis, this low level can be important and even more careful techniques are required.

The most effective technique to improve PC board stress is to cut slots in the board around the reference to serve as a strain relief. These slots can be cut on three sides of the reference and the leads can exit on the fourth side. This “tongue” of PC board material can be oriented in the long direction of the board to further reduce stress transferred to the reference.

The results of slotting the PC boards of Figures 16a and 16b are shown in Figures 17a and 17b. In this example the slots can improve the output shift from about 100ppm to nearly zero.

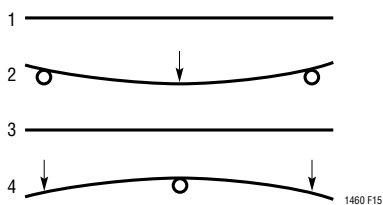

Figure 15. Flexure Numbers

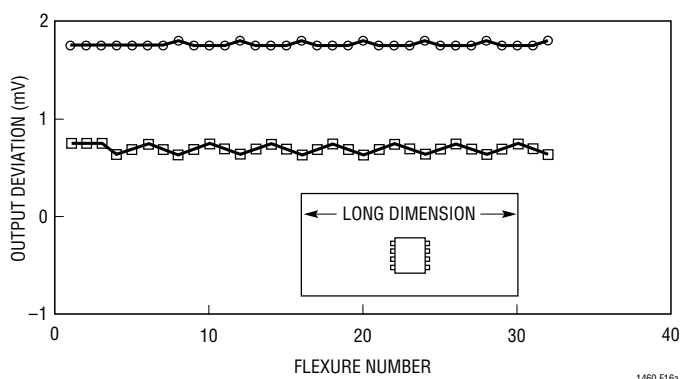

Figure 16a. Two Typical LT1460S8-2.5s, Vertical Orientation Without Slots

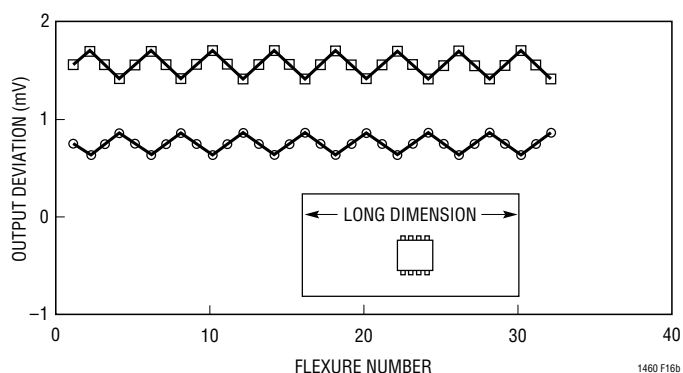

Figure 16b. Two Typical LT1460S8-2.5s, Horizontal Orientation Without Slots

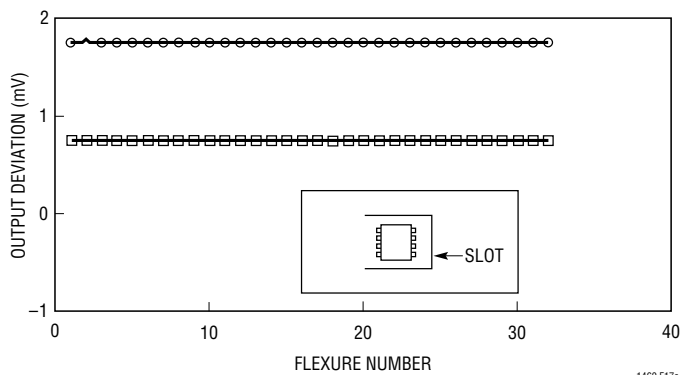

Figure 17a. Same Two LT1460S8-2.5s in Figure 16a, but with Slots

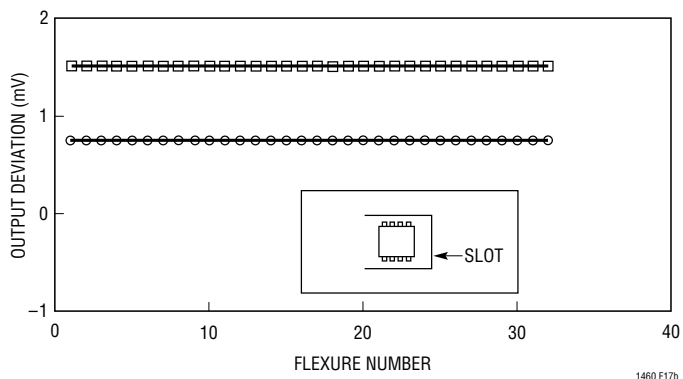
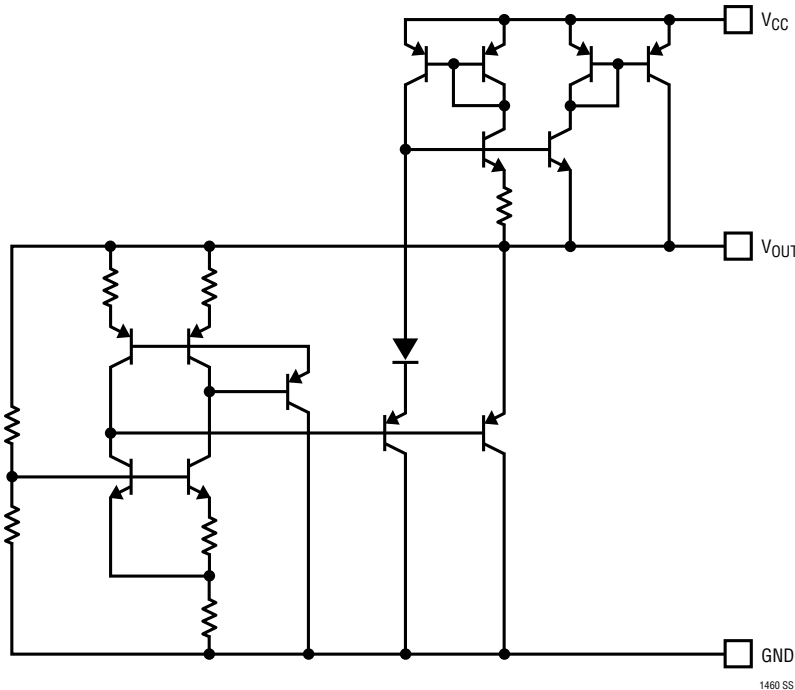

Figure 17b. Same Two LT1460S8-2.5s in Figure 16b, but with Slots

**SIMPLIFIED SCHEMATIC**



1460 SS

# PACKAGE DESCRIPTION

## S3 Package 3-Lead Plastic SOT-23 (Reference LTC DWG # 05-08-1631)

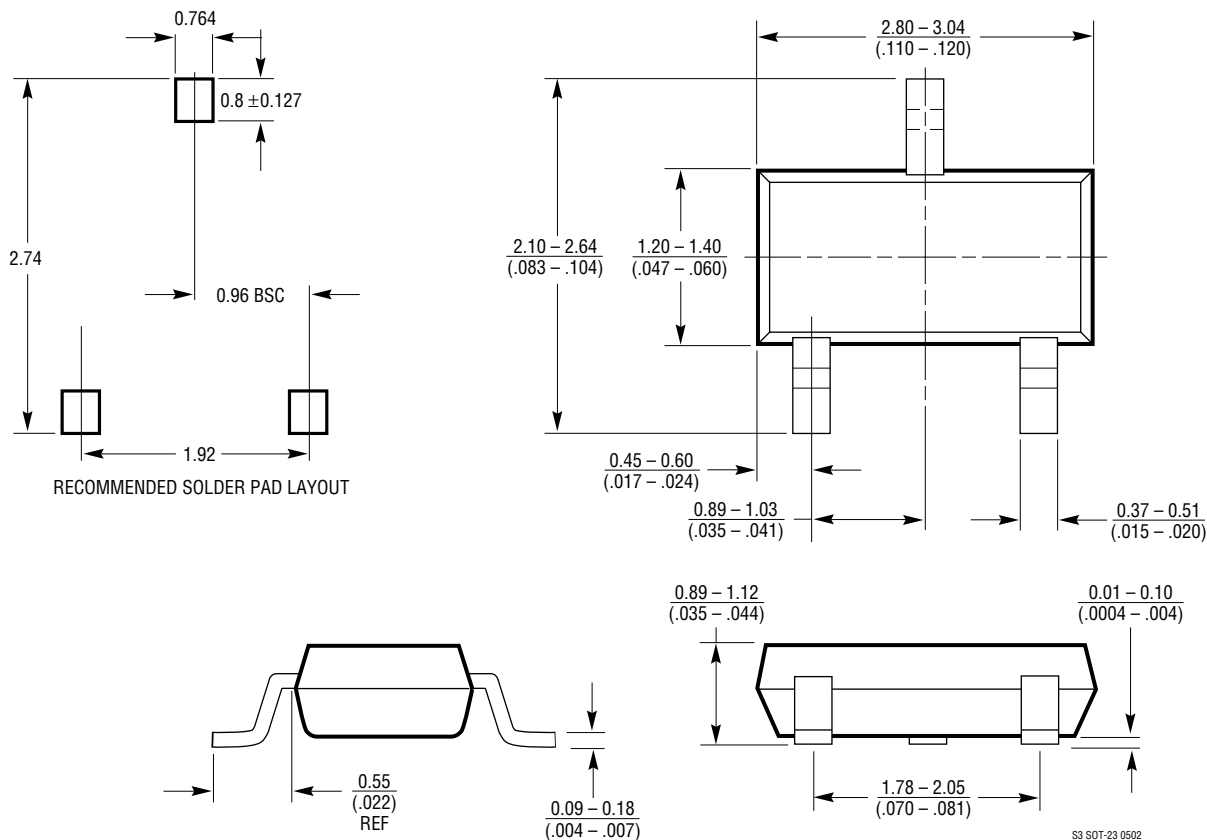

- NOTE:
1. CONTROLLING DIMENSION: MILLIMETERS
  2. DIMENSIONS ARE IN MILLIMETERS (INCHES)
  3. DRAWING NOT TO SCALE
  4. DIMENSIONS ARE INCLUSIVE OF PLATING
  5. DIMENSIONS ARE EXCLUSIVE OF MOLD FLASH AND METAL BURR
  6. MOLD FLASH SHALL NOT EXCEED .254mm
  7. PACKAGE JEDEC REFERENCE IS TO-236 VARIATION AB

S3 SOT-23 0502

**PACKAGE DESCRIPTION**

**N8 Package**  
**8-Lead PDIP (Narrow .300 Inch)**  
 (Reference LTC DWG # 05-08-1510)

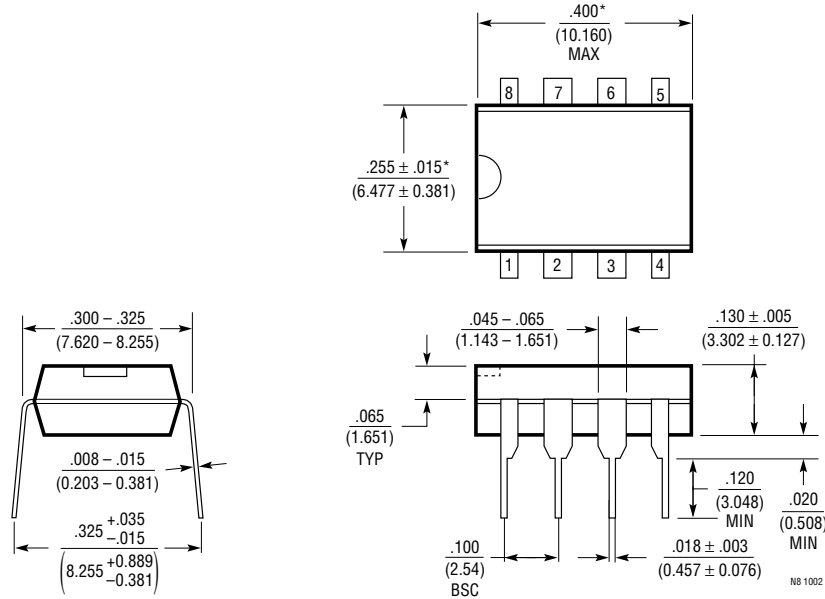

NOTE:  
 1. DIMENSIONS ARE  $\frac{\text{INCHES}}{\text{MILLIMETERS}}$   
 \*THESE DIMENSIONS DO NOT INCLUDE MOLD FLASH OR PROTRUSIONS.  
 MOLD FLASH OR PROTRUSIONS SHALL NOT EXCEED .010 INCH (0.254mm)

**S8 Package**  
**8-Lead Plastic Small Outline (Narrow .150 Inch)**  
 (Reference LTC DWG # 05-08-1610)

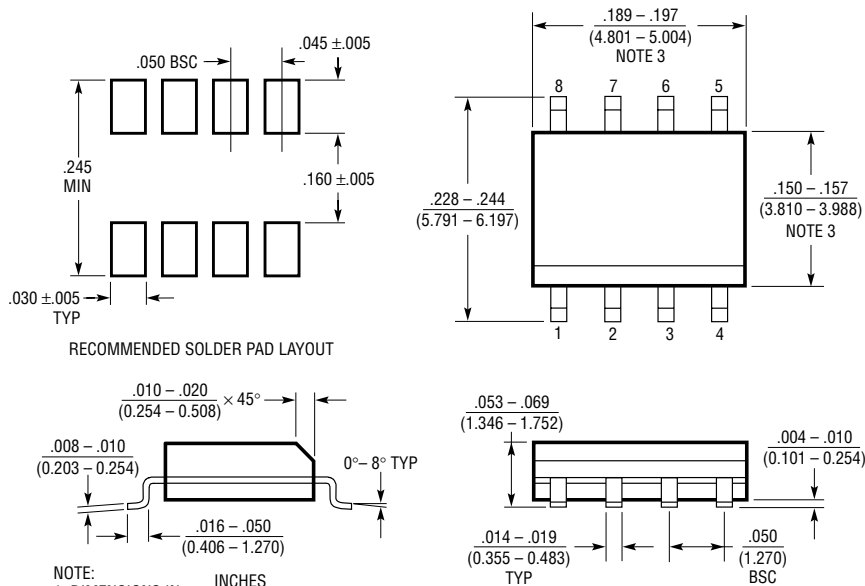

NOTE:  
 1. DIMENSIONS IN  $\frac{\text{INCHES}}{\text{MILLIMETERS}}$   
 2. DRAWING NOT TO SCALE  
 3. THESE DIMENSIONS DO NOT INCLUDE MOLD FLASH OR PROTRUSIONS.  
 MOLD FLASH OR PROTRUSIONS SHALL NOT EXCEED .006" (0.15mm)

S08 0303

# PACKAGE DESCRIPTION

## MS8 Package 8-Lead Plastic MSOP (Reference LTC DWG # 05-08-1660)

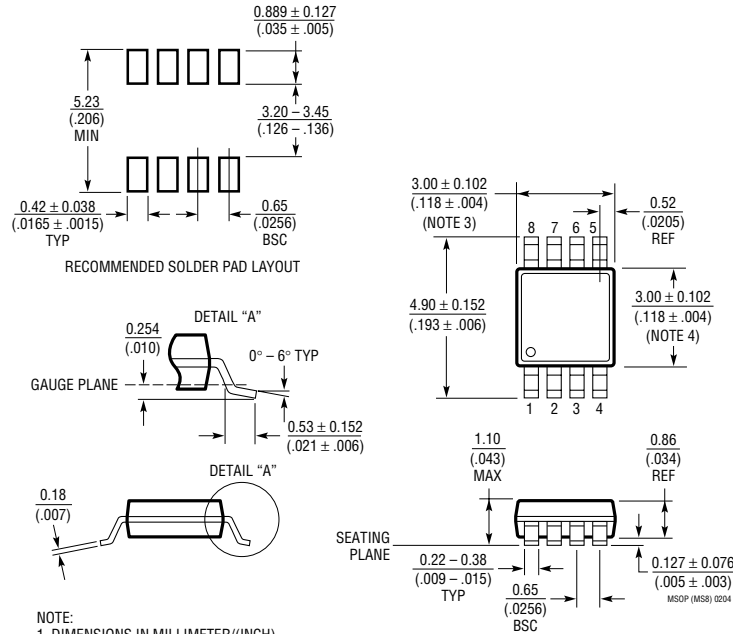

- NOTE:
1. DIMENSIONS IN MILLIMETER/(INCH)
  2. DRAWING NOT TO SCALE
  3. DIMENSION DOES NOT INCLUDE MOLD FLASH, PROTRUSIONS OR GATE BURRS.  
MOLD FLASH, PROTRUSIONS OR GATE BURRS SHALL NOT EXCEED 0.152mm (.006") PER SIDE
  4. DIMENSION DOES NOT INCLUDE INTERLEAD FLASH OR PROTRUSIONS.  
INTERLEAD FLASH OR PROTRUSIONS SHALL NOT EXCEED 0.152mm (.006") PER SIDE
  5. LEAD COPLANARITY (BOTTOM OF LEADS AFTER FORMING) SHALL BE 0.102mm (.004") MAX

## Z Package 3-Lead Plastic TO-92 (Similar to TO-226) (Reference LTC DWG # 05-08-1410)

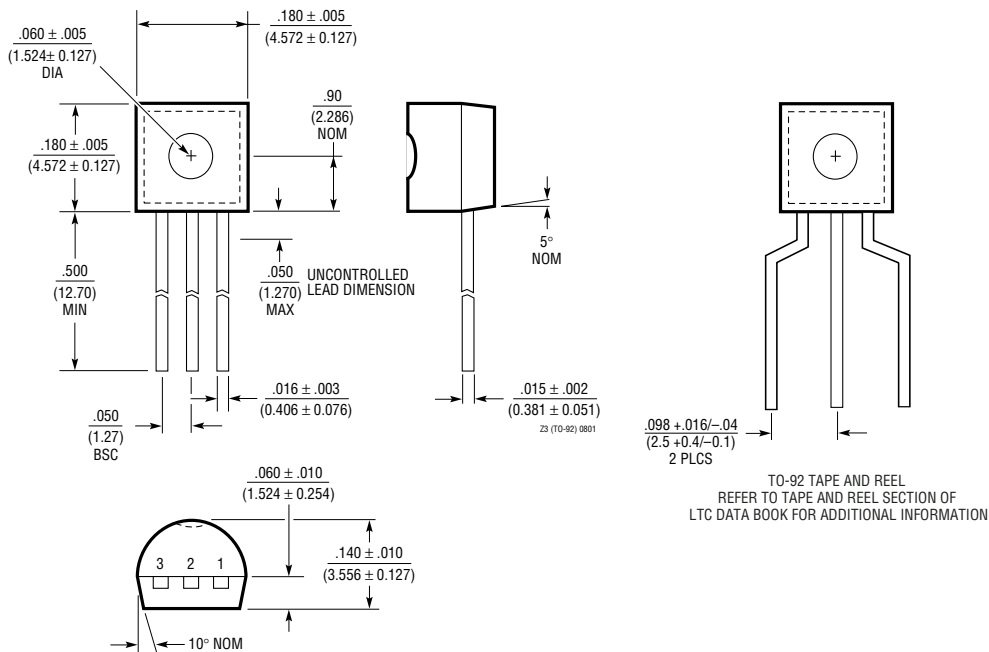

## TYPICAL APPLICATIONS

### Handling Higher Load Currents

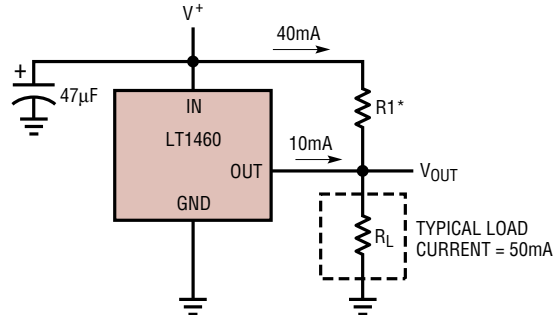

\*SELECT R1 TO DELIVER 80% OF TYPICAL LOAD CURRENT. LT1460 WILL THEN SOURCE AS NECESSARY TO MAINTAIN PROPER OUTPUT. DO NOT REMOVE LOAD AS OUTPUT WILL BE DRIVEN UNREGULATED HIGH. LINE REGULATION IS DEGRADED IN THIS APPLICATION

$$R1 = \frac{V^+ - V_{OUT}}{40mA}$$

1460 TA03

### Boosted Output Current with No Current Limit

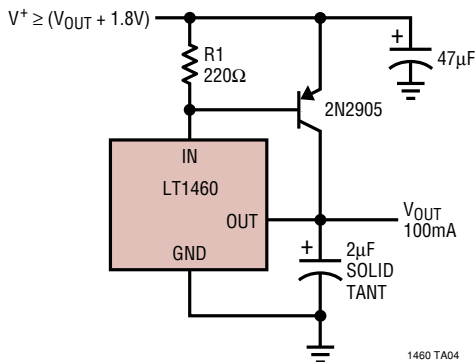

1460 TA04

### Boosted Output Current with Current Limit

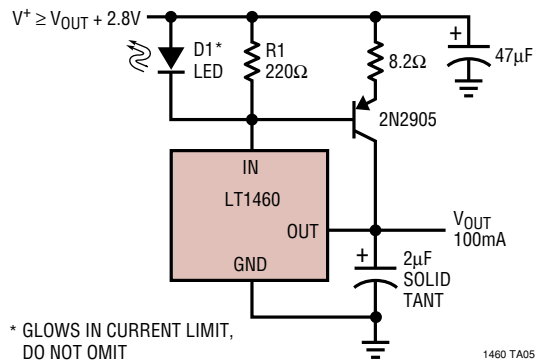

\* GLOWS IN CURRENT LIMIT, DO NOT OMIT

1460 TA05

## RELATED PARTS

PART NUMBER	DESCRIPTION	COMMENTS
LT1019	Precision Bandgap Reference	0.05% Max, 5ppm/°C Max
LT1027	Precision 5V Reference	0.02%, 2ppm/°C Max
LT1236	Precision Low Noise Reference	0.05% Max, 5ppm/°C Max, SO Package
LT1461	Micropower Precision Low Dropout	0.04% Max, 3ppm/°C Max, 50mA Output Current
LT1634	Micropower Precision Shunt Reference 1.25V, 2.5V Output	0.05%, 25ppm/°C Max
LT1790	Micropower Precision Series References	0.05% Max, 10ppm/°C Max, 60µA Supply, SOT23 Package
LTC®1798	Micropower Low Dropout Reference, Fixed or Adjustable	0.15% Max, 40ppm/°C, 6.5µA Max Supply Current
LT6660	Tiny Micropower Precision Series References	0.075% Max, 10ppm/°C Max, 20mA Output, 2mm × 2mm DFN Package





**Стандарт  
Электрон  
Связь**

Мы молодая и активно развивающаяся компания в области поставок электронных компонентов. Мы поставляем электронные компоненты отечественного и импортного производства напрямую от производителей и с крупнейших складов мира.

Благодаря сотрудничеству с мировыми поставщиками мы осуществляем комплексные и плановые поставки широчайшего спектра электронных компонентов.

Собственная эффективная логистика и склад в обеспечивает надежную поставку продукции в точно указанные сроки по всей России.

Мы осуществляем техническую поддержку нашим клиентам и предпродажную проверку качества продукции. На все поставляемые продукты мы предоставляем гарантию .

Осуществляем поставки продукции под контролем ВП МО РФ на предприятия военно-промышленного комплекса России , а также работаем в рамках 275 ФЗ с открытием отдельных счетов в уполномоченном банке. Система менеджмента качества компании соответствует требованиям ГОСТ ISO 9001.

Минимальные сроки поставки, гибкие цены, неограниченный ассортимент и индивидуальный подход к клиентам являются основой для выстраивания долгосрочного и эффективного сотрудничества с предприятиями радиоэлектронной промышленности, предприятиями ВПК и научно-исследовательскими институтами России.

С нами вы становитесь еще успешнее!

**Наши контакты:**

**Телефон:** +7 812 627 14 35

**Электронная почта:** [sales@st-electron.ru](mailto:sales@st-electron.ru)

**Адрес:** 198099, Санкт-Петербург,  
Промышленная ул, дом № 19, литера Н,  
помещение 100-Н Офис 331