

**ON Semiconductor®**



**KAF-1001 IMAGE SENSOR**

**1024 (H) X 1024 (V) FULL FRAME CCD IMAGE SENSOR**



**JUNE 18, 2014**

**DEVICE PERFORMANCE SPECIFICATION**

**REVISION 1.1 PS-0033**



## TABLE OF CONTENTS

<b>Summary Specification</b> .....	<b>4</b>
Description .....	4
Features .....	4
Applications .....	4
<b>Ordering Information</b> .....	<b>5</b>
<b>Device Description</b> .....	<b>6</b>
Architecture .....	6
Output Structure .....	6
Image Acquisition .....	7
Charge Transport .....	7
Physical Description .....	8
Pin Description and Device Orientation .....	8
<b>Imaging Performance</b> .....	<b>10</b>
Typical Operational Conditions .....	10
Specifications .....	10
Electro-Optical .....	10
CCD Parameters Common to Both Outputs .....	10
CCD Parameters Specific to High Output Amplifier .....	10
CCD Parameters Specific to Low Gain (High Dynamic Range) Output Amplifier .....	10
<b>Typical Performance Curves</b> .....	<b>12</b>
<b>Defect Definitions</b> .....	<b>14</b>
Specifications .....	14
<b>Operation</b> .....	<b>15</b>
Absolute Maximum Ratings .....	15
DC Bias Operating Conditions .....	15
AC Operating Conditions .....	16
Clock Levels .....	16
<b>Timing</b> .....	<b>17</b>
Requirements and Characteristics .....	17
Normal Readout .....	18
<b>Storage and Handling</b> .....	<b>19</b>
Storage Conditions .....	19
ESD .....	19
Cover Glass Care and Cleanliness .....	19
Environmental Exposure .....	19
Soldering Recommendations .....	19
<b>Mechanical Information</b> .....	<b>20</b>
Completed Assembly .....	20
<b>Quality Assurance and Reliability</b> .....	<b>22</b>
Quality and Reliability .....	22
Replacement .....	22
Liability of the Supplier .....	22
Liability of the Customer .....	22
Test Data Retention .....	22
Mechanical .....	22
<b>Life Support Applications Policy</b> .....	<b>22</b>
<b>Revision Changes</b> .....	<b>23</b>
MTD/PS-0195 .....	23



PS-0033 ..... 23

**TABLE OF FIGURES**

Figure 1: Block Diagram ..... 6

Figure 2: Pinout Diagram ..... 8

Figure 3: Typical Spectral Response..... 12

Figure 4: Dark Current as a Function of Temperature..... 13

Figure 5: Timing Diagram..... 18

Figure 6: Completed Assembly (1 of 2) ..... 20

Figure 7: Completed Assembly (2 of 2) ..... 21

## Summary Specification

### KAF-1001 Image Sensor

#### DESCRIPTION

The KAF-1001 Image Sensor is a high-performance charge-coupled device (CCD) designed for a wide range of image sensing applications.

The sensor incorporates true two-phase CCD technology, simplifying the support circuits required to drive the sensor as well as reducing dark current without compromising charge capacity. The sensor also utilizes the TRUESENSE Transparent Gate Electrode to improve sensitivity compared to the use of a standard front side illuminated polysilicon electrode.

Selectable on-chip output amplifiers allow operation to be optimized for different imaging needs: Low Noise (when using the high-sensitivity output) or Maximum Dynamic Range (when using the low-sensitivity output).

#### FEATURES

- True Two Phase Full Frame Architecture
- TRUESENSE Transparent Gate Electrode for high sensitivity
- 100% Fill Factor
- Low Dark Current
- Single Readout Register
- User-selectable outputs allow either Low Noise or High Dynamic Range operation

#### APPLICATIONS

- Scientific
- Medical

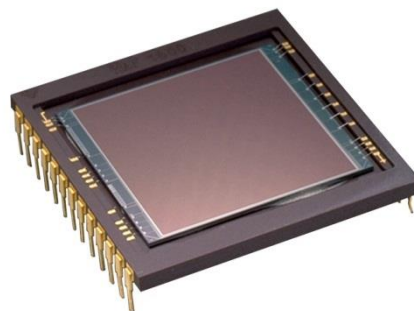

Parameter	Typical Value
Architecture	Full Frame CCD
Pixel Count	1024 (H) x 1024 (V)
Pixel Size	24 $\mu\text{m}$ (H) x 24 $\mu\text{m}$ (V)
Active Image Size	24.6 mm (H) x 24.6 mm (V)
Chip Size	28.6 mm (H) x 25.5 mm (V)
Optical Fill-Factor	100%
Saturation Signal	240,000 electrons
High Sensitivity Output	650,000 electrons
High Dynamic Range	
Output Sensitivity	11 $\mu\text{V}/\text{electron}$
High Sensitivity Output	2 $\mu\text{V}/\text{electron}$
High Dynamic Range	
Readout Noise (1 MHz)	15 electrons rms
Dark Current	<30 pA/cm <sup>2</sup>
(25 °C, Accumulation Mode)	
Dark Current Doubling Rate	5–6 °C
Dynamic Range (Sat Sig/Dark Noise)	83 dB
High Sensitivity Output	97 dB
High Dynamic Range	
Quantum Efficiency	40%, 55%, 65%
(450, 550, 650 nm)	
Maximum Data Rate	5 MHz
High Sensitivity Output	2 MHz
High Dynamic Range	
Transfer Efficiency (2 MHz, to –40 °C)	>0.99997
Package	CERDIP Package (sidebrazed)
Cover Glass	Clear



## Ordering Information

Catalog Number	Product Name	Description	Marking Code
4H0016	KAF- 1001-AAA-CP-B1	Monochrome, No Microlens, CERDIP Package (sidebrazed), Taped Clear Cover Glass, no coatings, Grade 1	KAF-1001-AAA [Serial Number]
4H0017	KAF- 1001-AAA-CP-B2	Monochrome, No Microlens, CERDIP Package (sidebrazed), Taped Clear Cover Glass, no coatings, Grade 2	
4H0019	KAF- 1001-AAA-CP-AE	Monochrome, No Microlens, CERDIP Package (sidebrazed), Taped Clear Cover Glass, no coatings, Engineering Sample	
4H0842	KAF- 1001-AAA-CB-AE	Monochrome, No Microlens, CERDIP Package (sidebrazed), Clear Cover Glass (no coatings), Engineering Sample	
4H0847	KAF- 1001-AAA-CB-B2	Monochrome, No Microlens, CERDIP Package (sidebrazed), Clear Cover Glass (no coatings), Grade 2	
4H0080	KEK-4H0080-KAF-1001-12-5	Evaluation Board (Complete Kit)	N/A

See Application Note *Product Naming Convention* for a full description of the naming convention used for image sensors. For reference documentation, including information on evaluation kits, please visit our web site at [www.truesenseimaging.com](http://www.truesenseimaging.com).

Please address all inquiries and purchase orders to:

Truesense Imaging, Inc.  
1964 Lake Avenue  
Rochester, New York 14615

Phone: (585) 784-5500  
E-mail: [info@truesenseimaging.com](mailto:info@truesenseimaging.com)

ON Semiconductor reserves the right to change any information contained herein without notice. All information furnished by ON Semiconductor is believed to be accurate.



## Device Description

### ARCHITECTURE

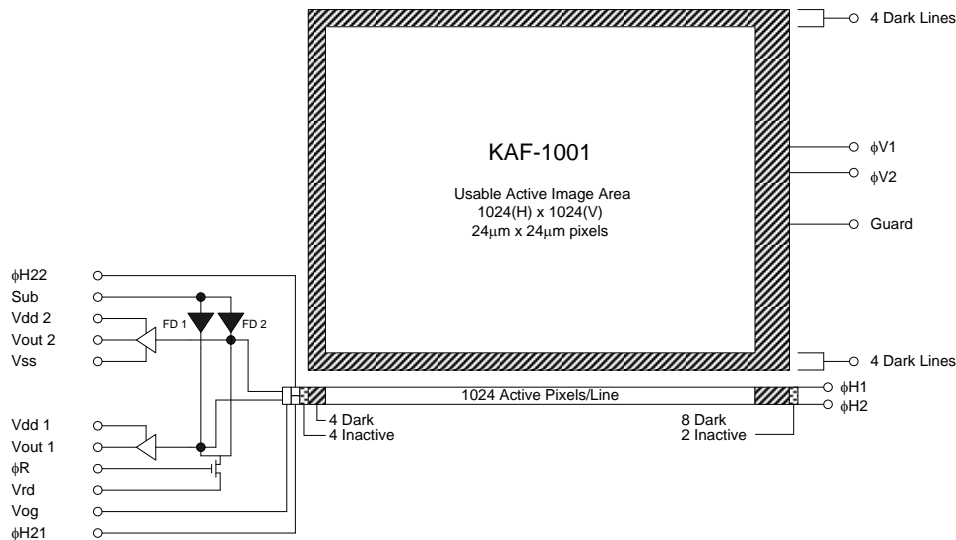

Figure 1: Block Diagram

**Notes:**

1. Shaded areas represent 4 non-imaging pixels at the beginning and 8 non-imaging pixels at the end of each line. There are also 4 non-imaging lines at the top and bottom of each frame.

Refer to the block diagram in Figure 1. The KAF-1001 consists of one vertical (parallel) CCD shift register, one horizontal (serial) CCD shift register and a selectable high or low gain output amplifier. Both registers incorporate true two-phase buried channel technology. The vertical register consists of 24 µm x 24 µm photo-capacitor sensing elements (pixels) which also serves as the transport mechanism. The pixels are arranged in a 1024 (H) x 1024 (V) array; an additional 12 columns (4 at the left and 8 at the right) and 8 rows (4 each at top and bottom) of non-imaging pixels are added as dark reference. Because there is no storage array, this device must be synchronized with strobe illumination or shuttered during readout.

### Output Structure

The final gate of the horizontal register is split into two sections, φH21 and φH22. The split gate structure allows the user to select either of the two output amplifiers. To use the high dynamic range single-stage output (Vout1), tie φH22 to a negative voltage to block charge transfer, and tie φH21 to φH2 to transfer charge. To use the high sensitivity two-stage output (Vout2), tie φH21 to a negative voltage and φH22 to φH2. The charge packets are then dumped onto the appropriate floating diffusion output node whose potential varies linearly with the quantity of charge in each packet. The amount of potential change is determined by the simple expression  $\Delta V_{fd} = \Delta Q / C_{fd}$ . The translation from electrons to voltages is called the output sensitivity or charge-to-voltage conversion. After the output has been sensed off-chip, the reset clock (φR) removes the charge from the floating diffusion via the reset drain (VRD). This, in turn, returns the floating diffusion potential to the reference level determined by the reset drain voltage.

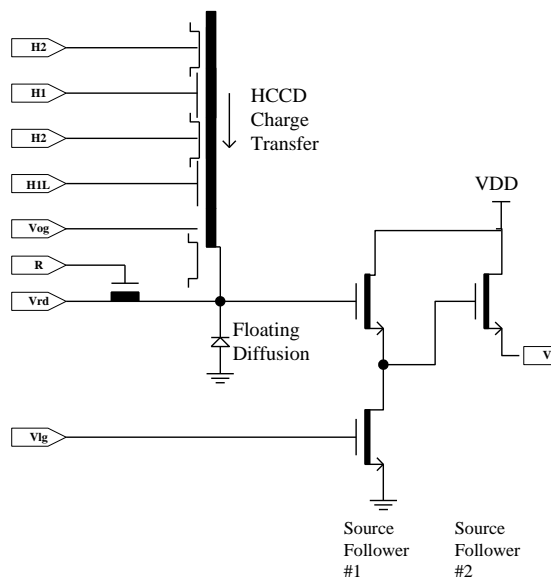

Figure 2: Output Schematic

## IMAGE ACQUISITION

An image is acquired when incident light, in the form of photons, falls on the array of pixels in the vertical CCD register and creates electron-hole pairs (or simply electrons) within the silicon substrate. This charge is collected locally by the formation of potential wells created at each pixel site by induced voltages on the vertical register clock lines ( $\phi V1$ ,  $\phi V2$ ). These same clock lines are used to implement the transport mechanism as well. The amount of charge collected at each pixel is linearly dependent on light level and exposure time and non-linearly dependent on wavelength until the potential well capacity is exceeded. At this point charge will 'bloom' into vertically adjacent pixels.

## CHARGE TRANSPORT

Integrated charge is transported to the output in a two-step process. Rows of charge are first shifted line by line into the horizontal CCD. 'Lines' of charge are then shifted to the output pixel by pixel. Referring to the timing diagram, integration of charge is performed with  $\phi V1$  and  $\phi V2$  held low. Transfer to horizontal CCD begins when  $\phi V1$  is brought high causing charge from the  $\phi V1$  and  $\phi V2$  gates to combine under the  $\phi V1$  gate.

$\phi V1$  and  $\phi V2$  now reverse their polarity causing the charge packets to 'spill' forward under the  $\phi V2$  gate of the next pixel. The rising edge of  $\phi V2$  also transfers the first line of charge into the horizontal CCD. A second phase transition places the charge packets under the  $\phi V1$  electrode of the next pixel. The sequence completes when  $\phi V1$  is brought low. Clocking of the vertical register in this way is known as accumulation mode clocking. Next, the horizontal CCD reads out the first line of charge using traditional complementary clocking (using  $\phi H1$  and  $\phi H2$  pins) as shown. The falling edge of  $\phi H2$  forces a charge packet over the output gate (OG) onto one of the output nodes (floating diffusion) which controls the output amplifier. The cycle repeats until all lines are read.



**PHYSICAL DESCRIPTION**

**Pin Description and Device Orientation**

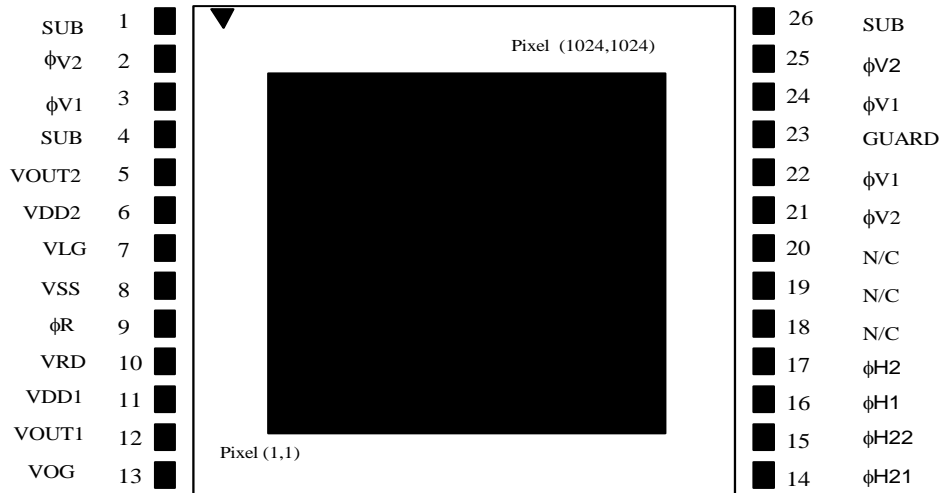

Figure 3: Pinout Diagram





Pin	Name	Description
1	Substrate	Substrate
2	$\phi V2$	Vertical (Parallel) CCD Clock – Phase 2
3	$\phi V1$	Vertical (Parallel) CCD Clock – Phase 1
4	Substrate	Substrate
5	VOUT2	Video Output from High Sensitivity Two-Stage Amplifier
6	VDD2	High Sensitivity Two-Stage Amplifier Supply
7	VLG	First Stage Load Transistor Gate for Two-Stage Amplifier
8	VSS	Output Amplifier Return
9	$\phi R$	Reset Clock
10	VRD	Reset Drain
11	VDD1	High Dynamic Range Single-Stage Amplifier Supply
12	VOUT1	Video Output from High Dynamic Range Single-Stage Amplifier
13	OG	Output Gate

Pin	Name	Description
14	$\phi H21$	Last Horizontal (Serial) CCD Phase - Split Gate
15	$\phi H22$	Last Horizontal (Serial) CCD Phase - Split Gate
16	$\phi H1$	Horizontal (Serial) CCD Clock - Phase 1
17	$\phi H2$	Horizontal (Serial) CCD Clock - Phase 2
18	N/C	No Connection
19	N/C	No Connection
20	N/C	No Connection
21	$\phi V2$	Vertical (Parallel) CCD Clock – Phase 2
22	$\phi V1$	Vertical (Parallel) CCD Clock – Phase 1
23	Guard	Guard Ring
24	$\phi V1$	Vertical (Parallel) CCD Clock – Phase 1
25	$\phi V2$	Vertical (Parallel) CCD Clock – Phase 2
26	Substrate	Substrate

## Notes:

1. Pins 3, 22, and 24 must be connected together - only one Phase 1 clock driver is required.
2. Pins 2, 21, and 25 must be connected together - only one Phase 2 clock driver is required.



## Imaging Performance

### TYPICAL OPERATIONAL CONDITIONS

All values derived using nominal operating conditions with the recommended timing. Correlated doubling sampling of the output is assumed and recommended. Many units are expressed in electrons: to convert to voltage, multiply by the amplifier sensitivity.

### SPECIFICATIONS

#### Electro-Optical

Description	Symbol	Min	Nom	Max	Units	Notes	Verification Plan
Optical Fill Factor	FF		100		%		
Photoresponse Non-uniformity	PRNU			5	% rms	Full Array	die <sup>10</sup>
Quantum Efficiency (450, 550, 650 nm)	QE						design <sup>11</sup>

#### CCD Parameters Common to Both Outputs

Description	Symbol	Min	Nom	Max	Units	Notes	Verification Plan
Sat. Signal - Vccd Register	$N_{e\text{-sat}}$	450	500		$ke^-$	2	design <sup>11</sup>
Dark Current	Jd		15.3 550	30 1080	$\mu A/cm^2$ $e^-/pixel/sec$	25 °C (mean of all pixels)	die <sup>10</sup>
Dark Current Doubling Temp	DCDR	5	6	7	°C		design <sup>11</sup>
Dark Signal Non-uniformity	DSNU			1080	$e^-/pix/sec$	4	die <sup>10</sup>
Charge Transfer Efficiency	CTE		.99997			5	die <sup>10</sup>
V-H CCD Transfer Time	$t_{VH}$		32		$\mu s$	6,7	design <sup>11</sup>
Blooming Suppression	Bs		none				

#### CCD Parameters Specific to High Output Amplifier

Description	Symbol	Min	Nom	Max	Units	Notes	Verification Plan
Output Sensitivity	$V_{out}/Ne^-$	9	11		$\mu V/electron$		design <sup>11</sup>
Sat. Signal	$N_{e\text{-sat}}$	180	200	240	$ke^-$	1	design <sup>11</sup>
Total Sensor Noise	$n_{e\text{-total}}$		13	20	$e^- rms$	8	design <sup>11</sup>
Horizontal CCD Frequency:	$f_H$		2	5	MHz	6	design <sup>11</sup>
Dynamic Range:	DR	79	83		dB	9	design <sup>11</sup>

#### CCD Parameters Specific to Low Gain (High Dynamic Range) Output Amplifier

Description	Symbol	Min	Nom	Max	Units	Notes	Verification Plan
Output Sensitivity	$V_{out}/Ne^-$	1.7	2		$\mu V/electron$		die <sup>10</sup>
Sat. Signal	$N_{e\text{-sat}}$	1400	1500	1800	$ke^-$	3	design <sup>11</sup>
Total Sensor Noise	$n_{e\text{-total}}$		22	30	$e^- rms$	8	die <sup>10</sup>
Horizontal CCD Frequency:	$f_H$		0.5	2	MHz	6	design <sup>11</sup>
Dynamic Range :	DR	93	97		dB	9	design <sup>11</sup>



## Notes:

1. Point where the output saturates when operated with nominal voltages.
2. Signal level at the onset of blooming in the vertical (parallel) CCD register
3. Maximum signal level at the output of the high dynamic range output. This signal level will only be achieved when binning pixels containing large signals.
4. None of 64 sub arrays (128 x 128) exceed the maximum dark current specification.
5. For 2 MHz data rate and T = 30 °C to -40 °C.
6. Using maximum CCD frequency and/or minimum CCD transfer times may compromise performance
7. Time between the rising edge of  $\phi V1$  and the first falling edge of  $\phi H1$
8. At  $T_{\text{integration}} = 0$ ; data rate = 1 MHz; temperature = -30 °C
9. Uses  $20\text{LOG}(N_{e_{\text{sat}}}^- / n_{e_{\text{total}}}^-)$  where  $N_{e_{\text{sat}}}^-$  refers to the amplifier saturation signal.
10. A parameter that is measured on every sensor during production testing.
11. A parameter that is quantified during the design verification activity.



## Typical Performance Curves

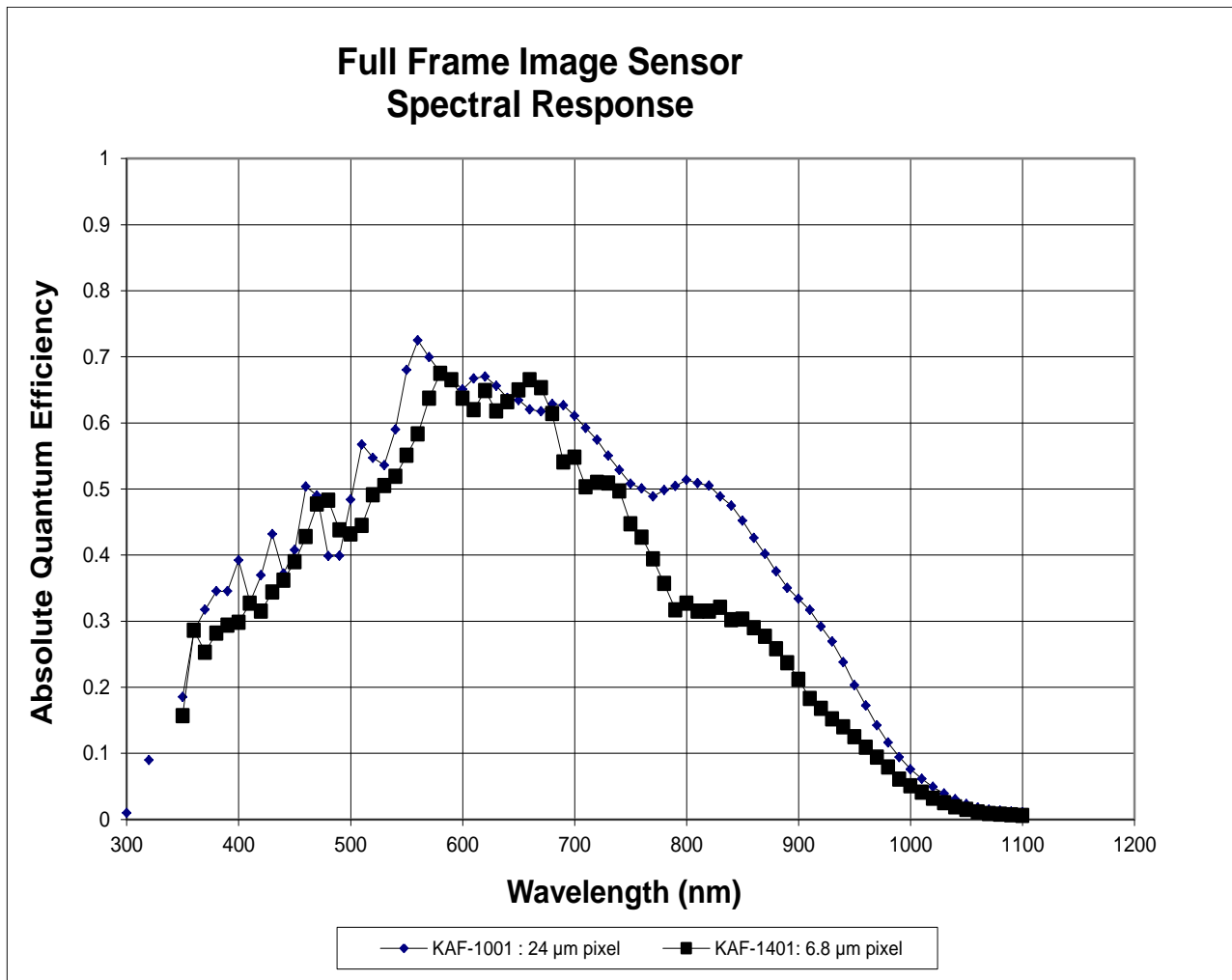

Figure 4: Typical Spectral Response

Figure 4 shows a representative spectral response of front side illuminated transparent gate full frame image sensors. The KAF-1001 with 24 μm pixels has higher response than the 6.8 μm pixel sensor at wavelengths greater than 750 nm because it is constructed on a lower resistivity silicon substrate. The resulting collection volume of each pixel more efficiently collects signal generated deeper within the silicon.

Most of the two phase CCD pixels are designed so that each of the electrodes occupies half of the pixel area. The KAF-1001 was not designed this way but instead is designed with the transparent electrode occupying greater than half the pixel area. This further improves the benefits of the transparent gate.



### KAF-1001 Dark Current

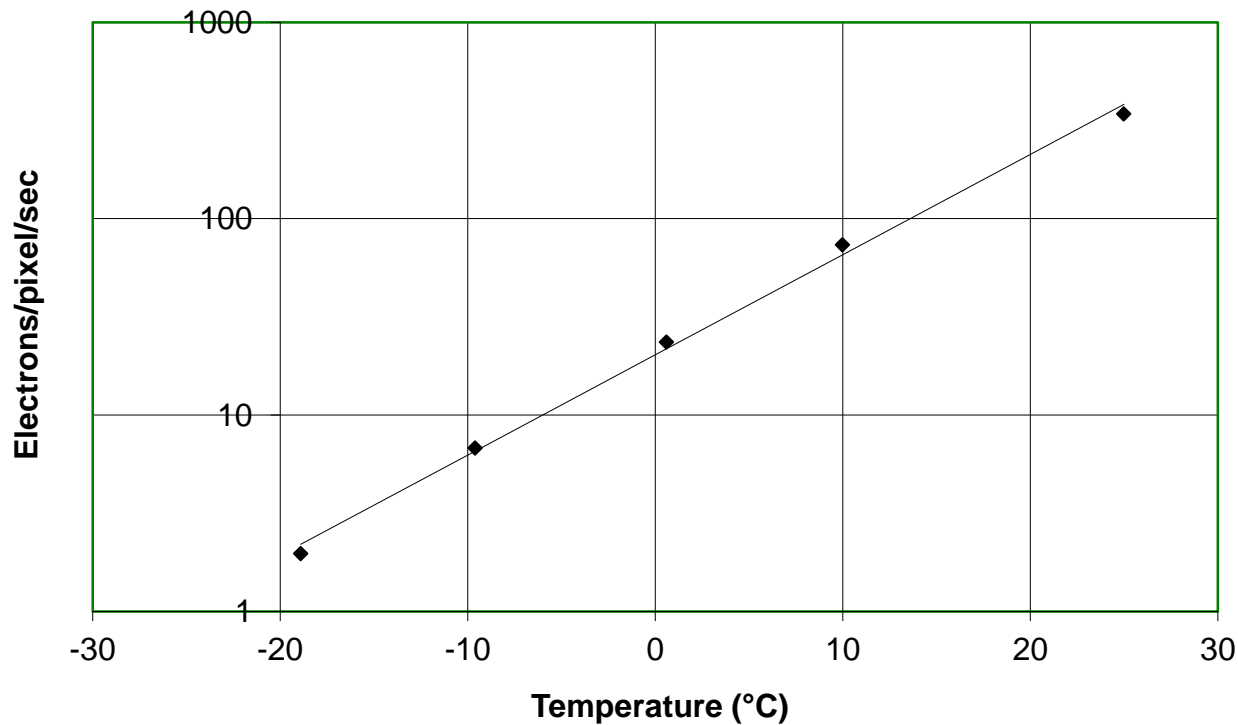

Figure 5: Dark Current as a Function of Temperature



## Defect Definitions

### SPECIFICATIONS

Classification	Point Defect	Cluster Defect	Column Defect
C1	20	2	0
C2	40	10	2

- Dark Defects**      A pixel which deviates by more than 20% from neighboring pixels when illuminated to 70% of saturation
- Bright Defect**      A pixel whose dark current exceeds 4500 electrons/pixel/second at 25 °C
- Cluster Defect**      A grouping of not more than 5 adjacent point defects
- Column Defect**      A grouping point defects along a single column. (Dark Column)  
                                  A column that contains a pixel whose dark current exceeds 150,000 electrons/pixel/second at 25 °C. (Bright Column)  
                                  A column that does not exhibit the minimum charge capacity specification. (Low charge capacity)  
                                  A column that loses >500 electrons when the array is illuminated to a signal level of 2000 electrons/pix. (Trap like defects)
- Neighboring Pixels**      The surrounding 128 x 128 pixels or ± 64 column/rows
- Defect Separation**      Defects are separated by no less than 3 pixels in any one direction.

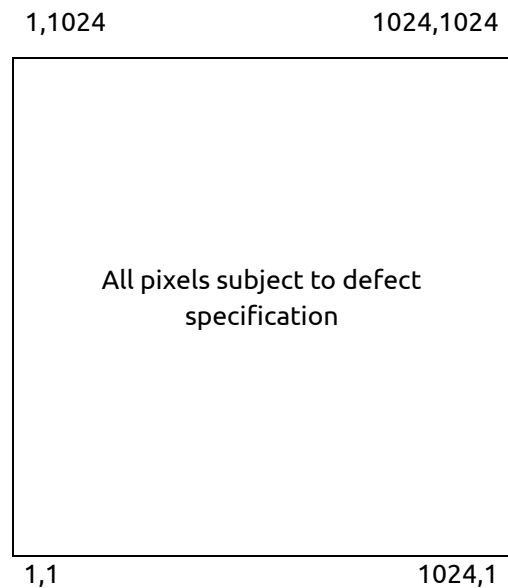

Figure 6: Active Pixel Region



## Operation

### ABSOLUTE MAXIMUM RATINGS

Description	Symbol	Minimum	Maximum	Units	Notes
Storage Temperature	$T_{ST}$	-100	+80	C	At Device
Operating Temperature	$T_{OP}$	-50	+50	C	At Device
Voltage	All Clocks	-16	+16	V	VSUB = 0 V
Voltage	OG	0	+8	V	VSUB = 0 V
Voltage	VRD, VSS, VDD, GUARD	0	+20	V	VSUB = 0 V
Current	Output Bias Current (IDD)		10	mA	
Capacitance	Output Load Capacitance (CLOAD)		10	pF	
Frequency/Time	$\phi V1$ , $\phi V2$ Pulse Width	8		$\mu s$	
Frequency/Time	$\phi H1$ , $\phi H2$		5	MHz	
Frequency/Time	$\phi R$ Pulse Width	20		ns	

#### Warning:

For maximum performance, built-in gate protection has been added only to the OG pin. These devices require extreme care during handling to prevent electrostatic discharge (ESD) induced damage.

### DC BIAS OPERATING CONDITIONS

Description	Symbol	Minimum	Nominal	Maximum	Units	Pin Impedance	Notes
Substrate	VSUB	0.0	0.0	0.0	V	Common	
Output Amplifier Supply	VDD	15.0	+17.0	17.5	V	5 pF, 2 K $\Omega$	1
Output Amplifier Return	VSS	1.4	+2.0	2.1	V	5 pF, 2 K $\Omega$	
Reset Drain	VRD	11.5	+12	12.5	V	5 pF, 1 M $\Omega$	
Output Gate	OG	3.0	+4.0	4.5	V	5 pF, 10 M $\Omega$	
Guard Ring	GUARD	7.0	+10.0	15.0	V	350 pF, 10 M $\Omega$	
Load Gate	VLG	VSS - 0.5	VSS + 0.0	VSS + 1.0	V		

#### Notes:

1. Vdd = 17 volts for applications where the expected output voltage > 2.0 volts. For applications where the expected useable output voltage is < 2 volts, Vdd can be reduced to 15 volts.



## AC OPERATING CONDITIONS

### Clock Levels

Description	Symbol	Level	Minimum	Nominal	Maximum	Units	Pin Impedance
Vertical Clock - Phase 1	$\phi V1$	Low	-10.25	-10	-9.8	V	200 nF, 10 M $\Omega$
Vertical Clock - Phase 1	$\phi V1$	High	0.0	0	1.0	V	
Vertical Clock - Phase 2	$\phi V2$	Low	-10.25	-10.0	-9.8	V	200 nF, 10 M $\Omega$
Vertical Clock - Phase 2	$\phi V2$	High	0.0	0	1.0	V	C $\phi V1-V2$ = 100 nF
Horizontal Clock - Phase 1	$\phi H1$	Low	-2.2	-2.0	-1.8	V	400 pF, 10 M $\Omega$
Horizontal Clock - Phase 1	$\phi H1$	High	7.8	+8.0	8.2	V	
Horizontal Clock - Phase 2	$\phi H2$	Low	-2.2	-2.0	-1.8	V	250 pF, 10 M $\Omega$
Horizontal Clock - Phase 2	$\phi H2$	High	7.8	+8.0	8.2	V	C $\phi H1-H2$ = 200 pF
Reset Clock	$\phi R$	Low	2.0	3.0	3.5	V	10 pF, 10 M $\Omega$
Reset Clock	$\phi R$	High	9.5	10.0	11.0	V	

Description	Symbol	Level	Using the High Gain Output (Vout2)			Using the High Dynamic Range Output (Vout1)			Units	Pin Impedance
			Min	Nom	Max	Min	Nom	Max		
Horizontal Clock - Phase 1	$\phi H21$	Low	-4	$\phi H2$ low	$\phi H2$ low		$\phi H2$		V	10 pF, 10 M $\Omega$
Horizontal Clock - Phase 1	$\phi H21$	High	-4	$\phi H2$ low	$\phi H2$ low		$\phi H2$		V	
Horizontal Clock - Phase 2	$\phi H22$	Low		$\phi H2$			$\phi H2$ low	$\phi H2$ low	V	10 pF, 10 M $\Omega$
Horizontal Clock - Phase 2	$\phi H22$	High		$\phi H2$			$\phi H2$ low	$\phi H2$ low	V	

#### Notes:

When using Vout1,  $\phi H21$  is clocked identically with  $\phi H2$  while  $\phi H22$  is held at a static level. When using Vout2,  $\phi H21$  and  $\phi H22$  are exchanged so that  $\phi H22$  is identical to  $\phi H2$  and  $\phi H21$  is held at a static level. The static level should be the same voltage as  $\phi H2$  low.

The AC and DC operating levels are for room temperature operation. Operation at other temperatures may require adjustments of these voltages. Pins shown with impedances greater than 1 M $\Omega$  are expected resistances. These pins are only verified to 1 M $\Omega$ .

$\phi V1, 2$  capacitances are accumulated gate oxide capacitance, and are an over-estimate of the capacitance.

This device is suitable for a wide range of applications requiring a variety of different operating conditions. Consult Truesense Imaging in those situations in which operating conditions meet or exceed minimum or maximum levels.





## Timing

### REQUIREMENTS AND CHARACTERISTICS

Description	Symbol	Minimum	Nominal	Maximum	Units	Notes
$\phi$ H1, $\phi$ H2 Clock Frequency	$f_H$		4	5	MHz	1, 2, 3
$\phi$ V1, $\phi$ V2 Clock Frequency	$f_V$		100	125	kHz	1, 2, 3
Pixel Period (1 Count)	$t_{pix}$	200	250		ns	
$\phi$ H1, $\phi$ H2 Setup Time	$t_{\phi HS}$	500	1000		ns	
$\phi$ V1, $\phi$ V2 Clock Pulse Width	$t_{\phi V}$	4	5		$\mu$ s	2
Reset Clock Pulse Width	$t_{\phi R}$	20	60		ns	4
Readout Time	$t_{readout}$	226	286		ms	5
Integration Time	$t_{int}$					6
Line Time	$t_{line}$	219	277		$\mu$ s	7

#### Notes:

1. 50% duty cycle values.
2. CTE may degrade above the nominal frequency.
3. Rise and fall times (10 / 90% levels) should be limited to 5-10% of clock period. Crossover of register clocks should be between 40-60% of amplitude.
4.  $\phi$ R should be clocked continuously
5.  $t_{readout} = (1032 * t_{line})$
6. Integration time ( $t_{int}$ ) is user specified. Longer integration times will degrade noise performance due to dark signal fixed pattern and shot noise.
7.  $t_{line} = (3 * t_{\phi V}) + t_{\phi HS} + 1044 * t_{pix} + t_{pix}$



**NORMAL READOUT**

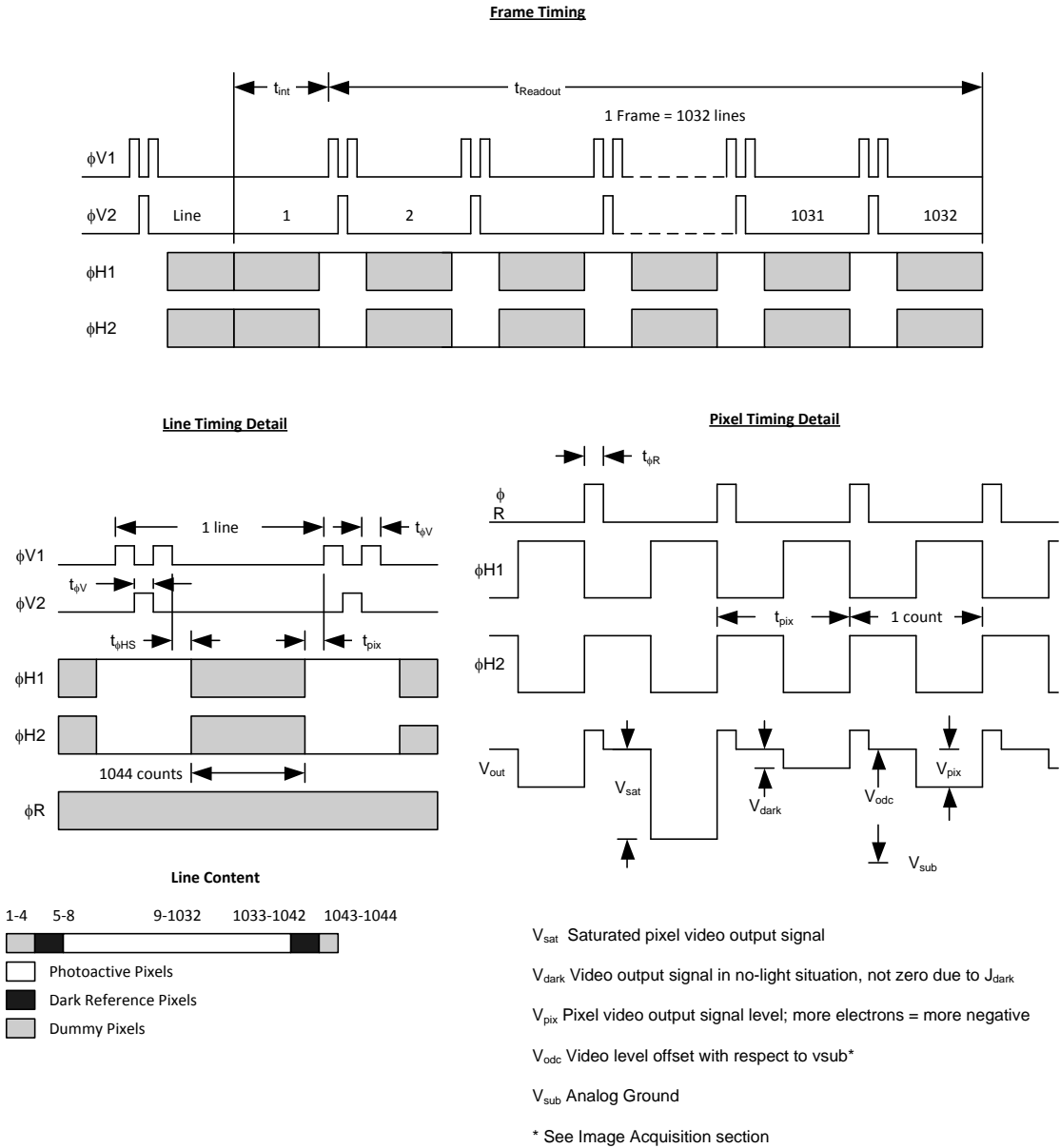

Figure 7: Timing Diagram

**Notes:**

1. This device is suitable for a wide range of applications requiring a variety of different timing frequencies. Therefore, only maximum and minimum values are shown above. Consult Truesense Imaging in those situations that require special consideration.



## Storage and Handling

### STORAGE CONDITIONS

Description	Symbol	Minimum	Maximum	Units	Notes
Storage Temperature	T <sub>ST</sub>	-100	+80	°C	At Device
Operating Temperature	T <sub>OP</sub>	-50	+50	°C	

### ESD

1. This device contains limited protection against Electrostatic Discharge (ESD). ESD events may cause irreparable damage to a CCD image sensor either immediately or well after the ESD event occurred. Failure to protect the sensor from electrostatic discharge may affect device performance and reliability.
2. Devices should be handled in accordance with strict ESD procedures for Class 0 (<250 V per JESD22 Human Body Model test), or Class A (<200 V JESD22 Machine Model test) devices. Devices are shipped in static-safe containers and should only be handled at static-safe workstations.
3. See Application Note *Image Sensor Handling Best Practices* for proper handling and grounding procedures. This application note also contains workplace recommendations to minimize electrostatic discharge.
4. Store devices in containers made of electro-conductive materials.

### COVER GLASS CARE AND CLEANLINESS

1. The cover glass is highly susceptible to particles and other contamination. Perform all assembly operations in a clean environment.
2. Touching the cover glass must be avoided.
3. Improper cleaning of the cover glass may damage these devices. Refer to Application Note *Image Sensor Handling Best Practices*.

### ENVIRONMENTAL EXPOSURE

1. Extremely bright light can potentially harm CCD image sensors. Do not expose to strong sunlight for long periods of time, as the color filters and/or microlenses may become discolored. In addition, long time exposures to a static high contrast scene should be avoided. Localized changes in response may occur from color filter/microlens aging. For Interline devices, refer to Application Note *Using Interline CCD Image Sensors in High Intensity Visible lighting Conditions*.
2. Exposure to temperatures exceeding maximum specified levels should be avoided for storage and operation, as device performance and reliability may be affected.
3. Avoid sudden temperature changes.
4. Exposure to excessive humidity may affect device characteristics and may alter device performance and reliability, and therefore should be avoided.
5. Avoid storage of the product in the presence of dust or corrosive agents or gases, as deterioration of lead solderability may occur. It is advised that the solderability of the device leads be assessed after an extended period of storage, over one year.

### SOLDERING RECOMMENDATIONS

1. The soldering iron tip temperature is not to exceed 370 °C. Higher temperatures may alter device performance and reliability.
2. Flow soldering method is not recommended. Solder dipping can cause damage to the glass and harm the imaging capability of the device. Recommended method is by partial heating using a grounded 30 W soldering iron. Heat each pin for less than 2 seconds duration.



## Mechanical Information

### COMPLETED ASSEMBLY

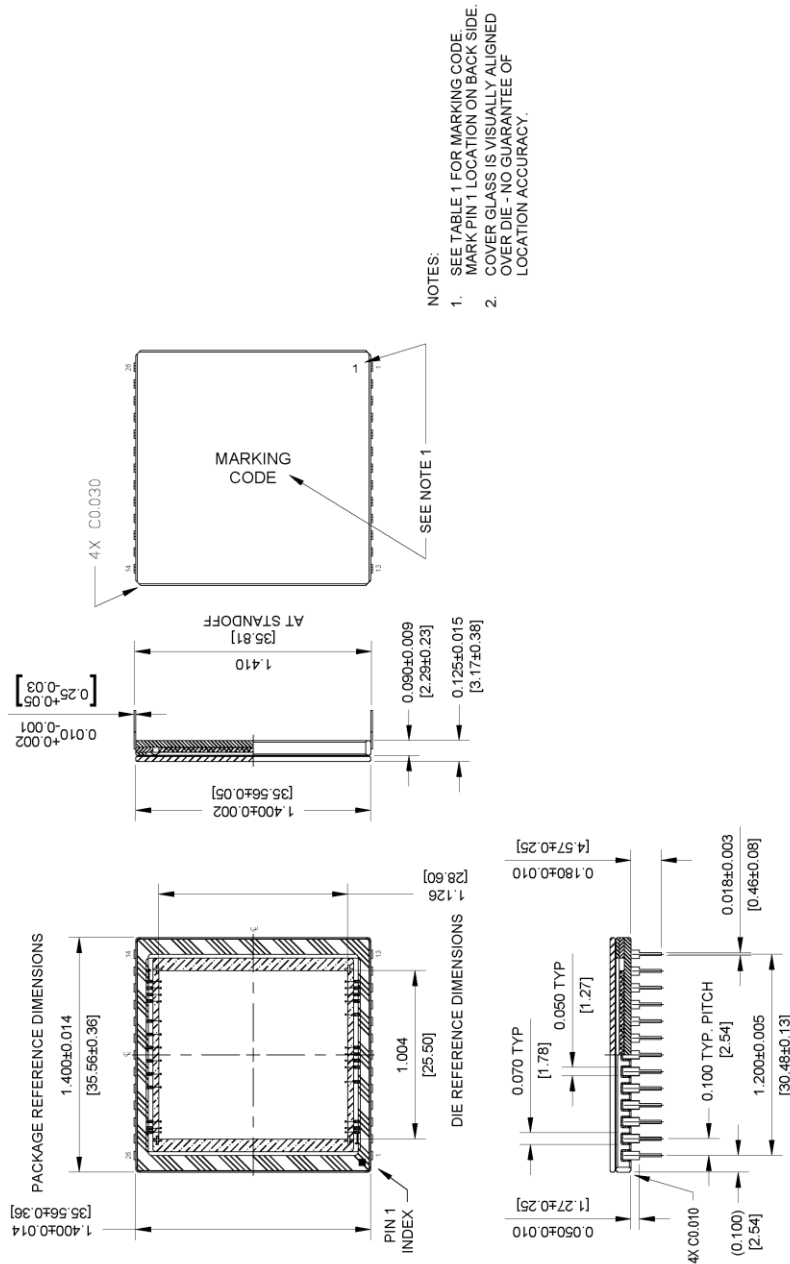

Figure 8: Completed Assembly (1 of 2)

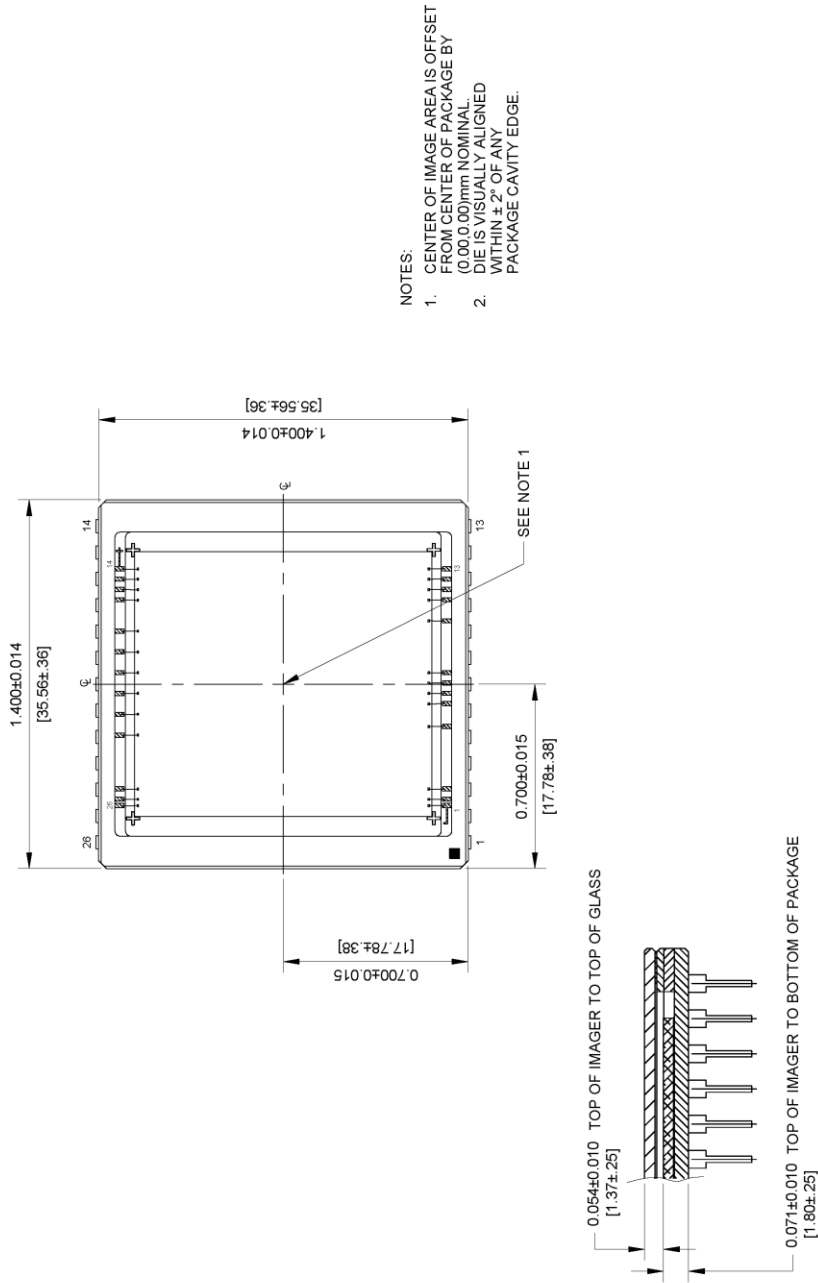

Figure 9: Completed Assembly (2 of 2)



## Quality Assurance and Reliability

### QUALITY AND RELIABILITY

All image sensors conform to the specifications stated in this document. This is accomplished through a combination of statistical process control and visual inspection and electrical testing at key points of the manufacturing process, using industry standard methods. Information concerning the quality assurance and reliability testing procedures and results are available from ON Semiconductor upon request. For further information refer to Application Note *Quality and Reliability*.

### REPLACEMENT

All devices are warranted against failure in accordance with the *Terms of Sale*. Devices that fail due to mechanical and electrical damage caused by the customer will not be replaced.

### LIABILITY OF THE SUPPLIER

A reject is defined as an image sensor that does not meet all of the specifications in this document upon receipt by the customer. Product liability is limited to the cost of the defective item, as defined in the *Terms of Sale*.

### LIABILITY OF THE CUSTOMER

Damage from mishandling (scratches or breakage), electrostatic discharge (ESD), or other electrical misuse of the device beyond the stated operating or storage limits, which occurred after receipt of the sensor by the customer, shall be the responsibility of the customer.

### TEST DATA RETENTION

Image sensors shall have an identifying number traceable to a test data file. Test data shall be kept for a period of 2 years after date of delivery.

### MECHANICAL

The device assembly drawing is provided as a reference.

ON Semiconductor reserves the right to change any information contained herein without notice. All information furnished by ON Semiconductor is believed to be accurate.

## Life Support Applications Policy

ON Semiconductor image sensors are not authorized for and should not be used within Life Support Systems without the specific written consent of ON Semiconductor.



## Revision Changes

### MTD/PS-0195

Revision Number	Description of Changes
1.0	<ul style="list-style-type: none"> <li>Initial Release.</li> </ul>
2.0	<ul style="list-style-type: none"> <li>Section 4.1, CCD Parameters Common to both Outputs:               <ul style="list-style-type: none"> <li><math>N_{e-sat}</math> (Sat. Signal – Vccd) Register:                   <ul style="list-style-type: none"> <li>Minimum changed from 550 to 450 <math>ke^-</math></li> <li>Nominal changed from 650 to 500 <math>ke^-</math></li> </ul> </li> </ul> </li> <li>Eliminated Appendix 1 - Available Part Numbers</li> <li>Added Section 6.1: Revision Changes</li> <li>Section 4.2 Cosmetic Grades               <ul style="list-style-type: none"> <li>Eliminate Grade 3</li> <li>Remove UV grade</li> <li>Allow 2 columns in Grade 2</li> </ul> </li> <li>Section 5. Quality and Reliability               <ul style="list-style-type: none"> <li>Revised descriptions.</li> </ul> </li> </ul>
3.0	<ul style="list-style-type: none"> <li>Updated format. Removed part numbers.</li> </ul>
4.0	<ul style="list-style-type: none"> <li>Pg 14 - Corrected Column and Point Defect Table Headings</li> </ul>
5.0	<ul style="list-style-type: none"> <li>Changed wavelength band to 400 nm to 1100 nm</li> <li>Changed High Sensitivity Output to 11 <math>\mu V/electron</math></li> <li>Changed Dynamic Range (Sat Sig/Dark Noise)</li> <li>High Sensitivity Output to 83 dB</li> <li>High Dynamic Range to 97 dB</li> <li>Changed CCD Parameters Common to Both Outputs - Dark Current to <math>pA/cm^2 e^-/pixel/sec</math></li> <li>Changed CCD Parameters Specific to Low Gain (High Dynamic Range) Output Amplifier - Dynamic Range to Min. 93, Nom. 97</li> <li>Updated Defect Specification</li> <li>Changed Note 9 on p 11 to amplifier saturation signal</li> </ul>
6.0	<ul style="list-style-type: none"> <li>Pg 7 – Added Output amplifier schematic.</li> <li>Pg 15 – Updated DC Operating Conditions.</li> </ul>

### PS-0033

Revision Number	Description of Changes
1.0	<ul style="list-style-type: none"> <li>Initial release with new document number, updated branding and document template</li> <li>Updated <i>Storage and Handling</i> and <i>Quality Assurance and Reliability</i> sections</li> </ul>
1.1	<ul style="list-style-type: none"> <li>Updated branding</li> </ul>

ON Semiconductor and are registered trademarks of Semiconductor Components Industries, LLC (SCILLC). SCILLC owns the rights to a number of patents, trademarks, copyrights, trade secrets, and other intellectual property. A listing of SCILLC's product/patent coverage may be accessed at [www.onsemi.com/site/pdf/Patent-Marking.pdf](http://www.onsemi.com/site/pdf/Patent-Marking.pdf). SCILLC reserves the right to make changes without further notice to any products herein. SCILLC makes no warranty, representation or guarantee regarding the suitability of its products for any particular purpose, nor does SCILLC assume any liability arising out of the application or use of any product or circuit, and specifically disclaims any and all liability, including without limitation special, consequential or incidental damages. "Typical" parameters which may be provided in SCILLC data sheets and/or specifications can and do vary in different applications and actual performance may vary over time. All operating parameters, including "Typicals" must be validated for each customer application by customer's technical experts. SCILLC does not convey any license under its patent rights nor the rights of others. SCILLC products are not designed, intended, or authorized for use as components in systems intended for surgical implant into the body, or other applications intended to support or sustain life, or for any other application in which the failure of the SCILLC product could create a situation where personal injury or death may occur. Should Buyer purchase or use SCILLC products for any such unintended or unauthorized application, Buyer shall indemnify and hold SCILLC and its officers, employees, subsidiaries, affiliates, and distributors harmless against all claims, costs, damages, and expenses, and reasonable attorney fees arising out of, directly or indirectly, any claim of personal injury or death associated with such unintended or unauthorized use, even if such claim alleges that SCILLC was negligent regarding the design or manufacture of the part. SCILLC is an Equal Opportunity/Affirmative Action Employer. This literature is subject to all applicable copyright laws and is not for resale in any manner.

#### PUBLICATION ORDERING INFORMATION

##### LITERATURE FULFILLMENT:

Literature Distribution Center for ON Semiconductor  
 P.O. Box 5163, Denver, Colorado 80217 USA  
**Phone:** 303-675-2175 or 800-344-3860 Toll Free USA/Canada  
**Fax:** 303-675-2176 or 800-344-3867 Toll Free USA/Canada  
**Email:** [orderlit@onsemi.com](mailto:orderlit@onsemi.com)

**N. American Technical Support:** 800-282-9855 Toll Free  
 USA/Canada

**Europe, Middle East and Africa Technical Support:**  
 Phone: 421 33 790 2910

**Japan Customer Focus Center**  
 Phone: 81-3-5817-1050

**ON Semiconductor Website:** [www.onsemi.com](http://www.onsemi.com)

**Order Literature:** <http://www.onsemi.com/orderlit>

For additional information, please contact your local Sales Representative



## Стандарт Электрон Связь

Мы молодая и активно развивающаяся компания в области поставок электронных компонентов. Мы поставляем электронные компоненты отечественного и импортного производства напрямую от производителей и с крупнейших складов мира.

Благодаря сотрудничеству с мировыми поставщиками мы осуществляем комплексные и плановые поставки широчайшего спектра электронных компонентов.

Собственная эффективная логистика и склад в обеспечивает надежную поставку продукции в точно указанные сроки по всей России.

Мы осуществляем техническую поддержку нашим клиентам и предпродажную проверку качества продукции. На все поставляемые продукты мы предоставляем гарантию .

Осуществляем поставки продукции под контролем ВП МО РФ на предприятия военно-промышленного комплекса России , а также работаем в рамках 275 ФЗ с открытием отдельных счетов в уполномоченном банке. Система менеджмента качества компании соответствует требованиям ГОСТ ISO 9001.

Минимальные сроки поставки, гибкие цены, неограниченный ассортимент и индивидуальный подход к клиентам являются основой для выстраивания долгосрочного и эффективного сотрудничества с предприятиями радиоэлектронной промышленности, предприятиями ВПК и научно-исследовательскими институтами России.

С нами вы становитесь еще успешнее!

### Наши контакты:

**Телефон:** +7 812 627 14 35

**Электронная почта:** [sales@st-electron.ru](mailto:sales@st-electron.ru)

**Адрес:** 198099, Санкт-Петербург,  
Промышленная ул, дом № 19, литера Н,  
помещение 100-Н Офис 331