

Trench gate field-stop IGBT, V series 600 V, 20 A very high speed

Datasheet - production data

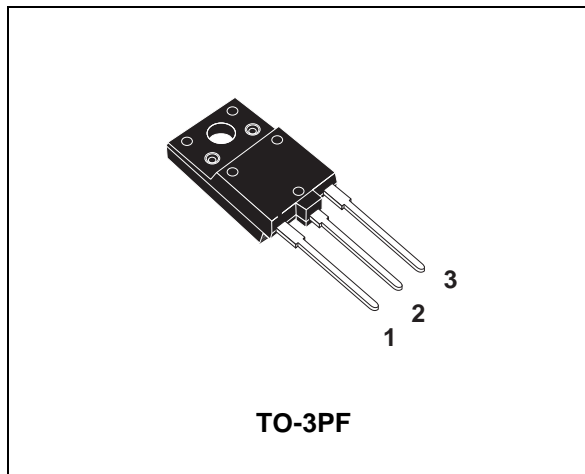
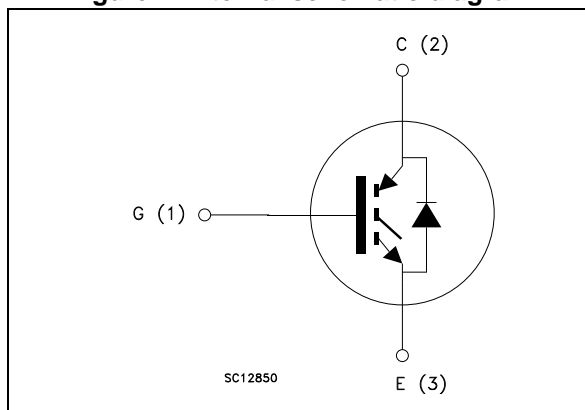

Figure 1. Internal schematic diagram



Features

- Maximum junction temperature: $T_J = 175\text{ }^\circ\text{C}$
- Very high speed switching series
- Tail-less switching off
- $V_{CE(sat)} = 1.8\text{ V (typ.) @ } I_C = 20\text{ A}$
- Tight parameters distribution
- Safe paralleling
- Low thermal resistance
- Very fast soft recovery antiparallel diode
- Lead free package

Applications

- Photovoltaic inverters
- Uninterruptible power supply
- Welding
- Power factor correction
- Very high frequency converters

Description

This device is an IGBT developed using an advanced proprietary trench gate field-stop structure. The device is part of the V series of IGBTs, which represent an optimum compromise between conduction and switching losses to maximize the efficiency of very high frequency converters. Furthermore, a positive $V_{CE(sat)}$ temperature coefficient and very tight parameter distribution result in safer paralleling operation.

Table 1. Device summary

Order code	Marking	Package	Packaging
STGFW20V60DF	GFW20V60DF	TO-3PF	Tube

Contents

1	Electrical ratings	3
2	Electrical characteristics	4
	2.1 Electrical characteristics (curves)	6
3	Test circuits	11
4	Package mechanical data	12
5	Revision history	14

1 Electrical ratings

Table 2. Absolute maximum ratings

Symbol	Parameter	Value	Unit
V_{CES}	Collector-emitter voltage ($V_{GE} = 0$)	600	V
I_C	Continuous collector current at $T_C = 25\text{ °C}$	40	A
I_C	Continuous collector current at $T_C = 100\text{ °C}$	20	A
$I_{CP}^{(1)}$	Pulsed collector current	80	A
V_{GE}	Gate-emitter voltage	± 20	V
I_F	Continuous forward current at $T_C = 25\text{ °C}$	40	A
I_F	Continuous forward current at $T_C = 100\text{ °C}$	20	A
$I_{FP(1)}$	Pulsed forward current	80	A
P_{TOT}	Total dissipation at $T_C = 25\text{ °C}$	52	W
V_{ISO}	Insulation withstand voltage (RMS) from all three leads to external heat sink ($t = 1\text{ s}$; $T_c = 25\text{ °C}$)	3.5	kV
T_{STG}	Storage temperature range	- 55 to 150	°C
T_J	Operating junction temperature	- 55 to 175	°C

1. Pulse width limited by maximum junction temperature.

Table 3. Thermal data

Symbol	Parameter	Value	Unit
R_{thJC}	Thermal resistance junction-case IGBT	2.9	°C/W
R_{thJC}	Thermal resistance junction-case diode	3.4	°C/W
R_{thJA}	Thermal resistance junction-ambient	50	°C/W

2 Electrical characteristics

$T_J = 25\text{ °C}$ unless otherwise specified.

Table 4. Static characteristics

Symbol	Parameter	Test conditions	Min.	Typ.	Max.	Unit
$V_{(BR)CES}$	Collector-emitter breakdown voltage ($V_{GE} = 0$)	$I_C = 2\text{ mA}$	600			V
$V_{CE(sat)}$	Collector-emitter saturation voltage	$V_{GE} = 15\text{ V}, I_C = 20\text{ A}$		1.8	2.2	V
		$V_{GE} = 15\text{ V}, I_C = 20\text{ A}$ $T_J = 125\text{ °C}$		2.15		
		$V_{GE} = 15\text{ V}, I_C = 20\text{ A}$ $T_J = 175\text{ °C}$		2.3		
V_F	Forward on-voltage	$I_F = 20\text{ A}$		1.7	2.2	V
		$I_F = 20\text{ A}, T_J = 125\text{ °C}$		1.55		V
		$I_F = 20\text{ A}, T_J = 175\text{ °C}$		1.3		V
$V_{GE(th)}$	Gate threshold voltage	$V_{CE} = V_{GE}, I_C = 1\text{ mA}$	5	6	7	V
I_{CES}	Collector cut-off current ($V_{GE} = 0$)	$V_{CE} = 600\text{ V}$			25	μA
I_{GES}	Gate-emitter leakage current ($V_{CE} = 0$)	$V_{GE} = \pm 20\text{ V}$			250	nA

Table 5. Dynamic characteristics

Symbol	Parameter	Test conditions	Min.	Typ.	Max.	Unit
C_{ies}	Input capacitance	$V_{CE} = 25\text{ V}, f = 1\text{ MHz},$ $V_{GE} = 0$	-	2800	-	pF
C_{oes}	Output capacitance		-	110	-	pF
C_{res}	Reverse transfer capacitance		-	64	-	pF
Q_g	Total gate charge	$V_{CC} = 480\text{ V}, I_C = 20\text{ A},$ $V_{GE} = 15\text{ V},$ see Figure 28	-	116	-	nC
Q_{ge}	Gate-emitter charge		-	24	-	nC
Q_{gc}	Gate-collector charge		-	50	-	nC

Table 6. IGBT switching characteristics (inductive load)

Symbol	Parameter	Test conditions	Min.	Typ.	Max.	Unit
$t_{d(on)}$	Turn-on delay time	$V_{CE} = 400\text{ V}$, $I_C = 20\text{ A}$, $V_{GE} = 15\text{ V}$, see Figure 27	-	38	-	ns
t_r	Current rise time		-	10	-	ns
$(di/dt)_{on}$	Turn-on current slope		-	1556	-	A/ μ s
$t_{d(off)}$	Turn-off delay time		-	149	-	ns
t_f	Current fall time		-	15	-	ns
$E_{on}^{(1)}$	Turn-on switching losses		-	200	-	μ J
$E_{off}^{(2)}$	Turn-off switching losses		-	130	-	μ J
E_{ts}	Total switching losses	-	330	-	μ J	
$t_{d(on)}$	Turn-on delay time	$V_{CE} = 400\text{ V}$, $I_C = 20\text{ A}$, $V_{GE} = 15\text{ V}$, $T_J = 175\text{ }^\circ\text{C}$, see Figure 27	-	37	-	ns
t_r	Current rise time		-	12	-	ns
$(di/dt)_{on}$	Turn-on current slope		-	1340	-	A/ μ s
$t_{d(off)}$	Turn-off delay time		-	150	-	ns
t_f	Current fall time		-	23	-	ns
$E_{on}^{(1)}$	Turn-on switching losses		-	430	-	μ J
$E_{off}^{(2)}$	Turn-off switching losses		-	210	-	μ J
E_{ts}	Total switching losses	-	640	-	μ J	

1. Energy losses include reverse recovery of the diode.
2. Turn-off losses include also the tail of the collector current.

Table 7. Diode switching characteristics (inductive load)

Symbol	Parameter	Test conditions	Min.	Typ.	Max.	Unit
t_{rr}	Reverse recovery time	$I_F = 20\text{ A}$, $V_R = 400\text{ V}$, $V_{GE} = 15\text{ V}$, see Figure 27 $di/dt = 1000\text{ A}/\mu\text{s}$	-	40	-	ns
Q_{rr}	Reverse recovery charge		-	320	-	nC
I_{rrm}	Reverse recovery current		-	16	-	A
dl_{rr}/dt	Peak rate of fall of reverse recovery current during t_b		-	910	-	A/ μ s
E_{rr}	Reverse recovery energy		-	115	-	μ J
t_{rr}	Reverse recovery time	$I_F = 20\text{ A}$, $V_R = 400\text{ V}$, $V_{GE} = 15\text{ V}$, $T_J = 175\text{ }^\circ\text{C}$, see Figure 27 $di/dt = 1000\text{ A}/\mu\text{s}$	-	72	-	ns
Q_{rr}	Reverse recovery charge		-	930	-	nC
I_{rrm}	Reverse recovery current		-	26	-	A
dl_{rr}/dt	Peak rate of fall of reverse recovery current during t_b		-	530	-	A/ μ s
E_{rr}	Reverse recovery energy		-	307	-	μ J

2.1 Electrical characteristics (curves)

Figure 2. Power dissipation vs. case temperature

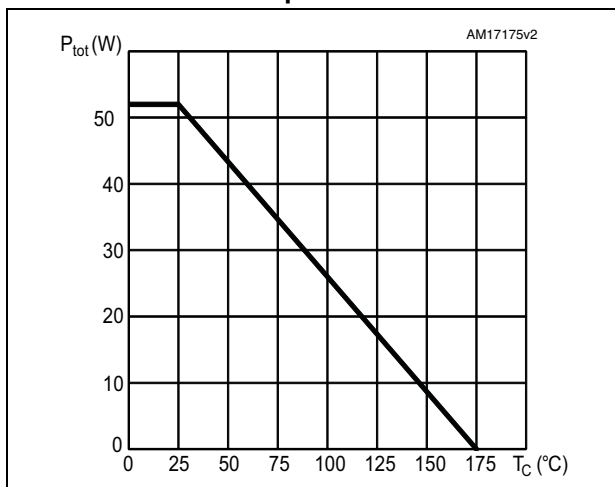

Figure 3. Collector current vs. case temperature

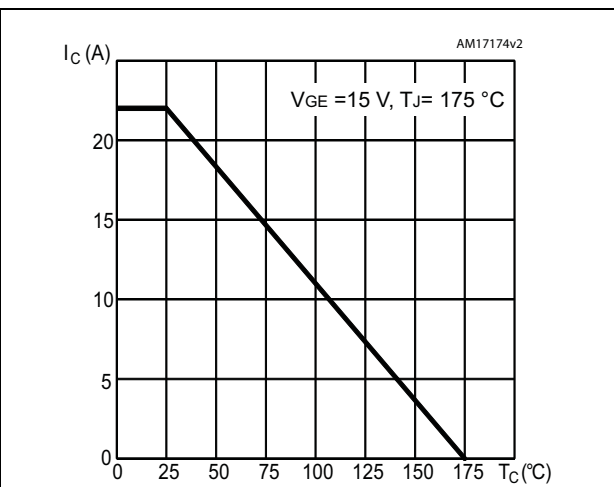

Figure 4. Output characteristics ($T_J = 25$ $^{\circ}C$)

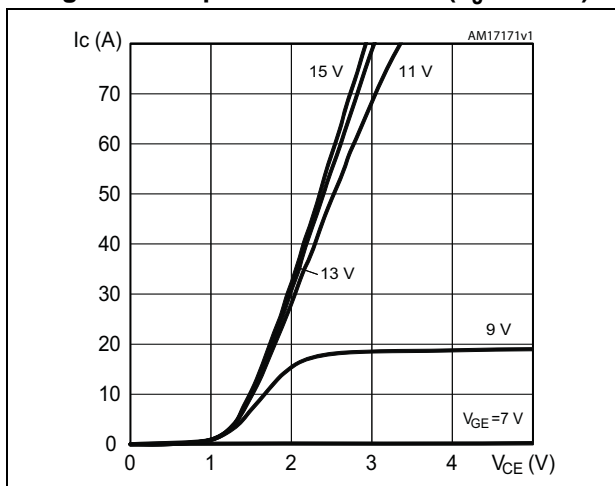

Figure 5. Output characteristics ($T_J = 175$ $^{\circ}C$)

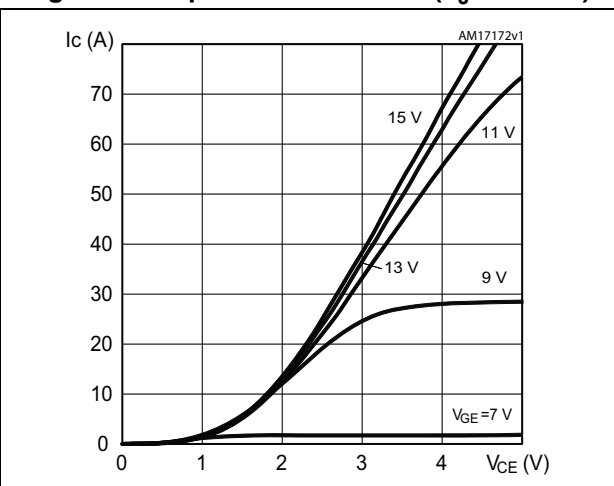

Figure 6. $V_{CE(SAT)}$ vs. junction temperature

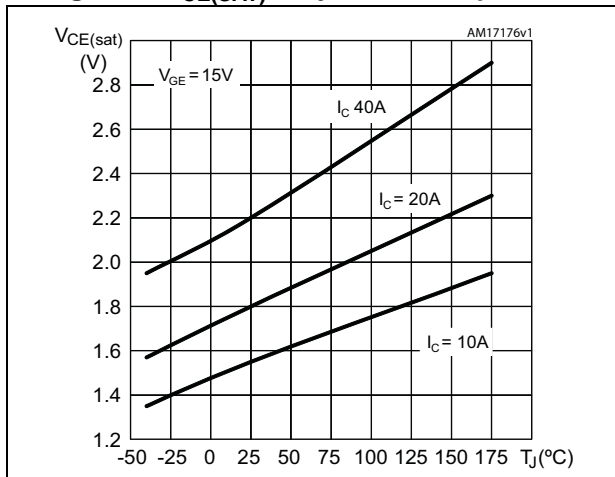

Figure 7. $V_{CE(SAT)}$ vs. collector current

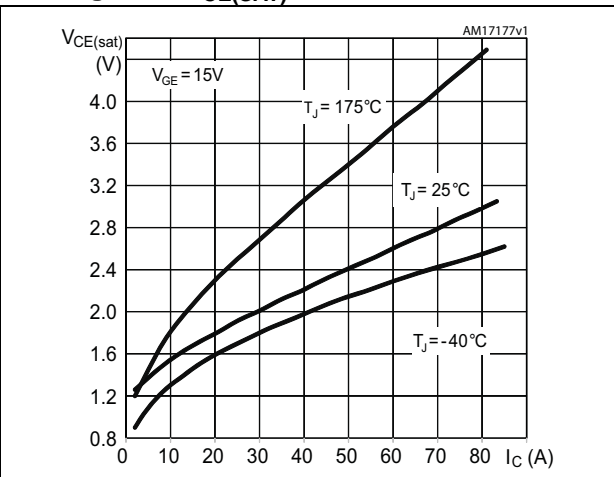

Figure 8. Transfer characteristics

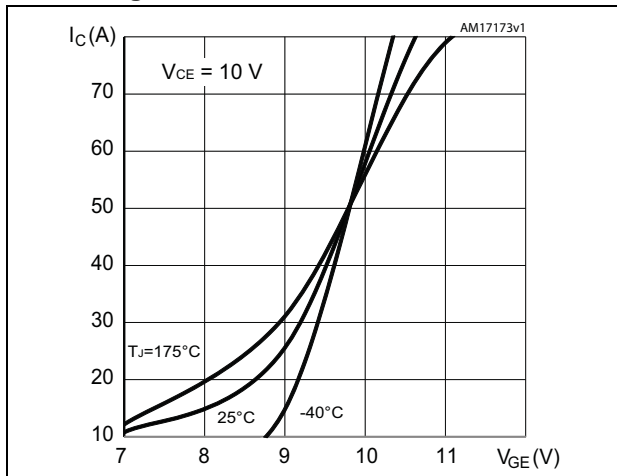

Figure 9. Diode V_F vs. forward current

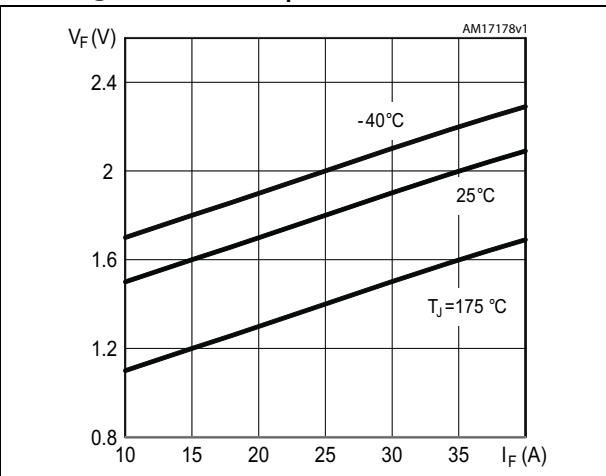

Figure 10. Normalized $V_{GE(th)}$ vs. junction temperature

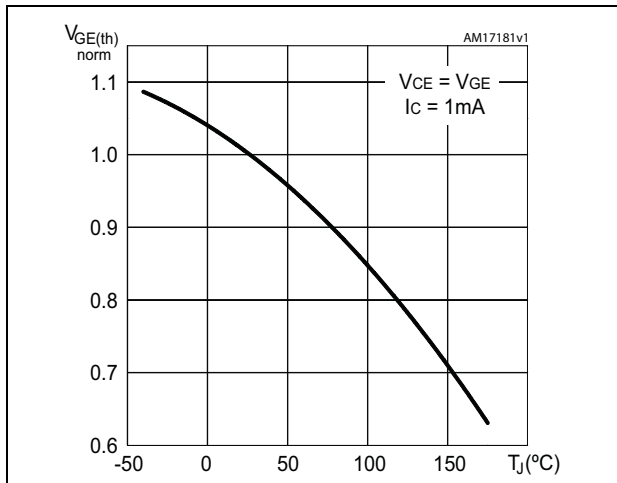

Figure 11. Normalized $V_{(BR)CES}$ vs. junction temperature

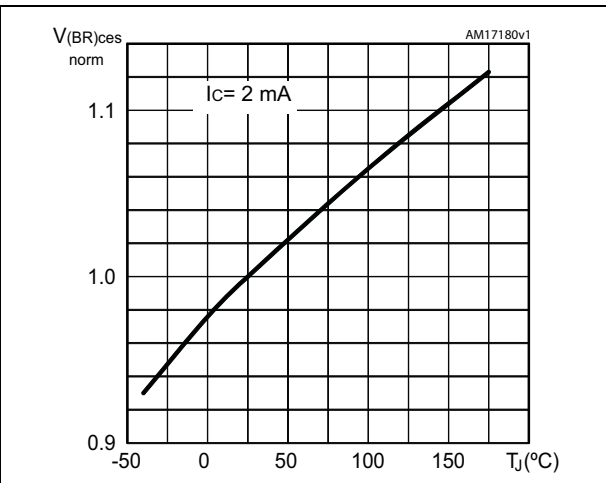

Figure 12. Capacitance variations

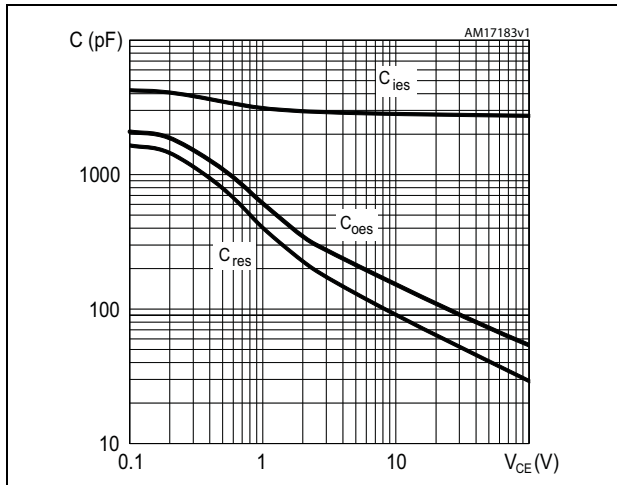

Figure 13. Gate charge vs. gate-emitter voltage

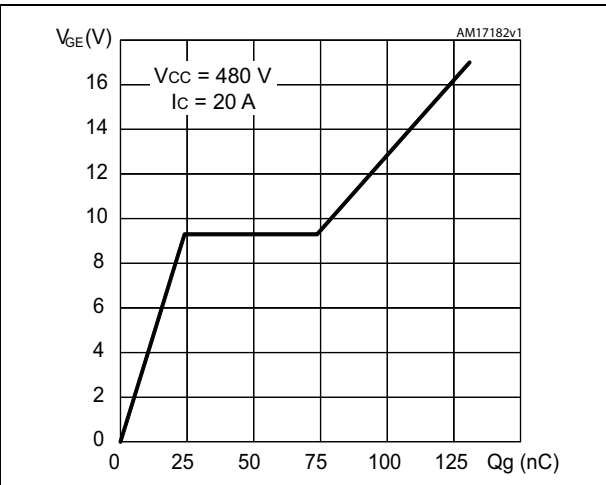

Figure 14. Switching losses vs. collector current

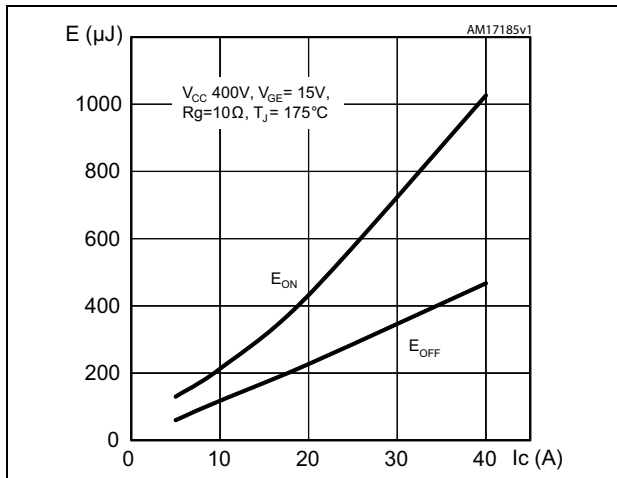

Figure 15. Switching losses vs. gate resistance

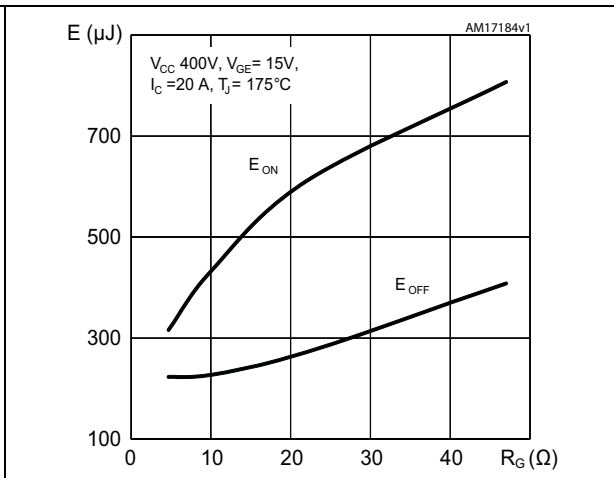

Figure 16. Switching losses vs. junction temperature

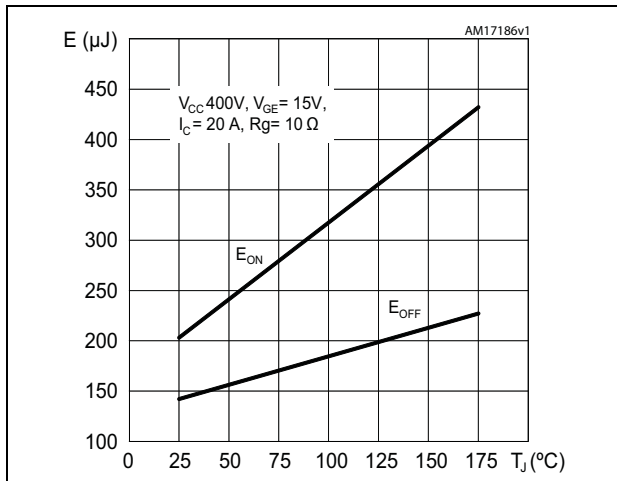

Figure 17. Switching losses vs. collector emitter voltage

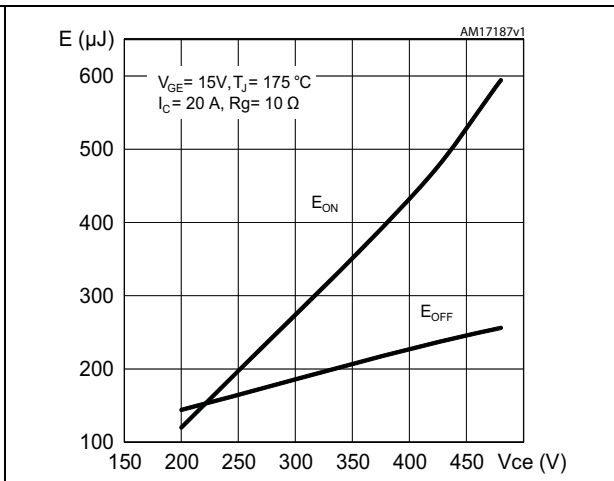

Figure 18. Switching times vs. collector current

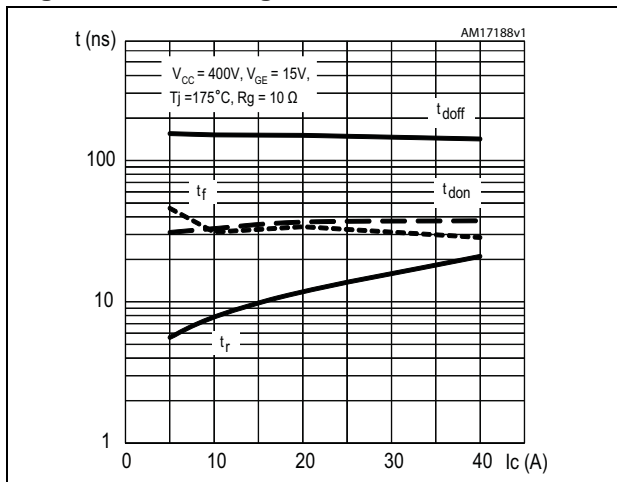

Figure 19. Switching times vs. gate resistance

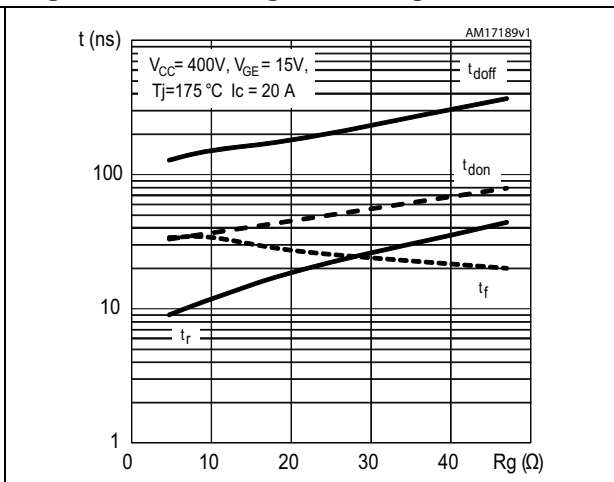

Figure 20. Reverse recovery current vs. diode current slope

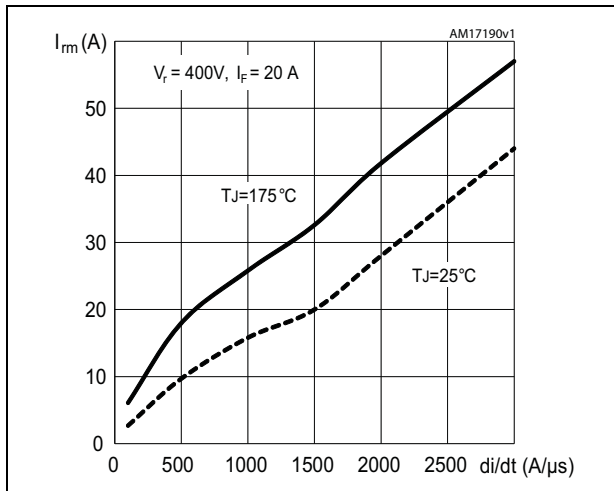

Figure 21. Reverse recovery time vs. diode current slope

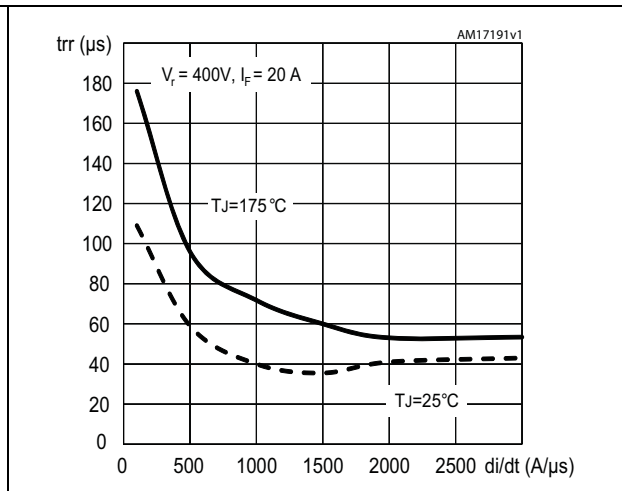

Figure 22. Reverse recovery charge vs. diode current slope

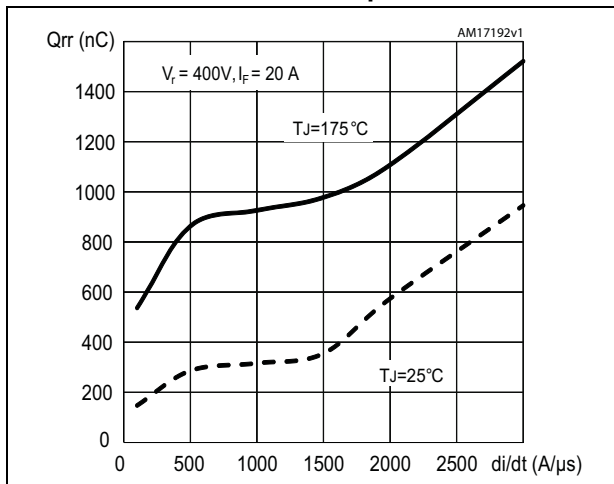

Figure 23. Reverse recovery energy vs. diode current slope

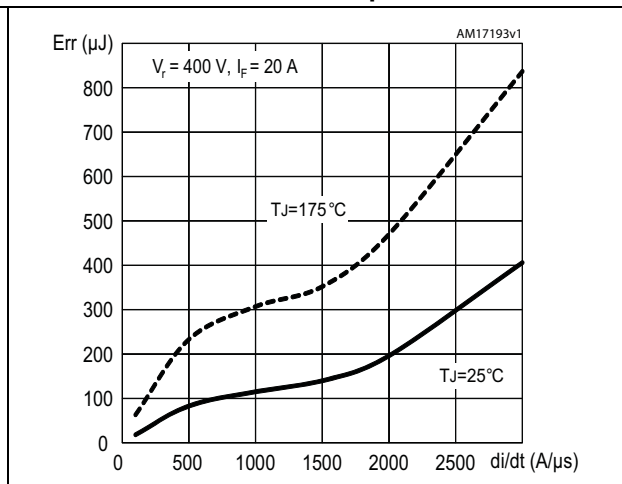

Figure 24. Safe operating area

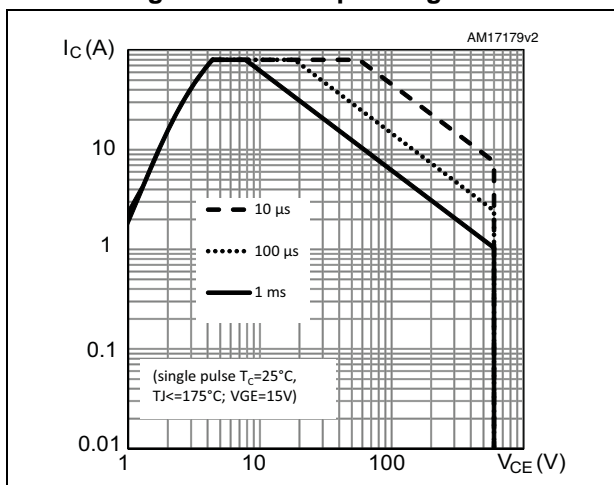

Figure 25. Thermal data for IGBT

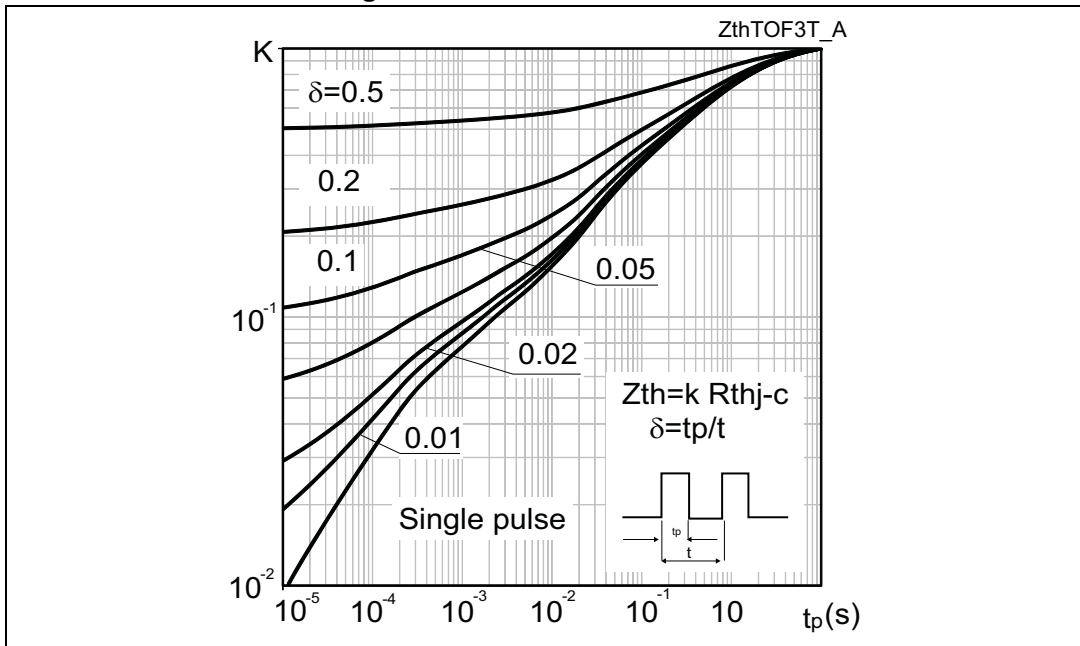
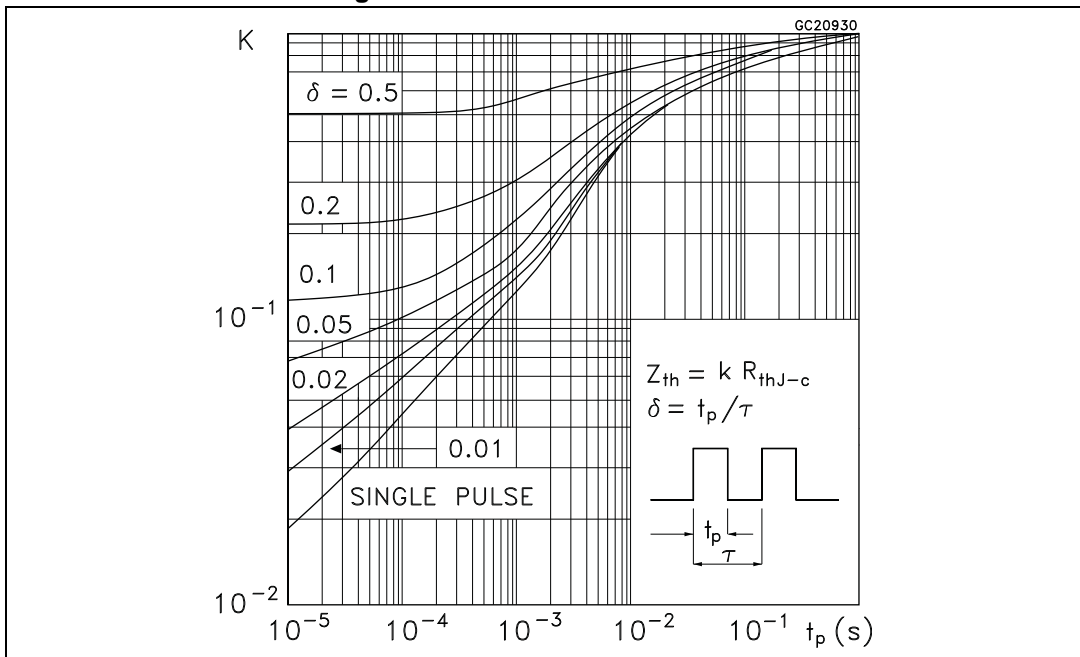
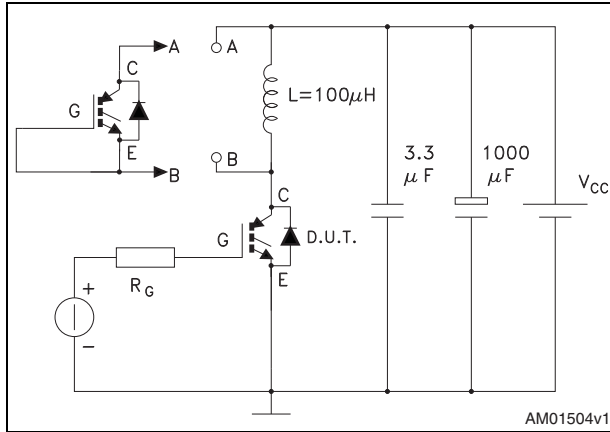

Figure 26. Thermal data for diode



3 Test circuits

Figure 27. Test circuit for inductive load switching



AM01504v1

Figure 28. Gate charge test circuit

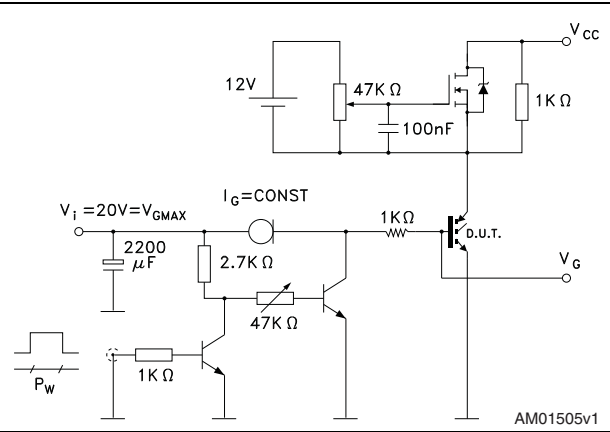

AM01505v1

Figure 29. Switching waveform

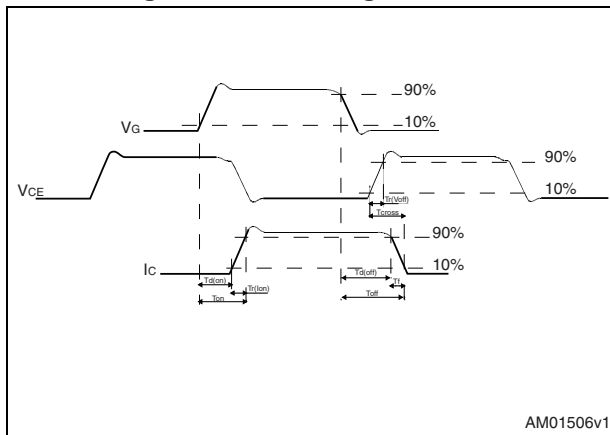

AM01506v1

Figure 30. Diode recovery time waveform

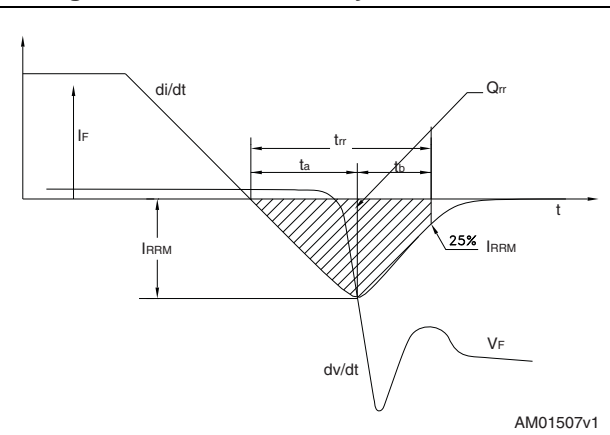

AM01507v1

4 Package mechanical data

In order to meet environmental requirements, ST offers these devices in different grades of ECOPACK® packages, depending on their level of environmental compliance. ECOPACK® specifications, grade definitions and product status are available at: www.st.com. ECOPACK is an ST trademark.

Figure 31. TO-3PF drawing

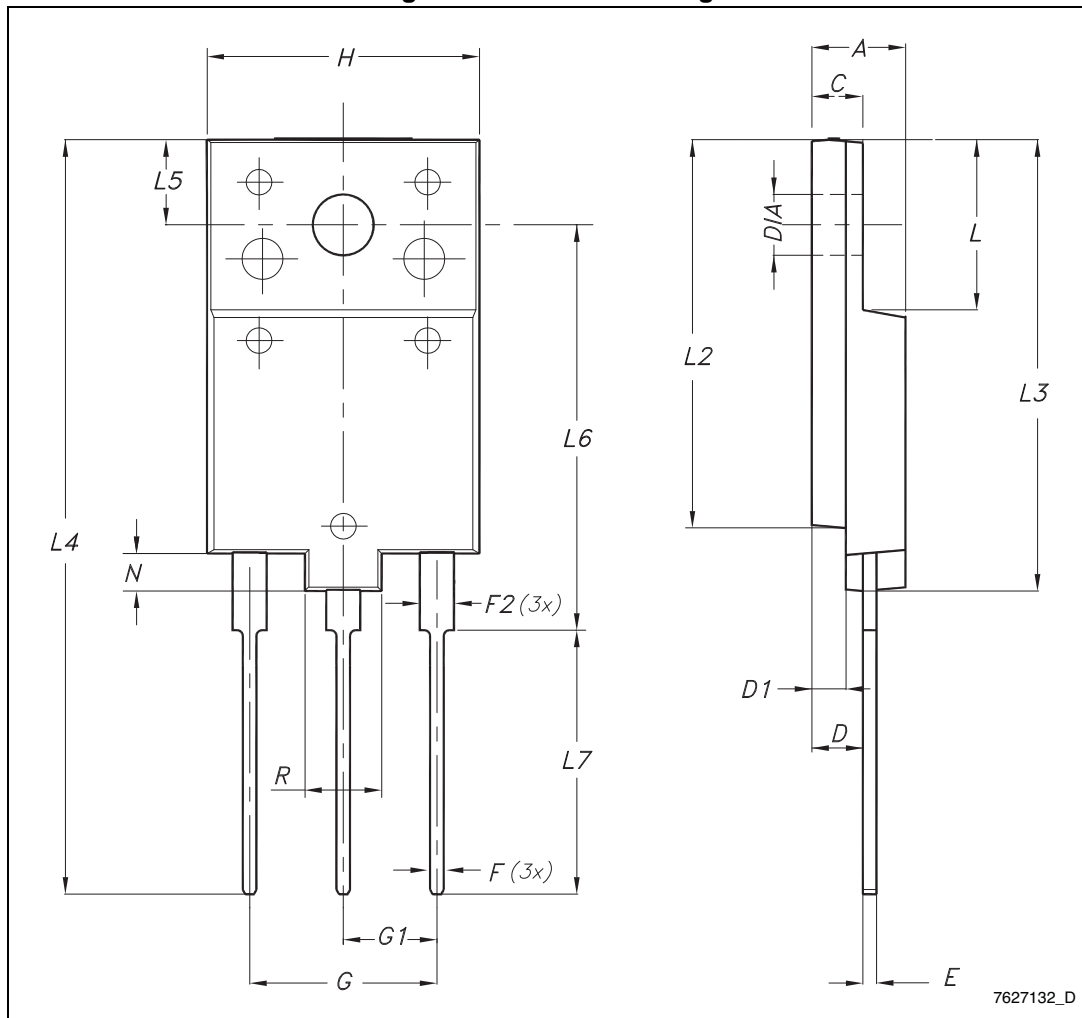

Table 8. TO-3PF mechanical data

Dim.	mm		
	Min.	Typ.	Max.
A	5.30		5.70
C	2.80		3.20
D	3.10		3.50
D1	1.80		2.20
E	0.80		1.10
F	0.65		0.95
F2	1.80		2.20
G	10.30		11.50
G1		5.45	
H	15.30		15.70
L	9.80	10	10.20
L2	22.80		23.20
L3	26.30		26.70
L4	43.20		44.40
L5	4.30		4.70
L6	24.30		24.70
L7	14.60		15
N	1.80		2.20
R	3.80		4.20
Dia	3.40		3.80

5 Revision history

Table 9. Document revision history

Date	Revision	Changes
28-Mar-2014	1	Initial release.

Please Read Carefully:

Information in this document is provided solely in connection with ST products. STMicroelectronics NV and its subsidiaries ("ST") reserve the right to make changes, corrections, modifications or improvements, to this document, and the products and services described herein at any time, without notice.

All ST products are sold pursuant to ST's terms and conditions of sale.

Purchasers are solely responsible for the choice, selection and use of the ST products and services described herein, and ST assumes no liability whatsoever relating to the choice, selection or use of the ST products and services described herein.

No license, express or implied, by estoppel or otherwise, to any intellectual property rights is granted under this document. If any part of this document refers to any third party products or services it shall not be deemed a license grant by ST for the use of such third party products or services, or any intellectual property contained therein or considered as a warranty covering the use in any manner whatsoever of such third party products or services or any intellectual property contained therein.

UNLESS OTHERWISE SET FORTH IN ST'S TERMS AND CONDITIONS OF SALE ST DISCLAIMS ANY EXPRESS OR IMPLIED WARRANTY WITH RESPECT TO THE USE AND/OR SALE OF ST PRODUCTS INCLUDING WITHOUT LIMITATION IMPLIED WARRANTIES OF MERCHANTABILITY, FITNESS FOR A PARTICULAR PURPOSE (AND THEIR EQUIVALENTS UNDER THE LAWS OF ANY JURISDICTION), OR INFRINGEMENT OF ANY PATENT, COPYRIGHT OR OTHER INTELLECTUAL PROPERTY RIGHT.

ST PRODUCTS ARE NOT DESIGNED OR AUTHORIZED FOR USE IN: (A) SAFETY CRITICAL APPLICATIONS SUCH AS LIFE SUPPORTING, ACTIVE IMPLANTED DEVICES OR SYSTEMS WITH PRODUCT FUNCTIONAL SAFETY REQUIREMENTS; (B) AERONAUTIC APPLICATIONS; (C) AUTOMOTIVE APPLICATIONS OR ENVIRONMENTS, AND/OR (D) AEROSPACE APPLICATIONS OR ENVIRONMENTS. WHERE ST PRODUCTS ARE NOT DESIGNED FOR SUCH USE, THE PURCHASER SHALL USE PRODUCTS AT PURCHASER'S SOLE RISK, EVEN IF ST HAS BEEN INFORMED IN WRITING OF SUCH USAGE, UNLESS A PRODUCT IS EXPRESSLY DESIGNATED BY ST AS BEING INTENDED FOR "AUTOMOTIVE, AUTOMOTIVE SAFETY OR MEDICAL" INDUSTRY DOMAINS ACCORDING TO ST PRODUCT DESIGN SPECIFICATIONS. PRODUCTS FORMALLY ESCC, QML OR JAN QUALIFIED ARE DEEMED SUITABLE FOR USE IN AEROSPACE BY THE CORRESPONDING GOVERNMENTAL AGENCY.

Resale of ST products with provisions different from the statements and/or technical features set forth in this document shall immediately void any warranty granted by ST for the ST product or service described herein and shall not create or extend in any manner whatsoever, any liability of ST.

ST and the ST logo are trademarks or registered trademarks of ST in various countries.

Information in this document supersedes and replaces all information previously supplied.

The ST logo is a registered trademark of STMicroelectronics. All other names are the property of their respective owners.

© 2014 STMicroelectronics - All rights reserved

STMicroelectronics group of companies

Australia - Belgium - Brazil - Canada - China - Czech Republic - Finland - France - Germany - Hong Kong - India - Israel - Italy - Japan - Malaysia - Malta - Morocco - Philippines - Singapore - Spain - Sweden - Switzerland - United Kingdom - United States of America

www.st.com



Стандарт Электрон Связь

Мы молодая и активно развивающаяся компания в области поставок электронных компонентов. Мы поставляем электронные компоненты отечественного и импортного производства напрямую от производителей и с крупнейших складов мира.

Благодаря сотрудничеству с мировыми поставщиками мы осуществляем комплексные и плановые поставки широчайшего спектра электронных компонентов.

Собственная эффективная логистика и склад в обеспечивает надежную поставку продукции в точно указанные сроки по всей России.

Мы осуществляем техническую поддержку нашим клиентам и предпродажную проверку качества продукции. На все поставляемые продукты мы предоставляем гарантию .

Осуществляем поставки продукции под контролем ВП МО РФ на предприятия военно-промышленного комплекса России , а также работаем в рамках 275 ФЗ с открытием отдельных счетов в уполномоченном банке. Система менеджмента качества компании соответствует требованиям ГОСТ ISO 9001.

Минимальные сроки поставки, гибкие цены, неограниченный ассортимент и индивидуальный подход к клиентам являются основой для выстраивания долгосрочного и эффективного сотрудничества с предприятиями радиоэлектронной промышленности, предприятиями ВПК и научно-исследовательскими институтами России.

С нами вы становитесь еще успешнее!

Наши контакты:

Телефон: +7 812 627 14 35

Электронная почта: sales@st-electron.ru

Адрес: 198099, Санкт-Петербург,
Промышленная ул, дом № 19, литера Н,
помещение 100-Н Офис 331