

LM1972 μ Pot 2-Channel 78dB Audio Attenuator with Mute

Check for Samples: [LM1972](#)

FEATURES

- 3-Wire Serial Interface
- Daisy-Chain Capability
- 104dB Mute Attenuation
- Pop and Click Free Attenuation Changes

APPLICATIONS

- Automated Studio Mixing Consoles
- Music Reproduction Systems
- Sound Reinforcement Systems
- Electronic Music (MIDI)
- Personal Computer Audio Control

KEY SPECIFICATIONS

- Total Harmonic Distortion + Noise: 0.003 % (max)
- Frequency response: 100 kHz (–3dB) (min)
- Attenuation range (excluding mute): 78 dB (typ)
- Differential attenuation: ± 0.25 dB (max)
- Signal-to-noise ratio (ref. 4 V_{rms}): 110 dB (min)
- Channel separation: 100 dB (min)

Typical Application

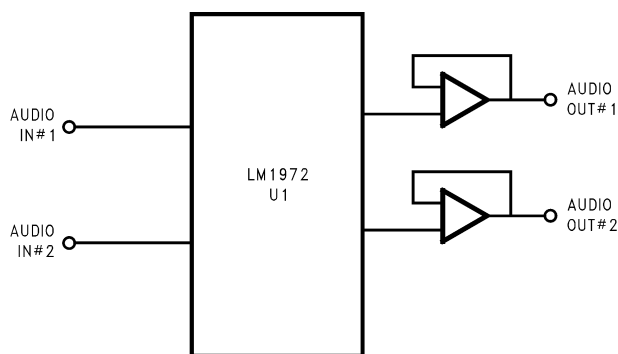

Figure 1. Typical Audio Attenuator Application Circuit

DESCRIPTION

The LM1972 is a digitally controlled 2-channel 78dB audio attenuator fabricated on a CMOS process. Each channel has attenuation steps of 0.5dB from 0dB–47.5dB, 1.0dB steps from 48dB–78dB, with a mute function attenuating 104dB. Its logarithmic attenuation curve can be customized through software to fit the desired application.

The performance of a μ Pot is demonstrated through its excellent Signal-to-Noise Ratio, extremely low (THD+N), and high channel separation. Each μ Pot contains a mute function that disconnects the input signal from the output, providing a minimum attenuation of 96dB. Transitions between any attenuation settings are pop free.

The LM1972's 3-wire serial digital interface is TTL and CMOS compatible; receiving data that selects a channel and the desired attenuation level. The Data-Out pin of the LM1972 allows multiple μ Pots to be daisy-chained together, reducing the number of enable and data lines to be routed for a given application.

Connection Diagram

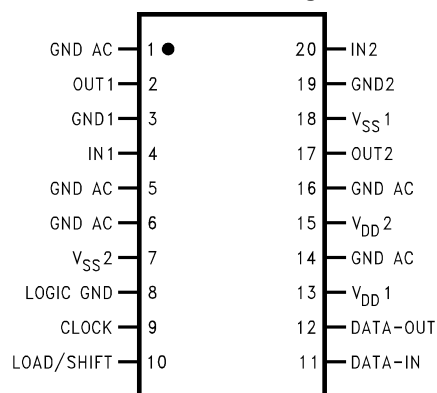

Figure 2. 20-Lead SOIC - Top View
See DW Package



Please be aware that an important notice concerning availability, standard warranty, and use in critical applications of Texas Instruments semiconductor products and disclaimers thereto appears at the end of this data sheet.

All trademarks are the property of their respective owners.



These devices have limited built-in ESD protection. The leads should be shorted together or the device placed in conductive foam during storage or handling to prevent electrostatic damage to the MOS gates.

Absolute Maximum Ratings ⁽¹⁾⁽²⁾⁽³⁾

Supply Voltage ($V_{DD}-V_{SS}$)		15V
Voltage at Any Pin		$V_{SS} - 0.2V$ to $V_{DD} + 0.2V$
Power Dissipation ⁽⁴⁾		150 mW
ESD Susceptibility ⁽⁵⁾		2000V
Junction Temperature		150°C
Soldering Information	DW Package (10 sec.)	+260°C
Storage Temperature		-65°C to +150°C

- (1) All voltages are measured with respect to GND pins (1, 3, 5, 6, 14, 16, 19), unless otherwise specified.
- (2) *Absolute Maximum Ratings* indicate limits beyond which damage to the device may occur. Operating Ratings indicate conditions for which the device is functional. *Electrical Characteristics* state DC and AC electrical specifications under particular test conditions. This assumes that the device is within the Operating Ratings. The typical value is a good indication of device performance.
- (3) If Military/Aerospace specified devices are required, please contact the Texas Instruments Sales Office/ Distributors for availability and specifications.
- (4) The maximum power dissipation must be derated at elevated temperatures and is dictated by T_{JMAX} , θ_{JA} , and the ambient temperature T_A . The maximum allowable power dissipation is $PD = (T_{JMAX} - T_A)/\theta_{JA}$ or the number given in the Absolute Maximum Ratings, whichever is lower. For the LM1972, $T_{JMAX} = +150^\circ\text{C}$, and the typical junction-to-ambient thermal resistance, when board mounted, is 65°C/W .
- (5) Human body model, 100 pF discharged through a 1.5 k Ω resistor.

Operating Ratings ⁽¹⁾⁽²⁾

		T_{MIN}	T_A	T_{MAX}
Temperature Range	$T_{MIN} \leq T_A \leq T_{MAX}$	0°C	$\leq T_A$	$\leq +70^\circ\text{C}$
Supply Voltage ($V_{DD} - V_{SS}$)		4.5V to 12V		

- (1) All voltages are measured with respect to GND pins (1, 3, 5, 6, 14, 16, 19), unless otherwise specified.
- (2) *Absolute Maximum Ratings* indicate limits beyond which damage to the device may occur. Operating Ratings indicate conditions for which the device is functional. *Electrical Characteristics* state DC and AC electrical specifications under particular test conditions. This assumes that the device is within the Operating Ratings. The typical value is a good indication of device performance.

Electrical Characteristics ⁽¹⁾⁽²⁾

The following specifications apply for all channels with $V_{DD} = +6V$, $V_{SS} = -6V$, $V_{IN} = 5.5$ Vpk, and $f = 1$ kHz, unless otherwise specified. Limits apply for $T_A = 25^\circ C$. Digital inputs are TTL and CMOS compatible.

Symbol	Parameter	Conditions	LM1972		Units (Limits)
			Typical ⁽³⁾	Limit ⁽⁴⁾	
I_S	Supply Current	Inputs are AC Grounded	2	4	mA (max)
THD+N	Total Harmonic Distortion plus Noise	$V_{IN} = 0.5$ Vpk @ 0dB Attenuation	0.0008	0.003	% (max)
XTalk	Crosstalk (Channel Separation)	0dB Attenuation for V_{IN} V_{CH} measured @ -78dB	110	100	dB (min)
SNR	Signal-to-Noise Ratio	Inputs are AC Grounded @ -12dB Attenuation A-Weighted	120	110	dB (min)
A_M	Mute Attenuation		104	96	dB (min)
	Attenuation Step Size Error	0dB to -47.5dB		±0.05	dB (max)
		-48dB to -78dB		±0.25	dB (max)
	Absolute Attenuation Error	Attenuation @ 0dB	0.03	0.5	dB (min)
		Attenuation @ -20dB	19.8	19.0	dB (min)
		Attenuation @ -40dB	39.5	38.5	dB (min)
Attenuation @ -60dB		59.3	57.5	dB (min)	
Attenuation @ -78dB		76.3	74.5	dB (min)	
Channel-to-Channel Attenuation Tracking Error	Attenuation @ 0dB, -20dB, -40dB, -60dB		±0.5	dB (max)	
	Attenuation @ -78dB		±0.75	dB (max)	
I_{LEAK}	Analog Input Leakage Current	Inputs are AC Grounded	10.0	100	nA (max)
R_{IN}	AC Input Impedance	Pins 4, 20, $V_{IN} = 1.0$ Vpk, $f = 1$ kHz	40	20	kΩ (min)
				60	kΩ (max)
I_{IN}	Input Current	@ Pins 9, 10, 11 @ $0V < V_{IN} < 5V$	1.0	±100	nA (max)
f_{CLK}	Clock Frequency		3	2	MHz (max)
V_{IH}	High-Level Input Voltage	@ Pins 9, 10, 11		2.0	V (min)
V_{IL}	Low-Level Input Voltage	@ Pins 9, 10, 11		0.8	V (max)
	Data-Out Levels (Pin 12)	$V_{DD}=6V$, $V_{SS}=0V$		0.1	V (max)
				5.9	V (min)

- (1) All voltages are measured with respect to GND pins (1, 3, 5, 6, 14, 16, 19), unless otherwise specified.
- (2) *Absolute Maximum Ratings* indicate limits beyond which damage to the device may occur. Operating Ratings indicate conditions for which the device is functional. *Electrical Characteristics* state DC and AC electrical specifications under particular test conditions. This assumes that the device is within the Operating Ratings. The typical value is a good indication of device performance.
- (3) Typicals are measured at $25^\circ C$ and represent the parametric norm.
- (4) Limits are specified to Texas Instrument's AOQL (Average Output Quality Level).

Timing Diagram

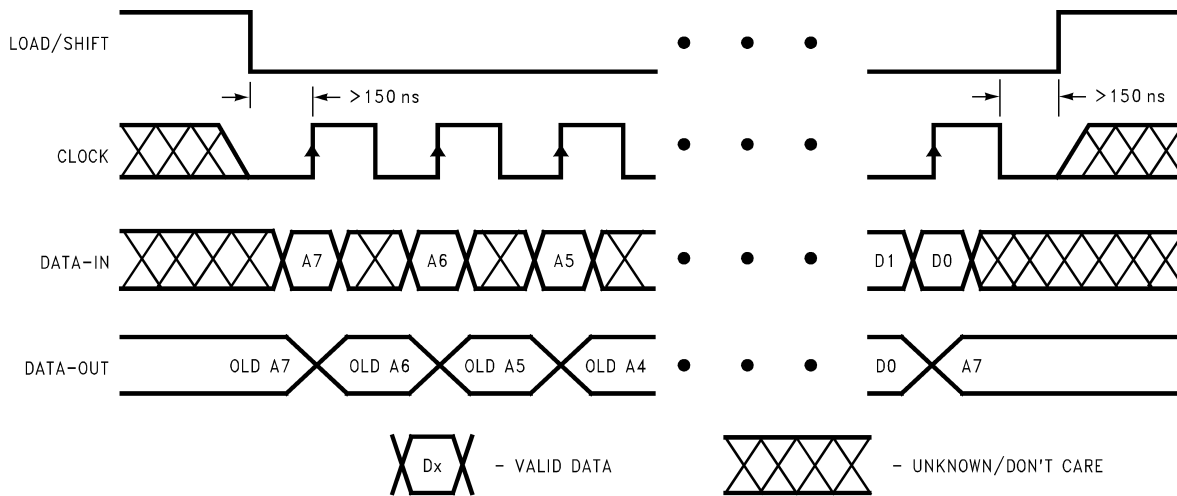

Figure 3. Timing Diagram

PIN DESCRIPTIONS

Signal Ground (3, 19): Each input has its own independent ground, GND1 and GND2.

Signal Input (4, 20): There are 2 independent signal inputs, IN1 and IN2.

Signal Output (2, 17): There are 2 independent signal outputs, OUT1 and OUT2.

Voltage Supply (13, 15): Positive voltage supply pins, V_{DD1} and V_{DD2} .

Voltage Supply (7, 18): Negative voltage supply pins, V_{SS1} and V_{SS2} . To be tied to ground in a single supply configuration.

AC Ground (1, 5, 6, 14, 16): These five pins are not physically connected to the die in any way (i.e., No bondwires). These pins must be AC grounded to prevent signal coupling between any of the pins nearby. Pin 14 should be connected to pins 13 and 15 for ease of wiring and the best isolation, as an example.

Logic Ground (8): Digital signal ground for the interface lines; CLOCK, LOAD/SHIFT, DATA-IN and DATA-OUT.

Clock (9): The clock input accepts a TTL or CMOS level signal. The clock input is used to load data into the internal shift register on the rising edge of the input clock waveform.

Load/Shift (10): The load/shift input accepts a TTL or CMOS level signal. This is the enable pin of the device, allowing data to be clocked in while this input is low (0V).

Data-In (11): The data-in input accepts a TTL or CMOS level signal. This pin is used to accept serial data from a microcontroller that will be latched and decoded to change a channel's attenuation level.

Data-Out (12): This pin is used in daisy-chain mode where more than one μ Pot is controlled via the same data line. As the data is clocked into the chain from the μ C, the preceding data in the shift register is shifted out the DATA-OUT pin to the next μ Pot in the chain or to ground if it is the last μ Pot in the chain. The LOAD/SHIFT line goes high once all of the new data has been shifted into each of its respective registers.

Connection Diagram

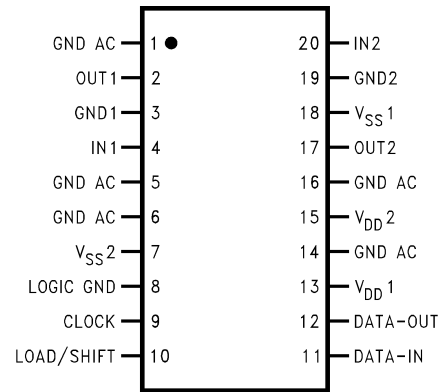

Typical Performance Characteristics

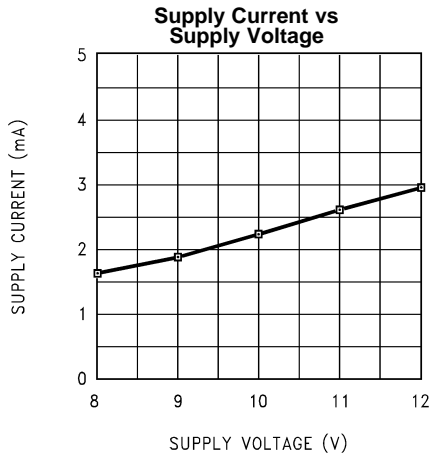

Figure 4.

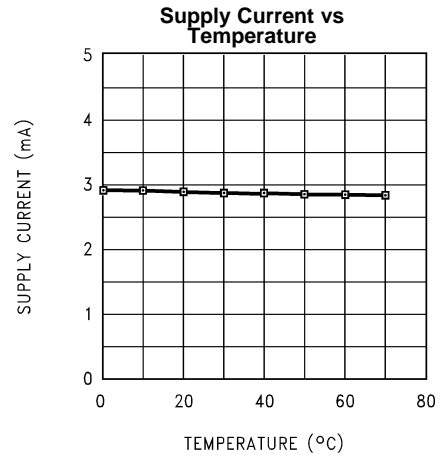

Figure 5.

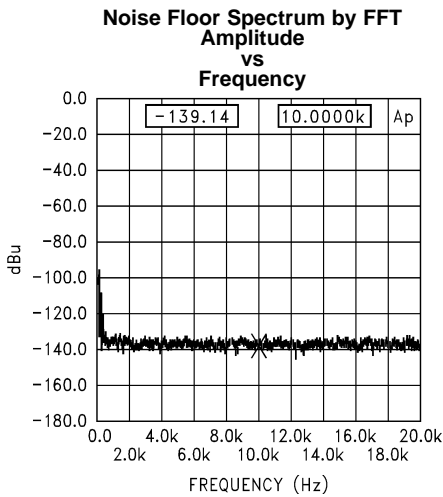

Figure 6.

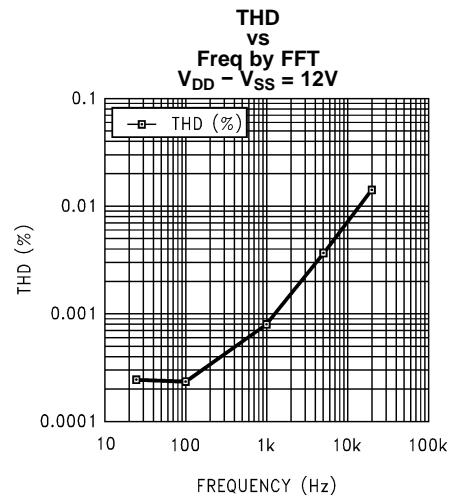

Figure 7.

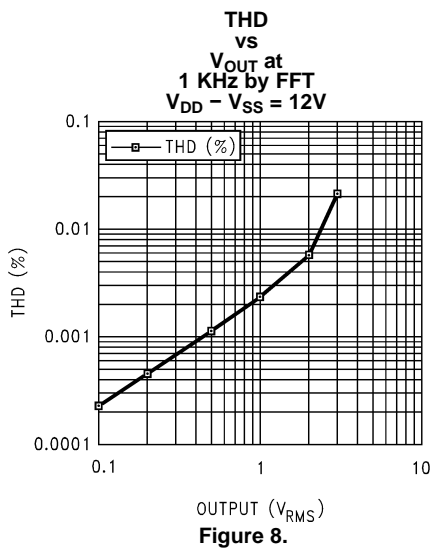

Figure 8.

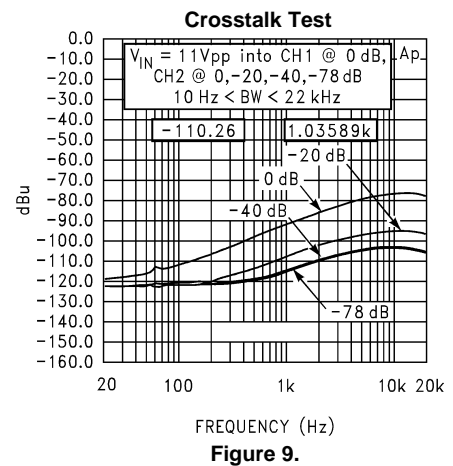

Figure 9.

Typical Performance Characteristics (continued)

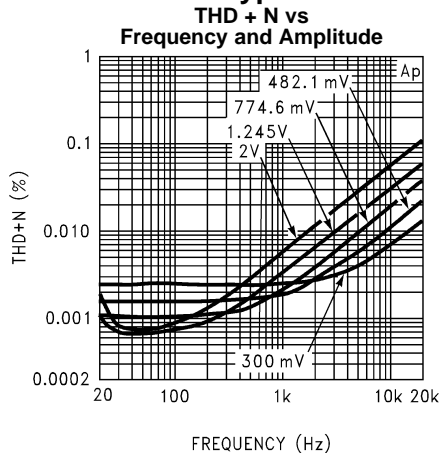

Figure 10.

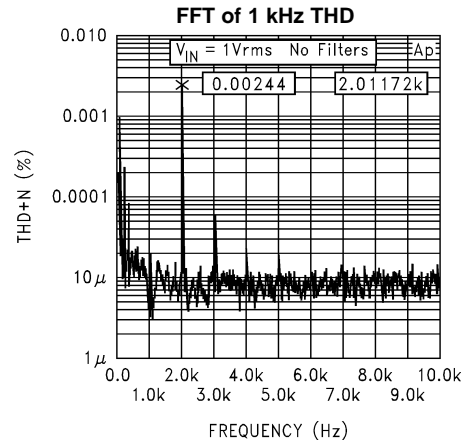

Figure 11.

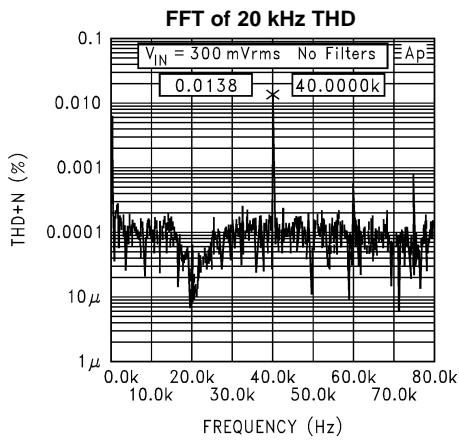

Figure 12.

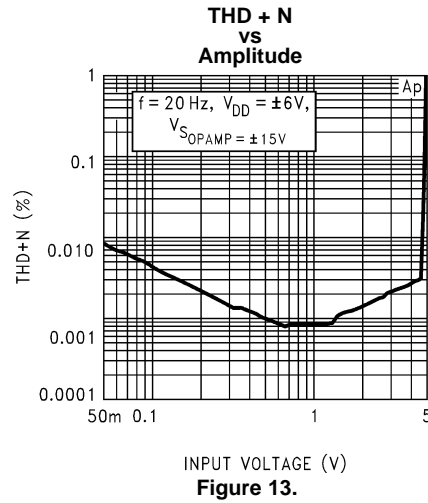

Figure 13.

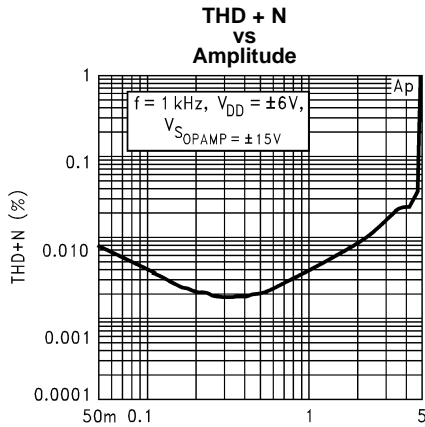

Figure 14.

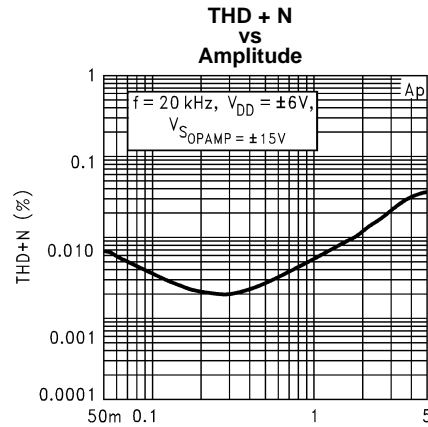

Figure 15.

APPLICATION INFORMATION

ATTENUATION STEP SCHEME

The fundamental attenuation step scheme for the LM1972 μ Pot is shown in Figure 16. This attenuation step scheme, however, can be changed through programming techniques to fit different application requirements. One such example would be a constant logarithmic attenuation scheme of 1dB steps for a panning function as shown in Figure 17. The only restriction to the customization of attenuation schemes are the given attenuation levels and their corresponding data bits shown in Table 1. The device will change attenuation levels only when a channel address is recognized. When recognized, the attenuation level will be changed corresponding to the data bits shown in Table 1. As shown in Figure 19, an LM1972 can be configured as a panning control which separates the mono signal into left and right channels. This circuit may utilize the fundamental attenuation scheme of the LM1972 or be programmed to provide a constant 1dB logarithmic attenuation scheme as shown in Figure 17.

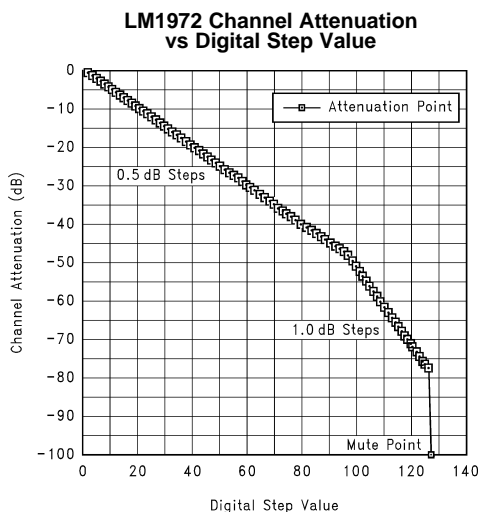

Figure 16. LM1972 Attenuation Step Scheme

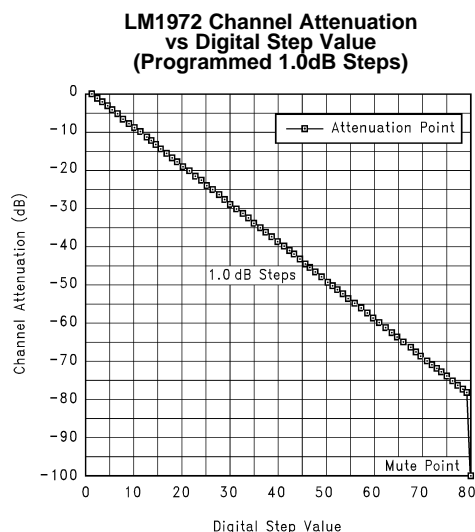

Figure 17. LM1972 1.0dB
Attenuation Step Scheme

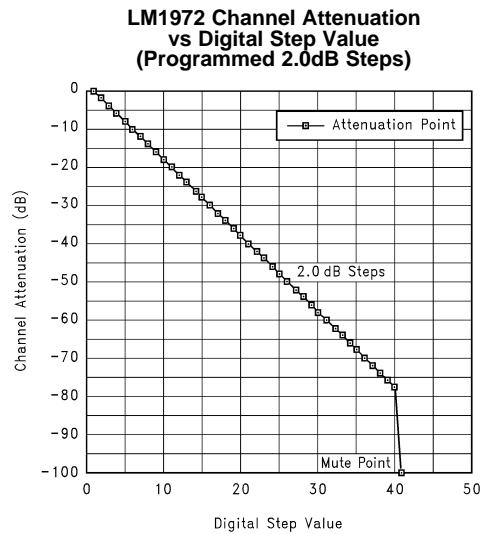

Figure 18. LM1972 2.0dB Attenuation Step Scheme

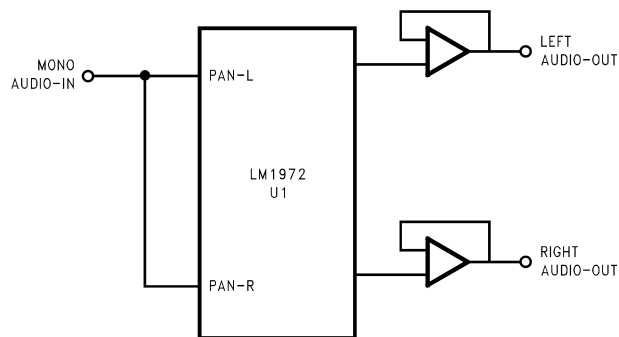

Figure 19. Mono Panning Circuit

INPUT IMPEDANCE

The input impedance of a μ Pot is constant at a nominal 40 k Ω . To eliminate any unwanted DC components from propagating through the device it is common to use 1 μ F input coupling caps. This is not necessary, however, if the dc offset from the previous stage is negligible. For higher performance systems, input coupling caps are preferred.

OUTPUT IMPEDANCE

The output of a μ Pot varies typically between 25 k Ω and 35 k Ω and changes nonlinearly with step changes. Since a μ Pot is made up of a resistor ladder network with a logarithmic attenuation, the output impedance is nonlinear. Due to this configuration, a μ Pot cannot be considered as a linear potentiometer, but can be considered only as a logarithmic attenuator.

It should be noted that the linearity of a μ Pot cannot be measured directly without a buffer because the input impedance of most measurement systems is not high enough to provide the required accuracy. Due to the low impedance of the measurement system, the output of the μ Pot would be loaded down and an incorrect reading will result. To prevent loading from occurring, a JFET input op amp should be used as the buffer/amplifier. The performance of a μ Pot is limited only by the performance of the external buffer/amplifier.

MUTE FUNCTION

One major feature of a μ Pot is its ability to mute the input signal to an attenuation level of 104dB as shown in [Figure 16](#). This is accomplished internally by physically isolating the output from the input while also grounding the output pin through approximately 2 k Ω .

The mute function is obtained during power-up of the device or by sending any binary data of 01111111 and above (to 11111111) serially to the device. The device may be placed into mute from a previous attenuation setting by sending any of the above data. This allows the designer to place a mute button onto his system which could cause a microcontroller to send the appropriate data to a μ Pot and thus mute any or all channels. Since this function is achieved through software, the designer has a great amount of flexibility in configuring the system.

DC INPUTS

Although the μ Pot was designed to be used as an attenuator for signals within the audio spectrum, the device is capable of tracking an input DC voltage. The device will track DC voltages to a diode drop above each supply rail.

One point to remember about DC tracking is that with a buffer at the output of the μ Pot, the resolution of DC tracking will depend upon the gain configuration of that output buffer and its supply voltage. It should also be remembered that the output buffer's supply voltage does not have to be the same as the μ Pot's supply voltage. This could allow for more resolution when DC tracking.

SERIAL DATA FORMAT

The LM1972 uses a 3-wire serial communication format that is easily controlled by a microcontroller. The timing for the 3-wire set, comprised of DATA-IN, CLOCK, and LOAD/SHIFT is shown in [Figure 3](#). [Figure 22](#) exhibits in block diagram form how the digital interface controls the tap switches which select the appropriate attenuation level. As depicted in [Figure 3](#), the LOAD/SHIFT line is to go low at least 150 ns before the rising edge of the first clock pulse and is to remain low throughout the transmission of each set of 16 data bits. The serial data is comprised of 8 bits for channel selection and 8 bits for attenuation setting. For both address data and attenuation setting data, the MSB is sent first and the 8 bits of address data are to be sent before the 8 bits of attenuation data. Please refer to [Figure 20](#) to confirm the serial data format transfer process.

Table 1. LM1972 Micropot Attenuator Register Set Description

MSB:	LSB	
Address Register (Byte 0)		
	0000 0000	Channel 1
	0000 0001	Channel 2
	0000 0010	Channel 3
Data Register (Byte 1)		
	Contents	Attenuation Level dB
	0000 0000	0.0
	0000 0001	0.5
	0000 0010	1.0
	0000 0011	1.5
	:: ::	::
	0001 1110	15.0
	0001 1111	15.5
	0010 0000	16.0
	0010 0001	16.5
	0010 0010	17.0
	:: ::	::
	0101 1110	47.0
	0101 1111	47.5
	0110 0000	48.0
	0110 0001	49.0
	0110 0010	50.0
	:: ::	::

Table 1. LM1972 Micropot Attenuator Register Set Description (continued)

MSB: LSB		
	0111 1100	76.0
	0111 1101	77.0
	0111 1110	78.0
	0111 1111	100.0 (Mute)
	1000 0000	100.0 (Mute)
	::
	1111 1110	100.0 (Mute)
	1111 1111	100.0 (Mute)

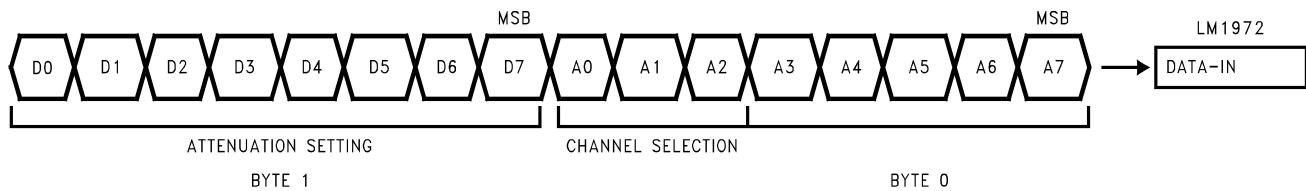

Figure 20. Serial Data Format Transfer Process

µPot SYSTEM ARCHITECTURE

The µPot's digital interface is essentially a shift register, where serial data is shifted in, latched, and then decoded. As new data is shifted into the DATA-IN pin, the previously latched data is shifted out the DATA-OUT pin. Once the data is shifted in, the LOAD/SHIFT line goes high, latching in the new data. The data is then decoded and the appropriate switch is activated to set the desired attenuation level for the selected channel. This process is continued each and every time an attenuation change is made. Each channel is updated, only, when that channel is selected for an attenuator change or the system is powered down and then back up again. When the µPot is powered up, each channel is placed into the muted mode.

µPot LADDER ARCHITECTURE

Each channel of a µPot has its own independent resistor ladder network. As shown in Figure 21, the ladder consists of multiple R1/R2 elements which make up the attenuation scheme. Within each element there are tap switches that select the appropriate attenuation level corresponding to the data bits in Table 1. It can be seen in Figure 21 that the input impedance for the channel is a constant value regardless of which tap switch is selected, while the output impedance varies according to the tap switch selected.

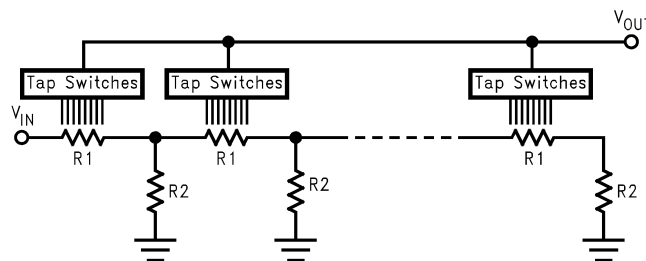

Figure 21. µPot Ladder Architecture

DIGITAL LINE COMPATIBILITY

The µPot's digital interface section is compatible with either TTL or CMOS logic due to the shift register inputs acting upon a threshold voltage of 2 diode drops or approximately 1.4V.

DIGITAL DATA-OUT PIN

The DATA-OUT pin is available for daisy-chain system configurations where multiple μ Pots will be used. The use of the daisy-chain configuration allows the system designer to use only one DATA and one LOAD/SHIFT line per chain, thus simplifying PCB trace layouts.

In order to provide the highest level of channel separation and isolate any of the signal lines from digital noise, the DATA-OUT pin should be terminated through a 2 k Ω resistor if not used. The pin may be left floating, however, any signal noise on that line may couple to adjacent lines creating higher noise specs.

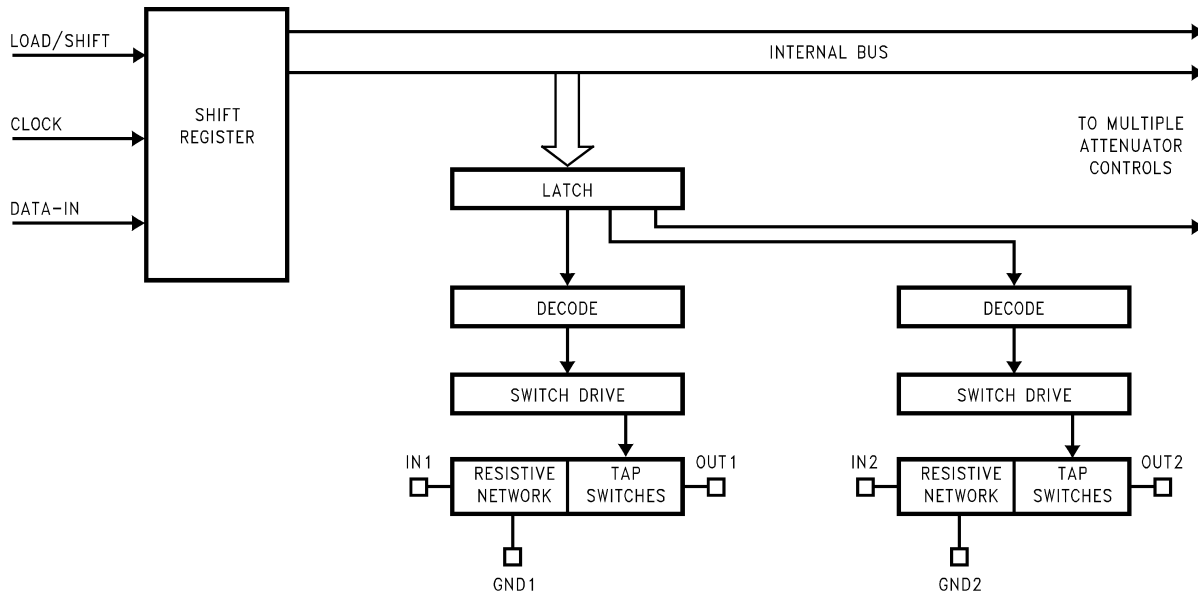

Figure 22. μ Pot System Architecture

DAISY-CHAIN CAPABILITY

Since the μ Pot's digital interface is essentially a shift register, multiple μ Pots can be programmed utilizing the same data and load/shift lines. As shown in [Figure 24](#), for an n- μ Pot daisy-chain, there are 16n bits to be shifted and loaded for the chain. The data loading sequence is the same for n- μ Pots as it is for one μ Pot. First the LOAD/SHIFT line goes low, then the data is clocked in sequentially while the preceding data in each μ Pot is shifted out the DATA-OUT pin to the next μ Pot in the chain or to ground if it is the last μ Pot in the chain. Then the LOAD/SHIFT line goes high; latching the data into each of their corresponding μ Pots. The data is then decoded according to the address (channel selection) and the appropriate tap switch controlling the attenuation level is selected.

CROSSTALK MEASUREMENTS

The crosstalk of a μ Pot as shown in the [Typical Performance Characteristics](#) was obtained by placing a signal on one channel and measuring the level at the output of another channel of the same frequency. It is important to be sure that the signal level being measured is of the same frequency such that a true indication of crosstalk may be obtained. Also, to ensure an accurate measurement, the measured channel's input should be AC grounded through a 1 μ F capacitor.

CLICKS AND POPS

So, why is that output buffer needed anyway? There are three answers to this question, all of which are important from a system point of view.

The first reason to utilize a buffer/amplifier at the output of a μ Pot is to ensure that there are no audible clicks or pops due to attenuation step changes in the device. If an on-board bipolar op amp had been used for the output stage, its requirement of a finite amount of DC bias current for operation would cause a DC voltage “pop” when the output impedance of the μ Pot changes. Again, this phenomenon is due to the fact that the output impedance of the μ Pot is changing with step changes and a bipolar amplifier requires a finite amount of DC bias current for its operation. As the impedance changes, so does the DC bias current and thus there is a DC voltage “pop”.

Secondly, the μ Pot has no drive capability, so any desired gain needs to be accomplished through a buffer/non-inverting amplifier.

Third, the output of a μ Pot needs to see a high impedance to prevent loading and subsequent linearity errors from occurring. A JFET input buffer provides a high input impedance to the output of the μ Pot so that this does not occur.

Clicks and pops can be avoided by using a JFET input buffer/amplifier such as an LF412ACN. The LF412 has a high input impedance and exhibits both a low noise floor and low THD+N throughout the audio spectrum which maintains signal integrity and linearity for the system. The performance of the system solution is entirely dependent upon the quality and performance of the JFET input buffer/amplifier.

LOGARITHMIC GAIN AMPUFIER

The μ Pot is capable of being used in the feedback loop of an amplifier, however, as stated previously, the output of the μ Pot needs to see a high impedance in order to maintain its high performance and linearity. Again, loading the output will change the values of attenuation for the device. As shown in Figure 23, a μ Pot used in the feedback loop creates a logarithmic gain amplifier. In this configuration the attenuation levels from Table 1, now become gain levels with the largest possible gain value being 78dB. For most applications 78dB of gain will cause signal clipping to occur, however, because of the μ Pot's versatility the gain can be controlled through programming such that the clipping level of the system is never obtained. An important point to remember is that when in mute mode the input is disconnected from the output. In this configuration this will place the amplifier in its open loop gain state, thus resulting in severe comparator action. Care should be taken with the programming and design of this type of circuit. To provide the best performance, a JFET input amplifier should be used.

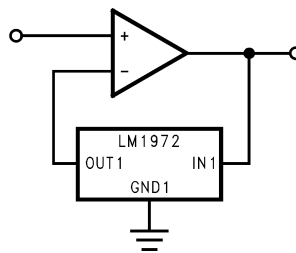

Figure 23. Digitally-Controlled Logarithmic Gain Amplifier Circuit

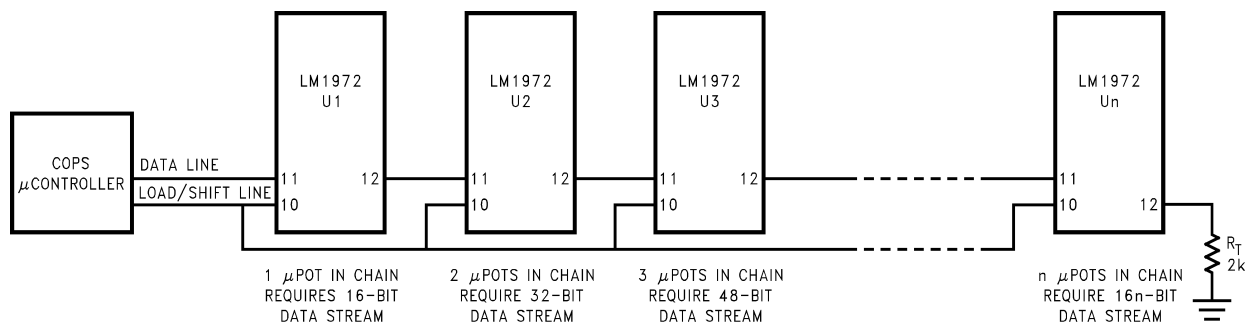

Figure 24. n- μ Pot Daisy-Chain Circuit

REVISION HISTORY

Changes from Revision C (March 2013) to Revision D	Page
• Changed layout of National Data Sheet to TI format	13

PACKAGING INFORMATION

Orderable Device	Status (1)	Package Type	Package Drawing	Pins	Package Qty	Eco Plan (2)	Lead/Ball Finish	MSL Peak Temp (3)	Op Temp (°C)	Top-Side Markings (4)	Samples
LM1972M	ACTIVE	SOIC	DW	20	36	TBD	Call TI	Call TI	0 to 70	LM1972M	Samples
LM1972M/NOPB	ACTIVE	SOIC	DW	20	36	Green (RoHS & no Sb/Br)	CU SN	Level-3-260C-168 HR	0 to 70	LM1972M	Samples
LM1972MX/NOPB	ACTIVE	SOIC	DW	20	1000	Green (RoHS & no Sb/Br)	CU SN	Level-3-260C-168 HR	0 to 70	LM1972M	Samples

(1) The marketing status values are defined as follows:

ACTIVE: Product device recommended for new designs.

LIFEBUY: TI has announced that the device will be discontinued, and a lifetime-buy period is in effect.

NRND: Not recommended for new designs. Device is in production to support existing customers, but TI does not recommend using this part in a new design.

PREVIEW: Device has been announced but is not in production. Samples may or may not be available.

OBSOLETE: TI has discontinued the production of the device.

(2) Eco Plan - The planned eco-friendly classification: Pb-Free (RoHS), Pb-Free (RoHS Exempt), or Green (RoHS & no Sb/Br) - please check <http://www.ti.com/productcontent> for the latest availability information and additional product content details.

TBD: The Pb-Free/Green conversion plan has not been defined.

Pb-Free (RoHS): TI's terms "Lead-Free" or "Pb-Free" mean semiconductor products that are compatible with the current RoHS requirements for all 6 substances, including the requirement that lead not exceed 0.1% by weight in homogeneous materials. Where designed to be soldered at high temperatures, TI Pb-Free products are suitable for use in specified lead-free processes.

Pb-Free (RoHS Exempt): This component has a RoHS exemption for either 1) lead-based flip-chip solder bumps used between the die and package, or 2) lead-based die adhesive used between the die and leadframe. The component is otherwise considered Pb-Free (RoHS compatible) as defined above.

Green (RoHS & no Sb/Br): TI defines "Green" to mean Pb-Free (RoHS compatible), and free of Bromine (Br) and Antimony (Sb) based flame retardants (Br or Sb do not exceed 0.1% by weight in homogeneous material)

(3) MSL, Peak Temp. -- The Moisture Sensitivity Level rating according to the JEDEC industry standard classifications, and peak solder temperature.

(4) Only one of markings shown within the brackets will appear on the physical device.

Important Information and Disclaimer: The information provided on this page represents TI's knowledge and belief as of the date that it is provided. TI bases its knowledge and belief on information provided by third parties, and makes no representation or warranty as to the accuracy of such information. Efforts are underway to better integrate information from third parties. TI has taken and continues to take reasonable steps to provide representative and accurate information but may not have conducted destructive testing or chemical analysis on incoming materials and chemicals. TI and TI suppliers consider certain information to be proprietary, and thus CAS numbers and other limited information may not be available for release.

In no event shall TI's liability arising out of such information exceed the total purchase price of the TI part(s) at issue in this document sold by TI to Customer on an annual basis.

TAPE AND REEL INFORMATION



QUADRANT ASSIGNMENTS FOR PIN 1 ORIENTATION IN TAPE



*All dimensions are nominal

Device	Package Type	Package Drawing	Pins	SPQ	Reel Diameter (mm)	Reel Width W1 (mm)	A0 (mm)	B0 (mm)	K0 (mm)	P1 (mm)	W (mm)	Pin1 Quadrant
LM1972MX/NOPB	SOIC	DW	20	1000	330.0	24.4	10.9	13.3	3.25	12.0	24.0	Q1

TAPE AND REEL BOX DIMENSIONS



*All dimensions are nominal

Device	Package Type	Package Drawing	Pins	SPQ	Length (mm)	Width (mm)	Height (mm)
LM1972MX/NOPB	SOIC	DW	20	1000	358.0	343.0	63.0

DW (R-PDSO-G20)

PLASTIC SMALL OUTLINE



- NOTES:
- A. All linear dimensions are in inches (millimeters). Dimensioning and tolerancing per ASME Y14.5M-1994.
 - B. This drawing is subject to change without notice.
 - C. Body dimensions do not include mold flash or protrusion not to exceed 0.006 (0,15).
 - D. Falls within JEDEC MS-013 variation AC.

IMPORTANT NOTICE

Texas Instruments Incorporated and its subsidiaries (TI) reserve the right to make corrections, enhancements, improvements and other changes to its semiconductor products and services per JESD46, latest issue, and to discontinue any product or service per JESD48, latest issue. Buyers should obtain the latest relevant information before placing orders and should verify that such information is current and complete. All semiconductor products (also referred to herein as "components") are sold subject to TI's terms and conditions of sale supplied at the time of order acknowledgment.

TI warrants performance of its components to the specifications applicable at the time of sale, in accordance with the warranty in TI's terms and conditions of sale of semiconductor products. Testing and other quality control techniques are used to the extent TI deems necessary to support this warranty. Except where mandated by applicable law, testing of all parameters of each component is not necessarily performed.

TI assumes no liability for applications assistance or the design of Buyers' products. Buyers are responsible for their products and applications using TI components. To minimize the risks associated with Buyers' products and applications, Buyers should provide adequate design and operating safeguards.

TI does not warrant or represent that any license, either express or implied, is granted under any patent right, copyright, mask work right, or other intellectual property right relating to any combination, machine, or process in which TI components or services are used. Information published by TI regarding third-party products or services does not constitute a license to use such products or services or a warranty or endorsement thereof. Use of such information may require a license from a third party under the patents or other intellectual property of the third party, or a license from TI under the patents or other intellectual property of TI.

Reproduction of significant portions of TI information in TI data books or data sheets is permissible only if reproduction is without alteration and is accompanied by all associated warranties, conditions, limitations, and notices. TI is not responsible or liable for such altered documentation. Information of third parties may be subject to additional restrictions.

Resale of TI components or services with statements different from or beyond the parameters stated by TI for that component or service voids all express and any implied warranties for the associated TI component or service and is an unfair and deceptive business practice. TI is not responsible or liable for any such statements.

Buyer acknowledges and agrees that it is solely responsible for compliance with all legal, regulatory and safety-related requirements concerning its products, and any use of TI components in its applications, notwithstanding any applications-related information or support that may be provided by TI. Buyer represents and agrees that it has all the necessary expertise to create and implement safeguards which anticipate dangerous consequences of failures, monitor failures and their consequences, lessen the likelihood of failures that might cause harm and take appropriate remedial actions. Buyer will fully indemnify TI and its representatives against any damages arising out of the use of any TI components in safety-critical applications.

In some cases, TI components may be promoted specifically to facilitate safety-related applications. With such components, TI's goal is to help enable customers to design and create their own end-product solutions that meet applicable functional safety standards and requirements. Nonetheless, such components are subject to these terms.

No TI components are authorized for use in FDA Class III (or similar life-critical medical equipment) unless authorized officers of the parties have executed a special agreement specifically governing such use.

Only those TI components which TI has specifically designated as military grade or "enhanced plastic" are designed and intended for use in military/aerospace applications or environments. Buyer acknowledges and agrees that any military or aerospace use of TI components which have **not** been so designated is solely at the Buyer's risk, and that Buyer is solely responsible for compliance with all legal and regulatory requirements in connection with such use.

TI has specifically designated certain components as meeting ISO/TS16949 requirements, mainly for automotive use. In any case of use of non-designated products, TI will not be responsible for any failure to meet ISO/TS16949.

Products

Audio	www.ti.com/audio
Amplifiers	amplifier.ti.com
Data Converters	dataconverter.ti.com
DLP® Products	www.dlp.com
DSP	dsp.ti.com
Clocks and Timers	www.ti.com/clocks
Interface	interface.ti.com
Logic	logic.ti.com
Power Mgmt	power.ti.com
Microcontrollers	microcontroller.ti.com
RFID	www.ti-rfid.com
OMAP Applications Processors	www.ti.com/omap
Wireless Connectivity	www.ti.com/wirelessconnectivity

Applications

Automotive and Transportation	www.ti.com/automotive
Communications and Telecom	www.ti.com/communications
Computers and Peripherals	www.ti.com/computers
Consumer Electronics	www.ti.com/consumer-apps
Energy and Lighting	www.ti.com/energy
Industrial	www.ti.com/industrial
Medical	www.ti.com/medical
Security	www.ti.com/security
Space, Avionics and Defense	www.ti.com/space-avionics-defense
Video and Imaging	www.ti.com/video

TI E2E Community

e2e.ti.com



Стандарт Электрон Связь

Мы молодая и активно развивающаяся компания в области поставок электронных компонентов. Мы поставляем электронные компоненты отечественного и импортного производства напрямую от производителей и с крупнейших складов мира.

Благодаря сотрудничеству с мировыми поставщиками мы осуществляем комплексные и плановые поставки широчайшего спектра электронных компонентов.

Собственная эффективная логистика и склад в обеспечивает надежную поставку продукции в точно указанные сроки по всей России.

Мы осуществляем техническую поддержку нашим клиентам и предпродажную проверку качества продукции. На все поставляемые продукты мы предоставляем гарантию .

Осуществляем поставки продукции под контролем ВП МО РФ на предприятия военно-промышленного комплекса России , а также работаем в рамках 275 ФЗ с открытием отдельных счетов в уполномоченном банке. Система менеджмента качества компании соответствует требованиям ГОСТ ISO 9001.

Минимальные сроки поставки, гибкие цены, неограниченный ассортимент и индивидуальный подход к клиентам являются основой для выстраивания долгосрочного и эффективного сотрудничества с предприятиями радиоэлектронной промышленности, предприятиями ВПК и научно-исследовательскими институтами России.

С нами вы становитесь еще успешнее!

Наши контакты:

Телефон: +7 812 627 14 35

Электронная почта: sales@st-electron.ru

Адрес: 198099, Санкт-Петербург,
Промышленная ул, дом № 19, литера Н,
помещение 100-Н Офис 331