

Inverter Grade Thyristors (Stud Version), 105 A



TO-209AC (TO-94)

FEATURES

- All diffused design
- Center amplifying gate
- Guaranteed high dV/dt
- Guaranteed high dI/dt
- High surge current capability
- Low thermal impedance
- High speed performance
- Compression bonding
- Designed and qualified for industrial level
- Material categorization: For definitions of compliance please see www.vishay.com/doc?99912

TYPICAL APPLICATIONS

- Inverters
- Choppers
- Induction heating
- All types of force-commutated converters

PRODUCT SUMMARY	
Package	TO-209AC (TO-94)
Diode variation	Single SCR
$I_{T(AV)}$	105 A
V_{DRM}/V_{RRM}	400 V, 800 V
V_{TM}	1.73 V
I_{TSM} at 50 Hz	3000 A
I_{TSM} at 60 Hz	3150 A
I_{GT}	200 mA
T_C/T_{hs}	85 °C

MAJOR RATINGS AND CHARACTERISTICS			
PARAMETER	TEST CONDITIONS	VALUES	UNITS
$I_{T(AV)}$		105	A
	T_C	85	°C
$I_{T(RMS)}$		165	A
I_{TSM}	50 Hz	3000	
	60 Hz	3150	
I^2t	50 Hz	45	kA ² s
	60 Hz	41	
V_{DRM}/V_{RRM}		400 to 800	V
t_q	Range	10 to 25	μs
T_J		-40 to 125	°C

ELECTRICAL SPECIFICATIONS

VOLTAGE RATINGS				
TYPE NUMBER	VOLTAGE CODE	V_{DRM}/V_{RRM} , MAXIMUM REPETITIVE PEAK VOLTAGE V	V_{RSM} , MAXIMUM NON-REPETITIVE PEAK VOLTAGE V	I_{DRM}/I_{RRM} MAXIMUM AT $T_J = T_J$ MAXIMUM mA
VS-ST103S	04	400	500	30
	08	800	900	



CURRENT CARRYING CAPABILITY							
FREQUENCY							UNITS
50 Hz	280	180	440	330	4730	3630	A
400 Hz	310	200	470	300	2500	1850	
1000 Hz	320	200	480	310	1530	1090	
2500 Hz	340	210	490	320	840	580	
Recovery voltage V_r	50		50		50		V
Voltage before turn-on V_d	V_{DRM}		V_{DRM}		V_{DRM}		
Rise of on-state current di/dt	50		-		-		A/ μ s
Case temperature	60	85	60	85	60	85	$^{\circ}$ C
Equivalent values for RC circuit	22/0.15		22/0.15		22/0.15		Ω/μ F

ON-STATE CONDUCTION					
PARAMETER	SYMBOL	TEST CONDITIONS		VALUES	UNITS
Maximum average on-state current at case temperature	$I_{T(AV)}$	180 $^{\circ}$ conduction, half sine wave		105	A
				85	$^{\circ}$ C
Maximum RMS on-state current	$I_{T(RMS)}$	DC at 76 $^{\circ}$ C case temperature		165	
Maximum peak, one half cycle, non-repetitive surge current	I_{TSM}	t = 10 ms	No voltage reappplied	3000	A
				t = 8.3 ms	
		t = 10 ms	100 % V_{RRM} reappplied	2530	
				t = 8.3 ms	
Maximum I^2t for fusing	I^2t	t = 10 ms	No voltage reappplied	45	kA^2s
				t = 8.3 ms	
		t = 10 ms	100 % V_{RRM} reappplied	32	
				t = 8.3 ms	
Maximum $I^2\sqrt{t}$ for fusing	$I^2\sqrt{t}$	t = 0.1 to 10 ms, no voltage reappplied		450	$kA^2\sqrt{s}$
Maximum peak on-state voltage	V_{TM}	$I_{TM} = 300$ A, $T_J = T_J$ maximum, $t_p = 10$ ms sine wave pulse		1.73	V
Low level value of threshold voltage	$V_{T(TO)1}$	$(16.7 \% \times \pi \times I_{T(AV)} < I < \pi \times I_{T(AV)})$, $T_J = T_J$ maximum		1.32	
High level value of threshold voltage	$V_{T(TO)2}$	$(I > \pi \times I_{T(AV)})$, $T_J = T_J$ maximum		1.35	
Low level value of forward slope resistance	r_{t1}	$(16.7 \% \times \pi \times I_{T(AV)} < I < \pi \times I_{T(AV)})$, $T_J = T_J$ maximum		1.40	$m\Omega$
High level value of forward slope resistance	r_{t2}	$(I > \pi \times I_{T(AV)})$, $T_J = T_J$ maximum		1.30	
Maximum holding current	I_H	$T_J = 25$ $^{\circ}$ C, $I_T > 30$ A		600	mA
Typical latching current	I_L	$T_J = 25$ $^{\circ}$ C, $V_A = 12$ V, $R_a = 6$ Ω , $I_G = 1$ A		1000	

SWITCHING					
PARAMETER	SYMBOL	TEST CONDITIONS		VALUES	UNITS
Maximum non-repetitive rate of rise of turned on current	di/dt	$T_J = T_J$ maximum, $V_{DRM} = \text{Rated } V_{DRM}$, $I_{TM} = 2 \times di/dt$		1000	A/ μ s
Typical delay time	t_d	$T_J = 25$ $^{\circ}$ C, $V_{DM} = \text{Rated } V_{DRM}$, $I_{TM} = 50$ A DC, $t_p = 1$ μ s Resistive load, gate pulse: 10 V, 5 Ω source		0.80	μ s
Maximum turn-off time	minimum	t_q	$T_J = T_J$ maximum, $I_{TM} = 100$ A, commutating $di/dt = 10$ A/ μ s $V_R = 50$ V, $t_p = 200$ μ s, dV/dt : See table in device code	10	
	maximum			25	



BLOCKING				
PARAMETER	SYMBOL	TEST CONDITIONS	VALUES	UNITS
Maximum critical rate of rise of off-state voltage	dV/dt	T _J = T _J maximum, linear to 80 % V _{DRM} , higher value available on request	500	V/μs
Maximum peak reverse and off-state leakage current	I _{RRM} , I _{DRM}	T _J = T _J maximum, rated V _{DRM} /V _{RRM} applied	30	mA

TRIGGERING				
PARAMETER	SYMBOL	TEST CONDITIONS	VALUES	UNITS
Maximum peak gate power	P _{GM}	T _J = T _J maximum, f = 50 Hz, d% = 50	40	W
Maximum average gate power	P _{G(AV)}		5	
Maximum peak positive gate current	I _{GM}	T _J = T _J maximum, t _p ≤ 5 ms	5	A
Maximum peak positive gate voltage	+V _{GM}		20	
Maximum peak negative gate voltage	-V _{GM}		5	V
Maximum DC gate current required to trigger	I _{GT}	T _J = 25 °C, V _A = 12 V, R _a = 6 Ω	200	mA
Maximum DC gate voltage required to trigger	V _{GT}		3	
Maximum DC gate current not to trigger	I _{GD}	T _J = T _J maximum, rated V _{DRM} applied	20	mA
Maximum DC gate voltage not to trigger	V _{GD}		0.25	

THERMAL AND MECHANICAL SPECIFICATIONS				
PARAMETER	SYMBOL	TEST CONDITIONS	VALUES	UNITS
Maximum junction operating temperature range	T _J		-40 to 125	°C
Maximum storage temperature range	T _{Stg}		-40 to 150	
Maximum thermal resistance, junction to case	R _{thJC}	DC operation	0.195	K/W
Maximum thermal resistance, case to heatsink	R _{thCS}	Mounting surface, smooth, flat and greased	0.08	
Mounting torque, ± 10 %		Non-lubricated threads	15.5 (137)	N · m (lbf · in)
		Lubricated threads	14 (120)	
Approximate weight			130	g
Case style		See dimensions - link at the end of datasheet	TO-209AC (TO-94)	

ΔR_{thJC} CONDUCTION				
CONDUCTION ANGLE	SINUSOIDAL CONDUCTION	RECTANGULAR CONDUCTION	TEST CONDITIONS	UNITS
180°	0.034	0.025	T _J = T _J maximum	K/W
120°	0.040	0.042		
90°	0.052	0.056		
60°	0.076	0.079		
30°	0.126	0.127		

Note

- The table above shows the increment of thermal resistance R_{thJC} when devices operate at different conduction angles than DC

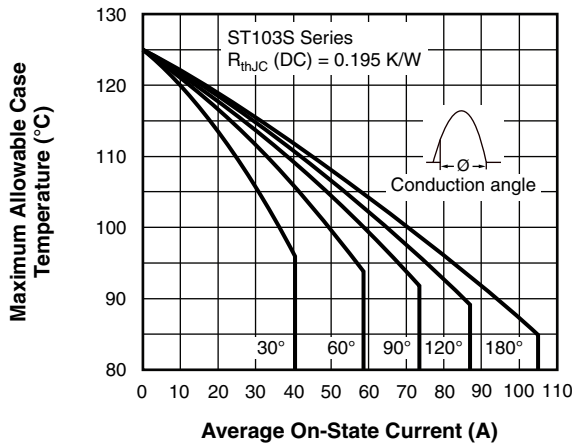

Fig. 1 - Current Ratings Characteristics

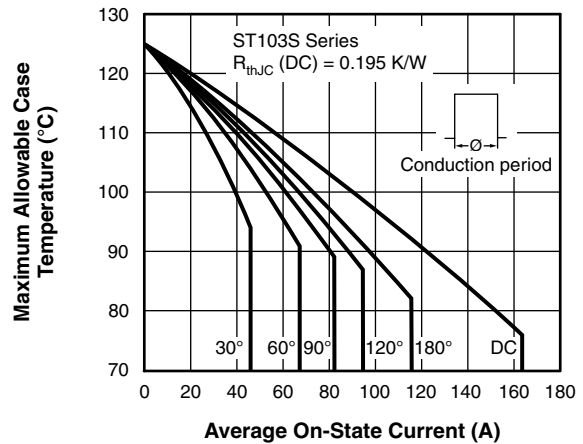

Fig. 2 - Current Ratings Characteristics

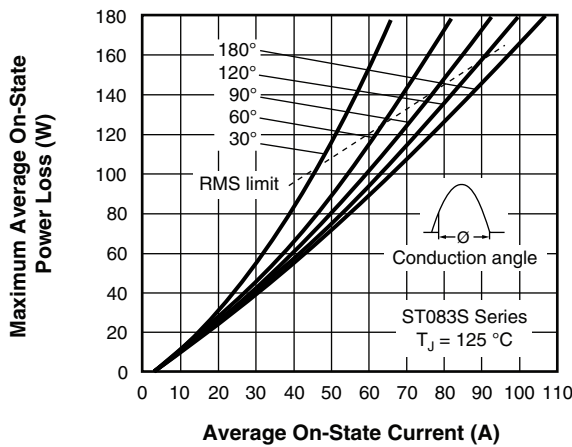

Fig. 3 - On-State Power Loss Characteristics

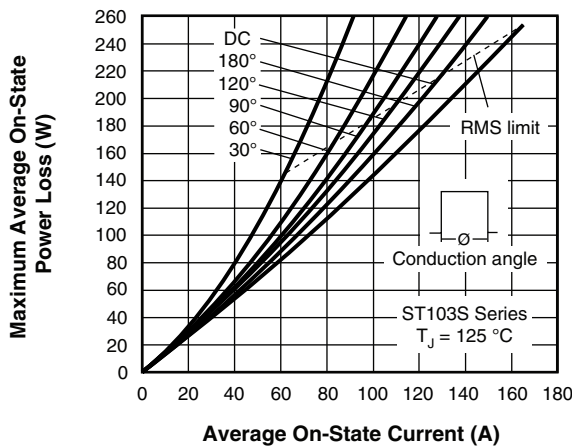
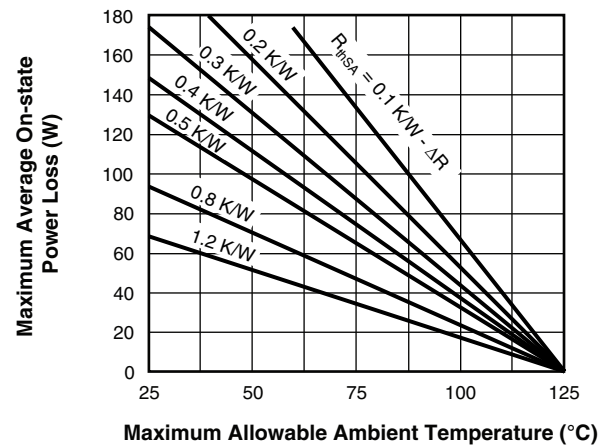
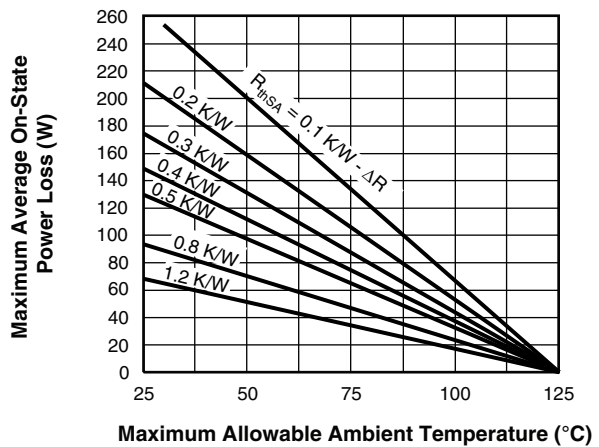

Fig. 4 - On-State Power Loss Characteristics



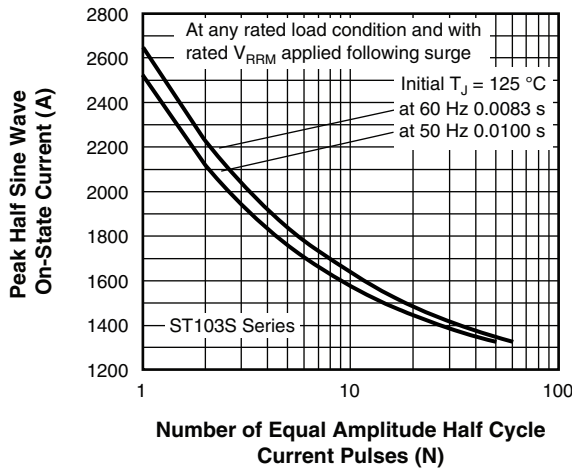

Fig. 5 - Maximum Non-Repetitive Surge Current

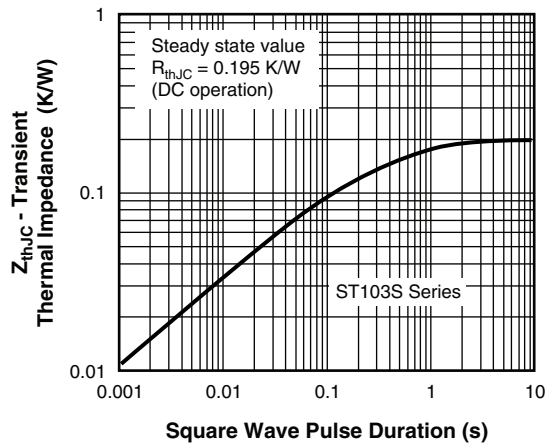

Fig. 8 - Thermal Impedance Z_{thJC} Characteristic

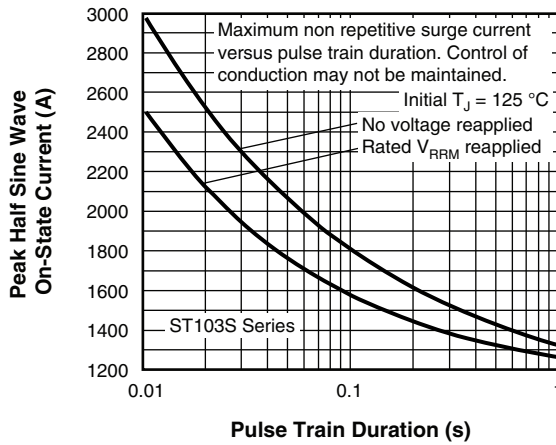

Fig. 6 - Maximum Non-Repetitive Surge Current

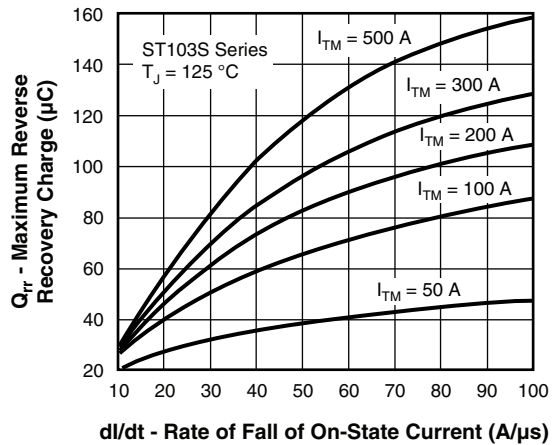

Fig. 9 - Reverse Recovered Charge Characteristics

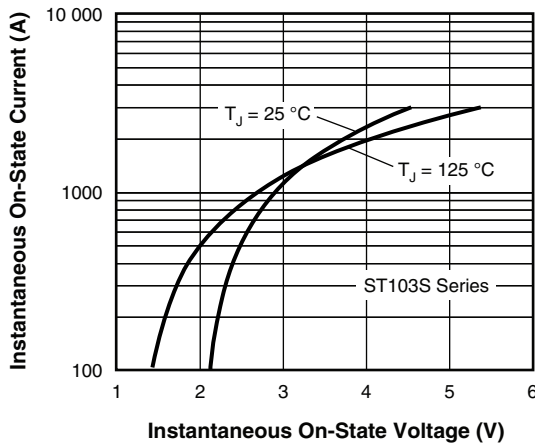

Fig. 7 - On-State Voltage Drop Characteristics

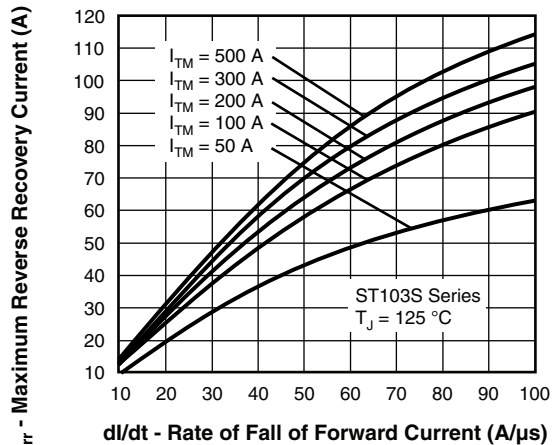

Fig. 10 - Reverse Recovery Current Characteristics

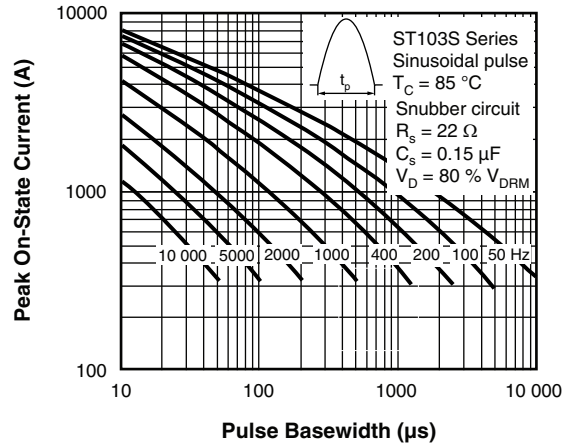
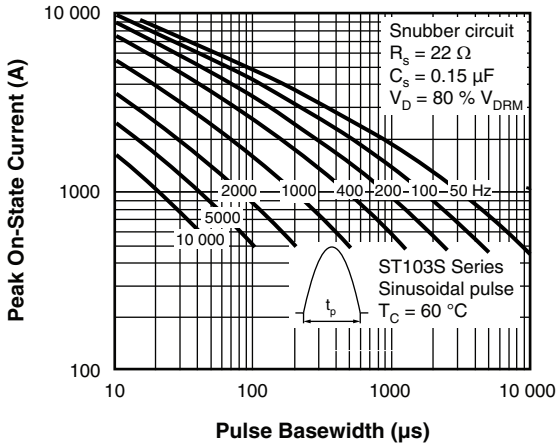

Fig. 11 - Frequency Characteristics

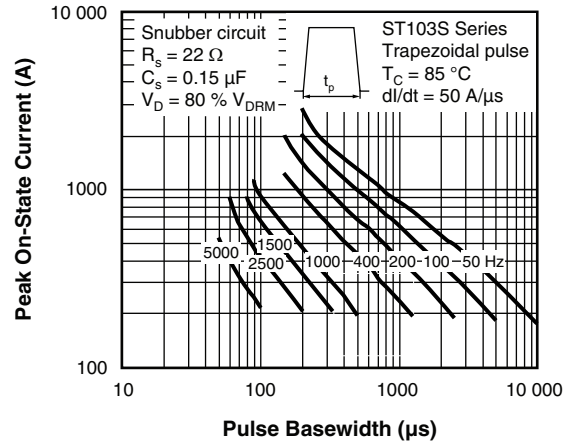
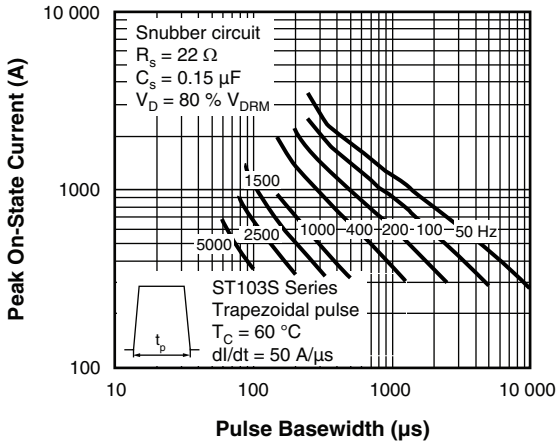

Fig. 12 - Frequency Characteristics

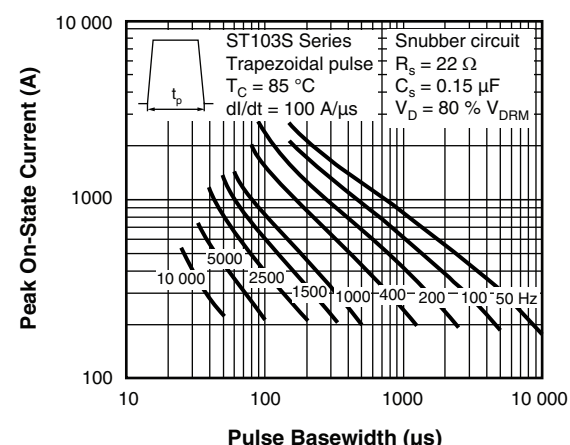
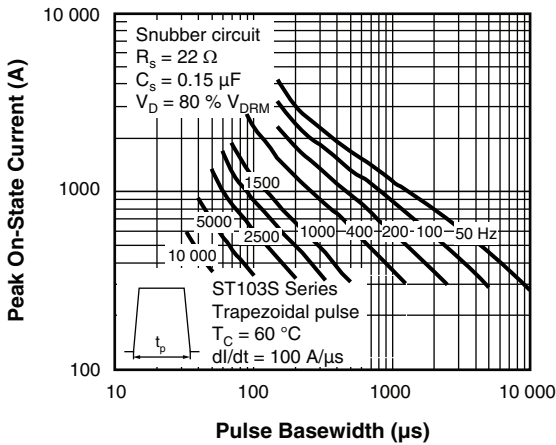

Fig. 13 - Frequency Characteristics

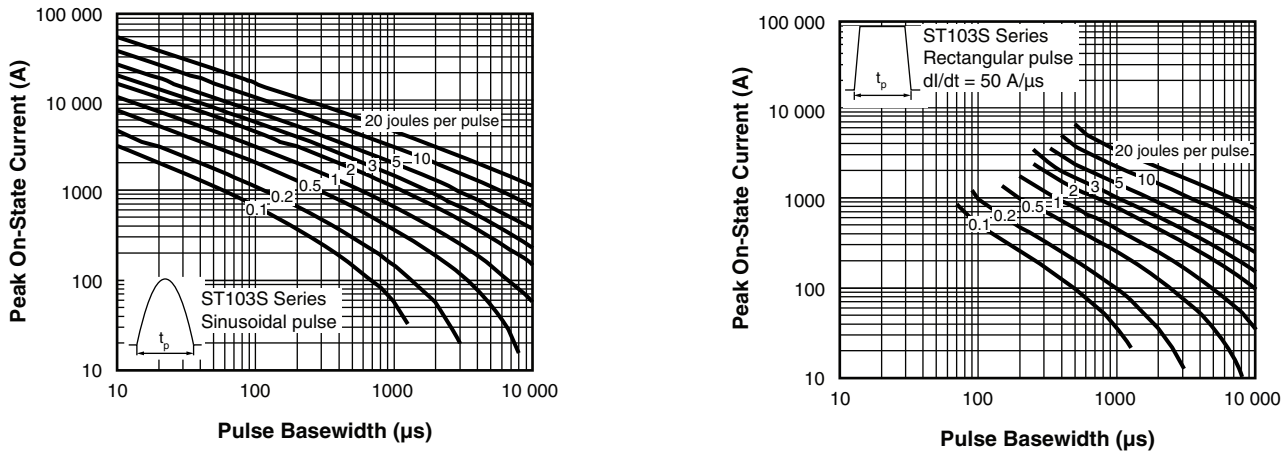

Fig. 14 - Maximum On-State Energy Power Loss Characteristics

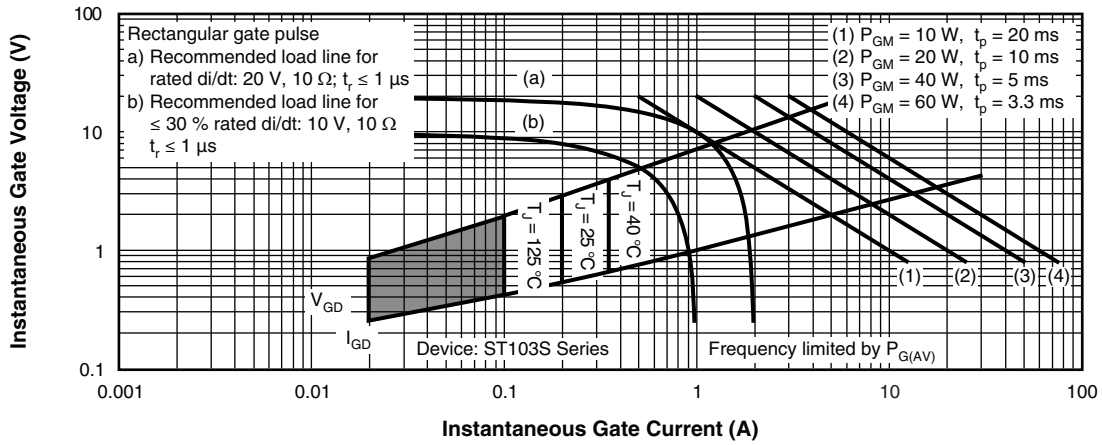
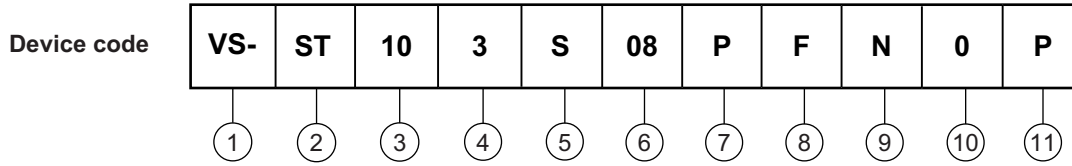

Fig. 15 - Gate Characteristics



ORDERING INFORMATION TABLE



- 1** - Vishay Semiconductors product
- 2** - Thyristor
- 3** - Essential part number
- 4** - 3 = Fast turn-off
- 5** - S = Compression bonding stud
- 6** - Voltage code x 100 = V_{RRM} (see Voltage ratings table)
- 7** - P = Stud base 1/2"-20UNF-2A
- 8** - Reapplied dV/dt code (for t_q test conditions)
- 9** - t_q code
- 10** - 0 = Eyelet terminals (gate and aux. cathode leads)
1 = Fast-on terminals (gate and aux. cathode leads)
- 11** - None = Standard production
P = Lead (Pb)-free

dV/dt - t_q combinations available					
dV/dt (V/μs)	20	50	100	200	400
10	CN	DN	EN	FN*	-
12	CM	DM	EM	FM	HM
15	CL	DL	EL	FL*	HL
18	CP	DP	EP	FP	HP
20	CK	DK	EK	FK	HK
25	-	-	-	-	HJ

* Standard part number.
All other types available only on request.

LINKS TO RELATED DOCUMENTS	
Dimensions	www.vishay.com/doc?95003

TO-209AC (TO-94) for ST083S and ST103S Series

DIMENSIONS in millimeters (inches)

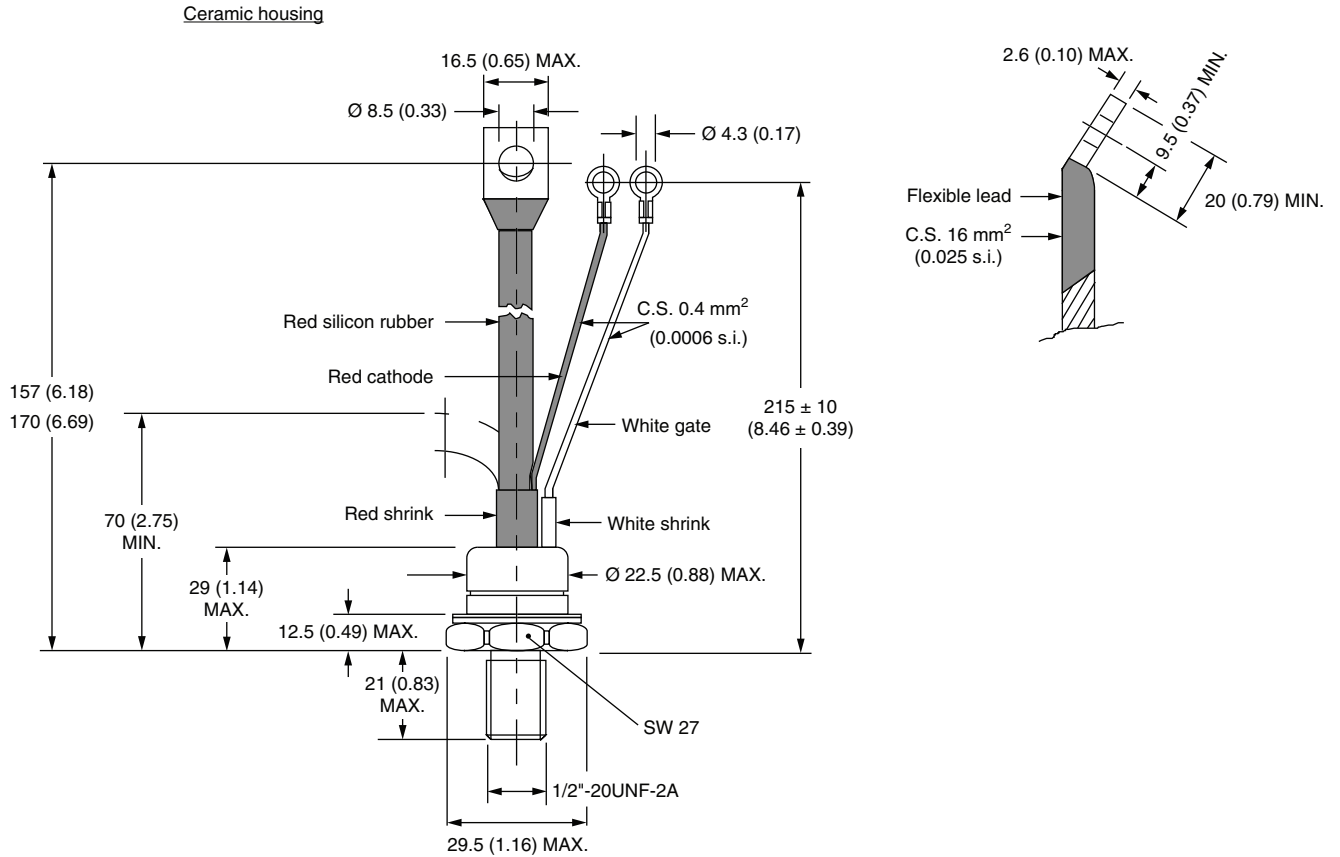



Disclaimer

ALL PRODUCT, PRODUCT SPECIFICATIONS AND DATA ARE SUBJECT TO CHANGE WITHOUT NOTICE TO IMPROVE RELIABILITY, FUNCTION OR DESIGN OR OTHERWISE.

Vishay Intertechnology, Inc., its affiliates, agents, and employees, and all persons acting on its or their behalf (collectively, "Vishay"), disclaim any and all liability for any errors, inaccuracies or incompleteness contained in any datasheet or in any other disclosure relating to any product.

Vishay makes no warranty, representation or guarantee regarding the suitability of the products for any particular purpose or the continuing production of any product. To the maximum extent permitted by applicable law, Vishay disclaims (i) any and all liability arising out of the application or use of any product, (ii) any and all liability, including without limitation special, consequential or incidental damages, and (iii) any and all implied warranties, including warranties of fitness for particular purpose, non-infringement and merchantability.

Statements regarding the suitability of products for certain types of applications are based on Vishay's knowledge of typical requirements that are often placed on Vishay products in generic applications. Such statements are not binding statements about the suitability of products for a particular application. It is the customer's responsibility to validate that a particular product with the properties described in the product specification is suitable for use in a particular application. Parameters provided in datasheets and/or specifications may vary in different applications and performance may vary over time. All operating parameters, including typical parameters, must be validated for each customer application by the customer's technical experts. Product specifications do not expand or otherwise modify Vishay's terms and conditions of purchase, including but not limited to the warranty expressed therein.

Except as expressly indicated in writing, Vishay products are not designed for use in medical, life-saving, or life-sustaining applications or for any other application in which the failure of the Vishay product could result in personal injury or death. Customers using or selling Vishay products not expressly indicated for use in such applications do so at their own risk. Please contact authorized Vishay personnel to obtain written terms and conditions regarding products designed for such applications.

No license, express or implied, by estoppel or otherwise, to any intellectual property rights is granted by this document or by any conduct of Vishay. Product names and markings noted herein may be trademarks of their respective owners.

Material Category Policy

Vishay Intertechnology, Inc. hereby certifies that all its products that are identified as RoHS-Compliant fulfill the definitions and restrictions defined under Directive 2011/65/EU of The European Parliament and of the Council of June 8, 2011 on the restriction of the use of certain hazardous substances in electrical and electronic equipment (EEE) - recast, unless otherwise specified as non-compliant.

Please note that some Vishay documentation may still make reference to RoHS Directive 2002/95/EC. We confirm that all the products identified as being compliant to Directive 2002/95/EC conform to Directive 2011/65/EU.

Vishay Intertechnology, Inc. hereby certifies that all its products that are identified as Halogen-Free follow Halogen-Free requirements as per JEDEC JS709A standards. Please note that some Vishay documentation may still make reference to the IEC 61249-2-21 definition. We confirm that all the products identified as being compliant to IEC 61249-2-21 conform to JEDEC JS709A standards.



Стандарт Электрон Связь

Мы молодая и активно развивающаяся компания в области поставок электронных компонентов. Мы поставляем электронные компоненты отечественного и импортного производства напрямую от производителей и с крупнейших складов мира.

Благодаря сотрудничеству с мировыми поставщиками мы осуществляем комплексные и плановые поставки широчайшего спектра электронных компонентов.

Собственная эффективная логистика и склад в обеспечивает надежную поставку продукции в точно указанные сроки по всей России.

Мы осуществляем техническую поддержку нашим клиентам и предпродажную проверку качества продукции. На все поставляемые продукты мы предоставляем гарантию .

Осуществляем поставки продукции под контролем ВП МО РФ на предприятия военно-промышленного комплекса России , а также работаем в рамках 275 ФЗ с открытием отдельных счетов в уполномоченном банке. Система менеджмента качества компании соответствует требованиям ГОСТ ISO 9001.

Минимальные сроки поставки, гибкие цены, неограниченный ассортимент и индивидуальный подход к клиентам являются основой для выстраивания долгосрочного и эффективного сотрудничества с предприятиями радиоэлектронной промышленности, предприятиями ВПК и научно-исследовательскими институтами России.

С нами вы становитесь еще успешнее!

Наши контакты:

Телефон: +7 812 627 14 35

Электронная почта: sales@st-electron.ru

Адрес: 198099, Санкт-Петербург,
Промышленная ул, дом № 19, литера Н,
помещение 100-Н Офис 331