

# Analog Devices Welcomes Hittite Microwave Corporation

NO CONTENT ON THE ATTACHED DOCUMENT HAS CHANGED



**THIS PAGE INTENTIONALLY LEFT BLANK**



## SMT GaAs MMIC x2 ACTIVE FREQUENCY MULTIPLIER, 27 - 31 GHz OUTPUT

### Typical Applications

The HMC577LC4B is suitable for:

- Clock Generation Applications:  
SONET OC-192 & SDH STM-64
- Point-to-Point & VSAT Radios
- Test Instrumentation
- Military & Space

### Features

- Very High Output Power: +20 dBm
- Low Input Power Drive: -2 to +6 dBm
- Very High Fo, 3Fo Isolation:  
>55 dBc @ Fout= 29 GHz
- 100 KHz SSB Phase Noise: -128 dBc/Hz
- Single Supply: +5V @ 213 mA
- 24 Lead 4x4mm QFN Package: 16mm<sup>2</sup>

### Functional Diagram

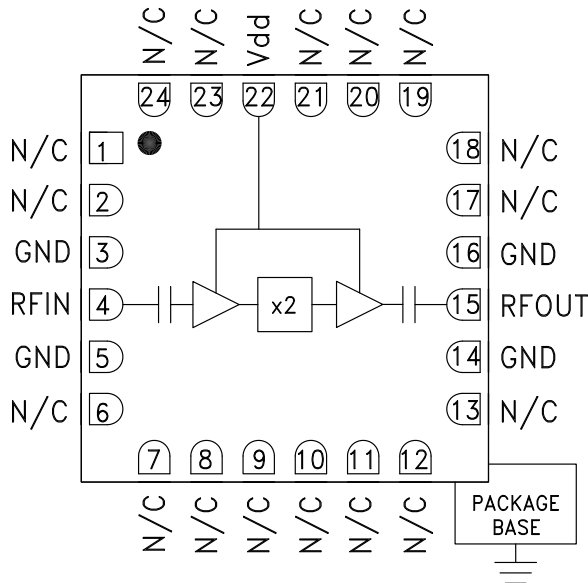

### General Description

The HMC577LC4B is a x2 active broadband frequency multiplier utilizing GaAs PHEMT technology in a leadless RoHS compliant SMT package. When driven by a +5 dBm signal, the multiplier provides +20 dBm typical output power from 27 to 31 GHz. The Fo and 3Fo isolations are >55 dBc at 29 GHz. The HMC577LC4B is ideal for use in LO multiplier chains for Pt-to-Pt & VSAT Radios yielding reduced parts count vs. traditional approaches. The low additive SSB Phase Noise of -128 dBc/Hz at 100 kHz offset helps maintain good system noise performance. The RoHS packaged HMC577LC4B eliminates the need for wire bonding, and allows the use of surface mount manufacturing techniques.

### Electrical Specifications, $T_A = +25^\circ C$ , $V_{dd} = +5V$ , 5 dBm Drive Level

Parameter	Min.	Typ.	Max.	Units
Frequency Range, Input	13.5 - 15.5			GHz
Frequency Range, Output	27 - 31			GHz
Output Power	15	20		dBm
Fo Isolation (with respect to output level)		60		dBc
3Fo Isolation (with respect to output level)		55		dBc
Input Return Loss		20		dB
Output Return Loss		7		dB
SSB Phase Noise (100 kHz Offset)		-128		dBc/Hz
Supply Current (I <sub>dd</sub> )		213		mA



## SMT GaAs MMIC x2 ACTIVE FREQUENCY MULTIPLIER, 27 - 31 GHz OUTPUT

**Output Power vs. Temperature @ 5 dBm Drive Level**

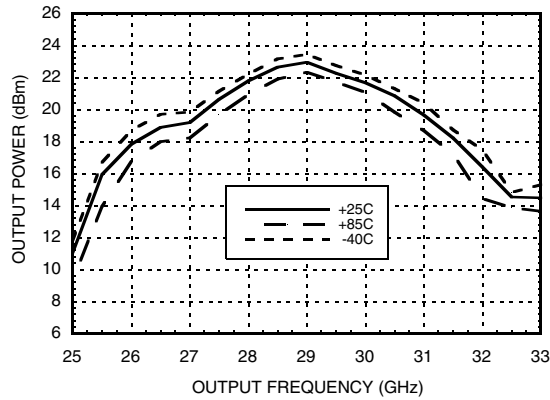

**Output Power vs. Drive Level**

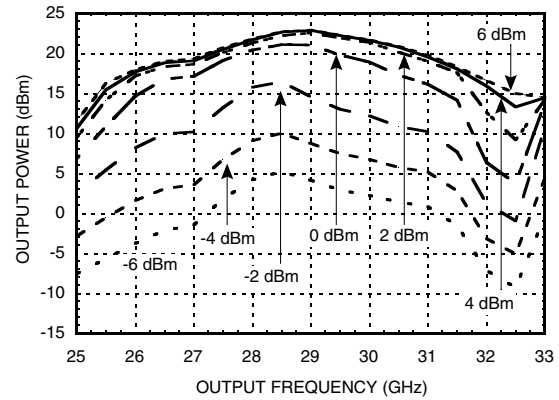

**Output Power vs. Supply Voltage @ 5 dBm Drive Level**

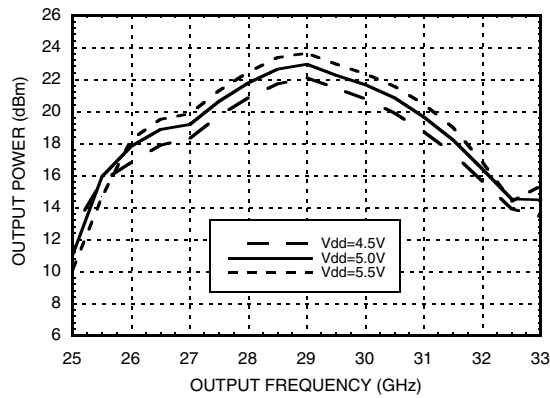

**Isolation @ 5 dBm Drive Level**

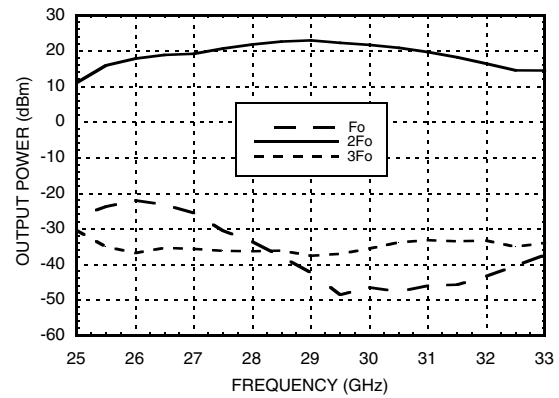

**Output Power vs. Input Power**

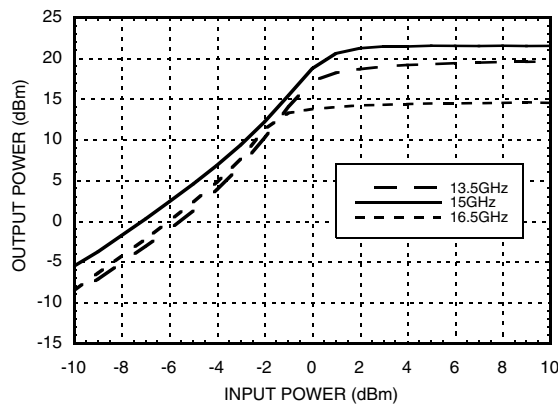

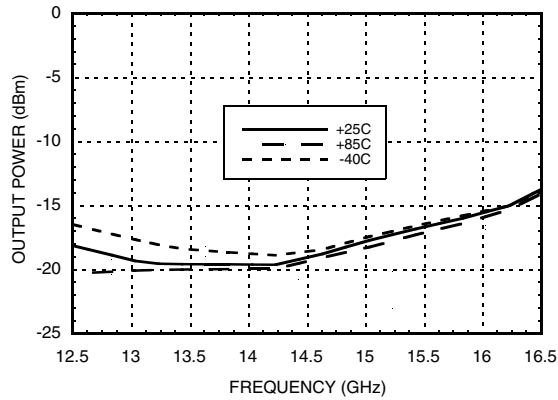
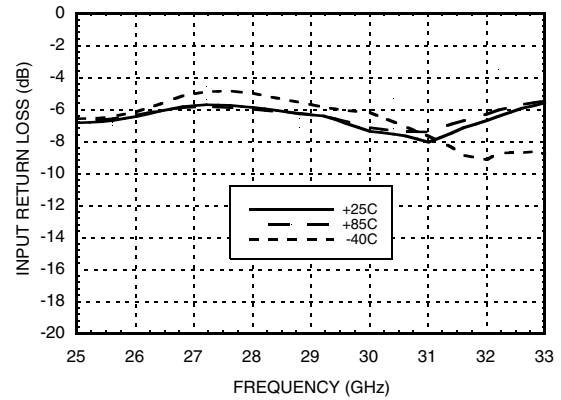
**SMT GaAs MMIC x2 ACTIVE FREQUENCY MULTIPLIER, 27 - 31 GHz OUTPUT****Input Return Loss vs. Temperature****Output Return Loss vs. Temperature**

## SMT GaAs MMIC x2 ACTIVE FREQUENCY MULTIPLIER, 27 - 31 GHz OUTPUT

### Absolute Maximum Ratings

RF Input (Vdd = +5V)	+13 dBm
Supply Voltage (Vdd)	+6.0 V
Channel Temperature	175 °C
Continuous Pdiss (T= 85 °C) (derate 13.8 mW/°C above 85 °C)	1.24 W
Thermal Resistance (channel to ground paddle)	73 °C/W
Storage Temperature	-65 to +150 °C
Operating Temperature	-40 to +85 °C

### Typical Supply Current vs. Vdd

Vdd (Vdc)	Idd (mA)
4.5	212
5.0	213
5.5	214

Note:  
Multiplier will operate over full voltage range shown above.



ELECTROSTATIC SENSITIVE DEVICE  
OBSERVE HANDLING PRECAUTIONS

### Outline Drawing

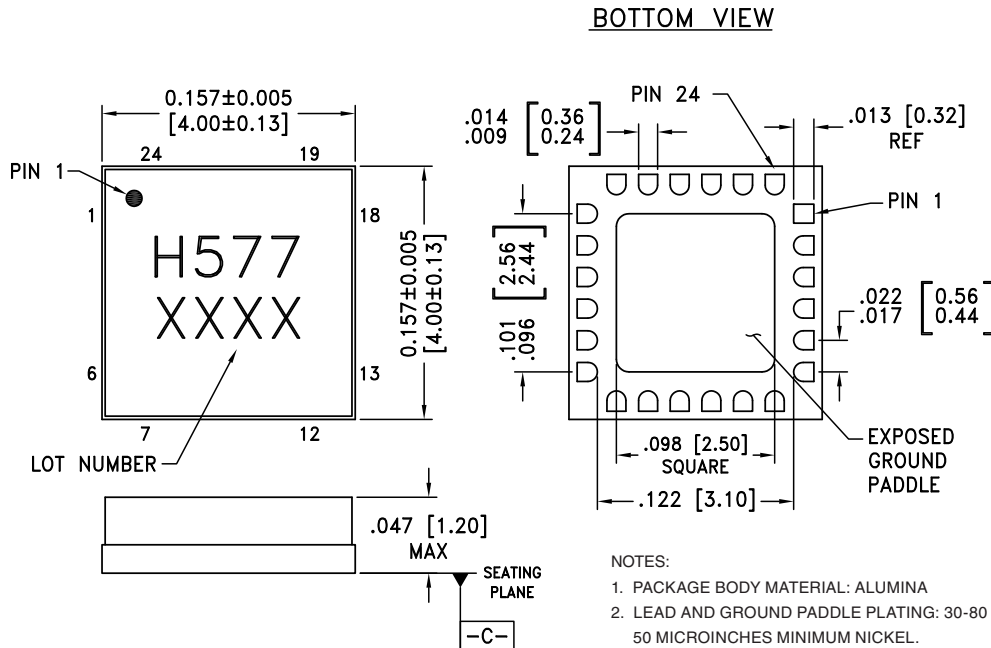

- NOTES:
1. PACKAGE BODY MATERIAL: ALUMINA
  2. LEAD AND GROUND PADDLE PLATING: 30-80 MICROINCHES GOLD OVER 50 MICROINCHES MINIMUM NICKEL.
  3. DIMENSIONS ARE IN INCHES [MILLIMETERS].
  4. LEAD SPACING TOLERANCE IS NON-CUMULATIVE
  5. PACKAGE WARP SHALL NOT EXCEED 0.05mm DATUM [-C-]
  6. ALL GROUND LEADS AND GROUND PADDLE MUST BE SOLDERED TO PCB RF GROUND.

### Package Information

Part Number	Package Body Material	Lead Finish	MSL Rating	Package Marking <sup>[2]</sup>
HMC577LC4B	Alumina, White	Gold over Nickel	MSL3 <sup>[1]</sup>	H577 XXXX

[1] Max peak reflow temperature of 260 °C

[2] 4-Digit lot number XXXX



## SMT GaAs MMIC x2 ACTIVE FREQUENCY MULTIPLIER, 27 - 31 GHz OUTPUT

### Pin Description

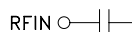
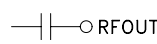
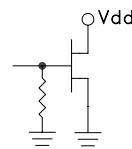
Pin Number	Function	Description	Interface Schematic
1, 2, 6 - 13, 17 - 21, 23, 24	N/C	These pins are internally not connected; however, this product was specified with these pins connected to RF/ DC ground.	
3, 5, 14, 16	GND	Package bottom must also be connected to RF/DC ground.	
4	RFIN	Pin is AC coupled and matched to 50 Ohms.	
15	RFOUT	Pin is AC coupled and matched to 50 Ohms.	
22	Vdd	Supply voltage 5V ± 0.5V. External bypass capacitors of 100 pF, 1,000 pF and 2.2 μF are required.	

### Application Circuit

Component	Value
C1	100 pF
C2	1,000 pF
C3	2.2 μF

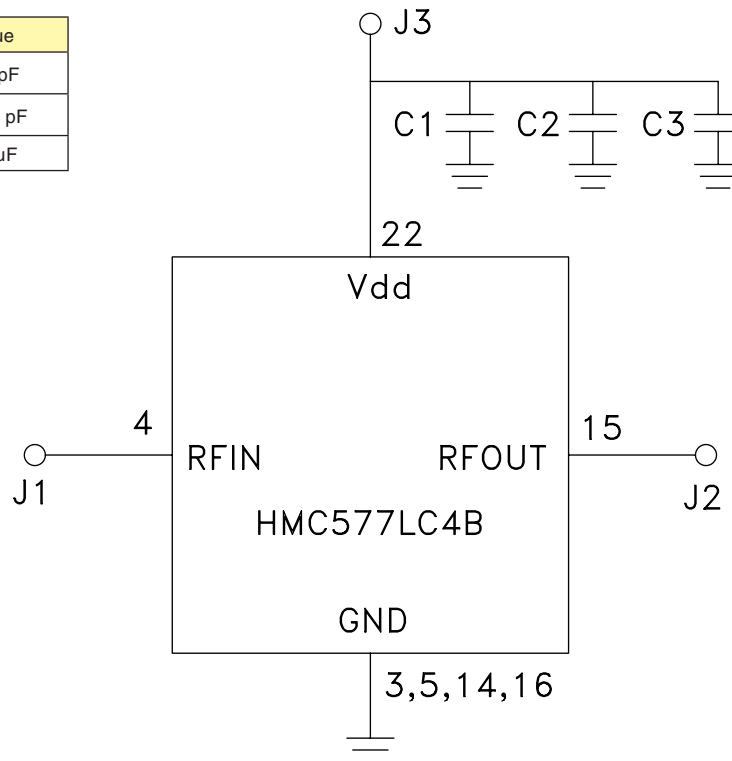



**SMT GaAs MMIC x2 ACTIVE FREQUENCY MULTIPLIER, 27 - 31 GHz OUTPUT**

**Evaluation PCB**

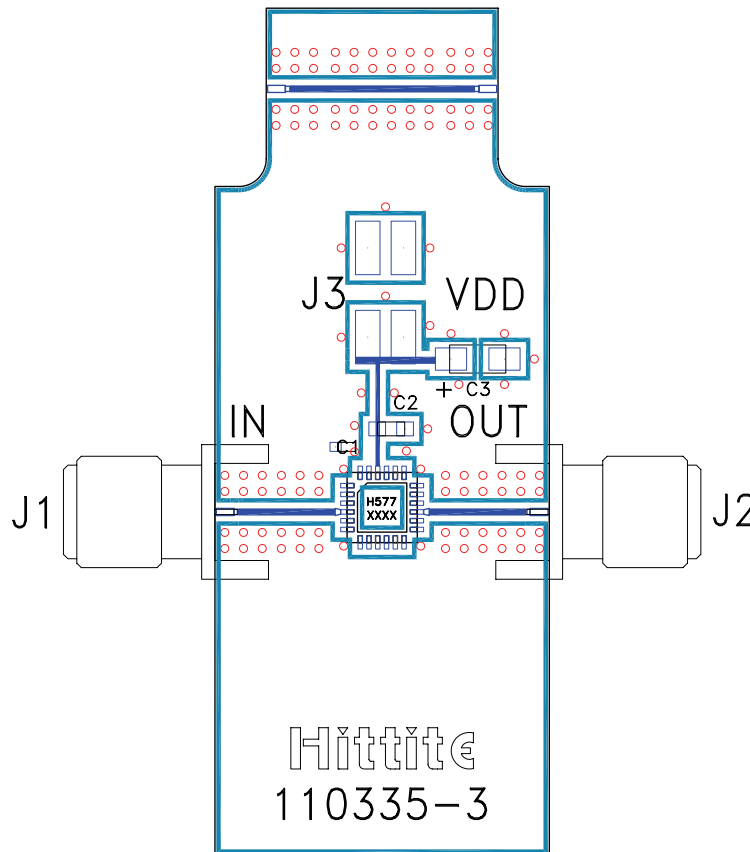

**List of Materials for Evaluation PCB 115223 [1]**

Item	Description
J1, J2	PCB Mount SRI K Connector
J3	Molex Header, 2mm
C1	100 pF Capacitor, 0402 Pkg.
C2	1,000 pF Capacitor, 0603 Pkg.
C3	2.2 μF Tantalum Capacitor
U1	HMC577LC4B x2 Active Multiplier
PCB [2]	110335 Eval Board

[1] Reference this number when ordering complete evaluation PCB

[2] Circuit Board Material: Rogers 4350

The circuit board used in the final application should be generated with proper RF circuit design techniques. Signal lines should have 50 ohm impedance while the package ground leads and exposed paddle should be connected directly to the ground plane similar to that shown. A sufficient number of via holes should be used to connect the top and bottom ground planes. The evaluation circuit board shown is available from Hittite upon request.





## Стандарт Электрон Связь

Мы молодая и активно развивающаяся компания в области поставок электронных компонентов. Мы поставляем электронные компоненты отечественного и импортного производства напрямую от производителей и с крупнейших складов мира.

Благодаря сотрудничеству с мировыми поставщиками мы осуществляем комплексные и плановые поставки широчайшего спектра электронных компонентов.

Собственная эффективная логистика и склад в обеспечивает надежную поставку продукции в точно указанные сроки по всей России.

Мы осуществляем техническую поддержку нашим клиентам и предпродажную проверку качества продукции. На все поставляемые продукты мы предоставляем гарантию .

Осуществляем поставки продукции под контролем ВП МО РФ на предприятия военно-промышленного комплекса России , а также работаем в рамках 275 ФЗ с открытием отдельных счетов в уполномоченном банке. Система менеджмента качества компании соответствует требованиям ГОСТ ISO 9001.

Минимальные сроки поставки, гибкие цены, неограниченный ассортимент и индивидуальный подход к клиентам являются основой для выстраивания долгосрочного и эффективного сотрудничества с предприятиями радиоэлектронной промышленности, предприятиями ВПК и научно-исследовательскими институтами России.

С нами вы становитесь еще успешнее!

### Наши контакты:

**Телефон:** +7 812 627 14 35

**Электронная почта:** [sales@st-electron.ru](mailto:sales@st-electron.ru)

**Адрес:** 198099, Санкт-Петербург,  
Промышленная ул, дом № 19, литера Н,  
помещение 100-Н Офис 331