

Typical Applications

Prescaler for DC to X Band PLL Applications:

- Point-to-Point / Multi-Point Radios
- VSAT Radios
- Test Equipment
- Fiber Optic
- Military & Space

Features

- Ultra Low SSB Phase Noise: -153 dBc/Hz
- Wide Bandwidth
- Output Power: 4 dBm
- Single DC Supply: +5V
- 8 Lead Hermetic SMT Package

Functional Diagram

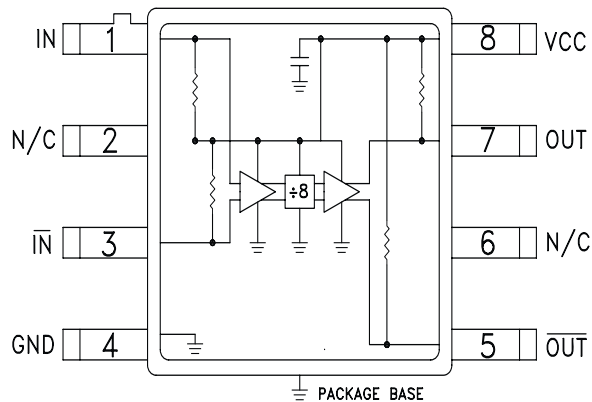

General Description

The HMC363G8 is a low noise Divide-by-8 Static Divider with InGaP GaAs HBT technology in an 8 lead glass/metal (hermetic) surface mount package. This device operates from DC (with a square wave input) to 12 GHz input frequency with a single +5.0V DC supply. The low additive SSB phase noise of -153 dBc/Hz at 100 kHz offset helps the user maintain good system noise performance.

Electrical Specifications, $T_A = +25^\circ \text{C}$, 50 Ohm System, $V_{CC} = 5V$

Parameter	Conditions	Min.	Typ.	Max.	Units
Maximum Input Frequency		12	13		GHz
Minimum Input Frequency	Sine Wave Input. [1]		0.2	0.5	GHz
Input Power Range	$F_{in} = 1$ to 6 GHz	-15	>-20	+10	dBm
	$F_{in} = 6$ to 8 GHz	-15	>-20	+5	dBm
	$F_{in} = 8$ to 12 GHz	-10	>-15	0	dBm
Output Power	$F_{in} = 12$ GHz	1	4.0		dBm
Reverse Leakage	Both RF Outputs Terminated		55		dB
SSB Phase Noise (100 kHz offset)	$P_{in} = 0$ dBm, $F_{in} = 6$ GHz		-153		dBc/Hz
Output Transition Time	$P_{in} = 0$ dBm, $F_{out} = 882$ MHz		100		ps
Supply Current (I_{CC})			90		mA

1. Divider will operate down to DC for square-wave input signal.

**SMT GaAs HBT MMIC
DIVIDE-BY-8, DC - 12 GHz**

Input Sensitivity Window, $T = 25\text{ }^{\circ}\text{C}$

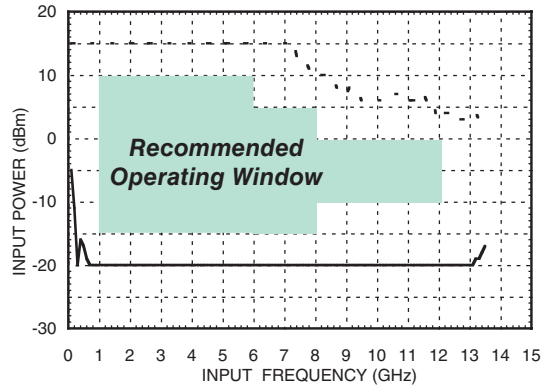

Input Sensitivity Window vs. Temperature

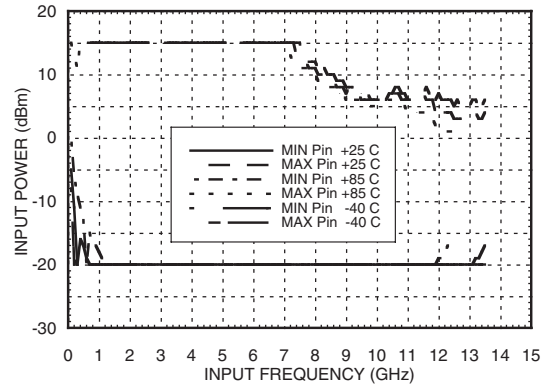

Output Power vs. Temperature

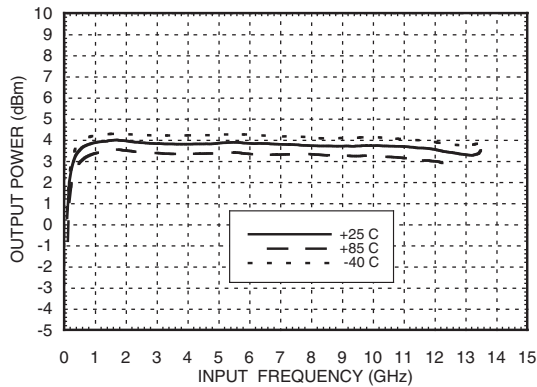

SSB Phase Noise

Performance, $P_{in} = 0\text{ dBm}$, $T = 25\text{ }^{\circ}\text{C}$

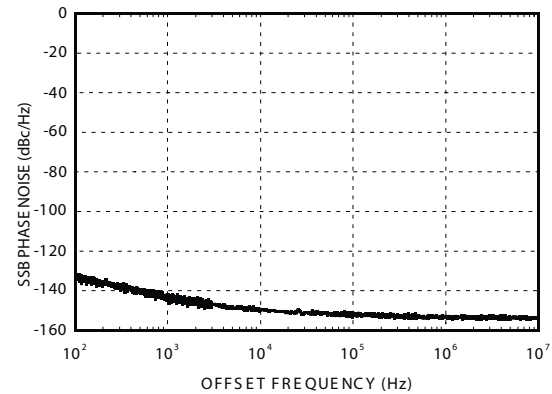

Output Harmonic

Content, $P_{in} = 0\text{ dBm}$, $T = 25\text{ }^{\circ}\text{C}$

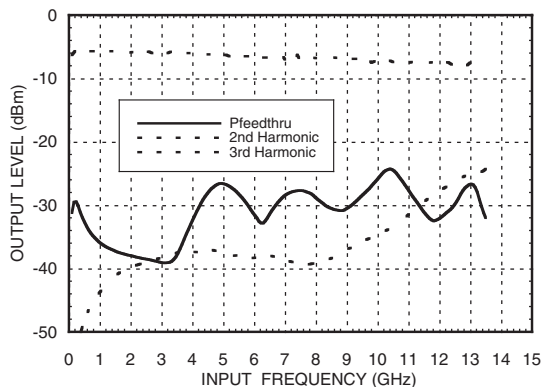

Reverse Leakage, $P_{in} = 0\text{ dBm}$, $T = 25\text{ }^{\circ}\text{C}$

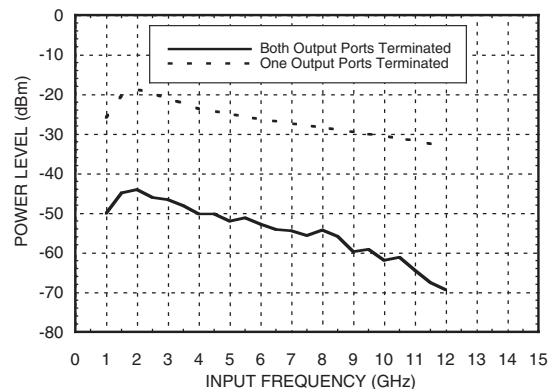

**Output Voltage Waveform,
Pin= 0 dBm, Fout= 882 MHz, T= 25 °C**

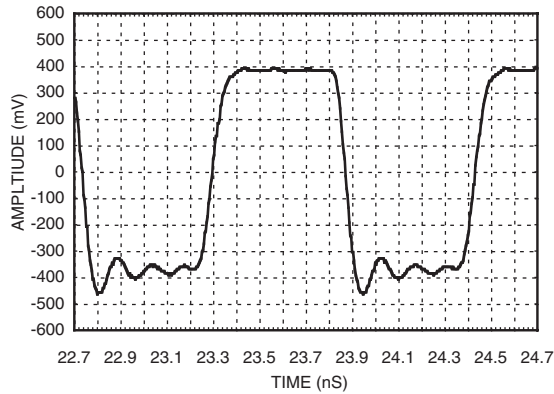

Absolute Maximum Ratings

RF Input (Vcc = +5V)	+13 dBm
Vcc	+5.5V
Channel Temperature (Tc)	135 °C
Continuous Pdiss (T= 85 °C) (derate 12.2 mW/ °C above 85 °C)	609 mW
Storage Temperature	-65 to +150 °C
Operating Temperature	-40 to +85 °C
Thermal Resistance (junction to ground paddle)	82 °C/W



**ELECTROSTATIC SENSITIVE DEVICE
OBSERVE HANDLING PRECAUTIONS**

Typical Supply Current vs. Vcc

Vcc (V)	Icc (mA)
4.75	85
5.0	90
5.25	100

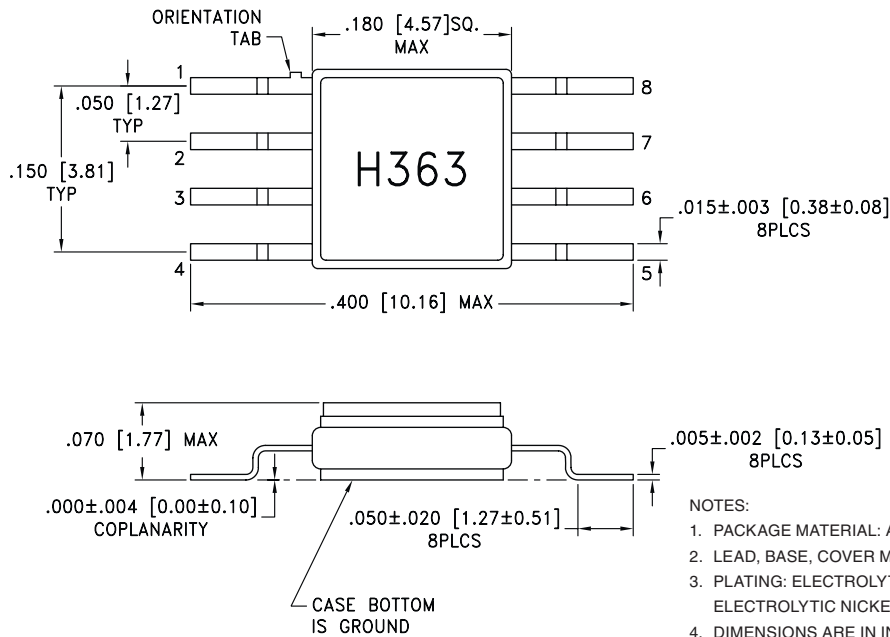

Note: Divider will operate over full voltage range shown above

Outline Drawing

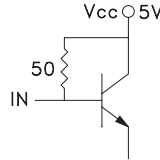
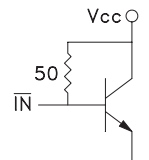

- NOTES:
1. PACKAGE MATERIAL: ALUMINA LOADED BOROSILICATE GLASS.
 2. LEAD, BASE, COVER MATERIAL: KOVAR™ (#7052 CORNING).
 3. PLATING: ELECTROLYTIC GOLD 50 MICROINCHES MIN., OVER ELECTROLYTIC NICKEL 50 MICROINCHES MIN.
 4. DIMENSIONS ARE IN INCHES [MILLIMETERS].
 5. TOLERANCES: ±.005 [0.13] UNLESS OTHERWISE SPECIFIED.
 6. ALL GROUND LEADS AND GROUND PADDLE MUST BE SOLDERED TO PCB RF GROUND.

Pin Description

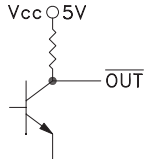
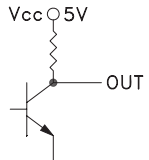
Pin Number	Function	Description	Interface Schematic
1	$\overline{\text{IN}}$	RF Input must be DC blocked.	
2, 6	N/C	No connection.	
3	IN	RF Input 180° out of phase with pin 1 for differential operation. AC ground for single ended operation.	
4	GND	Ground: Backside of package has exposed metal ground which must be connected to a RF/DC ground.	
5	$\overline{\text{OUT}}$	Divided output 180° out of phase with pin 7.	
7	OUT	Divided Output.	
8	VCC	Supply voltage 5V ± 0.25V.	

Evaluation PCB

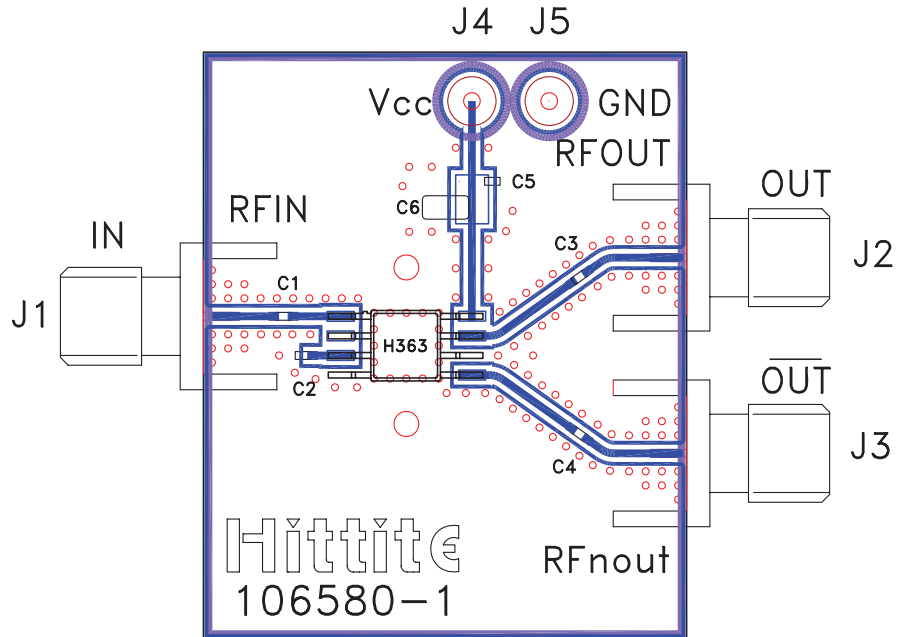

List of Materials for Evaluation PCB 106582 [1]

Item	Description
J1 - J3	PCB Mount SMA RF Connector
C1 - C4	100 pF Capacitor, 0402 Pkg.
C5	1000 pF Capacitor, 0603 Pkg.
C6	10 μ F Tantalum Capacitor
U1	HMC363G8 Divide-by-8
PCB [2]	106580 Eval Board

[1] Reference this number when ordering complete evaluation PCB

[2] Circuit Board Material: Rogers 4350

The circuit board used in the final application should use RF circuit design techniques. Signal lines should have 50 ohm impedance while the package ground leads and backside ground slug should be connected directly to the ground plane similar to that shown. A sufficient number of via holes should be used to connect the top and bottom ground planes. The evaluation circuit board shown is available from Hittite upon request. This evaluation board is designed for single ended input testing. J2 and J3 provide differential output signals.

Application Circuit

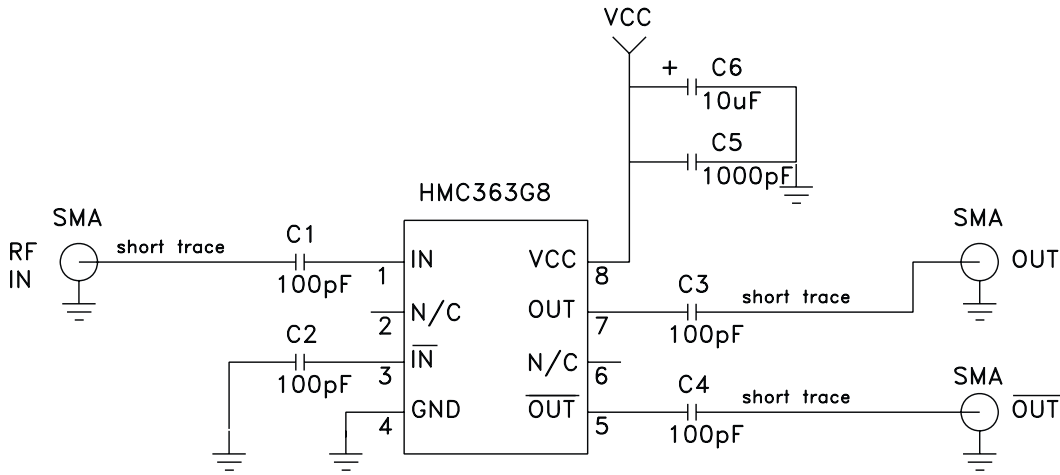



Стандарт Электрон Связь

Мы молодая и активно развивающаяся компания в области поставок электронных компонентов. Мы поставляем электронные компоненты отечественного и импортного производства напрямую от производителей и с крупнейших складов мира.

Благодаря сотрудничеству с мировыми поставщиками мы осуществляем комплексные и плановые поставки широчайшего спектра электронных компонентов.

Собственная эффективная логистика и склад в обеспечивает надежную поставку продукции в точно указанные сроки по всей России.

Мы осуществляем техническую поддержку нашим клиентам и предпродажную проверку качества продукции. На все поставляемые продукты мы предоставляем гарантию .

Осуществляем поставки продукции под контролем ВП МО РФ на предприятия военно-промышленного комплекса России , а также работаем в рамках 275 ФЗ с открытием отдельных счетов в уполномоченном банке. Система менеджмента качества компании соответствует требованиям ГОСТ ISO 9001.

Минимальные сроки поставки, гибкие цены, неограниченный ассортимент и индивидуальный подход к клиентам являются основой для выстраивания долгосрочного и эффективного сотрудничества с предприятиями радиоэлектронной промышленности, предприятиями ВПК и научно-исследовательскими институтами России.

С нами вы становитесь еще успешнее!

Наши контакты:

Телефон: +7 812 627 14 35

Электронная почта: sales@st-electron.ru

Адрес: 198099, Санкт-Петербург,
Промышленная ул, дом № 19, литера Н,
помещение 100-Н Офис 331