

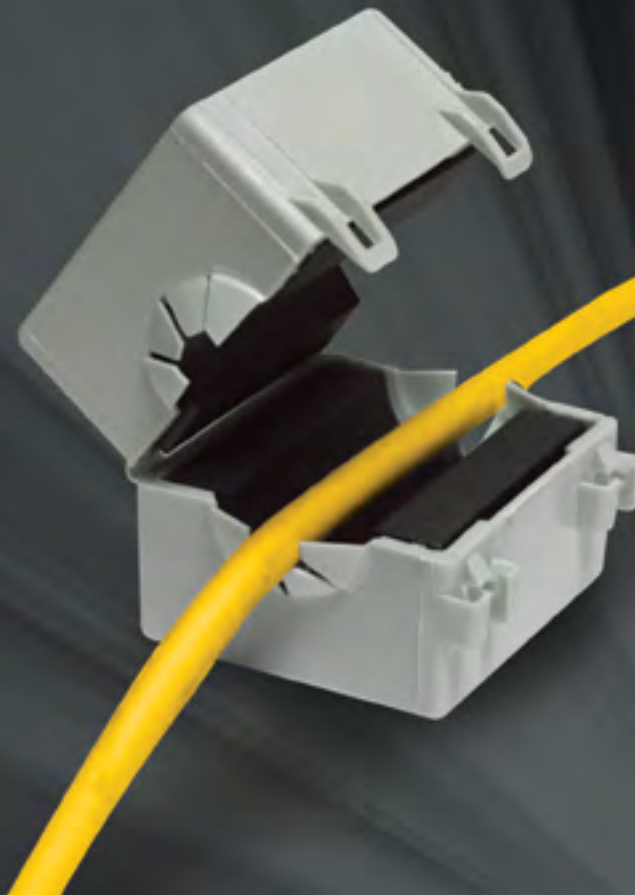

# FERRISHIELD **FERRITES**

**BISECTED & SOLID BEAD STYLES  
FOR ROUND AND FLAT CABLES & WIRES**

- World's Largest In-Stock Selection
- Frequency-Specific Formulations
- Flexible Mounting Options



**LEADER  
TECH**   
a HEICO company

*The Leading Edge in EMI Shielding Technology*

For more than 25 years, FerriShield ferrites have been the preferred cable shielding solution for many of the world's leading EMI Shielding Distributors, Sales Representatives and OEM's. Since acquiring the company in 2006, Leader Tech has embraced the FerriShield philosophy of maintaining the world's largest in-stock selection of bisected and solid core ferrites.



The addition of cable mounted ferrites to Leader Tech's existing EMI shielding product line has significantly increased value for our customers. Backed by unparalleled service and engineering support, Leader Tech now offers the market's most reliable selection of board, enclosure and cable shielding solutions.



## **FerriShield**<sup>®</sup> Ferrite Suppressors

Shielded enclosures, even the most robust designs, will permit electromagnetic energy to enter or exit along the main cabling. FerriShield Ferrites are one of the most versatile and cost-effective cable shielding methods available today. Our ferrites attack unwanted RF right on the circuit wiring, eliminating the need for more costly forms of RFI control. Available in solid and bisected designs, each style can make the task of regulatory compliance quicker and less troublesome.

Our bisected styles use FerriShield's innovative, quick-snap clamshell enclosures. This unique design concept offers engineers the ultimate in adaptability and easy installation. The RF absorbing core material interacts directly with unwanted high-frequency energy and dissipates it effectively while allowing data signals to pass unimpeded.



## ferrites for flat and round cables

**Universal Wideband Material (28 Material)**

- 10 cable snaps  
for round cables
- 12 sleeve snaps  
for round cables
- 13 USB cable sleeve snap  
with universal variable diameter
- 14 cable bundle clamps  
for wire and cable groups
- 14 telecom cable snaps  
for flat-oval cables
- 15 solid beads and toroids  
for round cables
- 15 extra large toroids  
up to 6.66" inside diameter
- 16 flat cable clamps  
for flat cables and flex circuits
- 16 low profile flat cable clamps  
for flat cables and flex-circuits
- 19 low profile solids  
for flat cables and flex-circuits
- 19 rectangular solids  
for flat cables and flex circuits
- 21 universal wideband bus bar ferrites  
extra large openings for most sizes

**Low-Frequency Material (33 Material)**

- 22 low frequency cable snaps  
for round cables
- 23 low frequency cable clamps  
for flat cables and flex circuits

**High-Frequency Material (25 Material)**

- 24 high frequency cable snaps  
for round cables
- 25 high frequency cable clamps  
for flat cables and flex circuits

**Bluetooth/Microwave Material (20 Material)**

- 26 bluetooth/microwave cable snaps  
for round cables
- 27 bluetooth/microwave cable clamps  
for flat cables

## RFID shielding

- 28 RFID overview  
13.56, 433.32, 860-930 MHz; 2.45 & 5.8 GHz
- 29 frequency-specific ferrites  
13.56, 433.32, 860-930 MHz; 2.45 & 5.8 GHz

## electrical and mechanical specifications

- 7 insertion loss formula  
simple engineering calculation model
- 9 technical information  
for specifying products
- 32 attenuation by part number  
impedance performance by frequency
- 33 material properties  
typical performance characteristics
- 33 cable size by part number  
recommended cable sizes

## testing aids

- 30 engineering kits and test equipment  
test fixtures, test probes
- 34 test probes  
electric and magnetic near-field detectors

## installation, ordering, part # reference

- 35 installation guidelines for ferrites  
cable size, positioning, attachment options
- 36 all part numbers by page number  
all catalog items in stock at all times
- 39 ordering  
general information, customer samples,  
ISO 9001:2008 Quality System Registration, RoHS



Simply one of the most flexible  
and cost-effective cable shielding  
solutions on the market



## PRODUCT OVERVIEW:

### 4 Frequency-Specific Ferrite Formulations

- 28 Material Wideband Ferrite (Most Popular)
- 33 Material Low-Frequency Ferrite
- 25 Material High-Frequency Ferrite
- 20 Material Bluetooth/Microwave Ferrite

### 1,000s of Styles and Sizes

- Solid and Bisected Styles
- I.D.'s from .034" to 6.6"
- Round, Square & Flat Shapes
- Special application designs

### 10 Flexible, Quick Mounting Options

#### Integrated Mounting Options:

- Snug Cable-Fit
- Button Mount
- Adhesive Mount
- Screw Mount
- Flexible-Grip End Ports

#### 2-Piece Mounting Options:

- Cable Tie Base
- Press Fit Base
- Adhesive Mount Base
- Screw Mount Base
- Screw Mount Strap

[www.leadertechinc.com](http://www.leadertechinc.com)

ISO 9001:2008 registered



**FerriShield**<sup>®</sup>  
Ferrite Suppressors

# HOW TO select a FerriShield Ferrite for your application

## 1 Choose a ferrite material

FerriShield ferrites are offered in (4) unique formulations. The chart below offers an overview of typical material properties and catalog page references.

| Ferrite                             | Performance               | Catalog Pages |
|-------------------------------------|---------------------------|---------------|
| 28 Material- Most Popular Wideband  | 10MHz-1GHz (250MHz peak)  | 10 to 21      |
| 33 Material- Low-Frequency Ferrite  | 1MHz-60MHz (30MHz peak)   | 22 to 23      |
| 25 Material- High-Frequency Ferrite | 1MHz-1.2GHz (700MHz peak) | 24 to 25      |
| 20 Material- Bluetooth/Microwave    | 2.45GHz peak              | 26 to 27      |

*For detailed Attenuation and Material Properties see page 32 and 33*



## 2 Select a mounting option

Each section of this catalog features multiple mounting options for bisected and solid bead ferrites. FerriShield Ferrites are recognized for their ease of installation and reliable performance over time.



## 3 Select the inside diameter of your ferrite

FerriShield Ferrites are designed to fit tight against the cable or wiring bundle that requires shielding. Ideally, you should select a ferrite with an inside diameter that is slightly less (+/- .04") than the outside diameter of your cable.

For quick reference, all part numbers in this catalog have an accompanying technical drawing and specifications chart that illustrates dimensions and impedance for the selected ferrite.

For a more detailed technical explanation see page 33.



## Helpful Tips and Insider Hints

- Ferrite performance typically increases as ferrite volume increases. The larger the ferrite mass, the better the RF attenuation.
- Smaller cables can be looped through larger ferrites to increase performance. Impedance increase by the square of the number of loops. For example, by looping a cable through a ferrite 2 times ( $2^2$ ), impedance increases by a factor of 4.

*For a detailed explanation see page 6- Electromagnetic Characteristics*

- Ferrite installation guidelines and recommendations are shown on page 35
- Attenuation properties by part number can be referenced on page 32
- Maximum recommend cable size by part number can be found on page 33





## Product Profile

Ferrite shielding materials are widely accepted as providing the simplest, most convenient and most cost-effective solution for radio frequency interference problems in cables and connectors. Further, they accomplish both RF attenuation and suppression of unwanted high frequency oscillations with no loss in dc or low frequency signal strength.

The basic composition of ferrite materials is a combination of ferrous oxide and one or more other powdered metals - most often manganese, zinc, cobalt or nickel. An extensive selection of shapes and sizes is already available, and custom geometries may be manufactured for special situations.

There are infinite varieties of formulas and performance levels possible. Each discrete ferrite formulation results in a stoichiometric ratio which is its performance characteristic signature regarding electrical, magnetic and mechanical relationships. The most common expression of ferrites' performance capabilities is in terms of their permeability ( $\mu$ ). This property expresses the ratio of the magnitude of magnetic induction to magnetizing force. The materials are normally categorized according to initial permeability ( $\mu_i$ ).

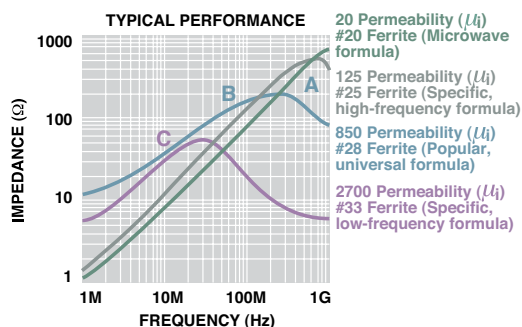

fig. 1 Typical attenuation profiles

FerriShield has developed four principal formulations which together serve the common spectrum of today's RFI needs. For frequencies from 10 MHz to 1 GHz, #28 formulation is recommended, especially when higher frequency harmonics are a consideration. For frequencies typified by microprocessor speeds in excess of 100MHz and harmonics peak interference at nominally 700MHz, #25 formulation is designed to cover this range with even some effect beyond that. For frequencies from 1 MHz to 30 MHz, #33 material offers a concentration of impedance in that range with a decreasing effect above 30 MHz. For microwave frequencies relating to Bluetooth™ 2.45GHz operations, the #20 material is available. See figure 1 above.

## Electromagnetic Characteristics

Stated most simply, the operative characteristic which makes ferrites effective in RFI/EMI suppression is their variable sensitivity to frequency. With a ferrite installed as a suppressor, lower frequencies will pass with no significant loss. But above the frequency where  $(\tan \delta/\mu)$  climbs sharply (see figure 1), the signal couples with the ferrite to create an impedance which is quite high compared with the rest of the circuit. The offending RFI is thus immediately and consistently blocked out by way of impedance damping of the unwanted high frequency signals. It is this greater resistive impedance which allows the basically passive, apparently simple material to suppress multiple signals in a variety of application situations.

fig. 2 Impedance comparison vs. cubic volume.

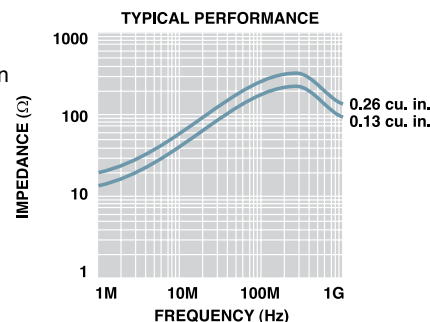
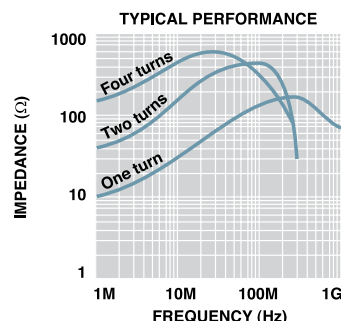

fig. 3 Two turn loop through ferrite increases effective magnetic path. Impedance increases by the square of the number of turns ( $N^2$ ).



fig. 4 Increased impedance; multiple turns ( $N^2$ ) vs. one turn through ferrite; i.e., 2 turns ( $2^2$ ) = 4 times impedance





## Organizing the Engineering Model

To understand the various practical modeling techniques employed with ferrite, it is best to prepare a properly engineered calculation of expected results. An empirical trial and error method may leave the circuit close to borderline performance without adequate safety margins. As indicated previously, a wide range of formulations is possible. The major application factors to be used when defining a specific ferrite solution for a particular interference problem include the following:

- Frequency where maximum attenuation is required.
- Amount of attenuation needed.
- Ferrite permeability formulation characteristics as they relate to the frequency range in question (i.e., initial permeability)
- Ferrite formulation consistency (i.e., expected range of variation in attenuation performance)
- Installation environment and mechanical attachment requirements.

The frequency range requiring attenuation must be matched to the performance of a given ferrite composition (figure 1 on previous page). The optimum profile would be a ferrite in which the highest attenuation level coincides with the disruptive frequency (A). That same ferrite could be used even if the frequency falls in a lower area of its impedance curve (B) but there would be correspondingly reduced attenuation. Conversely, a different ferrite formulation could be employed in the same frequency situation with the intent of using a lower part of its performance curve (C). Space and weight considerations are not normally a concern since good quality ferrites provide high performance per a given cubic volume.

The modeling procedure to calculate impedance characteristics of the source and load coupled with the ferrite suppressor is developed as follows:

$$\text{Insertion Loss (dB)} = 20 \log_{10} \frac{(Z_A + Z_B + Z_F)}{(Z_A + Z_B)}$$

Where:

Insertion Loss = A measure of the effectiveness of a filter, expressed in decibels, is described as the ratio of voltages with, and without, the filter in the circuit.

- $Z_A$  = Source Impedance
- $Z_B$  = Load Impedance
- $Z_F$  = Ferrite Impedance

If the circuit impedance ( $Z_A + Z_B$ ) is 50 ohms and the ferrite impedance is 250 ohms, then the insertion loss will be:  
 $20 \text{ Log}_{10} (50+250)/50 = 15.56 \text{ dB}$

Even though the same unit of ferrite is used, the attenuation provided by a ferrite suppressor can differ somewhat as the original circuit impedance varies. The ferrite is more effective when the circuit impedance is low. For example, by using the same 250 ohm ferrite in a 75 ohm circuit, the result will be:

$$20 \text{ Log}_{10} (75 + 250)/75 = 12.7 \text{ dB}$$

With a high circuit impedance, it may be possible to increase the number of turns or passes through the ferrite (figures 3 and 4), or to use a larger amount of ferrite (cubic volume) in the circuit in order to achieve the same level of insertion loss (fig. 2). By increasing the number of turns (passes) through the ferrite opening, the "effective magnetic path" is increased – impedance then increases by the square of the number of turns ( $N^2$ ); i.e., two turns ( $2^2$ ) = 4 times the impedance. When additional ferrite volume is added, impedance increases on almost a direct percentage basis; i.e., a 100 percent increase in volume will provide about 100 percent increase in impedance (figure 2) in most situations according to certain prescribed dimensional ratios.

An alternative modeling procedure may also be structured in reverse by solving for a desired insertion loss goal. The result yields an impedance requirement. This can be matched to known performance profiles of existing ferrite configurations in the geometric style best suited for mechanical and packaging requirements.

As an example, a 15dB insertion loss is required for a flat ribbon cable at 100 MHz. Using the formula:

$$\text{Insertion Loss (dB)} = 20 \log_{10} \frac{(Z_A + Z_B + Z_F)}{(Z_A + Z_B)}$$

Where: IL = 15 dB

$Z_A$  = 25 ohms

$Z_B$  = 25 ohms

$Z_F$  = Unknown ferrite impedance  
(solve for this value)

$$15\text{dB} = 20 \text{ Log}_{10} \left( \frac{50 + Z_F}{25 + 25} \right)$$

$$0.75 = \text{Log}_{10} \left( \frac{50 + Z_F}{50} \right)$$

$$5.625 = \frac{50 + Z_F}{50}$$

$$Z_F = 231.25 \text{ ohms}$$

Next, refer to the Attenuation Properties on page 36. The flat ribbon cable style part that closely matches is #28B2480 with a 250½ impedance at 100 MHz.

Once the ferrite suppressor is installed in the circuit, results should be confirmed by testing. Although these ferrites are "linear," the term is relative to the common operating range of temperatures. The permeability is different at every degree of temperature. The published initial permeability ( $\mu_i$ ) nomenclature applies to standard temperature, 59°F (15°C) only. There are only minor impedance differences, however, throughout normal operational ranges and up to 180° F (82°C). See Material Properties on page 33.

## Controlling RFI/EMI

Any device used to block an RFI signal between its source and a receiver is an electromagnetic interference (EMI) shield.

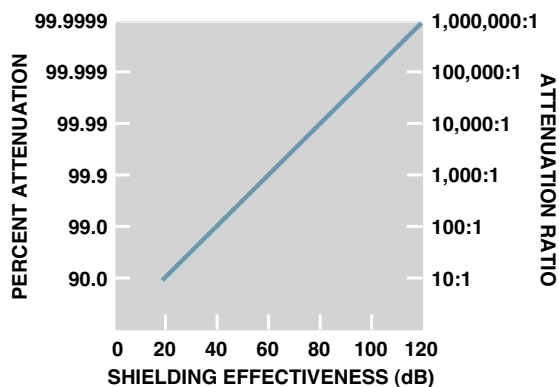

The measure of this ability to attenuate RFI is Shielding Effectiveness, SE, which is expressed in decibels, dB, the ratio of field strength on one side of the shield to the other side. The figure above shows the relationship between shielding effectiveness (in dB), the amount of attenuation, and attenuation percentage.

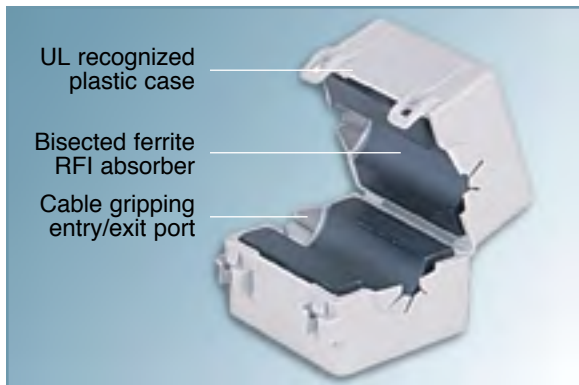

Typical FerriShield RFI suppressor.

## FerriShield Advantages



I/O cable with RFI suppressor.

The concept of bisected ferrites has been developed to address a number of industry needs in the area of Electromagnetic Compatibility, EMC.

- engineering adaptability
- risk-free engineering:
  - tight tolerance performance
  - easy to upgrade attenuation by changing size or number of turns.
- easy retrofitting
- convenient installation
- integral mounting features
- cost-effectiveness
- extended resistance to core saturation under Direct Current loads.
- consistent performance

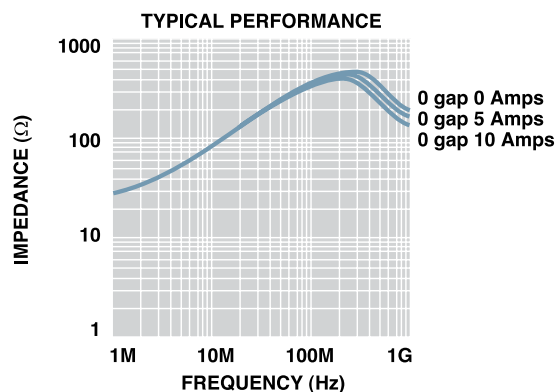

Gap effect of ferrite subjected to direct current.

## Design Support

Engineering assistance is always available. We will be pleased to help with applications, cross-referencing or complete insertion loss calculations when a custom suppressor is required.

The technical air gap in bisected ferrites actually extends current carrying capability with only an imperceptible reduction in impedance versus solid ferrites of the same size. The gap is magnetically insignificant while it is electrically significant as a discontinuation, thereby accommodating more current.



## Installation is simple

Just snap over circuit wiring to be controlled - even after wiring has been terminated Radio interference sources usually radiate their RFI power at frequencies above 30 MHz by way of the main cabling, which acts as an antenna.

## Anywhere There is an Antenna-Like Structure

Electronic cabling and wires, by virtue of their length-to-width ratios, are perfect natural antennas. In the presence of high speed microprocessor signals, cables will conduct, radiate and/or receive unwanted high frequency interfering signals. Control of radio frequency interference can be assured by proper placement of an insertion loss device, such as a ferrite suppressor.

### CABLING

RFI suppressor functions

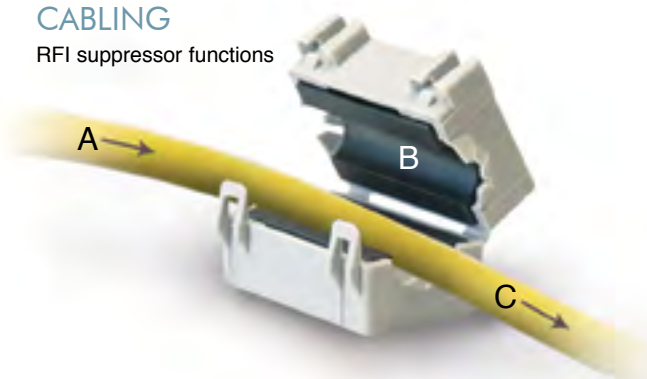

- A. Data signals and high frequency interference signals absorbed and conducted
- B. All high frequency interference absorbed by ferrite suppressor and thermally dissipated
- C. Low frequency data signals pass unimpeded

### BUS BARS

RFI suppressor functions: bus bars

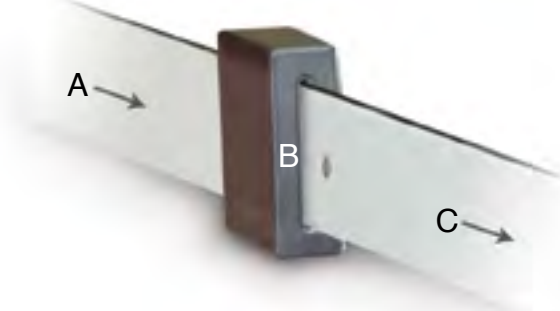

- A. Power distribution and high frequency interference signals absorbed and conducted
- B. All high frequency interference absorbed by ferrite suppressor and thermally dissipated
- C. Power distribution characteristics pass unimpeded

## Application Points

FerriShield installation locations.



## Advantages

Compared to other alternatives, ferrites' high resistivity per cubic volume stands out as the most important advantage. Prior to the development of bisected ferrites, suppression engineering was restricted to the costly addition of filters, cable shielding, and less versatile solid core (not bisected) ferrites. While these methods offer a degree of suppression, they are often awkward to install and, in many cases, are not completely effective. Bisected ferrites have a concentrated, homogeneous magnetic structure with high permeability. They are consistently stable versus time and temperature, and provide RF suppression without high eddy current losses.



**cable snap**

Ferrite assembly in fully enclosed nylon case; functional with wires and cables up to a 2.0" (50,8mm) diameter. Snap closed around wire by clasping shut to position assembly.

May also be mounted with a flat-head screw through the .120" (3,0mm) diameter hole in the bottom by temporarily removing lower ferrite half.

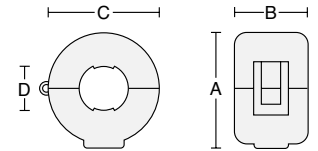

| PART No.  | A           | B          | C           | D          | IMPEDANCE IN OHMS |
|-----------|-------------|------------|-------------|------------|-------------------|
| CS28B1642 | .852 21,6   | .885 22,5  | .840 21,3   | .282 7,2   | 100 @ 100MHz      |
| CS28B1805 | 1.040 26,4  | .667 16,9  | 1.025 26,4  | .340 8,6   | 73 @ 100MHz       |
| CS28B1937 | 1.182 30,0  | .780 19,8  | 1.188 30,2  | .425 10,8  | 117 @ 100MHz      |
| CS28B1984 | 1.218 30,9  | .705 17,9  | 1.220 31,0  | .525 13,3  | 62 @ 100MHz       |
| CS28B1501 | 1.725 43,8  | 1.232 31,3 | 1.720 43,7  | .710 18,0  | 177 @ 100MHz      |
| CS28B1500 | 1.725 43,8  | 1.232 31,3 | 1.720 43,7  | .960 24,4  | 133 @ 100MHz      |
| CS28B2000 | 2.350 59,7  | 1.851 47,0 | 2.309 58,6  | .960 24,4  | 380 @ 100MHz      |
| CS28B4000 | 4.500 114,2 | 1.851 47,0 | 4.687 119,0 | 1.960 49,8 | 290 @ 100MHz      |

See page 31 for more details



**cable snap**

**WITH PRESS-FIT BUTTON MOUNT BASE.** Ferrite assembly in fully enclosed nylon case; functional with wires and cables up to a 1.0" (25,4mm) diameter. Includes a button mount base which press-fits into a .150" (3,8mm) diameter hole.

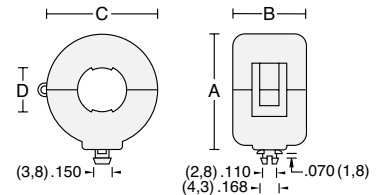

| PART No.  | A          | B          | C          | D         | IMPEDANCE IN OHMS |
|-----------|------------|------------|------------|-----------|-------------------|
| CF28B1642 | .852 21,6  | .885 22,5  | .840 21,3  | .282 7,2  | 100 @ 100MHz      |
| CF28B1805 | 1.040 26,4 | .667 16,9  | 1.025 26,4 | .340 8,6  | 73 @ 100MHz       |
| CF28B1937 | 1.182 30,0 | .780 19,8  | 1.188 30,2 | .425 10,8 | 117 @ 100MHz      |
| CF28B1984 | 1.218 30,9 | .705 17,9  | 1.220 31,0 | .525 13,3 | 62 @ 100MHz       |
| CF28B1501 | 1.725 43,8 | 1.232 31,3 | 1.720 43,7 | .710 18,0 | 177 @ 100MHz      |
| CF28B1500 | 1.725 43,8 | 1.232 31,3 | 1.720 43,7 | .960 24,4 | 133 @ 100MHz      |
| CF28B2000 | 2.350 59,7 | 1.851 47,0 | 2.309 58,6 | .960 24,4 | 380 @ 100MHz      |



**cable snap**

**WITH ADHESIVE MOUNT BASE.** Ferrite assembly in fully enclosed nylon case; various sizes are functional with wires and cables up to a 1.0" (25,4mm) diameter. After closing around wire and clasping shut, assembly is ready for mounting. Installs by removing protective paper strip from base and pressing into place.

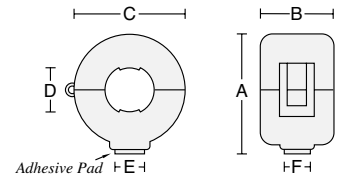

| PART No.  | A          | B          | C          | D         | E          | F          | IMPEDANCE IN OHMS |
|-----------|------------|------------|------------|-----------|------------|------------|-------------------|
| CA28B1642 | .882 22,4  | .885 22,5  | .840 21,3  | .282 7,2  | .375 9,5   | .375 9,5   | 100 @ 100MHz      |
| CA28B1805 | 1.070 27,2 | .667 16,9  | 1.025 26,4 | .340 8,6  | .375 9,5   | .375 9,5   | 73 @ 100MHz       |
| CA28B1937 | 1.212 30,8 | .780 19,8  | 1.188 30,2 | .425 10,8 | .375 9,5   | .375 9,5   | 117 @ 100MHz      |
| CA28B1984 | 1.248 31,7 | .705 17,9  | 1.220 31,0 | .525 13,3 | .375 9,5   | .375 9,5   | 62 @ 100MHz       |
| CA28B1501 | 1.755 44,6 | 1.232 31,3 | 1.720 43,7 | .710 18,0 | .875 22,2  | .875 22,2  | 177 @ 100MHz      |
| CA28B1500 | 1.755 44,6 | 1.232 31,3 | 1.720 43,7 | .960 24,4 | .875 22,2  | .875 22,2  | 133 @ 100MHz      |
| CA28B2000 | 2.380 60,5 | 1.851 47,0 | 2.309 58,6 | .960 24,4 | 1.000 25,4 | 1.500 38,1 | 380 @ 100MHz      |



**cable snap**

**WITH SCREW MOUNT BASE.** Ferrite assembly in fully enclosed nylon case; various sizes are functional with wires and cables up to a 1.0" (25,4mm) diameter. Mounting base press-fits into receptacle on bottom. Installs at the intended location with a screw through the .125" (3,2 mm) diameter hole provided. The base may be positioned at 90° increments relative to the upper case to provide four alternative assembly configurations.

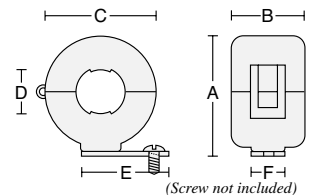

| PART No.  | A          | B          | C          | D         | E          | F        | IMPEDANCE IN OHMS |
|-----------|------------|------------|------------|-----------|------------|----------|-------------------|
| CW28B1642 | .916 23,3  | .885 22,5  | .840 21,3  | .282 7,2  | 1.250 31,8 | .375 9,5 | 100 @ 100MHz      |
| CW28B1805 | 1.105 28,1 | .667 16,9  | 1.025 26,4 | .340 8,6  | 1.250 31,8 | .375 9,5 | 73 @ 100MHz       |
| CW28B1937 | 1.236 31,4 | .780 19,8  | 1.188 30,2 | .425 10,8 | 1.250 31,8 | .375 9,5 | 117 @ 100MHz      |
| CW28B1984 | 1.282 32,6 | .705 17,9  | 1.220 31,0 | .525 13,3 | 1.250 31,8 | .375 9,5 | 62 @ 100MHz       |
| CW28B1501 | 1.789 45,5 | 1.232 31,3 | 1.720 43,7 | .710 18,0 | 1.250 31,8 | .375 9,5 | 177 @ 100MHz      |
| CW28B1500 | 1.789 45,5 | 1.232 31,3 | 1.720 43,7 | .960 24,4 | 1.250 31,8 | .375 9,5 | 133 @ 100MHz      |
| CW28B2000 | 2.414 61,3 | 1.851 47,0 | 2.309 58,6 | .960 24,4 | 1.250 31,8 | .375 9,5 | 380 @ 100MHz      |



**cable snap**

**WITH VARIABLE DIAMETER END PORTS.** Ferrite assembly in fully enclosed nylon case; various sizes are functional with wires and cables up to a .500 (12,7 mm) diameter. End ports are surrounded with flexible spring flutes to grip a range of cable diameters from .120" to .500" (3,2 to 12,7 mm). The grip-locking action prevents lateral movement along the cable or wire bundle.

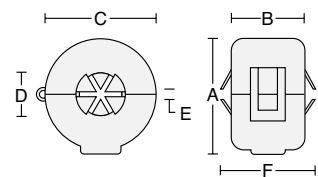

Patent No. 5,003,278

| PART No.  | A          | B         | C          | D         | E        | F (ref.)   | IMPEDANCE IN OHMS |
|-----------|------------|-----------|------------|-----------|----------|------------|-------------------|
| CV28B1642 | .852 21,6  | .885 22,5 | .840 21,3  | .282 7,2  | .120 3,0 | 1.020 25,9 | 100 @ 100MHz      |
| CV28B1805 | 1.040 26,4 | .667 16,9 | 1.025 26,4 | .340 8,6  | .120 3,0 | .820 20,8  | 73 @ 100MHz       |
| CV28B1937 | 1.182 30,0 | .780 19,8 | 1.188 30,2 | .375 9,5  | .120 3,0 | .950 24,1  | 117 @ 100MHz      |
| CV28B1984 | 1.218 30,9 | .705 17,9 | 1.220 31,0 | .500 12,7 | .120 3,0 | .940 23,9  | 62 @ 100MHz       |



**cable snap**

Ferrite assembly in fully enclosed nylon case; functional with wires and cables up to a .520" (13,2mm) diameter. Snap closed around wire by clasp shut to position assembly. Cable tie-wraps may be threaded through the loops on each side.

Larger I.D.'s permit multiple cable turns for greater impedance effect. See page 6, figures 3 and 4.

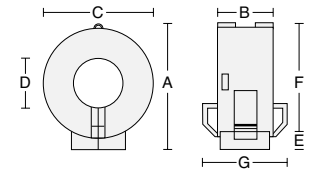

| PART No.  | A          | B         | C          | D         | E        | F          | G          | IMPEDANCE IN OHMS |
|-----------|------------|-----------|------------|-----------|----------|------------|------------|-------------------|
| CS28B0642 | .923 23,4  | .708 18,0 | .780 19,8  | .300 7,6  | .143 3,6 | .818 20,8  | 1.000 25,4 | 100 @ 100MHz      |
| CS28B0805 | 1.095 27,8 | .476 12,1 | .965 24,5  | .345 8,8  | .100 2,5 | 1.003 25,5 | .890 22,6  | 73 @ 100MHz       |
| CS28B0937 | 1.222 31,0 | .691 17,6 | 1.078 27,4 | .425 10,8 | .098 2,5 | 1.116 28,3 | .930 23,6  | 117 @ 100MHz      |
| CS28B0984 | 1.275 32,3 | .547 13,9 | 1.145 29,1 | .525 13,3 | .095 2,4 | 1.183 30,0 | .867 22,0  | 62 @ 100MHz       |



**cable snap**

**WITH PRESS FIT MOUNT.** Ferrite assembly in fully enclosed nylon case; various sizes are functional with wires and cables up to a .520" (13,2mm) diameter. After closing around wire and clasping shut, assembly snap-fits into mounting base. Base may be installed either before or after product assembly by pressing the integral spring tab fastener into a .187" (4,7mm) diameter hole.

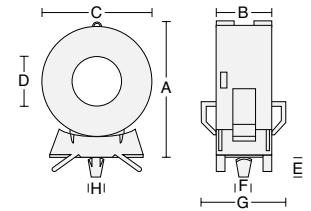

| PART No.  | A          | B         | C          | D         | E        | F        | G          | H        | IMPEDANCE IN OHMS |
|-----------|------------|-----------|------------|-----------|----------|----------|------------|----------|-------------------|
| CF28B0642 | .995 25,2  | .708 18,0 | .780 19,8  | .300 7,6  | .280 7,1 | .183 4,6 | 1.000 25,4 | .240 6,1 | 100 @ 100MHz      |
| CF28B0805 | 1.180 30,0 | .476 12,1 | .965 24,5  | .345 8,8  | .280 7,1 | .183 4,6 | .890 22,6  | .240 6,1 | 73 @ 100MHz       |
| CF28B0937 | 1.293 32,8 | .691 17,6 | 1.078 27,4 | .425 10,8 | .280 7,1 | .183 4,6 | .930 23,6  | .240 6,1 | 117 @ 100MHz      |
| CF28B0984 | 1.360 34,5 | .547 13,9 | 1.145 29,1 | .525 13,3 | .280 7,1 | .183 4,6 | .867 22,0  | .240 6,1 | 62 @ 100MHz       |



**cable snap**

**WITH ADHESIVE MOUNTING BASE.** Ferrite assembly in fully enclosed nylon case; various sizes are functional with wires and cables up to a .520" (13,2mm) diameter. After closing around wire and clasping shut, assembly is snap-fitted into its mounting base. May be installed in its intended location before or after product assembly simply by removing protective paper strip from base and pressing into place.

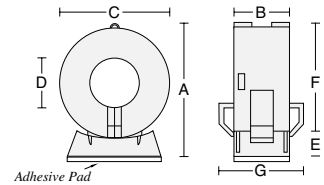

| PART No.  | A          | B         | C          | D         | E        | F          | G          | IMPEDANCE IN OHMS |
|-----------|------------|-----------|------------|-----------|----------|------------|------------|-------------------|
| CA28B0642 | .995 25,2  | .708 18,0 | .780 19,8  | .300 7,6  | .177 4,5 | .818 20,8  | 1.000 25,4 | 100 @ 100MHz      |
| CA28B0805 | 1.180 30,0 | .476 12,1 | .965 24,5  | .345 8,8  | .177 4,5 | 1.003 25,5 | .890 22,6  | 73 @ 100MHz       |
| CA28B0937 | 1.293 32,8 | .691 17,6 | 1.078 27,4 | .425 10,8 | .177 4,5 | 1.116 28,3 | .930 23,6  | 117 @ 100MHz      |
| CA28B0984 | 1.360 34,5 | .547 13,9 | 1.145 29,1 | .525 13,3 | .177 4,5 | 1.183 30,0 | .867 22,0  | 62 @ 100MHz       |



**cable snap**

**WITH SCREW MOUNT BASE.** Ferrite assembly in fully enclosed nylon case; various sizes are functional with wires and cables up to a .520" (13,2mm) diameter. Mounting base is pre-installed at the intended location with a screw through the .125" (3,2mm) diameter hole in the bottom. After closing around wire and clasping shut, assembly snap-fits into base.

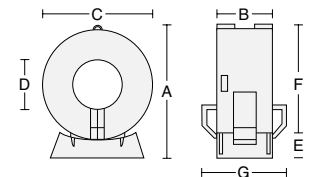

| PART No.  | A          | B         | C          | D         | E        | F          | G          | IMPEDANCE IN OHMS |
|-----------|------------|-----------|------------|-----------|----------|------------|------------|-------------------|
| CW28B0642 | .995 25,2  | .708 18,0 | .780 19,8  | .300 7,6  | .177 4,5 | .818 20,8  | 1.000 25,4 | 100 @ 100MHz      |
| CW28B0805 | 1.180 30,0 | .476 12,1 | .965 24,5  | .345 8,8  | .177 4,5 | 1.003 25,5 | .890 22,6  | 73 @ 100MHz       |
| CW28B0937 | 1.293 32,8 | .691 17,6 | 1.078 27,4 | .425 10,8 | .177 4,5 | 1.116 28,3 | .930 23,6  | 117 @ 100MHz      |
| CW28B0984 | 1.360 34,5 | .547 13,9 | 1.145 29,1 | .525 13,3 | .177 4,5 | 1.183 30,0 | .867 22,0  | 62 @ 100MHz       |



**cable clamp**

Ferrite assembly bonded to nylon strap; functional with wires and cables up to a 1.00" (25,4 mm) diameter. Holes are provided for screw mounting.

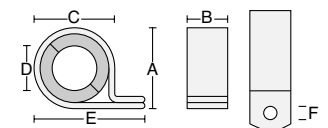

| PART No.  | A          | B          | C          | D          | E          | F        | IMPEDANCE IN OHMS |
|-----------|------------|------------|------------|------------|------------|----------|-------------------|
| TC28B0550 | .685 17,4  | 1.105 28,1 | .685 17,4  | .214 5,4   | 1.102 28,0 | .195 5,0 | 281 @ 100MHz      |
| TC28B0617 | .740 18,8  | 1.125 28,6 | .740 18,8  | .276 7,0   | 1.215 30,9 | .195 5,0 | 273 @ 100MHz      |
| TC28B0642 | .785 19,9  | .630 16,0  | .785 19,9  | .320 8,1   | 1.335 33,9 | .195 5,0 | 100 @ 100MHz      |
| TC28B0805 | .948 24,1  | .500 12,7  | .948 24,1  | .404 10,3  | 1.498 38,0 | .195 5,0 | 73 @ 100MHz       |
| TC28B0937 | 1.127 28,6 | .551 14,0  | 1.127 28,6 | .449 11,4  | 1.677 42,6 | .195 5,0 | 117 @ 100MHz      |
| TC28B1123 | 1.320 33,5 | 1.125 28,6 | 1.320 33,5 | .543 13,8  | 2.000 50,8 | .195 5,0 | 220 @ 100MHz      |
| TC28B0984 | 1.127 28,6 | .500 12,7  | 1.127 28,6 | .591 15,0  | 1.677 42,6 | .195 5,0 | 62 @ 100MHz       |
| TC28B1251 | 1.375 34,9 | .875 22,2  | 1.375 34,9 | .750 19,1  | 1.884 47,9 | .195 5,0 | 138 @ 100MHz      |
| TC28B1501 | 1.628 41,4 | 1.000 25,4 | 1.628 41,4 | .750 19,1  | 2.150 55,5 | .195 5,0 | 177 @ 100MHz      |
| TC28B1500 | 1.628 41,4 | 1.000 25,4 | 1.628 41,4 | 1.000 25,4 | 2.150 55,5 | .195 5,0 | 133 @ 100MHz      |
| TC28B2000 | 2.125 54,0 | 1.500 38,1 | 2.125 54,0 | 1.000 25,4 | 2.860 72,6 | .281 7,1 | 380 @ 100MHz      |



### sleeve snap



Box-shaped ferrite assembly in enclosed nylon case. Various sizes are functional with wires up to .500" (12,7 mm) diameter. Simply clamp around cable or wire; plastic tabs at entry/exit ports apply pressure to cable surface to maintain mounting position. Options include foam adhesive pad on bottom.

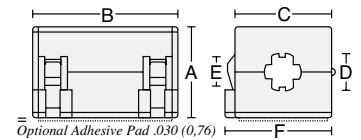

Available in standard colors gray (i.e., SS28B2031) and black (i.e., SS28B2031K)

Patent No. 5,764,125

| PART No.  | w/ Adhesive | A          | B          | C          | D         | E         | F          | IMPEDANCE IN OHMS |
|-----------|-------------|------------|------------|------------|-----------|-----------|------------|-------------------|
| SS28B2027 | AS28B2027   | .420 10,7  | .468 11,9  | .468 11,9  | .106 2,7  | .072 1,8  | .468 11,9  | 105 @ 100MHz      |
| SS28B2031 | AS28B2031   | .700 17,8  | 1.255 31,9 | .675 17,1  | .230 5,8  | .187 4,7  | .768 19,5  | 200 @ 100MHz      |
| SS28B2030 | AS28B2030   | .790 20,1  | 1.265 32,1 | .770 19,6  | .270 6,9  | .220 5,6  | .885 22,5  | 200 @ 100MHz      |
| SS28B2033 | AS28B2033   | .790 20,1  | 1.265 32,1 | .770 19,6  | .350 8,8  | .290 7,4  | .885 22,5  | 200 @ 100MHz      |
| SS28B2036 | AS28B2036   | 1.155 29,3 | 1.250 31,8 | 1.125 28,6 | .415 10,5 | .350 8,9  | 1.230 31,2 | 230 @ 100MHz      |
| SS28B2041 | AS28B2041   | .965 24,5  | 1.285 32,6 | .930 23,6  | .450 11,4 | .380 9,7  | 1.035 26,3 | 238 @ 100MHz      |
| SS28B2040 | AS28B2040   | 1.155 29,3 | 1.250 31,8 | 1.125 28,6 | .550 14,0 | .480 12,2 | 1.230 31,2 | 230 @ 100MHz      |

### sleeve snap for cable bundles



Box-shaped ferrite assembly for cable bundle diameters up to .730" (18,5mm) diameter. Allows single location for RFI suppression for multiple cables. Each circuit reacts separately with the suppression material without saturation. Alternatively, multiple turns of a single cable greatly increases impedance depending on frequency - see page 6, figures 3 and 4. Optional adhesive mount base.

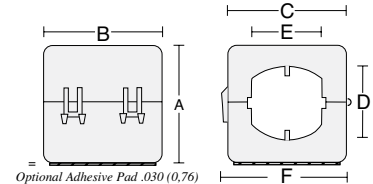

For optional variable diameter end port version with flexible spring flutes, see part numbers SS28B2044 and AS28B2044 in the photo below.

SS28B2035 available in standard colors gray (SS28B2035) and black (SS28B2035K)

| PART No.  | w/ Adhesive | A          | B          | C          | D         | E         | F          | IMPEDANCE IN OHMS |
|-----------|-------------|------------|------------|------------|-----------|-----------|------------|-------------------|
| SS28B2035 | AS28B2035   | 1.155 29,3 | 1.250 31,8 | 1.125 28,6 | .790 20,1 | .720 18,3 | 1.230 31,2 | 129 @ 100MHz      |
| SS28B2043 | AS28B2043   | 1.700 43,2 | 1.780 45,2 | 1.800 45,7 | .790 20,1 | .720 18,3 | 1.830 46,5 | 260 @ 100MHz      |

### sleeve snap

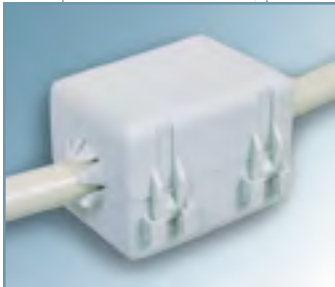

**WITH VARIABLE DIAMETER END PORTS.** Box-shaped ferrite assembly in fully enclosed nylon case. End ports are surrounded with flexible spring flutes to grip a range of cable diameters from .125" to .730" (3,2 to 18,5 mm). Special mounting options include foam adhesive pad on bottom.

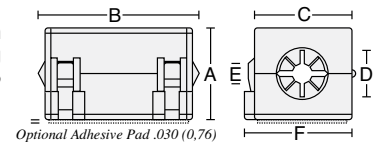

Available in standard colors gray (i.e., SS28B2034) and black (i.e., SS28B2034K)

Patent No. 5,003,278 and Patent No. 5,764,125

| PART No.  | w/ Adhesive | A          | B (ref.)   | C          | D         | E        | F          | IMPEDANCE IN OHMS |
|-----------|-------------|------------|------------|------------|-----------|----------|------------|-------------------|
| SS28B2034 | AS28B2034   | .585 14,9  | 1.250 31,8 | .585 14,9  | .250 6,4  | .120 3,0 | .680 17,3  | 220 @ 100MHz      |
| SS28B2037 | AS28B2037   | .790 20,1  | 1.450 36,8 | .770 19,6  | .350 8,8  | .200 5,1 | .885 22,5  | 200 @ 100MHz      |
| SS28B2042 | AS28B2042   | .965 24,5  | 1.480 37,6 | .930 23,6  | .425 10,8 | .170 4,3 | 1.035 26,3 | 238 @ 100MHz      |
| SS28B2032 | AS28B2032   | 1.155 29,3 | 1.450 36,8 | 1.125 28,6 | .500 12,7 | .200 5,1 | 1.230 31,2 | 230 @ 100MHz      |
| SS28B2044 | AS28B2044   | 1.700 43,2 | 1.800 45,7 | 1.800 45,7 | .790 20,1 | .200 5,1 | 1.830 46,5 | 260 @ 100MHz      |

### internal locking snap



**WITH SECURE INTERNAL LOCKING SYSTEM.** Cannot be reopened after snapping closed into position. Ensures that suppressor cannot be removed. Grip-lock tabs at entry/exit ports prevent longitudinal slippage on a range of cable diameters from .275" to .300" (7,0 to 7,6mm). Standard colors are computer gray (PMS#413), computer beige (PMS#468), black and natural white. A cost-effective alternative to over-molding.

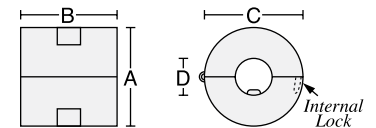

Patent Nos. 5,003,278 , 5,162,772 and 5,764,125

| PART No.   | A         | B (ref.)  | C         | D        | COLOR          | IMPEDANCE IN OHMS |
|------------|-----------|-----------|-----------|----------|----------------|-------------------|
| IL28B0642W | .780 19,8 | .780 19,8 | .780 19,8 | .316 8,0 | NATURAL WHITE  | 100 @ 100MHz      |
| IL28B0642G | .780 19,8 | .780 19,8 | .780 19,8 | .316 8,0 | COMPUTER GRAY  | 100 @ 100MHz      |
| IL28B0642B | .780 19,8 | .780 19,8 | .780 19,8 | .316 8,0 | COMPUTER BEIGE | 100 @ 100MHz      |
| IL28B0642K | .780 19,8 | .780 19,8 | .780 19,8 | .316 8,0 | BLACK          | 100 @ 100MHz      |

### jelly bean snap



**MINIATURE SIZE WITH INTERNAL LOCKING SYSTEM.** Cannot be reopened after snapping closed into position. Ensures that suppressor cannot be removed. Grip-lock tabs at entry/exit ports prevent longitudinal slippage on a range of cable diameters from .060" to .120" (1,5 to 3,0mm).

Excellent for tight spaces and low profile applications. A cost-effective alternative to "molded-in" suppressors, shrink tubing, tie wraps, taping and other secondary installation operations.

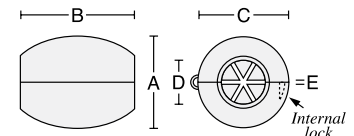

Available in standard color gray

Patent Nos. 5,003,278 , 5,162,772 and 5,764,125

| PART No.  | A         | B         | C         | D        | E        | IMPEDANCE IN OHMS |
|-----------|-----------|-----------|-----------|----------|----------|-------------------|
| JB28B0010 | .670 17,0 | .820 20,8 | .670 17,0 | .290 7,4 | .055 1,4 | 160 @ 100MHz      |

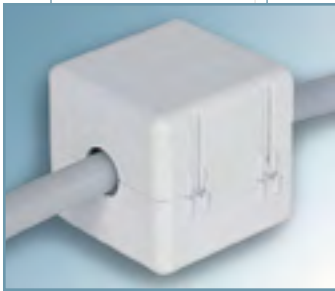

### high impedance sleeve snap

**WITH OPTIONAL MOUNTING BASES.**

High impedance ferrite assembly for large scale applications containing high data rates and microprocessor harmonics/spurious signals well beyond the operating frequency. Excellent for telecommunications switching applications, local area networks (LANs) and distribution system integration. The basic version simply clamps into position around cables and wiring. May also be mounted with a flat-head screw through the .120" (3,0mm) diameter hole in the bottom by temporarily removing lower ferrite half.

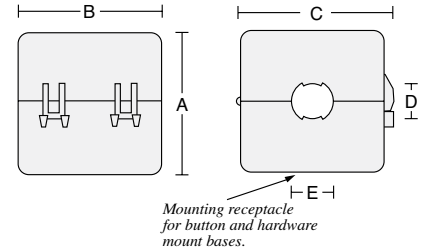

Other mounting options include a foam adhesive base, a button mount base sized for a .150" (3.8 mm) diameter hole, and a hardware mounting plate for screw or rivet attachment. The adhesive mount base and button mount base options are preassembled. The hardware mounting base may be press-fitted into the receptacle on the bottom of the case during installation in one of four positions at 90° increments for alternative assembly configurations.

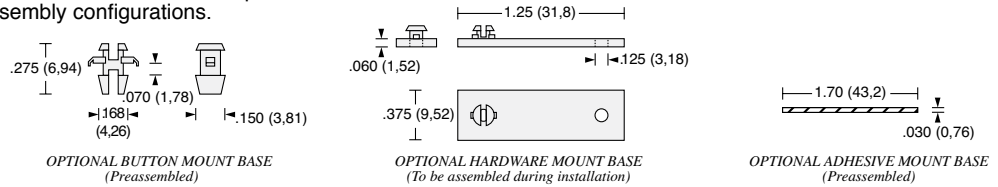

| PART No.  | Description    | A     | B    | C     | D    | E     | IMPEDANCE IN OHMS        |              |
|-----------|----------------|-------|------|-------|------|-------|--------------------------|--------------|
| HI28B2038 | Basic          | 1.700 | 43,2 | 1.780 | 45,2 | 1.800 | 45,7 .428 10,9 .468 11,9 | 410 @ 100MHz |
| HF28B2038 | Button Mount   | 1.700 | 43,2 | 1.780 | 45,2 | 1.800 | 45,7 .428 10,9 .468 11,9 | 410 @ 100MHz |
| HW28B2038 | Hardware Mount | 1.700 | 43,2 | 1.780 | 45,2 | 1.800 | 45,7 .428 10,9 .468 11,9 | 410 @ 100MHz |
| HA28B2038 | Adhesive Mount | 1.700 | 43,2 | 1.780 | 45,2 | 1.800 | 45,7 .428 10,9 .468 11,9 | 410 @ 100MHz |

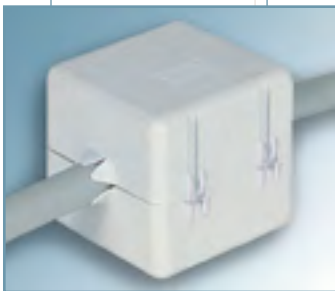

### high impedance sleeve snap

**WITH VARIABLE DIAMETER END PORTS AND OPTIONAL MOUNTING BASES.**

High impedance ferrite assembly with exactly the same characteristics as the high impedance sleeve snaps above, except that the entry/exit end ports are surrounded with flexible spring flutes to grip a range of cable diameters from .250" to .435" (6,4 to 11,0mm). Excellent for telecommunications switching applications, local area networks (LANs) and distribution system integration. The basic version simply clamps into position around cables and wiring. May also be mounted with a flat-head screw through the .120" (3,0mm) diameter hole in the bottom by temporarily removing lower ferrite half.

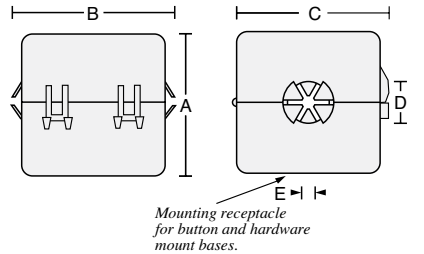

Other mounting options include a foam adhesive base, a button mount base sized for a .150" (3.8mm) diameter hole, and a hardware mounting plate for screw or rivet attachment. The adhesive mount base and button mount base options are preassembled. The hardware mounting base may be press-fitted into the receptacle on the bottom of the case during installation in one of four positions at 90° increments for alternative assembly configurations.

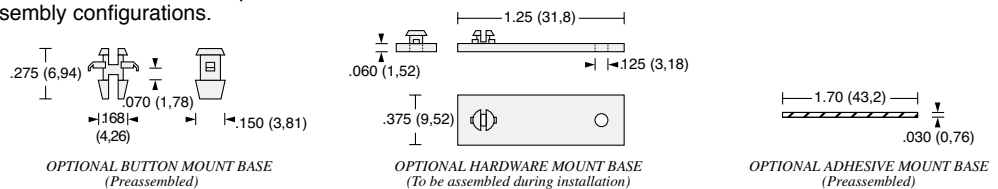

| PART No.  | Description    | A     | B (ref.) | C     | D    | E     | IMPEDANCE IN OHMS        |              |
|-----------|----------------|-------|----------|-------|------|-------|--------------------------|--------------|
| HI28B2039 | Basic          | 1.700 | 43,2     | 2.000 | 50,8 | 1.800 | 45,7 .500 12,7 .140 3,55 | 410 @ 100MHz |
| HF28B2039 | Button Mount   | 1.700 | 43,2     | 2.000 | 50,8 | 1.800 | 45,7 .500 12,7 .140 3,55 | 410 @ 100MHz |
| HW28B2039 | Hardware Mount | 1.700 | 43,2     | 2.000 | 50,8 | 1.800 | 45,7 .500 12,7 .140 3,55 | 410 @ 100MHz |
| HA28B2039 | Adhesive Mount | 1.700 | 43,2     | 2.000 | 50,8 | 1.800 | 45,7 .500 12,7 .140 3,55 | 410 @ 100MHz |



### USB cable sleeve snap

**WITH VARIABLE DIAMETER END PORTS.** Specifically sized to fit the range of common USB I/O cable diameters; variable diameter end ports allow for different types of cable insulation covers measuring .125" to .179" (3,0 - 4,5mm).

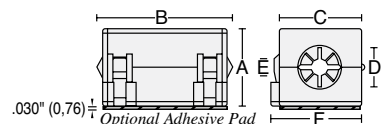

Simple snap-on installation. Available with optional adhesive pad on bottom, and in standard gray (PMS #413) and black colors.

For use with USB I/O USB 2.0 Electrical Test Specification, sections 7.0 and 8.0

| PART No.    | w/Adhesive   | A    | B    | C     | D    | E    | F    | COLOR                       | IMPEDANCE IN OHMS  |
|-------------|--------------|------|------|-------|------|------|------|-----------------------------|--------------------|
| USB28B2034  | USB28B2034A  | .585 | 14,9 | 1.250 | 31,8 | .585 | 14,9 | .250 6,4 .120 3,0 .680 17,3 | gray 220 @ 100MHz  |
| USB28B2034K | USB28B2034KA | .585 | 14,9 | 1.250 | 31,8 | .585 | 14,9 | .250 6,4 .120 3,0 .680 17,3 | black 220 @ 100MHz |



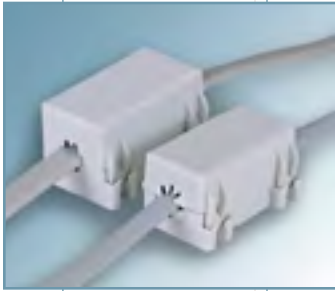

### telecom cable snaps

WITH END PORTS FOR FLAT-OVAL CABLES. Box-shaped ferrite assembly in fully enclosed nylon case. Two sizes: one for 4-conductor and one for 6-conductor standard telecom flat-oval cable. Clamps around cable with appropriate pressure to maintain desired position.

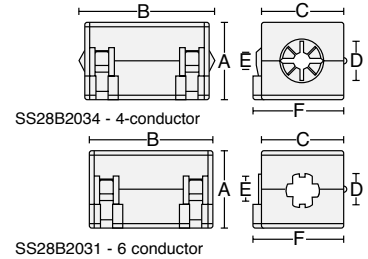

Available in standard colors gray (i.e., SS28B2034) and black (i.e., SS28B2034K)  
 Patent Nos. 5,003,278 and 5,764,125

| PART No.  | Cable Size  | A    | B    | C     | D    | E    | F    | IMPEDANCE IN OHMS                        |
|-----------|-------------|------|------|-------|------|------|------|--|
| SS28B2034 | 4 conductor | .585 | 14,9 | 1.250 | 31,8 | .585 | 14,9 | .250 6,4 .120 3,0 .680 17,3 220 @ 100MHz |
| SS28B2031 | 6 conductor | .700 | 17,8 | 1.255 | 31,9 | .675 | 17,1 | .230 5,8 .187 4,7 .768 19,5 200 @ 100MHz |



### very high impedance multi-turn sleeve snap

WITH SERPENTINE CABLE THREADING CAPABILITY.

By increasing the number of times the circuit passes through the ferrite core, the effective magnetic path is lengthened yielding a significant increase in impedance. See page 6, figures 3 and 4. The gain is equal to  $N^2$ , the square of the number of turns, and depending on the circuit cable load and frequencies involved, much of the increase can be realized.

Cables may be "looped back through" as shown at left; or, "looped over the top" as shown at left (insert).

In an alternate configuration, separate cable circuits can be accommodated without saturation. Three styles permit different approaches:

The 1-hole allows two passes of a cable with a diameter up to .365" (9,3mm) or three passes of a cable with a diameter up to .243" (6,2mm).

The 2-hole allows two passes of a cable with a diameter up to .335" (8,5mm).

The 3-hole allows three passes of cable with a diameter up to .203" (5,8mm).

Each is available with an optional adhesive foam pad mounting base.

Available in standard colors gray (i.e., SS28B2035) and black (i.e., SS28B2035K)  
 Patent No. 5,003,278

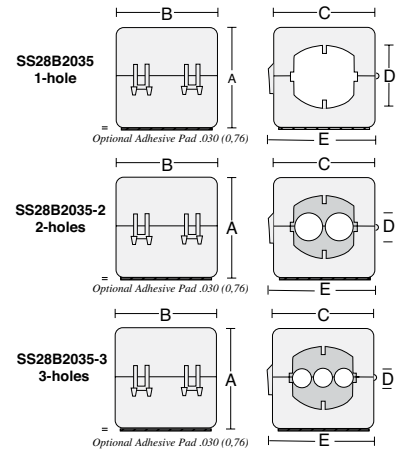

| PART No.    | w/Adhesive  | Description | A     | B    | C     | D    | E                               | IMPEDANCE IN OHMS ref.                          |
|-------------|-------------|-------------|-------|------|-------|------|---------------------------------|---|
| SS28B2035   | AS28B2035   | 1-hole      | 1.155 | 29,3 | 1.250 | 31,8 | 1.125 28,6 .780 19,8 1.230 31,2 | 1N=129* 2N=2 <sup>2</sup> =4NΩ ref.             |
| SS28B2035-2 | AS28B2035-2 | 2-hole      | 1.155 | 29,3 | 1.250 | 31,8 | 1.125 28,6 .335 8,5 1.230 31,2  | 1N=270* 3N=3 <sup>2</sup> =9NΩ ref.             |
| SS28B2035-3 | AS28B2035-3 | 3-hole      | 1.155 | 29,3 | 1.250 | 31,8 | 1.125 28,6 .203 5,2 1.230 31,2  | 1N=340* depending on circuit load and frequency |

\* @ 100 MHz



### cable bundle clamp

WITH UNIVERSAL MOUNTING STRAP. For cable bundle diameters up to 1.00" (25,4mm). Allows single location for RFI suppression for multiple cables and wiring runs. Each circuit reacts independently with the suppression material without saturation. Adhesive mount base also provides a centered .203" (5,1mm) diameter hole for optional hardware attachment. Quick-release closure clip allows easy addition or removal of wires.

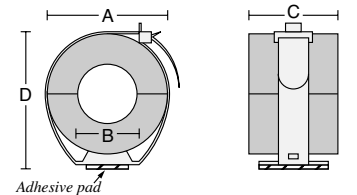

| PART No.  | w/ adhesive | A    | B    | C    | D    | IMPEDANCE IN OHMS                 |
|-----------|-------------|------|------|------|------|-----------------------------------|
| BC28B1251 | BA28B1251   | 1.38 | 35,1 | .75  | 19,1 | .875 22,2 1.71 41,7 138 @ 100MHz  |
| BC28B1501 | BA28B1501   | 1.63 | 41,4 | .75  | 19,1 | 1.000 25,4 1.96 48,0 177 @ 100MHz |
| BC28B1500 | BA28B1500   | 1.63 | 41,4 | 1.00 | 25,4 | 1.000 25,4 1.96 48,0 133 @ 100MHz |



### pre-molded sleeve

WITH INTERNAL FRICTION GRIP Exterior PVC sheath pre-molded over ferrite suppressor. Assembles to cable prior to termination by threading in one end and out the other. Neutral gray standard color. Five sizes accommodate cable diameters from .200" to .430" (5,1 to 10,9mm). The preferred alternative to cable over-molding, shrink tubing, taping, tie wraps and other costly secondary installation operations. A drop of water in the I.D. during assembly will facilitate sliding into position.

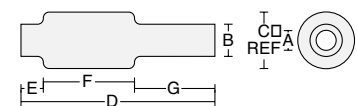

Patent No. 5,200,730

| PART No.  | A    | B    | C    | D    | E    | F    | G                                       | IMPEDANCE IN OHMS |
|-----------|------|------|------|------|------|------|---|-------------------|
| PM28B3375 | .192 | 4,8  | .290 | 7,4  | .465 | 11,8 | 2.01 51,1 .250 6,4 .960 24,4 .800 20,3  | 140 @ 100MHz      |
| PM28B0625 | .310 | 7,9  | .400 | 10,2 | .715 | 18,2 | 1.82 46,2 .250 6,4 .772 19,6 .800 20,3  | 120 @ 100MHz      |
| PM28B1625 | .310 | 7,9  | .400 | 10,2 | .715 | 18,2 | 2.38 60,5 .250 6,4 1.335 33,9 .800 20,3 | 225 @ 100MHz      |
| PM28B0686 | .375 | 9,5  | .465 | 11,8 | .776 | 19,7 | 2.38 60,5 .250 6,4 1.335 33,9 .800 20,3 | 196 @ 100MHz      |
| PM28B0736 | .430 | 10,9 | .520 | 13,2 | .776 | 19,7 | 2.38 60,5 .250 6,4 1.335 33,9 .800 20,3 | 176 @ 100MHz      |

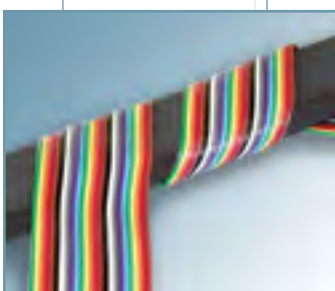

### special purpose shielding bar

For situations where extremely high amounts of attenuation are needed and/or multiple passes through a traditional ferrite I.D. are not practical or sufficient. Simply wrap cable in a spiral around bar for optimum absorption.

- One individual size fits most applications
- For round or flat cables wound axially or attached longitudinally
- Attachment with cable ties or optional adhesive pad
- Sandwiching cable between two bars provides up to three times the impedance of a single bar depending on frequency

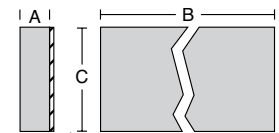

\* Optional Adhesive pad .030 (0,76)

| PART No.  | w/ adhesive | A    | B   | C           | IMPEDANCE IN OHMS                |
|-----------|-------------|------|-----|-------------|----------------------------------|
| SB28B5630 | SB28B5630A  | .365 | 9,3 | 5.630 143,0 | 1.00 25,4 one pass: 500 @ 100MHz |



### miniature beads

Very small cylindrical suppressors for wire diameters below .25" (6,4mm). Handy for tight spaces, on-board suppression and general applications.



| PART No.  | A     |      | B    |      | C    |     | IMPEDANCE IN OHMS |
|-----------|-------|------|------|------|------|-----|-------------------|
| 28B0137-3 | .500  | 12,7 | .138 | 3,5  | .051 | 1,3 | 153 @ 100MHz      |
| 28B0138-7 | .550  | 14,0 | .138 | 3,5  | .034 | 0,9 | 234 @ 100MHz      |
| 28B0200-4 | .900  | 22,9 | .200 | 5,1  | .062 | 1,6 | 318 @ 100MHz      |
| 28B0250-1 | .625  | 15,9 | .250 | 6,4  | .125 | 3,2 | 133 @ 100MHz      |
| 28B0300-0 | .200  | 5,1  | .300 | 7,6  | .069 | 1,8 | 93 @ 100MHz       |
| 28B0385-2 | .650  | 16,5 | .385 | 9,8  | .038 | 0,9 | 452 @ 100MHz      |
| 28B0350-0 | .625  | 15,9 | .343 | 8,7  | .170 | 4,3 | 102 @ 100MHz      |
| 28B0355-0 | .354  | 9,0  | .787 | 20,0 | .187 | 4,7 | 138 @ 100MHz      |
| 28B0375-3 | .750  | 19,1 | .375 | 9,5  | .192 | 4,8 | 140 @ 100MHz      |
| 28B0562-2 | 1.125 | 28,6 | .562 | 14,2 | .250 | 6,4 | 257 @ 100MHz      |



### large beads

Sizes up to 1.0" I.D. (25,4 mm) for applications where there are large cable bundles or where great amounts of suppression are required.

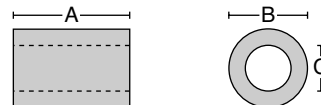

| PART No.  | A     |      | B     |      | C     |      | IMPEDANCE IN OHMS |
|-----------|-------|------|-------|------|-------|------|-------------------|
| 28B0563-0 | .600  | 15,2 | .562  | 14,2 | .286  | 7,3  | 124 @ 100MHz      |
| 28B0625-0 | .562  | 14,3 | .625  | 15,9 | .310  | 7,9  | 120 @ 100MHz      |
| 28B0625-1 | 1.125 | 28,6 | .625  | 15,9 | .310  | 7,9  | 225 @ 100MHz      |
| 28B0626-0 | .625  | 15,9 | .626  | 16,0 | .133  | 3,4  | 300 @ 100MHz      |
| 28B0672-0 | .672  | 17,1 | 1.000 | 25,4 | .345  | 8,6  | 182 @ 100MHz      |
| 28B0672-1 | 1.000 | 25,4 | .672  | 17,1 | .345  | 8,6  | 182 @ 100MHz      |
| 28B0686-2 | 1.125 | 28,6 | .686  | 17,4 | .375  | 9,5  | 196 @ 100MHz      |
| 28B0735-0 | 1.125 | 28,6 | .735  | 18,7 | .400  | 10,2 | 188 @ 100MHz      |
| 28B0736-0 | 1.125 | 28,6 | .736  | 18,7 | .430  | 10,9 | 176 @ 100MHz      |
| 28B1020-1 | 1.125 | 28,6 | 1.020 | 25,9 | .505  | 12,8 | 225 @ 100MHz      |
| 28B1102-1 | 1.000 | 25,4 | 1.102 | 27,9 | .620  | 15,7 | 147 @ 100MHz      |
| 28B1250-2 | 1.000 | 25,4 | 1.250 | 31,8 | .750  | 19,1 | 151 @ 100MHz      |
| 28B1387-1 | 1.000 | 25,4 | 1.387 | 35,2 | .882  | 22,4 | 142 @ 100MHz      |
| 28B2000-3 | 2.000 | 50,8 | 2.000 | 50,8 | 1.000 | 25,4 | 381 @ 100MHz      |



### toroids

Cables can many times be assembled through the larger center opening even with connectors and plugs installed beforehand. Multiple cable turns through the center yield greater suppression and the flexibility to fine-tune a circuit. Up to 1.400" (35,6mm) I.D.

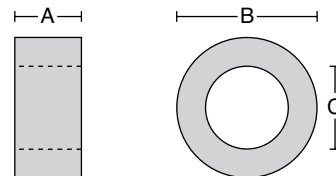

| PART No.  | A    |      | B     |      | C     |      | IMPEDANCE IN OHMS    |
|-----------|------|------|-------|------|-------|------|----------------------|
| 28B0870-0 | .250 | 6,4  | .870  | 22,1 | .540  | 13,7 | One Pass 25 @ 100MHz |
| 28B0999-0 | .500 | 12,7 | 1.000 | 25,4 | .610  | 15,5 | One Pass 83 @ 100MHz |
| 28B1225-0 | .612 | 15,5 | 1.225 | 31,1 | .750  | 19,1 | One Pass 97 @ 100MHz |
| 28B1417-2 | .500 | 12,7 | 1.417 | 36,0 | .905  | 23,0 | One Pass 89 @ 100MHz |
| 28B2400-0 | .500 | 12,7 | 2.400 | 61,0 | 1.400 | 35,6 | One Pass 88 @ 100MHz |

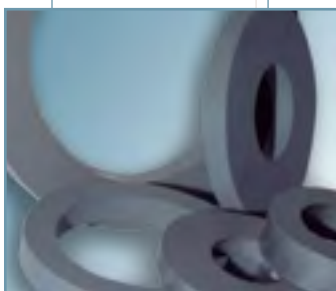

### extra large toroids

WITH INSIDE DIAMETERS FROM 1.33" TO 6.66" (33.8 to 167 mm). Very large toroids for special purpose applications available in #28 material as shown below, and in #25 material.

Special order only; available by quotation. Please contact customer service with quantity information. Some items in stock.

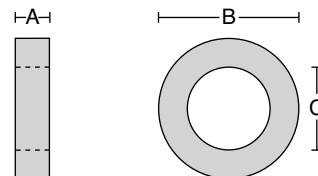

| PART No. | A     |      | B     |       | C     |       | IMPEDANCE IN OHMS |
|----------|-------|------|-------|-------|-------|-------|-------------------|
| 28B2275  | .500  | 12,7 | 2.275 | 57,8  | 1.335 | 33,9  | Per Application   |
| 28B2945  | .500  | 12,7 | 2.945 | 74,8  | 1.775 | 45,1  | Per Application   |
| 28B3170  | .500  | 12,7 | 3.170 | 80,5  | 1.645 | 41,8  | Per Application   |
| 28B4100  | .500  | 12,7 | 4.100 | 104,1 | 2.650 | 67,3  | Per Application   |
| 28B5945  | .500  | 12,7 | 5.885 | 149,4 | 4.275 | 108,6 | Per Application   |
| 28B5950  | .500  | 12,7 | 5.885 | 149,4 | 3.675 | 93,3  | Per Application   |
| 28B9210  | 1.000 | 25,4 | 9.210 | 233,9 | 6.665 | 169,3 | Per Application   |

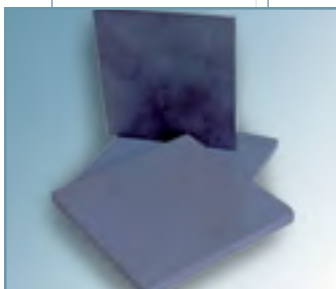

### square tiles

For purpose-built electronic enclosures and architectural full room lining, these designs permit optimum absorption with minimum reflection. Very effective when used just in the corners of shielded rooms to dampen the effects of sharp corners.

Special order only; available by quotation. Please contact customer service with quantity information. Some items in stock.

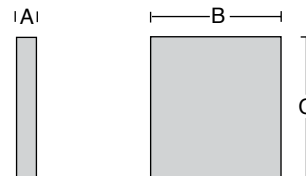

| PART No. | A    |     | B     |       | C     |       | IMPEDANCE IN OHMS |
|----------|------|-----|-------|-------|-------|-------|-------------------|
| 21T3350  | .248 | 6,3 | 3.350 | 85,0  | 3.350 | 85,0  | Per Application   |
| 21T3937  | .248 | 6,3 | 3.937 | 100,0 | 3.937 | 100,0 | Per Application   |
| 21T4335  | .248 | 6,3 | 4.335 | 110,0 | 4.335 | 110,0 | Per Application   |

### flat cable clamp

**WITH FULL OUTER ENCLOSURE.** Ferrite assembly in fully enclosed nylon case. Four sizes functional with flat cables up to 64-conductor widths. Internal grip-lock tabs apply pressure on cable to maintain mounting position.

May also be mounted with flat-head screws through the .120" (3,0mm) diameter holes on 1.25" (31,8mm) centers in the bottom by temporarily removing the lower ferrite half. Excellent for flex-circuits.

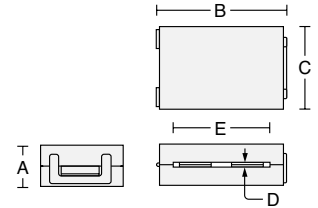

| PART No.  | A    | B    | C    | D     | E     | IMPEDANCE IN OHMS |                     |              |
|-----------|------|------|------|-------|-------|-------------------|---------------------|--------------|
| RC28B1729 | .670 | 17,0 | 2.03 | 51,6  | 1.312 | 33,3              | .060 1,5 1.355 34,4 | 200 @ 100MHz |
| RC28B2480 | .670 | 17,0 | 2.76 | 70,1  | 1.312 | 33,3              | .060 1,5 2.047 52,0 | 250 @ 100MHz |
| RC28B3012 | .670 | 17,0 | 3.26 | 82,8  | 1.312 | 33,3              | .060 1,5 2.540 64,5 | 286 @ 100MHz |
| RC28B4340 | .755 | 19,2 | 4.61 | 117,1 | 1.312 | 33,3              | .104 2,6 3.240 82,3 | 325 @ 100MHz |

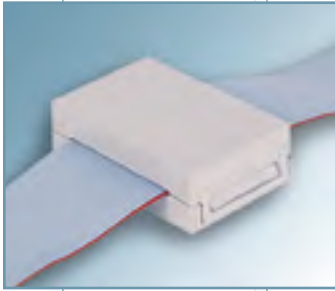

### flat cable clamp

**WITH FULL OUTER ENCLOSURE AND ADHESIVE MOUNT.** Ferrite assembly in fully enclosed nylon case. Four sizes functional with flat cables up to 64-conductor widths. Internal grip-lock tabs apply pressure on cable to maintain mounting position.

Installs easily on any mounting surface by removing liner from foam adhesive base pad. Excellent for flex-circuits.

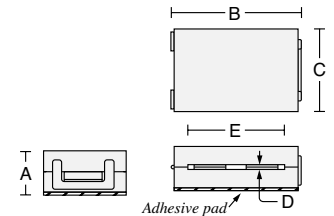

| PART No.  | A    | B    | C    | D     | E     | IMPEDANCE IN OHMS |                     |              |
|-----------|------|------|------|-------|-------|-------------------|---------------------|--------------|
| RA28B1729 | .700 | 17,8 | 2.03 | 51,6  | 1.312 | 33,3              | .060 1,5 1.355 34,4 | 200 @ 100MHz |
| RA28B2480 | .700 | 17,8 | 2.76 | 70,1  | 1.312 | 33,3              | .060 1,5 2.047 52,0 | 250 @ 100MHz |
| RA28B3012 | .700 | 17,8 | 3.26 | 82,8  | 1.312 | 33,3              | .060 1,5 2.540 64,5 | 286 @ 100MHz |
| RA28B4340 | .785 | 19,9 | 4.61 | 117,1 | 1.312 | 33,3              | .104 2,6 3.240 82,3 | 325 @ 100MHz |

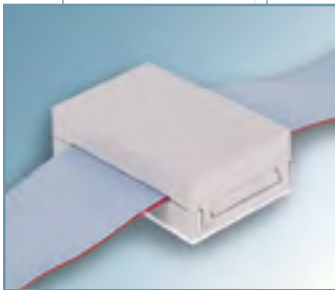

### low profile flat cable clamp

**SLIM-LINE FLAT CABLE CLAMP WITH CABLE GRIP OPENINGS.** Ferrite pair snaps together into the lowest profile nylon enclosure available. Three sizes accommodate flat cables up to 40-conductors. Internal grip-lock tabs maintain mounting position. Mounts also with flat-head screws through the .120" (3,0mm) diameter holes in the bottom by temporarily removing the lower ferrite half.

Excellent for flex-circuits.

1. Place cable over lower half.
2. Align tabs and pockets on one end.
3. Rotate top half onto bottom clipping both sides in one smooth motion.

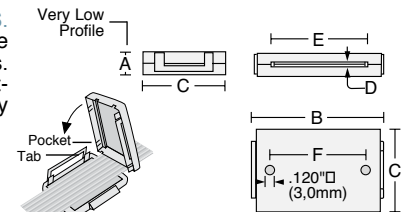

| PART No.  | A    | B   | C     | D    | E     | F    | IMPEDANCE IN OHMS               |              |
|-----------|------|-----|-------|------|-------|------|---------------------------------|--------------|
| RC28B0765 | .370 | 9,4 | 1.065 | 27,1 | 1.312 | 33,3 | .038 0,97 .547 13,9 .250 6,4    | 142 @ 100MHz |
| RC28B1265 | .370 | 9,4 | 1.560 | 39,6 | 1.312 | 33,3 | .038 0,97 1.047 26,6 .750 19,1  | 148 @ 100MHz |
| RC28B2265 | .370 | 9,4 | 2.560 | 65,0 | 1.312 | 33,3 | .038 0,97 2.047 52,0 1.750 44,5 | 154 @ 100MHz |

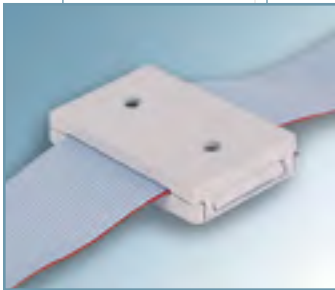

### low profile flat cable clamp

**SLIM-LINE FLAT CABLE CLAMP WITH CABLE GRIP OPENINGS AND ADHESIVE MOUNT.** Ferrite pair snaps together into the lowest profile nylon enclosure available. Three sizes accommodate flat cables up to 40-conductors. Internal grip-lock tabs apply pressure on cable to maintain mounting position. Installs easily on any mounting surface by removing liner from foam adhesive base pad.

Excellent for flex-circuits.

1. Place cable over lower half.
2. Align tabs and pockets on one end.
3. Rotate top half onto bottom clipping both sides in one smooth motion.

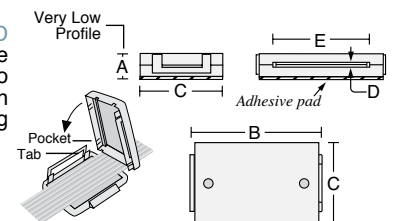

| PART No.  | A    | B    | C     | D    | E     | IMPEDANCE IN OHMS |                      |              |
|-----------|------|------|-------|------|-------|-------------------|----------------------|--------------|
| RA28B0765 | .400 | 10,2 | 1.065 | 27,1 | 1.312 | 33,3              | .038 0,97 .547 13,9  | 142 @ 100MHz |
| RA28B1265 | .400 | 10,2 | 1.560 | 39,6 | 1.312 | 33,3              | .038 0,97 1.047 26,6 | 148 @ 100MHz |
| RA28B2265 | .400 | 10,2 | 2.560 | 65,0 | 1.312 | 33,3              | .038 0,97 2.047 52,0 | 154 @ 100MHz |





### flat cable clamp

**WITH ADHESIVE MOUNT.** Ferrite assembly bonded in nylon mounting clamp; easily installed by peeling protective paper strip from base and pressing into place. Nine sizes accommodate all flat cables up to 50-conductor width.

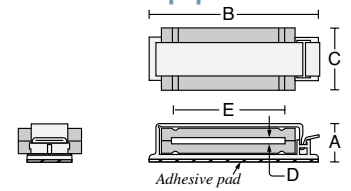

| PART No.  | w/o Adhesive | A         | B          | C          | D        | E          | IMPEDANCE IN OHMS |  |
|-----------|--------------|-----------|------------|------------|----------|------------|-------------------|--|
| FA28B0071 | FC28B0071    | .520 13,2 | 1.244 31,6 | .750 19,1  | .060 1,5 | .510 13,0  | 49 @ 100 MHz      |  |
| FA28B0121 | FC28B0121    | .520 13,2 | 1.790 45,5 | .750 19,1  | .060 1,5 | 1.010 25,7 | 97 @ 100 MHz      |  |
| FA28B1240 | FC28B1240    | .520 13,2 | 1.790 45,5 | 1.125 28,6 | .040 1,0 | 1.020 25,9 | 250 @ 100MHz      |  |
| FA28B1265 |              | .520 13,2 | 1.790 45,5 | 1.125 28,6 | .038 1,0 | 1.047 26,6 | 148 @ 100MHz      |  |
| FA28B1729 | FC28B1729    | .800 20,3 | 2.430 61,7 | 1.125 28,6 | .060 1,5 | 1.355 34,4 | 200 @ 100 MHz     |  |
| FA28B2265 |              | .520 13,2 | 3.000 80,8 | 1.125 28,6 | .038 1,0 | 2.047 52,0 | 154 @ 100 MHz     |  |
| FA28B2375 | FC28B2375    | .800 20,3 | 3.180 80,8 | 1.050 26,7 | .060 1,5 | 1.720 43,7 | 195 @ 100 MHz     |  |
| FA28B2480 | FC28B2480    | .800 20,3 | 3.180 80,8 | 1.125 28,6 | .060 1,5 | 2.047 52,0 | 250 @ 100 MHz     |  |
| FA28B3012 | FC28B3012    | .800 20,3 | 3.700 94,0 | 1.125 28,6 | .060 1,5 | 2.540 64,5 | 286 @ 100 MHz     |  |

### flat cable clamp

**WITH SINGLE PRESS FIT MOUNT.** Ferrite assembly bonded in nylon mounting clamp; easily installed by pressing the integral spring tab fastener into a .250" (6,4mm) diameter hole. Seven sizes accommodate all flat cables up to 50-conductor width. Fits substrates up to .070" (1,8mm) thickness.

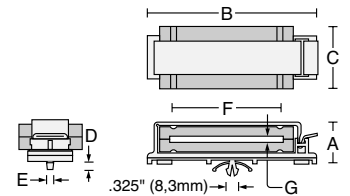

| PART No.  | A         | B          | C          | D        | E        | F          | G        | IMPEDANCE IN OHMS |  |
|-----------|-----------|------------|------------|----------|----------|------------|----------|-------------------|--|
| FF28B0121 | .475 12,7 | 1.790 45,5 | .750 19,1  | .325 8,3 | .240 6,1 | 1.010 25,7 | .060 1,5 | 97 @ 100MHz       |  |
| FF28B1240 | .475 12,7 | 1.790 45,5 | 1.125 28,6 | .325 8,3 | .240 6,1 | 1.020 25,9 | .040 1,0 | 250 @ 100MHz      |  |
| FF28B1265 | .475 12,7 | 1.790 45,5 | 1.125 28,6 | .325 8,3 | .240 6,1 | 1.047 26,6 | .038 1,0 | 148 @ 100MHz      |  |
| FF28B1729 | .800 20,3 | 2.430 61,7 | 1.125 28,6 | .280 7,1 | .183 4,6 | 1.355 34,4 | .060 1,5 | 200 @ 100MHz      |  |
| FF28B2375 | .800 20,3 | 3.180 80,8 | 1.050 26,7 | .280 7,1 | .183 4,6 | 1.720 43,7 | .060 1,5 | 195 @ 100MHz      |  |
| FF28B2480 | .800 20,3 | 3.180 80,8 | 1.125 28,6 | .280 7,1 | .183 4,6 | 2.047 52,0 | .060 1,5 | 250 @ 100MHz      |  |
| FF28B3012 | .800 20,3 | 3.700 94,0 | 1.125 28,6 | .280 7,1 | .183 4,6 | 2.540 64,5 | .060 1,5 | 286 @ 100MHz      |  |

### flat cable clamp

**WITH DUAL PRESS FIT MOUNTS.** Ferrite assembly bonded in nylon mounting clamp; easily installed by pressing the integral spring tab fasteners into two .219" (5,6mm) diameter holes. Three sizes accommodate all flat cables up to 50-conductor width. Fits substrates up to .070" (1,8mm) thickness.

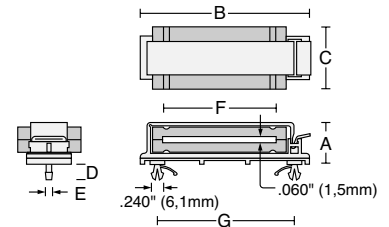

| PART No.  | A         | B          | C          | D        | E        | F          | G          | IMPEDANCE IN OHMS |  |
|-----------|-----------|------------|------------|----------|----------|------------|------------|-------------------|--|
| FD28B2375 | .800 20,3 | 3.180 80,8 | 1.050 26,7 | .280 7,1 | .183 4,6 | 1.720 43,7 | 2.550 64,8 | 195 @ 100MHz      |  |
| FD28B2480 | .800 20,3 | 3.180 80,8 | 1.125 28,6 | .280 7,1 | .183 4,6 | 2.047 52,0 | 2.550 64,8 | 250 @ 100MHz      |  |
| FD28B3012 | .800 20,3 | 3.700 94,0 | 1.125 28,6 | .280 7,1 | .183 4,6 | 2.540 64,5 | 2.550 64,8 | 286 @ 100MHz      |  |

### flat cable clamp

**WITH SPLIT END CAPS, HARDWARE MOUNT.** Ferrite assembly press-fitted into a pair of nylon end caps. Mounts using screws, push-rivets, or other hardware. Ten sizes accommodate flat cables up to 64-conductor width.

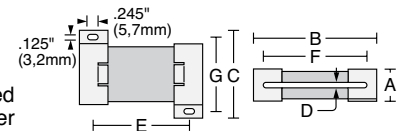

| PART No.  | A         | B           | C          | D        | E          | F          | G          | IMPEDANCE IN OHMS |  |
|-----------|-----------|-------------|------------|----------|------------|------------|------------|-------------------|--|
| SE28B0071 | .375 9,5  | .815 20,7   | 1.190 30,2 | .060 1,5 | .470 11,9  | .510 13,0  | .900 22,9  | 49 @ 100MHz       |  |
| SE28B0121 | .375 9,5  | 1.315 33,4  | 1.190 30,2 | .060 1,5 | 1.000 25,4 | 1.000 25,7 | .900 22,9  | 97 @ 100MHz       |  |
| SE28B0146 | .375 9,5  | 1.565 39,8  | 1.190 30,2 | .060 1,5 | 1.250 31,8 | 1.260 32,0 | .900 22,9  | 120 @ 100MHz      |  |
| SE28B0221 | .375 9,5  | 2.315 58,8  | 1.190 30,2 | .060 1,5 | 2.000 50,8 | 2.010 51,1 | .900 22,9  | 176 @ 100MHz      |  |
| SE28B1240 | .625 15,9 | 1.365 34,7  | 1.829 46,5 | .040 1,0 | .725 18,4  | 1.020 25,9 | 1.500 38,1 | 250 @ 100MHz      |  |
| SE28B1729 | .625 15,9 | 1.849 47,0  | 1.829 46,5 | .060 1,5 | 1.300 33,0 | 1.355 34,4 | 1.500 38,1 | 200 @ 100MHz      |  |
| SE28B2480 | .625 15,9 | 2.570 65,3  | 1.829 46,5 | .060 1,5 | 2.000 50,8 | 2.047 52,0 | 1.500 38,1 | 250 @ 100MHz      |  |
| SE28B3012 | .625 15,9 | 3.125 79,4  | 1.829 46,5 | .060 1,5 | 2.550 64,8 | 2.540 64,5 | 1.500 38,1 | 286 @ 100MHz      |  |
| SE28B3500 | .625 15,9 | 3.620 91,9  | 1.829 46,5 | .060 1,5 | 3.020 76,7 | 3.000 76,2 | 1.500 38,1 | 290 @ 100MHz      |  |
| SE28B4340 | .625 15,9 | 4.460 113,3 | 1.829 46,5 | .104 2,6 | 3.875 98,4 | 3.240 82,3 | 1.500 38,1 | 325 @ 100MHz      |  |

### flat cable clamp

**WITH SPLIT END CAPS, ADHESIVE MOUNT.** Ferrite assembly press-fitted into a pair of nylon end caps with adhesive foam mounting pads. Ten sizes accommodate flat cables up to 64-conductor width.

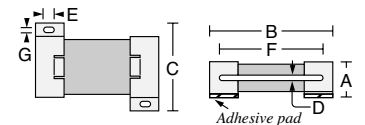

| PART No.  | A         | B           | C          | D        | E        | F          | G        | IMPEDANCE IN OHMS |  |
|-----------|-----------|-------------|------------|----------|----------|------------|----------|-------------------|--|
| SA28B0071 | .405 10,3 | .815 20,7   | 1.190 30,2 | .060 1,5 | .245 5,7 | .510 13,0  | .125 3,2 | 49 @ 100MHz       |  |
| SA28B0121 | .405 10,3 | 1.315 33,4  | 1.190 30,2 | .060 1,5 | .245 5,7 | 1.010 25,7 | .125 3,2 | 97 @ 100MHz       |  |
| SA28B0146 | .405 10,3 | 1.565 39,8  | 1.190 30,2 | .060 1,5 | .245 5,7 | 1.260 32,0 | .125 3,2 | 120 @ 100MHz      |  |
| SA28B0221 | .405 10,3 | 2.315 58,8  | 1.190 30,2 | .060 1,5 | .245 5,7 | 2.010 51,1 | .125 3,2 | 176 @ 100MHz      |  |
| SA28B1240 | .655 16,6 | 1.365 34,7  | 1.829 46,5 | .040 1,0 | .245 5,7 | 1.020 25,9 | .125 3,2 | 250 @ 100MHz      |  |
| SA28B1729 | .655 16,6 | 1.849 47,0  | 1.829 46,5 | .060 1,5 | .245 5,7 | 1.355 34,4 | .125 3,2 | 200 @ 100MHz      |  |
| SA28B2480 | .655 16,6 | 2.570 65,3  | 1.829 46,5 | .060 1,5 | .245 5,7 | 2.047 52,0 | .125 3,2 | 250 @ 100MHz      |  |
| SA28B3012 | .655 16,6 | 3.125 79,4  | 1.829 46,5 | .060 1,5 | .245 5,7 | 2.540 64,5 | .125 3,2 | 286 @ 100MHz      |  |
| SA28B3500 | .655 16,6 | 3.620 91,9  | 1.829 46,5 | .060 1,5 | .245 5,7 | 3.000 76,2 | .125 3,2 | 290 @ 100MHz      |  |
| SA28B4340 | .655 16,6 | 4.460 113,3 | 1.829 46,5 | .104 2,6 | .245 5,7 | 3.240 82,3 | .125 3,2 | 325 @ 100MHz      |  |

### high impedance flat cable clamp

**WITH ADHESIVE MOUNT.** Extra wide ferrite assembly greatly increases effective magnetic path. Bonded in nylon mounting clamp; easily installed by peeling protective paper strip from base and pressing into place. Three sizes accommodate all flat cables up to 50-conductor width.

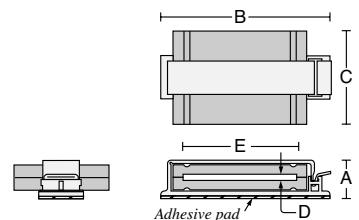

| PART No.  | w/o Adhesive | A         | B          | C          | D        | E          | IMPEDANCE IN OHMS |  |
|-----------|--------------|-----------|------------|------------|----------|------------|-------------------|--|
| FA28B1785 | FC28B1785    | .800 20,3 | 2.430 61,7 | 1.500 38,1 | .060 1,5 | 1.355 34,4 | 260 @ 100MHz      |  |
| FA28B2500 | FC28B2500    | .800 20,3 | 3.180 80,8 | 1.500 38,1 | .060 1,5 | 2.047 52,0 | 325 @ 100MHz      |  |
| FA28B3000 | FC28B3000    | .800 20,3 | 3.700 94,0 | 1.500 38,1 | .060 1,5 | 2.540 64,5 | 370 @ 100MHz      |  |

### high impedance flat cable clamp

**WITH SINGLE PRESS FIT MOUNT.** Extra wide ferrite assembly greatly increases effective magnetic path. Bonded in nylon mounting clamp; easily installed by pressing the integral spring tab fastener into a .250" (6,4mm) diameter hole. Three sizes accommodate all flat cables up to 50-conductor width. Fits substrates up to .070" (1,8mm) thickness.

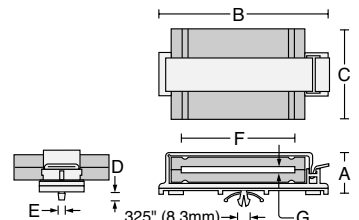

| PART No.  | A         | B          | C          | D        | E        | F          | G        | IMPEDANCE IN OHMS |  |
|-----------|-----------|------------|------------|----------|----------|------------|----------|-------------------|--|
| FF28B1785 | .800 20,3 | 2.430 61,7 | 1.500 38,1 | .280 7,1 | .183 4,6 | 1.355 34,4 | .060 1,5 | 260 @ 100MHz      |  |
| FF28B2500 | .800 20,3 | 3.180 80,8 | 1.500 38,1 | .280 7,1 | .183 4,6 | 2.047 52,0 | .060 1,5 | 325 @ 100MHz      |  |
| FF28B3000 | .800 20,3 | 3.700 94,0 | 1.500 38,1 | .280 7,1 | .183 4,6 | 2.540 64,5 | .060 1,5 | 370 @ 100MHz      |  |

### high impedance flat cable clamp

**WITH DUAL PRESS FIT MOUNTS.** Extra wide ferrite assembly greatly increases effective magnetic path. Bonded in nylon mounting clamp; easily installed by pressing the integral spring tab fasteners into two .219" (5,6mm) diameter holes. Two sizes accommodate all flat cables up to 50-conductor width. Fits substrates up to .070" (1,8mm) thickness.

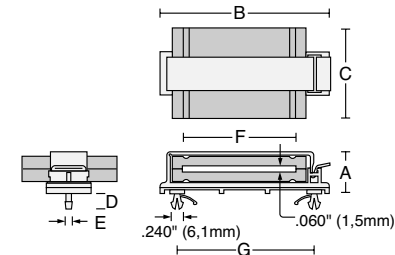

| PART No.  | A         | B          | C          | D        | E        | F          | G          | IMPEDANCE IN OHMS |  |
|-----------|-----------|------------|------------|----------|----------|------------|------------|-------------------|--|
| FD28B2500 | .800 20,3 | 3.180 80,8 | 1.500 38,1 | .280 7,1 | .183 4,6 | 2.047 52,0 | 2.550 64,8 | 325 @ 100MHz      |  |
| FD28B3000 | .800 20,3 | 3.700 94,0 | 1.500 38,1 | .280 7,1 | .183 4,6 | 2.540 64,5 | 2.550 64,8 | 370 @ 100MHz      |  |

### high impedance flat cable sleeve clamp

**WITH 15-CONDUCTOR FLAT CABLE OPENING.** Uniquely accommodates flat cables up to 15-conductors through the horizontal opening with substantially more impedance than standard flat clamps used typically for this type of application.

Available with optional adhesive foam mounting pad base.

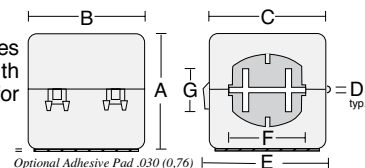

Available in standard colors gray (SS28B2035-15) and black (SS28B2035-15K) Patent No. 5,003,278

| PART No.     | w/ Adhesive Pad | A         | B         | C          | D        | E          | F         | IMPEDANCE IN OHMS |  |
|--------------|-----------------|-----------|-----------|------------|----------|------------|-----------|-------------------|--|
| SS28B2035-15 | AS28B2035-15    | 1.16 29,4 | 1.25 31,8 | 1.125 28,6 | .038 1,1 | 1.230 35,1 | .755 21,6 | 270 @ 100MHz      |  |



### low profile solids

**ULTRA-THIN.** Excellent for thin flex circuits and SCSI 2 flat cables on .025" (0,64mm) centers. Six sizes accommodate cable widths up to 2.00" (50,8 mm).

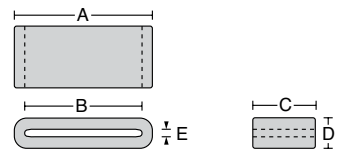

| PART No.  | A     |      | B     |      | C     |      | D    |     | E    |     | IMPEDANCE IN OHMS |
|-----------|-------|------|-------|------|-------|------|------|-----|------|-----|-------------------|
| 28R0760   | .760  | 19,3 | .510  | 13,0 | 1.125 | 28,6 | .300 | 7,6 | .051 | 1,3 | 150 @ 100MHz      |
| 28R1127   | 1.125 | 28,6 | .925  | 23,5 | 1.220 | 31,0 | .303 | 7,7 | .066 | 1,7 | 188 @ 100MHz      |
| 28R1127-2 | 1.125 | 28,6 | .925  | 23,5 | .980  | 24,9 | .303 | 7,7 | .066 | 1,7 | 151 @ 100MHz      |
| 28R1260   | 1.260 | 32,0 | 1.010 | 25,7 | 1.125 | 28,6 | .300 | 7,6 | .051 | 1,3 | 237 @ 100MHz      |
| 28R1575   | 1.575 | 40,0 | 1.325 | 33,7 | 1.125 | 28,6 | .300 | 7,6 | .051 | 1,3 | 160 @ 100MHz      |
| 28R1953   | 1.953 | 49,6 | 1.732 | 44,0 | .472  | 12,0 | .288 | 7,3 | .059 | 1,5 | 109 @ 100MHz      |
| 28R2300   | 2.300 | 58,4 | 2.050 | 52,1 | 1.125 | 28,6 | .300 | 7,6 | .051 | 1,3 | 245 @ 100MHz      |



### low profile solids

**ULTRA-THIN WITH SHOCK MOUNT ADHESIVE FOAM BASE.** Excellent for thin flex circuits and SCSI 2 flat cables on .025" (0,64mm) centers. Six sizes accommodate cable widths up to 2.00" (50,8mm). High tack adhesive mounting pad secures to almost any surface. Can be stacked one on top of another.

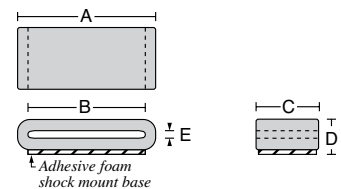

| PART No.    | A     |      | B     |      | C     |      | D    |     | E    |     | IMPEDANCE IN OHMS |
|-------------|-------|------|-------|------|-------|------|------|-----|------|-----|-------------------|
| SM28R0760   | .760  | 19,3 | .510  | 13,0 | 1.125 | 28,6 | .330 | 8,4 | .051 | 1,3 | 150 @ 100MHz      |
| SM28R1127   | 1.125 | 28,6 | .925  | 23,5 | 1.220 | 31,0 | .333 | 8,5 | .066 | 1,7 | 188 @ 100MHz      |
| SM28R1127-2 | 1.125 | 28,6 | .925  | 23,5 | .980  | 24,9 | .303 | 8,5 | .066 | 1,7 | 151 @ 100MHz      |
| SM28R1260   | 1.260 | 32,0 | 1.010 | 25,7 | 1.125 | 28,6 | .330 | 8,4 | .051 | 1,3 | 237 @ 100MHz      |
| SM28R1575   | 1.575 | 40,0 | 1.325 | 33,7 | 1.125 | 28,6 | .330 | 8,4 | .051 | 1,3 | 160 @ 100MHz      |
| SM28R1953   | 1.953 | 49,6 | 1.732 | 44,0 | .472  | 12,0 | .318 | 8,1 | .059 | 1,5 | 109 @ 100MHz      |
| SM28R2300   | 2.300 | 58,4 | 2.050 | 52,1 | 1.125 | 28,6 | .330 | 8,4 | .051 | 1,3 | 245 @ 100MHz      |

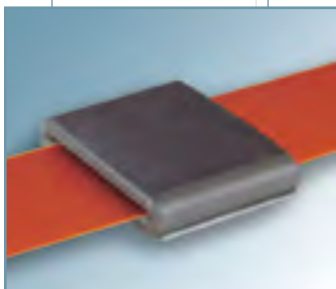

### flex-circuit low profile solids

**ULTRA-THIN WITH OPTIONAL ADHESIVE FOAM BASE.** Solid thin profile ferrite suppressors. Excellent for flex-circuits and tight spaces. Various sizes can accommodate circuits up to 1.25" (31,8mm).

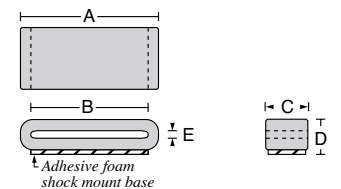

| PART No.    | w/Adhesive   | A     |      | B     |      | C    |      | D    |     | E    |     | IMPEDANCE IN OHMS |
|-------------|--------------|-------|------|-------|------|------|------|------|-----|------|-----|-------------------|
| FX28R0984-0 | FX28R0984-0A | .984  | 25,0 | .709  | 18,0 | .945 | 24,0 | .303 | 7,7 | .035 | 0,9 | 220 @ 100MHz      |
| FX28R0984-2 | FX28R0984-2A | .984  | 25,0 | .709  | 18,0 | .630 | 16,0 | .303 | 7,7 | .035 | 0,9 | 170 @ 100MHz      |
| FX28R1261-2 | FX28R1261-2A | 1.260 | 32,0 | .988  | 25,1 | .382 | 9,7  | .303 | 7,7 | .035 | 0,9 | 135 @ 100MHz      |
| FX28R1450-1 | FX28R1450-1A | 1.450 | 36,8 | 1.165 | 29,6 | .394 | 10,0 | .303 | 7,7 | .035 | 0,9 | 130 @ 100MHz      |
| FX28R1457-4 | FX28R1457-4A | 1.457 | 37,0 | 1.299 | 33,0 | .530 | 13,5 | .177 | 4,5 | .020 | 0,5 | 140 @ 100MHz      |



### rectangular solids

**WITH OPTIONAL SHOCK-MOUNT ADHESIVE FOAM BASE.** Solid ferrite suppressors configured to accept flat ribbon cables. Must be installed prior to termination of the cable. High tack adhesive mounting pad secures the cable routing to a fixed point on almost any surface. Can be stacked one on top of another. A variety of designs accommodate special installation and insertion loss requirements.

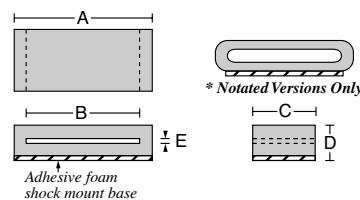

| PART No.  | w/Adhesive  | A     |      | B     |      | C     |      | D     |      | E    |      | IMPEDANCE IN OHMS |
|-----------|-------------|-------|------|-------|------|-------|------|-------|------|------|------|-------------------|
| 28B0785   | SM28B0785   | .785  | 19,9 | .515  | 13,1 | 1.100 | 27,9 | .445  | 11,3 | .145 | 3,7  | 170 @ 100MHz      |
| 28R1531*  | SM28R1531*  | 1.530 | 38,9 | 1.045 | 26,5 | 1.125 | 28,6 | 1.055 | 26,8 | .510 | 13,0 | 196 @ 100MHz      |
| 28B1775   | SM28B1775   | 1.775 | 45,1 | 1.355 | 34,4 | 1.125 | 28,6 | .520  | 13,2 | .060 | 1,52 | 293 @ 100MHz      |
| 28B1779   | SM28B1779   | 2.500 | 63,5 | 2.050 | 52,1 | 1.125 | 28,6 | .530  | 13,5 | .066 | 1,68 | 295 @ 100MHz      |
| 28B1101   | SM28B1101   | 1.101 | 28,0 | .902  | 22,9 | .577  | 14,7 | .335  | 8,5  | .059 | 1,5  | 133 @ 100MHz      |
| 28B1775-1 | SM28B1775-1 | 1.775 | 45,1 | 1.355 | 34,4 | .500  | 12,7 | .520  | 13,2 | .060 | 1,5  | 151 @ 100MHz      |
| 28B2170-1 | SM28B2170-1 | 2.170 | 55,1 | 1.720 | 43,7 | .500  | 12,7 | .530  | 13,5 | .050 | 1,3  | 176 @ 100MHz      |
| 28B2002   | SM28B2002   | 2.394 | 60,8 | 2.000 | 50,8 | .610  | 15,5 | .724  | 18,4 | .300 | 7,6  | 109 @ 100MHz      |
| 28B3149   | SM28B3149   | 3.149 | 80,0 | 2.700 | 68,6 | .500  | 12,7 | .502  | 12,8 | .075 | 1,9  | 93 @ 100MHz       |

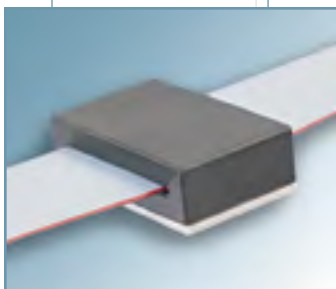

saddle beads®



HALF-TOROIDS AND HALF-BEADS WITH OR WITHOUT ADHESIVE MOUNT BASE.

Absorbs RFI right at the source before resonance and harmonics effects are transferred to neighboring components.

U-shaped with central opening extending directly to the outside radius for easy mounting. By simply straddling a cable or PCB component, a significant amount of magnetic coupling occurs, between 30%-40% of the impedance of our fully circumferential styles, depending on configuration.

Excellent for quick, economical applications, tight spaces, electronic enclosure cable routing, and especially direct mounting over leaded or surface mount printed circuit components. Attaches to any surface with optional adhesive foam base or common electronic adhesives.

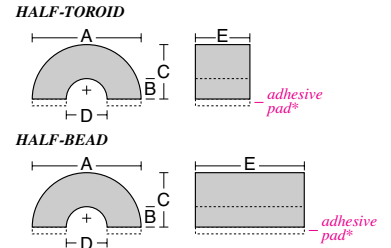

\* Optional adhesive mount base .030" (0,7mm) thick  
+ Point of measured impedance (see impedance below)

| PART No. without Adhesive Mount | PART No. with Adhesive Mount | A     | B    | C    | D    | E     | TYPE | IMPEDANCE IN OHMS (ref.) |      |       |      |             |              |
|---------------------------------|------------------------------|-------|------|------|------|-------|------|--------------------------|------|-------|------|-------------|--------------|
| SB28B0550                       | SB28B0550AB                  | .550  | 14,0 | .107 | 2,7  | .275  | 7,0  | .214                     | 5,4  | 1.105 | 28,0 | half bead   | 100 @ 100MHz |
| SB28B0617                       | SB28B0617AB                  | .617  | 15,7 | .138 | 3,5  | .308  | 7,8  | .276                     | 7,0  | 1.125 | 28,6 | half toroid | 95 @ 100MHz  |
| SB28B0642                       | SB28B0642AB                  | .642  | 16,3 | .150 | 3,8  | .341  | 8,7  | .320                     | 8,1  | .630  | 16,0 | half toroid | 30 @ 100MHz  |
| SB28B0805                       | SB28B0805AB                  | .805  | 20,4 | .172 | 4,3  | .402  | 10,2 | .404                     | 10,3 | .394  | 10,0 | half toroid | 25 @ 100MHz  |
| SB28B0937                       | SB28B0937AB                  | .937  | 23,8 | .224 | 5,7  | .468  | 11,9 | .449                     | 11,4 | .551  | 14,0 | half toroid | 34 @ 100MHz  |
| SB28B1123                       | SB28B1123AB                  | 1.123 | 28,5 | .271 | 6,9  | .561  | 14,2 | .543                     | 13,8 | 1.125 | 28,6 | half toroid | 83 @ 100MHz  |
| SB28B0984                       | SB28B0984AB                  | .984  | 25,0 | .295 | 7,5  | .492  | 12,5 | .591                     | 15,0 | .472  | 12,0 | half toroid | 37 @ 100MHz  |
| SB28B1251                       | SB28B1251AB                  | 1.251 | 31,8 | .375 | 9,5  | .625  | 15,9 | .750                     | 19,1 | .875  | 22,2 | half toroid | 50 @ 100MHz  |
| SB28B1501                       | SB28B1501AB                  | 1.500 | 38,1 | .375 | 9,5  | .750  | 19,1 | .750                     | 19,1 | 1.000 | 25,4 | half toroid | 80 @ 100MHz  |
| SB28B1500                       | SB28B1500AB                  | 1.500 | 38,1 | .500 | 12,7 | .750  | 19,1 | 1.000                    | 25,4 | 1.000 | 25,4 | half toroid | 75 @ 100MHz  |
| SB28B2000                       | SB28B2000AB                  | 2.000 | 50,0 | .500 | 12,7 | 1.000 | 25,4 | 1.000                    | 25,4 | 1.500 | 38,1 | half toroid | 175 @ 100MHz |

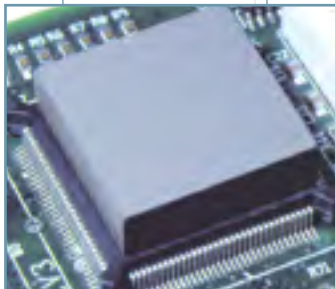

saddle beads®

HALF-SLEEVES AND RECTANGULAR PLATES WITH OR WITHOUT ADHESIVE MOUNT BASE.

Absorbs RFI right at the source before resonance and harmonics effects are transferred to neighboring components.

Rectangular sleeves or plate shapes with central opening extending outward to easily straddle a cable or PCB component, introducing a significant amount of magnetic coupling and impedance. Between 30% to 40% of the impedance of our fully enclosed styles, depending on configuration.

When affixed with thermally conductive adhesive to flat components, such as semiconductors, heat sink thermal dissipation occurs, increasing component efficiency. Attaches to any surface with optional adhesive foam base or common electronic adhesives.

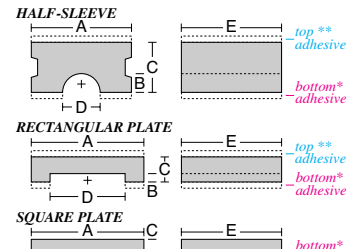

\* Optional adhesive bottom mount base .030" (0,7mm)  
\*\* Optional adhesive top mount base .030" (0,7mm)  
+ Point of measured impedance (see impedance below)

| PART No. without Adhesive Mount | PART No. with top** Adhesive Mount | PART No. with bottom* Adhesive Mount | A     | B     | C    | D   | E    | TYPE | IMPEDANCE IN OHMS (ref.) |       |       |              |                   |              |
|---------------------------------|------------------------------------|--------------------------------------|-------|-------|------|-----|------|------|--------------------------|-------|-------|--------------|-------------------|--------------|
| SB28B2027                       | SB28B2027AT                        | SB28B2027AB                          | .296  | 7,5   | .048 | 1,2 | .148 | 3,8  | .096                     | 2,4   | .297  | 7,5          | half sleeve       | 18 @ 100MHz  |
| SB28B2034                       | SB28B2034AT                        | SB28B2034AB                          | .445  | 11,3  | .110 | 2,8 | .200 | 5,1  | .220                     | 5,6   | 1.000 | 25,4         | half sleeve       | 30 @ 100MHz  |
| SB28B2031                       | SB28B2031AT                        | SB28B2031AB                          | .536  | 13,6  | .125 | 3,2 | .270 | 6,9  | .250                     | 6,4   | 1.100 | 27,9         | half sleeve       | 45 @ 100MHz  |
| SB28B2030                       | SB28B2030AT                        | SB28B2030AB                          | .638  | 16,2  | .176 | 4,5 | .319 | 8,1  | .352                     | 9,0   | 1.100 | 27,9         | half sleeve       | 40 @ 100MHz  |
| SB28B2041                       | SB28B2041AT                        | SB28B2041AB                          | .800  | 20,3  | .200 | 5,1 | .400 | 10,2 | .400                     | 10,2  | 1.100 | 27,9         | half sleeve       | 40 @ 100MHz  |
| SB28B2032                       | SB28B2032AT                        | SB28B2032AB                          | .965  | 24,5  | .256 | 6,5 | .492 | 12,5 | .512                     | 13,0  | 1.050 | 26,7         | half sleeve       | 60 @ 100MHz  |
| SB28B2035                       | SB28B2035AT                        | SB28B2035AB                          | .965  | 24,5  | .365 | 9,3 | .492 | 12,5 | .730                     | 18,5  | 1.050 | 26,7         | half sleeve       | 65 @ 100MHz  |
| SB28B2039                       | SB28B2039AT                        | SB28B2039AB                          | 1.400 | 35,5  | .255 | 6,5 | .700 | 17,8 | .510                     | 13,0  | 1.500 | 38,1         | half sleeve       | 245 @ 100MHz |
| SB28B2043                       | SB28B2043AT                        | SB28B2043AB                          | 1.400 | 35,5  | .375 | 9,5 | .700 | 17,8 | .750                     | 17,8  | 1.500 | 38,1         | half sleeve       | 125 @ 100MHz |
| SB28B0010                       | SB28B0010AT                        | SB28B0010AB                          | .325  | 8,3   | .062 | 1,6 | .163 | 4,1  | .125                     | 3,2   | .600  | 15,2         | half sleeve       | 20 @ 100MHz  |
| SB28B0071                       | SB28B0071AT                        | SB28B0071AB                          | .710  | 18,0  | .030 | 0,7 | .130 | 3,3  | .510                     | 13,0  | .500  | 12,7         | rectangular plate | 23 @ 100MHz  |
| SB28B0121                       | SB28B0121AT                        | SB28B0121AB                          | 1.210 | 30,7  | .030 | 0,7 | .130 | 3,3  | 1.010                    | 25,7  | .500  | 12,7         | rectangular plate | 35 @ 100MHz  |
| SB28B0146                       | SB28B0146AT                        | SB28B0146AB                          | 1.460 | 37,1  | .030 | 0,7 | .130 | 3,3  | 1.260                    | 32,0  | .500  | 12,7         | rectangular plate | 30 @ 100MHz  |
| SB28B0221                       | SB28B0221AT                        | SB28B0221AB                          | 2.210 | 56,1  | .030 | 0,7 | .130 | 3,3  | 2.010                    | 51,1  | .500  | 12,7         | rectangular plate | 30 @ 100MHz  |
| SB28B1729                       | SB28B1729AT                        | SB28B1729AB                          | 1.729 | 43,9  | .030 | 0,7 | .250 | 6,4  | 1.355                    | 34,4  | 1.125 | 28,6         | rectangular plate | 80 @ 100MHz  |
| SB28B2375                       | SB28B2375AT                        | SB28B2375AB                          | 2.350 | 59,7  | .030 | 0,7 | .250 | 6,4  | 1.720                    | 43,7  | 1.000 | 25,4         | rectangular plate | 79 @ 100MHz  |
| SB28B2480                       | SB28B2480AT                        | SB28B2480AB                          | 2.500 | 63,5  | .030 | 0,7 | .250 | 6,4  | 2.047                    | 52,0  | 1.125 | 28,6         | rectangular plate | 100 @ 100MHz |
| SB28B3012                       | SB28B3012AT                        | SB28B3012AB                          | 3.000 | 76,2  | .030 | 0,7 | .250 | 6,4  | 2.540                    | 64,5  | 1.125 | 28,6         | rectangular plate | 105 @ 100MHz |
| SB28B3500                       | SB28B3500AT                        | SB28B3500AB                          | 3.500 | 86,5  | .030 | 0,7 | .250 | 6,4  | 3.000                    | 76,2  | 1.125 | 28,6         | rectangular plate | 125 @ 100MHz |
| SB28B4340                       | SB28B4340AT                        | SB28B4340AB                          | 4.340 | 110,2 | .052 | 1,3 | .250 | 6,4  | 3.240                    | 82,3  | 1.125 | 28,6         | rectangular plate | 150 @ 100MHz |
| SB28B0500                       | N/A                                | SB28B0500AB                          | .500  | 12,7  | N/A  | N/A | .250 | 6,4* | N/A                      | .500  | 12,7  | square plate | 25 @ 100MHz       |              |
| SB28B0500-1                     | N/A                                | SB28B0500-1AB                        | .500  | 12,7  | N/A  | N/A | .100 | 2,5  | N/A                      | .500  | 12,7  | square plate | 10 @ 100MHz       |              |
| SB28B0875                       | N/A                                | SB28B0875AB                          | .875  | 22,2  | N/A  | N/A | .250 | 6,4* | N/A                      | .875  | 22,2  | square plate | 40 @ 100MHz       |              |
| SB28B0875-1                     | N/A                                | SB28B0875-1AB                        | .875  | 22,2  | N/A  | N/A | .100 | 2,5  | N/A                      | .875  | 22,2  | square plate | 24 @ 100MHz       |              |
| SB28B1055                       | N/A                                | SB28B1055AB                          | 1.055 | 26,8  | N/A  | N/A | .250 | 6,4* | N/A                      | 1.055 | 26,8  | square plate | 65 @ 100MHz       |              |
| SB28B1055-1                     | N/A                                | SB28B1055-1AB                        | 1.055 | 26,8  | N/A  | N/A | .100 | 2,5  | N/A                      | 1.055 | 26,8  | square plate | 28 @ 100MHz       |              |
| SB28B2100                       | N/A                                | SB28B2100AB                          | 2.100 | 53,3  | N/A  | N/A | .250 | 6,4* | N/A                      | 2.100 | 53,3  | square plate | 130 @ 100MHz      |              |
| SB28B2100-1                     | N/A                                | SB28B2100-1AB                        | 2.100 | 53,3  | N/A  | N/A | .100 | 2,5  | N/A                      | 2.100 | 53,3  | square plate | 70 @ 100MHz       |              |

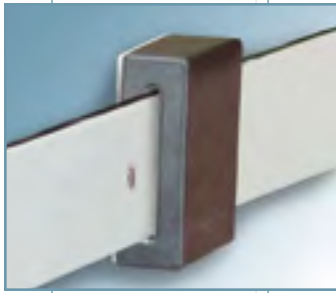

## rectangular solid bus bar ferrite

**EXTRA WIDE OPENING WITH OPTIONAL ADHESIVE MOUNTING.** Excellent for bus bar thicknesses up to .500" (12,7mm). Three sizes accommodate bus bar widths up to 2.000" (50,8mm). Optional high tack adhesive mounting secures to almost any surface. Can be stacked one upon the other.

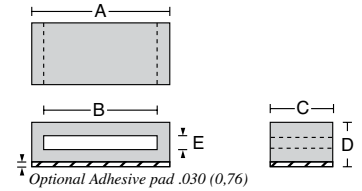

| PART No. | w/ adhesive | A          | B          | C          | D          | E         | IMPEDANCE IN OHMS |  |
|----------|-------------|------------|------------|------------|------------|-----------|-------------------|--|
| 28B0785  | SM28B0785   | .785 19,9  | .515 13,1  | 1.100 27,9 | .415 10,5  | .145 3,7  | 170 @ 100MHz      |  |
| 28R1531  | SM28R1531   | 1.530 38,9 | 1.045 26,5 | 1.125 28,6 | 1.025 26,0 | .510 13,0 | 196 @ 100MHz      |  |
| 28B2002  | SM28B2002   | 2.394 60,8 | 2.000 50,8 | .610 15,5  | .694 17,6  | .300 7,6  | 109 @ 100MHz      |  |



## rectangular split ferrite bus bar clamp

**EXTRA WIDE OPENING WITH ADHESIVE FOAM MOUNTING BASE.** All-purpose series of two sizes accommodate all bus bar widths up to 2.45" (62,2mm) and thicknesses up to .285" (6,5mm). Installs easily by peeling protective paper liner from base.

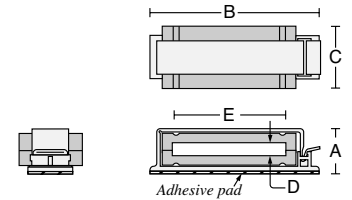

| PART No.  | A          | B          | C          | D        | E          | IMPEDANCE IN OHMS |  |
|-----------|------------|------------|------------|----------|------------|-------------------|--|
| FA28B2940 | 1.040 26,4 | 3.700 94,0 | 1.125 28,6 | .290 7,3 | 2.500 63,5 | 160 @ 100MHz      |  |



## rectangular split ferrite bus bar clamp

**EXTRA WIDE OPENING WITH PRESS-FIT MOUNTING BASE.** For bus bar widths up to 2.45" (62,2mm) and thicknesses up to .285" (6,5mm). Installs easily by pressing the integral spring tab fastener into a .250" (6,4mm) diameter hole. Accommodates panel thicknesses up to .150" (3,81mm).

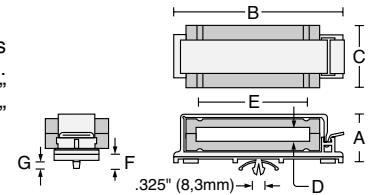

| PART No.  | A          | B          | C          | D        | E          | F        | G        | IMPEDANCE IN OHMS |  |
|-----------|------------|------------|------------|----------|------------|----------|----------|-------------------|--|
| FF28B2440 | 1.040 26,4 | 3.180 80,8 | 1.125 28,6 | .290 7,3 | 2.000 50,8 | .390 9,9 | .200 5,1 | 180 @ 100MHz      |  |
| FF28B2940 | 1.040 26,4 | 3.700 94,0 | 1.125 28,6 | .290 7,3 | 2.500 63,5 | .390 9,9 | .200 5,1 | 160 @ 100MHz      |  |



## special purpose shielding bar

For situations where extremely high amounts of attenuation are needed. Can be strapped longitudinally onto bus bars with common cable tie-wraps; or, potting compounds can be used. Sandwiching the bus bar between two shielding bars will dramatically increase impedance up to three times the effect of a single bar depending on frequencies involved. Optional adhesive pad facilitates mounting.

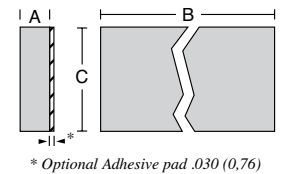

| PART No.  | w/ adhesive | A        | B           | C         | IMPEDANCE IN OHMS      |  |
|-----------|-------------|----------|-------------|-----------|------------------------|--|
| SB28B5630 | SB28B5630A  | .365 9,3 | 5.630 143,0 | 1.00 25,4 | one pass: 500 @ 100MHz |  |



## universal-fit clamps and sleeves

**STANDARD CATALOG CABLE FERRITE ASSEMBLIES.** Any of the round or flat cable clamps shown elsewhere in this catalog make a perfectly good solution for many bus bar geometries and their mounting requirements. A properly placed suppressor will attenuate unwanted high frequency signals, thus negating the conductor and/or antenna-like radiating effects at specific frequencies while not disturbing the power distribution characteristics.



## cable snap



Ferrite assembly in fully enclosed nylon case; functional with wires and cables up to a 2.0" (50,8mm) diameter. Snap closed around wire by clasping shut to position assembly.

May also be mounted with a flat-head screw through the .120" (3,0mm) diameter hole in the bottom by temporarily removing lower ferrite half.

Very effective from 1 MHz to 60 MHz; peak attenuation at 30 MHz. See pages 32 and 33 for impedance curve characteristics.

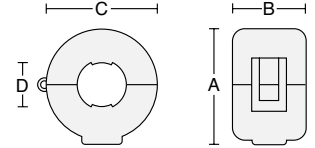

| PART No.  | A           | B          | C           | D          | IMPEDANCE IN OHMS                           |
|-----------|-------------|------------|-------------|------------|---|
| CS33B1805 | 1.040 26,4  | .667 16,9  | 1.025 26,4  | .340 8,6   | 22 @ 30MHz                                  |
| CS33B1984 | 1.218 30,9  | .705 17,9  | 1.220 31,0  | .525 13,3  | 20 @ 30MHz                                  |
| CS33B2000 | 2.350 59,7  | 1.851 47,0 | 2.309 58,6  | .960 24,4  | see page 31 for more details<br>210 @ 30MHz |
| CS33B4000 | 4.500 114,2 | 1.851 47,0 | 4.687 110,0 | 1.960 49,8 | see page 31 for more details<br>140 @ 30MHz |

## sleeve snap



Box-shaped ferrite assembly in enclosed nylon case. Various sizes are functional with wires up to .500" (12,7mm) diameter. Simply clamp around cable or wire; plastic tabs at entry/exit ports apply pressure to cable surface to maintain mounting position. Options include foam adhesive pad on bottom.

Very effective from 1 MHz to 60 MHz; peak attenuation at 30 MHz. See pages 32 and 33 for impedance curve characteristics.

Available in standard colors gray (i.e., SS33B2030) and black (i.e., SS33B2030K)

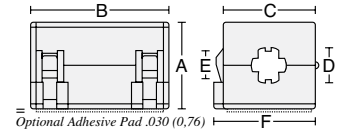

| PART No.            | w/ Adhesive | A          | B          | C          | D         | E         | F          | IMPEDANCE IN OHMS |
|---------------------|-------------|------------|------------|------------|-----------|-----------|------------|-------------------|
| SS33B2030 AS33B2030 |             | .790 20,1  | 1.265 32,1 | .770 19,6  | .270 6,9  | .220 5,6  | .885 22,5  | 23 @ 30MHz        |
| SS33B2033 AS33B2033 |             | .790 20,1  | 1.265 32,1 | .770 19,6  | .350 8,8  | .290 7,4  | .885 22,5  | 23 @ 30MHz        |
| SS33B2036 AS33B2036 |             | 1.155 29,3 | 1.250 31,8 | 1.125 28,6 | .415 10,5 | .350 8,9  | 1.230 31,2 | 27 @ 30MHz        |
| SS33B2040 AS33B2040 |             | 1.155 29,3 | 1.250 31,8 | 1.125 28,6 | .550 14,0 | .480 12,2 | 1.230 31,2 | 27 @ 30MHz        |

Patent No. 5,764,125

## sleeve snap

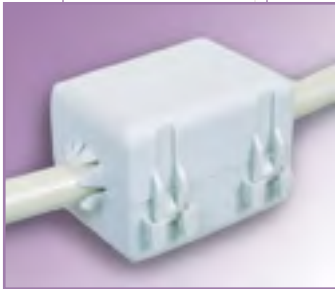

**WITH VARIABLE DIAMETER END PORTS.** Box-shaped ferrite assembly in fully enclosed nylon case. End ports are surrounded with flexible spring flutes to grip a range of cable diameters from .125" to .500" (3,2 to 12,7 mm). Special mounting options include foam adhesive pad on bottom.

Very effective from 1 MHz to 60 MHz; peak attenuation at 30 MHz. See pages 32 and 33 for impedance curve characteristics.

Available in standard colors gray (i.e., SS33B2037) and black (i.e., SS33B2037K)

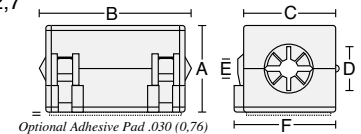

| PART No.            | w/ Adhesive | A          | B (ref.)   | C          | D         | E        | F          | IMPEDANCE IN OHMS |
|---------------------|-------------|------------|------------|------------|-----------|----------|------------|-------------------|
| SS33B2037 AS33B2037 |             | .790 20,1  | 1.450 36,8 | .770 19,6  | .350 8,8  | .200 5,1 | .885 22,5  | 23 @ 30 MHz       |
| SS33B2032 AS33B2032 |             | 1.155 29,3 | 1.450 36,8 | 1.125 28,6 | .500 12,7 | .200 5,1 | 1.230 31,2 | 27 @ 30 MHz       |

Patent No. 5,003,278 and Patent No. 5,764,125

## sleeve snap for cable bundles



Box-shaped ferrite assembly for cable bundle diameters up to .730" (18,5mm) diameter. Allows single location for RFI suppression for multiple cables. Each circuit reacts separately with the suppression material without saturation. Alternatively, multiple turns of a single cable greatly increases impedance depending on frequency - see page 6, figures 3 and 4. Optional adhesive mount base.

Very effective from 1 MHz to 60 MHz; peak attenuation at 30 MHz. See pages 32 and 33 for impedance curve characteristics.

Available in standard colors gray (i.e., SS33B2035) and black (i.e., SS33B2035K)

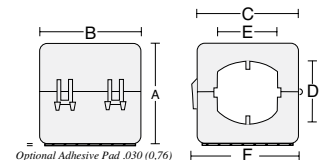

| PART No.            | w/ Adhesive | A          | B          | C          | D         | E         | F          | IMPEDANCE IN OHMS |
|---------------------|-------------|------------|------------|------------|-----------|-----------|------------|-------------------|
| SS33B2035 AS33B2035 |             | 1.155 29,3 | 1.250 31,8 | 1.125 28,6 | .790 20,1 | .720 18,3 | 1.230 31,2 | 23 @ 30MHz        |

## cable clamp



Ferrite assembly bonded to nylon strap; functional with wires and cables up to a 1.00" (25,4 mm) diameter. Holes are provided for screw mounting.

Very effective from 1 MHz to 60 MHz; peak attenuation at 30 MHz. See pages 32 and 33 for impedance curve characteristics.

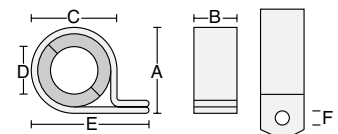

| PART No.  | A          | B          | C          | D          | E          | F        | IMPEDANCE IN OHMS |
|-----------|------------|------------|------------|------------|------------|----------|-------------------|
| TC33B0805 | .948 24,1  | .500 12,7  | .948 24,1  | .404 10,3  | 1.498 38,0 | .195 5,0 | 22 @ 30MHz        |
| TC33B0984 | 1.127 28,6 | .500 12,7  | 1.127 28,6 | .591 15,0  | 1.677 42,6 | .195 5,0 | 20 @ 30MHz        |
| TC33B2000 | 2.125 54,0 | 1.500 38,1 | 2.125 54,0 | 1.000 25,4 | 2.860 72,6 | .281 7,1 | 210 @ 30MHz       |

## flat cable clamp



**WITH FULL OUTER ENCLOSURE AND ADHESIVE MOUNT.** Ferrite assembly in fully enclosed nylon case for flat cables up to 64-conductor width. Internal grip-lock tabs apply pressure on cable to maintain mounting position. Very effective from 1 MHz to 60 MHz with a peak attenuation at 30 MHz. For typical impedance curve comparisons to other material formulations, see page 33; and for specific impedance curves see page 32, bottom.

Installs easily on any mounting surface by removing liner from foam adhesive base pad. Also available without the adhesive mounting pad for assembly with two flat head screws through the .120" (3,0 mm) diameter holes on 1.25" (31,8 mm) centers in the bottom by temporarily removing the lower ferrite half.

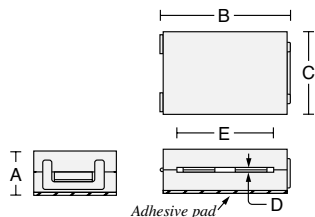

| PART No.  | w/o Adhesive | A    | B    | C    | D     | E     | IMPEDANCE IN OHMS |          |            |             |
|-----------|--------------|------|------|------|-------|-------|-------------------|----------|------------|-------------|
| RA33B2480 | RC33B2480    | .700 | 17,8 | 2,76 | 70,1  | 1.312 | 33,3              | .060 1,5 | 2.047 52,0 | 31 @ 30 MHz |
| RA33B4340 | RC33B4340    | .785 | 19,9 | 4,61 | 117,1 | 1.312 | 33,3              | .104 2,6 | 3.240 82,3 | 79 @ 30 MHz |

## flat cable clamp

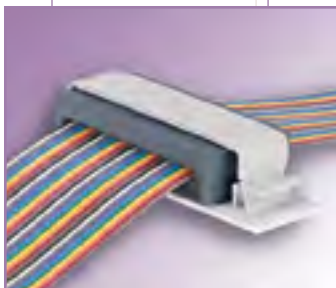

**WITH ADHESIVE MOUNT.** Ferrite assembly bonded in nylon mounting clamp; easily installed by peeling protective paper strip from base and pressing into place. One size accommodates all flat cables up to 40-conductor width.

Very effective from 1 MHz to 60 MHz with a peak attenuation at 30 MHz.

For typical impedance curve comparisons to other material formulations, see page 33; and for specific impedance curves see page 32, bottom

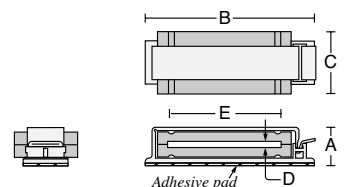

| PART No.  | w/o Adhesive | A    | B    | C     | D    | E     | IMPEDANCE IN OHMS |          |            |             |
|-----------|--------------|------|------|-------|------|-------|-------------------|----------|------------|-------------|
| FA33B2480 | FC33B2480    | .800 | 20,3 | 3.180 | 80,8 | 1.125 | 28,6              | .060 1,5 | 2.047 52,0 | 31 @ 30 MHz |

## flat cable clamp

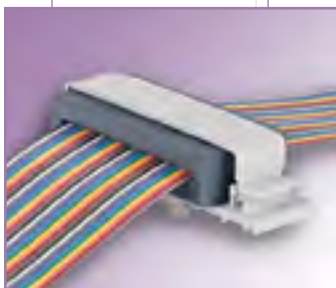

**WITH SINGLE PRESS FIT MOUNT.** Ferrite assembly bonded in nylon mounting clamp; easily installed by pressing the integral spring tab fastener into a .250" (6,4mm) diameter hole. One size accommodates all flat cables up to 40-conductor width. Fits substrates up to .070" (1,8mm) thickness.

Very effective from 1 MHz to 60 MHz with a peak attenuation at 30 MHz.

For typical impedance curve comparisons to other material formulations, see page 33; and for specific impedance curves see page 32, bottom

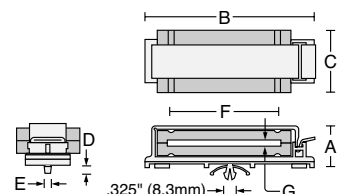

| PART No.  | A    | B    | C     | D    | E     | F    | G    | IMPEDANCE IN OHMS |          |            |          |            |
|-----------|------|------|-------|------|-------|------|------|-------------------|----------|------------|----------|------------|
| FF33B2480 | .800 | 20,3 | 3.180 | 80,8 | 1.125 | 28,6 | .280 | 7,1               | .183 4,6 | 2.047 52,0 | .060 1,5 | 31 @ 30MHz |

## flat cable clamp



**WITH DUAL PRESS FIT MOUNTS.** Ferrite assembly bonded in nylon mounting clamp; easily installed by pressing the integral spring tab fasteners into two .219" (5,6mm) diameter holes. One size accommodates all flat cables up to 40-conductor width. Fits substrates up to .070" (1,8mm) thickness.

Very effective from 1 MHz to 60 MHz with a peak attenuation at 30 MHz.

For typical impedance curve comparisons to other material formulations, page 33; and for specific impedance curves see page 32, bottom

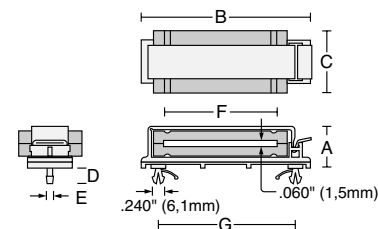

| PART No.  | A    | B    | C     | D    | E     | F    | G    | IMPEDANCE IN OHMS |          |            |            |            |
|-----------|------|------|-------|------|-------|------|------|-------------------|----------|------------|------------|------------|
| FD33B2480 | .800 | 20,3 | 3.180 | 80,8 | 1.125 | 28,6 | .280 | 7,1               | .183 4,6 | 2.047 52,0 | 2.550 64,8 | 31 @ 30MHz |

## flat cable clamp



**WITH SPLIT END CAPS, ADHESIVE MOUNT.** Ferrite assembly press-fitted into a pair of nylon end caps with adhesive foam mounting pads. Two sizes accommodate flat cables up to 64-conductor width.

Very effective from 1 MHz to 60 MHz with a peak attenuation at 30 MHz.

For typical impedance curve comparisons to other material formulations, see page 33; and for specific impedance curves see page 32, bottom

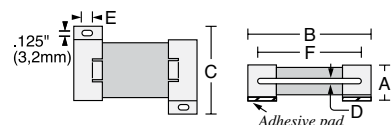

| PART No.  | w/o Adhesive | A    | B    | C     | D     | E     | F    | IMPEDANCE IN OHMS |          |            |             |
|-----------|--------------|------|------|-------|-------|-------|------|-------------------|----------|------------|-------------|
| SA33B2480 | SE33B2480    | .655 | 16,6 | 2.570 | 65,3  | 1.829 | 46,5 | .060 1,5          | .245 5,7 | 2.047 52,0 | 31 @ 30 MHz |
| SA33B4340 | SE33B4340    | .655 | 16,6 | 4.460 | 113,3 | 1.829 | 46,5 | .104 2,6          | .245 5,7 | 3.240 82,3 | 79 @ 30 MHz |



## cable snap

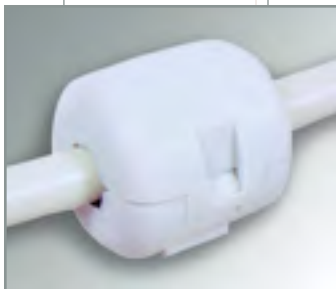

Ferrite assembly in fully enclosed nylon case; functional with wires and cables up to a 2.0" (50,8mm) diameter. Snap closed around wire by clasping shut to position assembly.

May also be mounted with a flat-head screw through the .120" (3,0mm) diameter hole in the bottom by temporarily removing lower ferrite half.

Very effective from 100 MHz to 1 GHz; peak attenuation at 700 MHz. See pages 32 and 33 for impedance curve characteristics.

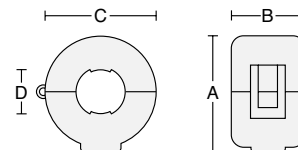

| PART No.  | A     |       | B     |      | C     |       | D     |      | IMPEDANCE IN OHMS            |              |
|-----------|-------|-------|-------|------|-------|-------|-------|------|------------------------------|--------------|
| CS25B1642 | .852  | 21,6  | .885  | 22,5 | .840  | 21,3  | .282  | 7,2  | 290 @ 700MHz                 |              |
| CS25B1937 | 1.182 | 30,0  | .780  | 19,8 | 1.188 | 30,2  | .425  | 10,8 | 305 @ 700MHz                 |              |
| CS25B1500 | 1.725 | 43,8  | 1.232 | 31,3 | 1.720 | 43,7  | .960  | 24,4 | 510 @ 700MHz                 |              |
| CS25B2000 | 2.350 | 59,7  | 1.851 | 47,0 | 2.309 | 58,6  | .960  | 24,4 | see page 31 for more details | 890 @ 700MHz |
| CS25B4000 | 4.500 | 114,2 | 1.851 | 47,0 | 4.687 | 110,0 | 1.960 | 49,8 | see page 31 for more details | 590 @ 700MHz |

## sleeve snap



Box-shaped ferrite assembly in enclosed nylon case. Various sizes are functional with wires up to .500" (12,7 mm) diameter. Simply clamp around cable or wire; plastic tabs at entry/exit ports apply pressure to cable surface to maintain mounting position. Options include foam adhesive pad on bottom.

Very effective from 100 MHz to 1 GHz; peak attenuation at 700 MHz. See pages 32 and 33 for impedance curve characteristics.

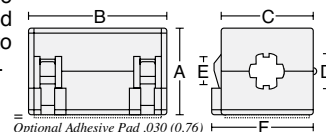

Available in standard colors gray (i.e., SS25B2030) and black (i.e., SS25B2030K)

Patent No. 5,764,125

| PART No.  | w/ Adhesive | A     |      | B     |      | C     |      | D    |      | E    |      | F     |      | IMPEDANCE IN OHMS |
|-----------|-------------|-------|------|-------|------|-------|------|------|------|------|------|-------|------|-------------------|
| SS25B2030 | AS25B2030   | .790  | 20,1 | 1.265 | 32,1 | .770  | 19,6 | .270 | 6,9  | .220 | 5,6  | .885  | 22,5 | 390 @ 700MHz      |
| SS25B2033 | AS25B2033   | .790  | 20,1 | 1.265 | 32,1 | .770  | 19,6 | .350 | 8,8  | .290 | 7,4  | .885  | 22,5 | 390 @ 700MHz      |
| SS25B2036 | AS25B2036   | 1.155 | 29,3 | 1.250 | 31,8 | 1.125 | 28,6 | .415 | 10,5 | .350 | 8,9  | 1.230 | 31,2 | 510 @ 700MHz      |
| SS25B2040 | AS25B2040   | 1.155 | 29,3 | 1.250 | 31,8 | 1.125 | 28,6 | .550 | 14,0 | .480 | 12,2 | 1.230 | 31,2 | 510 @ 700MHz      |

## sleeve snap

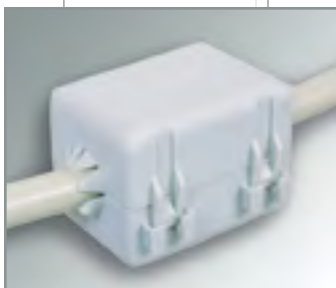

WITH VARIABLE DIAMETER END PORTS. Box-shaped ferrite assembly in fully enclosed nylon case. End ports are surrounded with flexible spring flutes to grip a range of cable diameters from .125" to .500" (3,2 to 12,7 mm). Special mounting options include foam adhesive pad on bottom.

Very effective from 100 MHz to 1 GHz; peak attenuation at 700 MHz. See pages 32 and 33 for impedance curve characteristics.

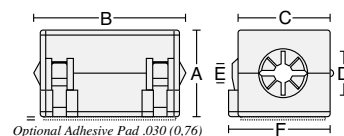

Available in standard colors gray (i.e., SS25B2037) and black (i.e., SS25B2037K)

Patent No. 5,003,278 and Patent No. 5,764,125

| PART No.  | w/ Adhesive | A     | B (ref.) | C     |      | D     |      | E    |      | F    |     | IMPEDANCE IN OHMS        |
|-----------|-------------|-------|----------|-------|------|-------|------|------|------|------|-----|--------------------------|
| SS25B2037 | AS25B2037   | .790  | 20,1     | 1.450 | 36,8 | .770  | 19,6 | .350 | 8,8  | .200 | 5,1 | .885 22,5 390 @ 700 MHz  |
| SS25B2032 | AS25B2032   | 1.155 | 29,3     | 1.450 | 36,8 | 1.125 | 28,6 | .500 | 12,7 | .200 | 5,1 | 1.230 31,2 510 @ 700 MHz |

## internal locking snap



WITH SECURE INTERNAL LOCKING SYSTEM. Cannot be reopened after snapping closed into position. Ensures that suppressor cannot be removed. Grip-lock tabs at entry/exit ports prevent longitudinal slippage on a range of cable diameters from .275" to .300" (7,0 to 7,6mm). Standard colors are computer gray (PMS#413), computer beige (PMS#468), black and natural white. A cost-effective alternative to over-molding.

Very effective from 100 MHz to 1 GHz; peak attenuation at 700 MHz. See pages 32 and 33 for impedance curve characteristics.

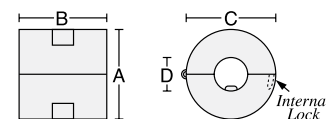

Patent Nos. 5,003,278 , 5,162,772 and 5,764,125

| PART No.   | A    | B (ref.) | C    |      | D    |      | COLOR | IMPEDANCE IN OHMS |                |              |
|------------|------|----------|------|------|------|------|-------|-------------------|----------------|--------------|
| IL25B0642W | .780 | 19,8     | .780 | 19,8 | .780 | 19,8 | .316  | 8,0               | NATURAL WHITE  | 290 @ 700MHz |
| IL25B0642G | .780 | 19,8     | .780 | 19,8 | .780 | 19,8 | .316  | 8,0               | COMPUTER GRAY  | 290 @ 700MHz |
| IL25B0642B | .780 | 19,8     | .780 | 19,8 | .780 | 19,8 | .316  | 8,0               | COMPUTER BEIGE | 290 @ 700MHz |
| IL25B0642K | .780 | 19,8     | .780 | 19,8 | .780 | 19,8 | .316  | 8,0               | BLACK          | 290 @ 700MHz |

## cable clamp



Ferrite assembly bonded to nylon strap; functional with wires and cables up to a 1.00" (25,4 mm) diameter. Holes are provided for screw mounting.

Very effective from 100 MHz to 1 GHz; peak attenuation at 700 MHz. See pages 32 and 33 for impedance curve characteristics.

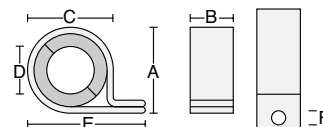

| PART No.  | A     | B    | C     |      | D     |      | E     | F    | IMPEDANCE IN OHMS                |
|-----------|-------|------|-------|------|-------|------|-------|------|----------------------------------|
| TC25B0642 | .785  | 19,9 | .630  | 16,0 | .785  | 19,9 | .320  | 8,1  | 1.335 33,9 .195 5,0 290 @ 700MHz |
| TC25B0937 | 1.127 | 28,6 | .551  | 14,0 | 1.127 | 28,6 | .449  | 11,4 | 1.677 42,6 .195 5,0 305 @ 700MHz |
| TC25B1500 | 1.628 | 41,4 | 1.000 | 25,4 | 1.628 | 41,4 | 1.000 | 25,4 | 2.150 55,5 .195 5,0 510 @ 700MHz |
| TC25B2000 | 2.125 | 54,0 | 1.500 | 38,1 | 2.125 | 54,0 | 1.000 | 25,4 | 2.860 72,6 .281 7,1 890 @ 700MHz |

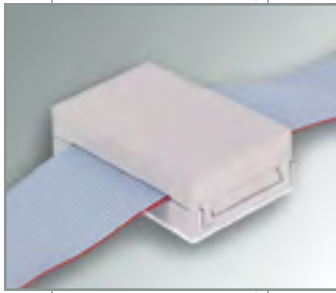

### flat cable clamp

WITH FULL OUTER ENCLOSURE AND ADHESIVE MOUNT. Ferrite assembly in fully enclosed nylon case for flat cables up to 40-conductor width. Internal grip-lock tabs apply pressure on cable to maintain mounting position. Very effective from 100 MHz to 1 GHz; peak attenuation at 700 MHz. See pages 32 and 33 for impedance curve characteristics.

Installs easily on any mounting surface by removing liner from foam adhesive base pad. Also available without the adhesive mounting pad for assembly with two flat head screws through the .120" (3,0 mm) diameter holes on 1.25" (31,8 mm) centers in the bottom by temporarily removing the lower ferrite half. Excellent for flex-circuits.

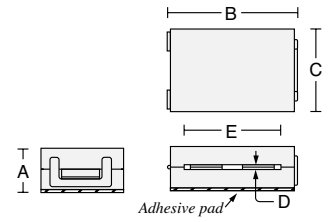

| PART No.  | w/o Adhesive | A    | B    | C    | D     | E     | IMPEDANCE IN OHMS |          |            |               |
|-----------|--------------|------|------|------|-------|-------|-------------------|----------|------------|---------------|
| RA25B2480 | RC25B2480    | .700 | 17,8 | 2.76 | 70,1  | 1.312 | 33,3              | .060 1,5 | 2.047 52,0 | 790 @ 700 MHz |
| RA25B4340 | RC25B4340    | .785 | 19,9 | 4.61 | 117,1 | 1.312 | 33,3              | .104 2,6 | 3.240 82,3 | 930 @ 700 MHz |



### flat cable clamp

WITH ADHESIVE MOUNT. Ferrite assembly bonded in nylon mounting clamp; easily installed by peeling protective paper strip from base and pressing into place. Two sizes accommodate all flat cables up to 40-conductor width.

Very effective from 100 MHz to 1 GHz; peak attenuation at 700 MHz. See pages 32 and 33 for impedance curve characteristics.

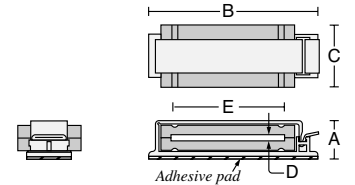

| PART No.  | w/o Adhesive | A    | B    | C     | D    | E     | IMPEDANCE IN OHMS |          |            |               |
|-----------|--------------|------|------|-------|------|-------|-------------------|----------|------------|---------------|
| FA25B0121 | FC25B0121    | .520 | 13,2 | 1.790 | 45,5 | .750  | 19,1              | .060 1,5 | 1.010 25,7 | 245 @ 700 MHz |
| FA25B2480 | FC25B2480    | .800 | 20,3 | 3.180 | 80,8 | 1.125 | 28,6              | .060 1,5 | 2.047 52,0 | 790 @ 700 MHz |

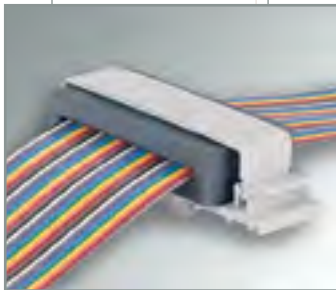

### flat cable clamp

WITH SINGLE PRESS FIT MOUNT. Ferrite assembly bonded in nylon mounting clamp; easily installed by pressing the integral spring tab fastener into a .250" (6,4mm) diameter hole. Two sizes accommodate all flat cables up to 40-conductor width. Fits substrates up to .070" (1,8mm) thickness.

Very effective from 100 MHz to 1 GHz; peak attenuation at 700 MHz. See pages 32 and 33 for impedance curve characteristics.

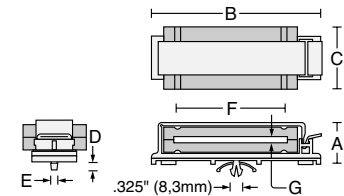

| PART No.  | A    | B    | C     | D    | E     | F    | G    | IMPEDANCE IN OHMS |          |            |          |              |
|-----------|------|------|-------|------|-------|------|------|-------------------|----------|------------|----------|--------------|
| FF25B0121 | .475 | 12,7 | 1.790 | 45,5 | .750  | 19,1 | .325 | 8,3               | .240 6,1 | 1.010 25,7 | .060 1,5 | 245 @ 700MHz |
| FF25B2480 | .800 | 20,3 | 3.180 | 80,8 | 1.125 | 28,6 | .280 | 7,1               | .183 4,6 | 2.047 52,0 | .060 1,5 | 790 @ 700MHz |



### flat cable clamp

WITH DUAL PRESS FIT MOUNTS. Ferrite assembly bonded in nylon mounting clamp; easily installed by pressing the integral spring tab fasteners into two .219" (5,6mm) diameter holes. One size accommodates all flat cables up to 40-conductor width. Fits substrates up to .070" (1,8mm) thickness.

Very effective from 100 MHz to 1 GHz; peak attenuation at 700 MHz. See pages 32 and 33 for impedance curve characteristics.

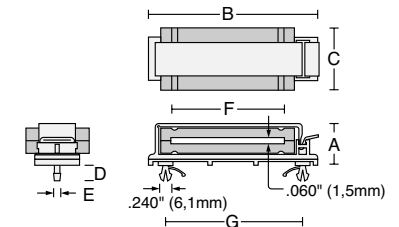

| PART No.  | A    | B    | C     | D    | E     | F    | G    | IMPEDANCE IN OHMS |          |            |            |              |
|-----------|------|------|-------|------|-------|------|------|-------------------|----------|------------|------------|--------------|
| FD25B2480 | .800 | 20,3 | 3.180 | 80,8 | 1.125 | 28,6 | .280 | 7,1               | .183 4,6 | 2.047 52,0 | 2.550 64,8 | 790 @ 700MHz |

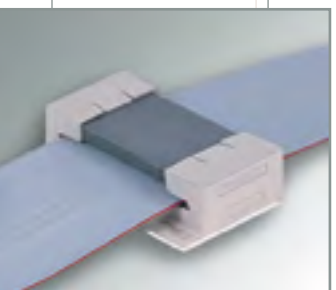

### flat cable clamp

WITH SPLIT END CAPS, ADHESIVE MOUNT. Ferrite assembly press-fitted into a pair of nylon end caps with adhesive foam mounting pads. Two sizes accommodate flat cables up to 40-conductor width.

Very effective from 100 MHz to 1 GHz; peak attenuation at 700 MHz. See pages 32 and 33 for impedance curve characteristics.

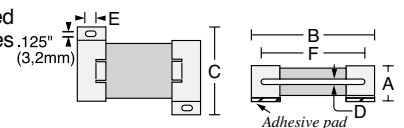

| PART No.  | w/o Adhesive | A    | B    | C     | D     | E     | F    | IMPEDANCE IN OHMS |          |            |               |
|-----------|--------------|------|------|-------|-------|-------|------|-------------------|----------|------------|---------------|
| SA25B0121 | SE25B0121    | .405 | 10,3 | 1.315 | 33,4  | 1.190 | 30,2 | .060 1,5          | .245 5,7 | 1.010 25,7 | 245 @ 700 MHz |
| SA25B2480 | SE25B2480    | .655 | 16,6 | 2.570 | 65,3  | 1.829 | 46,5 | .060 1,5          | .245 5,7 | 2.047 52,0 | 790 @ 700 MHz |
| SA25B4340 | SE25B4340    | .655 | 16,6 | 4.460 | 113,3 | 1.829 | 46,5 | .104 2,6          | .245 5,7 | 3.240 82,3 | 930 @ 700 MHz |



### sleeve snap

Box-shaped ferrite assembly in enclosed nylon case. Various sizes are functional with wires up to .400" (10,2 mm) diameter. Simply clamp around cable or wire; plastic tabs at entry/exit ports apply pressure to cable surface to maintain mounting position. Options include foam adhesive pad on bottom.

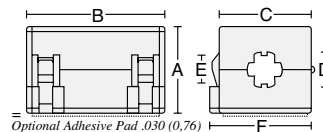

Available in standard colors gray (i.e., SS20B2030) and black (i.e., SS20B2030K)

Patent No. 5,764,125

| PART No.  | w/ Adhesive | A    | B    | C     | D    | E    | F    |      |      |      |     |       |      |
|-----------|-------------|------|------|-------|------|------|------|------|------|------|-----|-------|------|
| SS20B2030 | AS20B2030   | .790 | 20,1 | 1.265 | 32,1 | .770 | 19,6 | .270 | 6,9  | .220 | 5,6 | .885  | 22,5 |
| SS20B2033 | AS20B2033   | .790 | 20,1 | 1.265 | 32,1 | .770 | 19,6 | .350 | 8,8  | .290 | 7,4 | .885  | 22,5 |
| SS20B2041 | AS20B2041   | .965 | 24,5 | 1.285 | 32,6 | .930 | 23,6 | .450 | 11,4 | .380 | 9,7 | 1.035 | 26,3 |

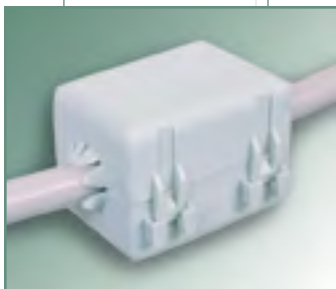

### sleeve snap

WITH VARIABLE DIAMETER END PORTS. Box-shaped ferrite assembly in fully enclosed nylon case. End ports are surrounded with flexible spring flutes to grip a range of cable diameters from .125" to .400" (3,2 to 10,2 mm). Special mounting options include foam adhesive pad on bottom.

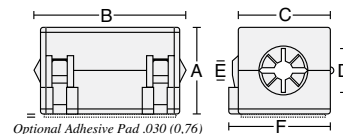

Patent No. 5,003,278 and Patent No. 5,764,125

| PART No.  | w/ Adhesive | A    | B (ref.) | C     | D    | E    | F    |      |      |      |     |       |      |
|-----------|-------------|------|----------|-------|------|------|------|------|------|------|-----|-------|------|
| SS20B2034 | AS20B2034   | .585 | 14,9     | 1.250 | 31,8 | .585 | 14,9 | .250 | 6,4  | .120 | 3,0 | .680  | 17,3 |
| SS20B2037 | AS20B2037   | .790 | 20,1     | 1.450 | 36,8 | .770 | 19,6 | .350 | 8,8  | .200 | 5,1 | .885  | 22,5 |
| SS20B2042 | AS20B2042   | .965 | 24,5     | 1.480 | 37,6 | .930 | 23,6 | .425 | 10,8 | .170 | 4,3 | 1.035 | 26,3 |



### cable snap for cable bundles

Ferrite assembly in fully enclosed nylon case; functional with wires and cables up to a 2.0" (50,8mm) diameter. Snap closed around wire by clasping shut to position assembly.

May also be mounted with a flat-head screw through the .120" (3,0mm) diameter hole in the bottom by temporarily removing lower ferrite half.

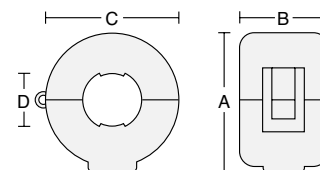

| PART No.  | A     | B     | C     | D    |       |       |       |      |
|-----------|-------|-------|-------|------|-------|-------|-------|------|
| CS20B1500 | 1.725 | 43,8  | 1.232 | 31,3 | 1.720 | 43,7  | .960  | 24,4 |
| CS20B2000 | 2.350 | 59,7  | 1.851 | 47,0 | 2.309 | 58,6  | .960  | 24,4 |
| CS20B4000 | 4.500 | 114,2 | 1.851 | 47,0 | 4.687 | 119,0 | 1.960 | 49,8 |



### cable clamp for cable bundles

Ferrite assembly bonded to nylon strap; functional with wires and cables up to a 1.00" (25,4 mm) diameter. Holes are provided for screw mounting.

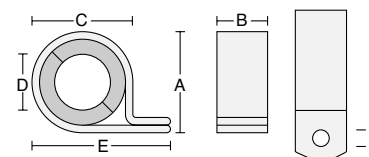

| PART No.  | A     | B    | C     | D    | E     | F    |       |      |       |      |      |     |
|-----------|-------|------|-------|------|-------|------|-------|------|-------|------|------|-----|
| TC20B1500 | 1.628 | 41,4 | 1.000 | 25,4 | 1.628 | 41,4 | 1.000 | 25,4 | 2.150 | 55,5 | .195 | 5,0 |
| TC20B2000 | 2.125 | 54,0 | 1.500 | 38,1 | 2.125 | 54,0 | 1.000 | 25,4 | 2.860 | 72,6 | .281 | 7,1 |



### solid beads

Sizes up to .430" I.D. (10,9 mm) for applications where it is possible to assemble the ferrite suppressor before the cable ends are terminated.



| PART No.  | A     | B    | C    |      |      |      |
|-----------|-------|------|------|------|------|------|
| 20B0562-2 | 1.125 | 28,6 | .562 | 14,2 | .250 | 6,4  |
| 20B0736-0 | 1.125 | 28,6 | .736 | 18,7 | .430 | 10,9 |

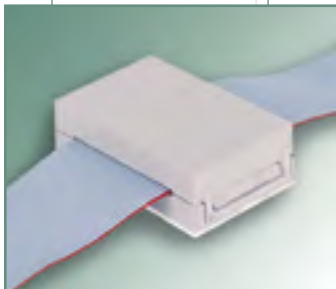

### flat cable clamp

WITH FULL OUTER ENCLOSURE AND ADHESIVE MOUNT. Ferrite assembly in fully enclosed nylon case. Two sizes functional with flat cables up to 40-conductor widths. Internal grip-lock tabs apply pressure on cable to maintain mounting position.

Installs easily on any mounting surface by removing liner from foam adhesive base pad. Excellent for flex-circuits.

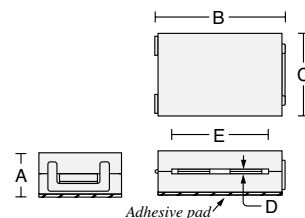

| PART No.  | w/o Adhesive | A    | B    | C    | D    | E          |          |            |
|-----------|--------------|------|------|------|------|------------|----------|------------|
| RA20B1729 | RC20B1729    | .700 | 17,8 | 2.03 | 51,6 | 1.312 33,3 | .060 1,5 | 1.355 34,4 |
| RA20B2480 | RC20B2480    | .700 | 17,8 | 2.76 | 70,1 | 1.312 33,3 | .060 1,5 | 2.047 52,0 |



### flat cable clamp

WITH ADHESIVE MOUNT. Ferrite assembly bonded in nylon mounting clamp; easily installed by peeling protective paper strip from base and pressing into place. For flat cables up to 40-conductor width 2.00" (50,8 mm).

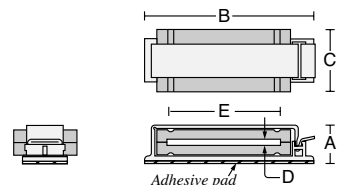

| PART No.  | w/o Adhesive | A    | B    | C     | D    | E          |          |            |
|-----------|--------------|------|------|-------|------|------------|----------|------------|
| FA20B1729 | FC20B1729    | .800 | 20,3 | 2.430 | 61,7 | 1.125 28,6 | .060 1,5 | 1.355 34,4 |
| FA20B2480 | FC20B2480    | .800 | 20,3 | 3.180 | 80,8 | 1.125 28,6 | .060 1,5 | 2.047 52,0 |

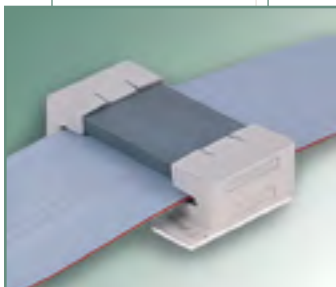

### flat cable clamp

WITH SPLIT END CAPS, ADHESIVE MOUNT. Ferrite assembly press-fitted into a pair of nylon end caps with adhesive foam mounting pads. For flat cables up to 40-conductor width 2.00" (50,8 mm).

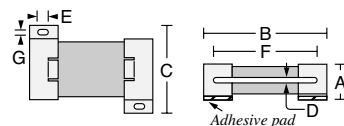

| PART No.  | w/o Adhesive | A    | B    | C     | D    | E          | F        | G        |            |          |
|-----------|--------------|------|------|-------|------|------------|----------|----------|------------|----------|
| SA20B1729 | SE20B1729    | .655 | 16,6 | 1.849 | 47,0 | 1.829 46,5 | .060 1,5 | .245 5,7 | 1.355 34,4 | .125 3,2 |
| SA20B2480 | SE20B2480    | .655 | 16,6 | 2.570 | 65,3 | 1.829 46,5 | .060 1,5 | .245 5,7 | 2.047 52,0 | .125 3,2 |



### low profile solids

ULTRA-THIN. Excellent for thin flex circuits and flat cables. Two sizes accommodate cable widths up to 1.325" (33,7 mm).

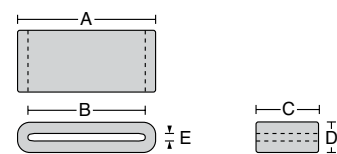

| PART No. | A          | B          | C          | D        | E        |
|----------|------------|------------|------------|----------|----------|
| 20R1260  | 1.260 32,0 | 1.010 25,7 | 1.125 28,6 | .300 7,6 | .051 1,3 |
| 20R1575  | 1.575 40,0 | 1.325 33,7 | 1.125 28,6 | .300 7,6 | .051 1,3 |



### low profile solids

ULTRA-THIN WITH SHOCK MOUNT ADHESIVE FOAM BASE. Excellent for thin flex circuits and flat cables. Two sizes accommodate cable widths up to 1.325" (33,7mm). High tack adhesive mounting pad secures to almost any surface. Can be stacked one on top of another.

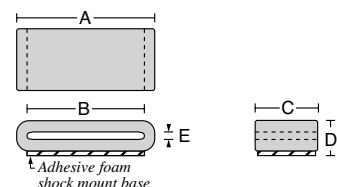

| PART No.  | A          | B          | C          | D        | E        |
|-----------|------------|------------|------------|----------|----------|
| SM20R1260 | 1.260 32,0 | 1.010 25,7 | 1.125 28,6 | .330 8,4 | .051 1,3 |
| SM20R1575 | 1.575 40,0 | 1.325 33,7 | 1.125 28,6 | .330 8,4 | .051 1,3 |



## 3-Steps to Reducing RFID Interference

Radio Frequency Identification (RFID) is a rapidly expanding technology with new applications emerging at a remarkable rate. From management of warehouse inventory to identification of patients in a medical setting, proper deployment and unimpeded communication between RFID readers and tags is paramount to successful operation.

One of the major considerations when implementing an RFID system is the effect of unwanted RF interference between Readers and Tags. Most workplaces have hundreds if not thousands of electronic devices that create unwanted interference, including computers, Bluetooth networks, wireless networks, motors, conveyors and robots. Actually, any device with a microchip and power cord or cable will emit RF energy which can interfere with the ability of the reader to receive a clean signal.



Leader Tech offers a simple "first-step" approach to reducing unwanted RF interference. We recommend the following:

### Identify Sources of RFID Interferences

The FerriShield CTK031 hand-held probe (see below) is one of the easiest ways to identify unwanted electro-magnetic interference. All you need to do is pass the probe over suspect sources. If the device detects RF emissions it alerts with an audible tone that intensifies as interference increases.

### Attach a Frequency-Specific RFID Ferrite to the Suspect Device

Samplings of our most popular RFID ferrites are shown on the following page. In addition, a free 32-piece engineering kit is provided with the purchase of any CTK031 Probe.

### Check If Interference Has Been Eliminated

After you have attached the cable-mounted ferrite, simply use the hand-held RF probe to confirm that the ferrite has eliminated the unwanted interference.

### CTK031 – SCAN EM-C PROBE SET WITH DEMO FIXTURE

Contains both CTM030 electric and CTM032 magnetic near-field probes along with a step-by-step guide, an EMC Demo Fixture, and cables with adapters for spectrum analyzer, oscilloscope or multimeter. Free ferrite engineering kit included. See information at lower right.



#### FREE #EK28B0032 FERRITE ENGINEERING KIT WITH EITHER SCANEM PROBE KIT PURCHASE

Our popular, wideband assortment of 32 unique configurations for RFID EMI cable suppression.

| CTK031 W/ BOTH PROBES     | PROBE   | PROBE                                   |
|---------------------------|---|---|
| Parameters                | CTM030  | CTM032                                  |
| Fields                    | Electric  | Magnetic                                |
| Frequency Response        | 2MHz - 2GHz   | 1MHz - 1GHz                             |
| RF Output                 | Yes   | Yes                                     |
| DC Output to a multimeter | Yes   | Yes                                     |
| Sensitivity (typical)     | -10dBm/(V/m)  | -20dBm/ma                               |
| Connector                 | SMB/BNC   | SMB/BNC                                 |
| Dimensions (approx.)      | 6.18" x 1.21" x 0.76" (157 x 31 x 20mm)                 | 6.18" x 1.21" x 0.76" (157 x 31 x 20mm) |
| Weight (approx.)          | 2.25oz (65g)  | 2.25oz (65g)                            |
| Battery (included)        | 2 x AAA   | 2 x AAA                                 |
| LED Bar Graph             | 5 LED color bar   | 5 LED color bar                         |
| Audio Indication          | Speaker (tone pitch proportional to the field strength) |   |



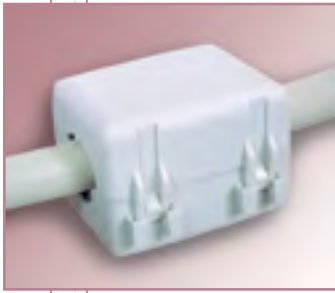

## sleeve snap for round cables

Three common sizes in three frequency-specific formulations. Box-shaped assembly snaps over cables up to .400" (10,1mm) diameter. Optional foam adhesive mounting pad on bottom.

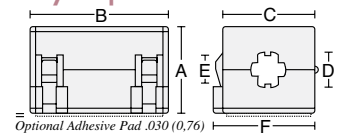

| PART No.  | w/adhesive | A         | B          | C         | D         | E        | F          | Target Frequency/Range | Impedance in Ohms |
|-----------|------------|-----------|------------|-----------|-----------|----------|------------|------------------------|-------------------|
| SS28B2030 | AS28B2030  | .790 20,1 | 1.265 32,1 | .770 19,6 | .270 6,9  | .220 5,6 | .885 22,5  | 13.56MHz               | 200 @ 100MHz      |
| SS28B2033 | AS28B2033  | .790 20,1 | 1.265 32,1 | .770 19,6 | .350 8,8  | .290 7,4 | .885 22,5  | 13.56MHz               | 200 @ 100MHz      |
| SS28B2041 | AS28B2041  | .965 24,5 | 1.285 32,6 | .930 23,6 | .450 11,4 | .380 9,7 | 1.035 26,3 | 13.50MHz               | 238 @ 100MHz      |
| SS25B2030 | AS25B2030  | .790 20,1 | 1.265 32,1 | .770 19,6 | .270 6,9  | .220 5,6 | .885 22,5  | 433.92MHz & 860-930MHz | 340 @ 700MHz      |
| SS25B2033 | AS25B2033  | .790 20,1 | 1.265 32,1 | .770 19,6 | .350 8,8  | .290 7,4 | .885 22,5  | 433.92MHz & 860-930MHz | 290 @ 700MHz      |
| SS20B2030 | AS20B2030  | .790 20,1 | 1.265 32,1 | .770 19,6 | .270 6,9  | .220 5,6 | .885 22,5  | 2.45GHz                | per application   |
| SS20B2033 | AS20B2033  | .790 20,1 | 1.265 32,1 | .770 19,6 | .350 8,8  | .290 7,4 | .885 22,5  | 2.45GHz                | per application   |
| SS20B2041 | AS20B2041  | .965 24,5 | 1.285 32,6 | .930 23,6 | .450 11,4 | .380 9,7 | 1.035 26,3 | 2.45GHz                | per application   |

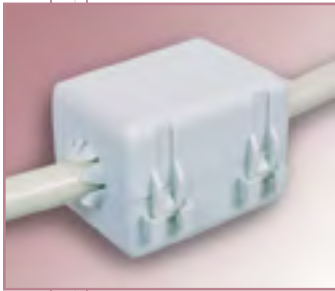

## sleeve snap for round cables

WITH VARIABLE DIAMETER END PORTS. Four sizes fit cable diameters from .125" to .500" (3,2 to 12,7mm); end ports are surrounded by flexible spring flutes to grip a range of diameters. Three choices of frequency-specific material formulations. Optional foam adhesive mounting pad on bottom.

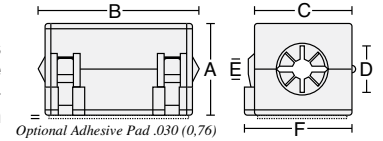

| PART No.  | w/adhesive | A          | B(ref.)    | C          | D         | E        | F          | Target Frequency/Range | Impedance in Ohms |
|-----------|------------|------------|------------|------------|-----------|----------|------------|------------------------|-------------------|
| SS28B2034 | AS28B2034  | .585 14,9  | 1.250 31,8 | .585 14,9  | .250 6,4  | .120 3,0 | .680 17,3  | 13.56MHz               | 220 @ 100MHz      |
| SS28B2037 | AS28B2037  | .790 20,1  | 1.450 36,8 | .770 19,6  | .350 8,8  | .200 5,1 | .885 22,5  | 13.56MHz               | 200 @ 100MHz      |
| SS28B2042 | AS28B2042  | .965 24,5  | 1.480 37,6 | .930 23,6  | .425 10,8 | .170 4,3 | 1.035 26,3 | 13.56MHz               | 238 @ 100MHz      |
| SS28B2032 | AS28B2032  | 1.155 29,3 | 1.450 36,8 | 1.125 28,6 | .500 12,7 | .200 5,1 | 1.230 31,2 | 13.56MHz               | 238 @ 100MHz      |
| SS25B2037 | AS25B2037  | .790 20,1  | 1.450 36,8 | .770 19,6  | .350 8,8  | .200 5,1 | .885 22,5  | 433.92MHz & 860-930MHz | 390 @ 700MHz      |
| SS25B2032 | AS25B2032  | 1.155 29,3 | 1.450 36,8 | 1.125 28,6 | .500 12,7 | .200 5,1 | 1.230 31,2 | 433.92MHz & 860-930MHz | 510 @ 700MHz      |
| SS20B2034 | AS20B2034  | .585 14,9  | 1.250 31,8 | .585 14,9  | .250 6,4  | .120 3,0 | .680 17,3  | 2.45GHz                | per application   |
| SS20B2037 | AS20B2037  | .790 20,1  | 1.450 36,8 | .770 19,6  | .350 8,8  | .200 5,1 | .885 22,5  | 2.45GHz                | per application   |
| SS20B2042 | AS20B2042  | .965 24,5  | 1.480 37,6 | .930 23,6  | .425 10,8 | .170 4,3 | 1.035 26,3 | 2.45GHz                | per application   |



## cable snap for round cables

Ferrite assembly in fully enclosed nylon case; functional with cables and bundles up to a 2.0" (50,8mm) diameter. Three choices of frequency-specific material formulations. Optional foam adhesive mounting pad on bottom.

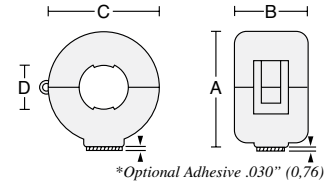

| PART No.  | w/adhesive | A           | B          | C           | D          | Target Frequency/Range | Impedance in Ohms |
|-----------|------------|-------------|------------|-------------|------------|------------------------|-------------------|
| CS28B1642 | CA28B1642  | .852 21,6   | .885 22,5  | .840 21,3   | .282 7,2   | 13.56MHz               | 100 @ 100MHz      |
| CS28B1805 | CA28B1805  | 1.040 26,4  | .667 16,9  | 1.025 26,4  | .340 8,6   | 13.56MHz               | 73 @ 100MHz       |
| CS28B1937 | CA28B1937  | 1.182 30,0  | .780 19,6  | 1.188 30,2  | .425 10,8  | 13.56MHz               | 117 @ 100MHz      |
| CS28B1984 | CA28B1984  | 1.218 30,9  | .705 17,9  | 1.220 31,0  | .525 13,3  | 13.56MHz               | 62 @ 100MHz       |
| CS28B1501 | CA28B1501  | 1.725 43,8  | 1.232 31,3 | 1.720 43,7  | .710 18,0  | 13.56MHz               | 177 @ 100MHz      |
| CS28B1500 | CA28B1500  | 1.725 43,8  | 1.232 31,3 | 1.720 43,7  | .960 24,4  | 13.56MHz               | 133 @ 100MHz      |
| CS28B2000 | CA28B2000  | 2.350 59,7  | 1.851 47,0 | 2.309 58,6  | .960 24,4  | 13.56MHz               | 380 @ 100MHz      |
| CS28B4000 | CA28B4000  | 4.500 114,2 | 1.851 47,0 | 4.687 119,0 | 1.960 49,8 | 13.56MHz               | 290 @ 100MHz      |
| CS25B1642 | CA25B1642  | .852 21,6   | .885 22,5  | .840 21,3   | .282 7,2   | 433.92MHz & 860-930MHz | 290 @ 700MHz      |
| CS25B1937 | CA25B1937  | 1.182 30,0  | .780 19,6  | 1.188 30,2  | .425 10,8  | 433.92MHz & 860-930MHz | 305 @ 700MHz      |
| CS25B1500 | CA25B1500  | 1.725 43,8  | 1.232 31,3 | 1.720 43,7  | .960 24,4  | 433.92MHz & 860-930MHz | 570 @ 700MHz      |
| CS25B2000 | CA25B2000  | 2.350 59,7  | 1.851 47,0 | 2.309 58,6  | .960 24,4  | 433.92MHz & 860-930MHz | 890 @ 700MHz      |
| CS25B4000 | CA25B4000  | 4.500 114,2 | 1.851 47,0 | 4.687 119,0 | 1.960 49,8 | 433.92MHz & 860-930MHz | 590 @ 700MHz      |
| CS20B1500 | CA20B1500  | 1.725 43,8  | 1.232 31,3 | 1.720 43,7  | .960 24,4  | 2.45GHz                | per application   |
| CS20B2000 | CA20B2000  | 2.350 59,7  | 1.851 47,0 | 2.309 58,6  | .960 24,4  | 2.45GHz                | per application   |
| CS20B4000 | CA20B4000  | 4.500 114,2 | 1.851 47,0 | 4.687 119,0 | 1.960 49,8 | 2.45GHz                | per application   |



## flat cable clamp for flat cables

WITH OPTIONAL ADHESIVE MOUNTING. Ferrite assembly clamps over flat cables up to 64-conductor widths 3.24" (82,3mm). Optional adhesive pad mounts on bottom; or, may be mounted with flat-head screws through the .125" (3,0mm) diameter holes on 1.25" (31,8mm) centers in the bottom by temporarily removing the lower ferrite half.

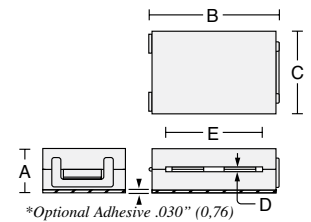

| PART No.  | w/adhesive | A         | B           | C          | D        | E          | Target Frequency/Range | Impedance in Ohms |
|-----------|------------|-----------|-------------|------------|----------|------------|------------------------|-------------------|
| RC28B1729 | RA28B1729  | .670 17,0 | 2.030 51,6  | 1.312 33,3 | .060 1,5 | 1.355 34,4 | 13.56MHz               | 200 @ 100MHz      |
| RC28B2480 | RA28B2480  | .670 17,0 | 2.760 70,1  | 1.312 33,3 | .060 1,5 | 2.047 52,0 | 13.56MHz               | 250 @ 100MHz      |
| RC28B3012 | RA28B3012  | .670 17,0 | 3.260 82,8  | 1.312 33,3 | .060 1,5 | 2.540 64,5 | 13.56MHz               | 286 @ 100MHz      |
| RC28B4340 | RA28B4340  | .755 19,2 | 4.610 117,1 | 1.312 33,3 | .104 2,6 | 3.240 82,3 | 13.56MHz               | 325 @ 100MHz      |
| RC25B2480 | RA25B2480  | .700 17,8 | 2.760 70,1  | 1.312 33,3 | .060 1,5 | 2.047 52,0 | 433.92MHz & 860-930MHz | 390 @ 700MHz      |
| RC25B4340 | RA25B4340  | .785 19,9 | 4.610 117,1 | 1.312 33,3 | .104 2,6 | 3.240 82,3 | 433.92MHz & 860-930MHz | 510 @ 700MHz      |
| RC20B1729 | RA20B1729  | .700 17,8 | 2.030 51,6  | 1.312 33,3 | .060 1,5 | 1.355 34,4 | 2.45GHz                | per application   |
| RC20B2480 | RA20B2480  | .700 17,8 | 2.760 70,1  | 1.312 33,3 | .060 1,5 | 2.047 52,0 | 2.45GHz                | per application   |



### engineering kit #EK28B0032

BISECTED FERRITES FOR APPLICATIONS UP TO 1 GHz WITH PEAK PROPERTIES AT 250MHz.

Our most popular engineering kit! Contains a large assortment of various sizes of ferrite assemblies from catalog pages 10 through 21. Manufactured in the most frequently used universal #28 wideband material formulation for all applications up to 1 GHz.

All catalog items are in stock at all times for immediate delivery.



### engineering kit #EK28B0021

SOLID FERRITES FOR APPLICATIONS UP TO 1 GHz WITH PEAK PROPERTIES AT 250MHz.

Sample assortment of twenty cylindrical and flat solid ferrite suppressors in universal #28 wideband material formulation for applications up to 1 GHz. Contains many of the cylindrical and flat rectangular designs shown on pages 15 and 19, including the "SM" shock mount versions.

See catalog pages 15 and 19 for all items available from stock for immediate delivery.



### saddle beads® engineering kit #EK28B27SB

FERRITES FOR APPLICATIONS UP TO 1 GHz WITH PEAK PROPERTIES AT 250MHz.

A wide variety of common sizes of our unique half-toroid, half-bead, half-sleeve and plate shapes for round wire, flat wire and PC board components. Manufactured in the most frequently used universal #28 wideband material formulation for all applications up to 1 GHz.

See catalog page 20 for all items available from stock for immediate delivery.



### engineering kit #EK33B0011, low frequency 30MHz peak

BISECTED FERRITES FOR APPLICATIONS FROM 1 TO 30MHz WITH PEAK PROPERTIES AT 30MHz.

Sample assortment containing nine of the most common configurations of ferrite assemblies manufactured in #33 material formulation. Specifically applicable in the 1-30 MHz range.

Contains part numbers TC33B0805, TC33B0984, CS33B1805, CV33B1984, FA33B2480, SS33B2033, SS33B2037, SS33B2032, SS33B2036. Other sizes available on a special order basis.

See catalog pages 22 and 23 for all items available from stock for immediate delivery. Most other catalog items are also available in this material on special order basis.



### engineering kit #EK25B0012, high frequency 700MHz peak

BISECTED FERRITES FOR APPLICATIONS UP TO 1 GHz WITH PEAK PROPERTIES AT 700MHz.

Sample assortment of ten popular stock items manufactured in our newest #25 high frequency material. Effective to 1.2 GHz with peak properties at 700 MHz.

Contains part numbers TC25B0642, TC25B0937, CS25B1642, SA25B0121, CV25B1937, FA25B2480, SS25B2033, SS25B2032, SS25B2037, SS25B2036. Other sizes available on a special order basis.

See catalog pages 24 and 25 for all items available from stock for immediate delivery. Most other catalog items are also available in this material on special order basis.



### engineering kit #EK20B0009, Bluetooth™

BISECTED AND SOLID FERRITES FOR APPLICATIONS CONCERNED WITH 2.45GHz OPERATIONS.

Sample assortment of nine popular stock items manufactured in #20 material formulation. Specifically applicable in the 2.45GHz frequency area.

Contains part numbers 20B0562-2, 20B0736-0, 20R1260, 20R1575, FA20B2480, SS20B2034, SS20B2037, SS20B2033, SS20B2042.

See catalog pages 26 and 27 for all items available from stock for immediate delivery. Most other catalog items are also available in this material on special order basis.



## suppression prototyping

Your lab is not complete without a selection of ferrite RFI-EMI suppressors on hand. Helpful during engineering evaluations, prototyping, emergencies, and eventually for final product compliance testing and documentation.

The engineering kits shown on page 30 contain a wide assortment of sizes, configurations and suppression levels for any insertion loss requirements.

The test fixtures shown below are indispensable problem-solving aids, useful in any laboratory.

When extra samples are required for your project, just a phone call to our customer service department will have them immediately on the way to you.

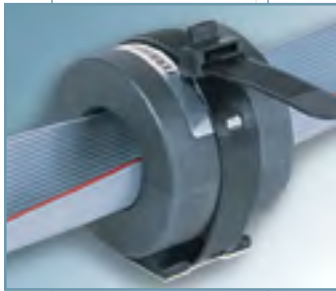

### empirical test fixtures – WITH QUICK-RELEASE STRAP

A handy R&D/test device for determining if a ferrite suppressor is feasible in a given situation. With this massive amount of insertion loss material applied to a circuit, a rough estimate of attenuation effect can be previewed. Afterwards, a properly configured ferrite assembly can be determined. Install on any cable data signal circuit by reassembling ferrite halves within the plastic strap. Even flat ribbon cables pass through the large opening. Available in our four standard material formulas.

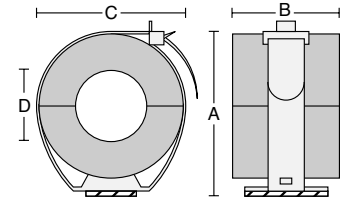

| PART No.  | A         | B         | C         | D         | MATERIAL        | IMPEDANCE IN OHMS |
|-----------|-----------|-----------|-----------|-----------|-----------------|-------------------|
| ET28B2000 | 2.53 64,3 | 1.50 38,1 | 2.00 50,8 | 1.00 25,4 | #28 formulation | 380 @ 100MHz      |
| ET33B2000 | 2.53 64,3 | 1.50 38,1 | 2.00 50,8 | 1.00 25,4 | #33 formulation | 210 @ 30MHz       |
| ET25B2000 | 2.53 64,3 | 1.50 38,1 | 2.00 50,8 | 1.00 25,4 | #25 formulation | 890 @ 700MHz      |
| ET20B2000 | 2.53 64,3 | 1.50 38,1 | 2.00 50,8 | 1.00 25,4 | #20 formulation | per application   |



### empirical test fixtures – IN FULLY ENCLOSED PLASTIC CASE

Another variation of the test fixture shown above – the same ferrite core encased in a heavy-duty hinged nylon plastic enclosure. A handy R&D/test device for determining if a ferrite suppressor is feasible in a given situation. With this massive amount of insertion loss material applied to a circuit, a rough estimate of attenuation effect can be previewed. Afterwards, a properly configured ferrite assembly can be determined. Install on any cable data signal circuit by clamping around the cable. Even flat ribbon cables pass through the large opening. Available in our four standard material formulas.

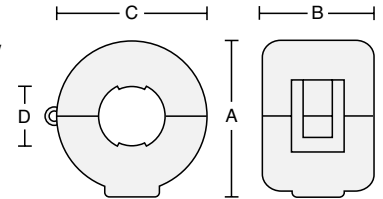

| PART No.  | A          | B          | C          | D         | MATERIAL        | IMPEDANCE IN OHMS |
|-----------|------------|------------|------------|-----------|-----------------|-------------------|
| CS28B2000 | 2.350 59,7 | 1.851 47,0 | 2.309 58,6 | .960 24,4 | #28 formulation | 380 @ 100MHz      |
| CS33B2000 | 2.350 59,7 | 1.851 47,0 | 2.309 58,6 | .960 24,4 | #33 formulation | 210 @ 30MHz       |
| CS25B2000 | 2.350 59,7 | 1.851 47,0 | 2.309 58,6 | .960 24,4 | #25 formulation | 890 @ 700MHz      |
| CS20B2000 | 2.350 59,7 | 1.851 47,0 | 2.309 58,6 | .960 24,4 | #20 formulation | per application   |



### special purpose large toroid clamp

IN FULLY ENCLOSED PLASTIC CASE WITH 2.0" (50,8mm) I.D.

Similar to other "CS" Empirical Test Fixtures above, except with a 4.0" 101,6mm O.D. and a 2.0" 50,8mm I.D. ferrite core. Available in four standard material formulas.

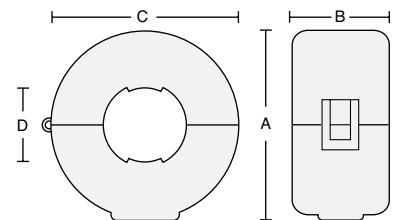

| PART No.  | A           | B          | C           | D          | MATERIAL        | IMPEDANCE IN OHMS |
|-----------|-------------|------------|-------------|------------|-----------------|-------------------|
| CS28B4000 | 4.500 114,2 | 1.851 47,0 | 4.687 119,0 | 1.960 49,8 | #28 formulation | 290 @ 100MHz      |
| CS33B4000 | 4.500 114,2 | 1.851 47,0 | 4.687 119,0 | 1.960 49,8 | #33 formulation | 140 @ 30MHz       |
| CS25B4000 | 4.500 114,2 | 1.851 47,0 | 4.687 119,0 | 1.960 49,8 | #25 formulation | 590 @ 700MHz      |
| CS20B4000 | 4.500 114,2 | 1.851 47,0 | 4.687 119,0 | 1.960 49,8 | #20 formulation | per application   |



### empirical test fixture – FOR FLAT CABLES AND FLEX-CIRCUITS

A high impedance R&D/test device for determining if a ferrite suppressor is feasible in a given situation. Specifically for flat cables and flex-circuits, with this massive amount of insertion loss material applied to a circuit the attenuation effect of the wideband ferrite core material can be previewed. Afterwards, a properly configured ferrite assembly can be determined. Installs on any cable data signal circuit up to 50-conductors by engaging the double clamps; quick-release design opens easily. Adhesive foam pads on bottom allow permanent mounting if desired. Available in our standard #28 wideband formula for frequencies from 10 MHz to 1 GHz.

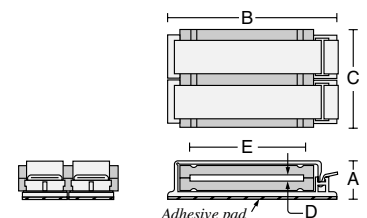

| PART No.  | A         | B          | C          | D        | E          | IMPEDANCE IN OHMS |
|-----------|-----------|------------|------------|----------|------------|-------------------|
| ET28B3000 | .800 20,3 | 3.700 94,0 | 1.500 38,1 | .060 1,5 | 2.540 64,5 | 370 @ 100MHz      |



# Attenuation Properties by Part Number

## IMPEDANCE VS. FREQUENCY-#28 MATERIAL.

The #28 formulation of suppression material is our most common product. It is an excellent wideband general purpose insertion loss absorber for frequencies from 10 MHz up to 1 GHz.

All of the impedance data below applies to the FerriShield® series which are specified by "28B" or the following alpha prefixes: TC, CS, CA, CW, CF, CV, FA, FF, FD, FX, IL, BA, BC, ET, SE, SA, PM, JB, CG, UG, HF, HI, HW, HA, SM, WC, CC, AC, PC, HC, HD, RC, RA, SF, SD, SS and USB. For specific performance by part number, find the alpha-numeric designation on the charts below according to the last seven digits of each catalog part number; i.e., for part number "CS28B1937" see "28B1937" on the chart.

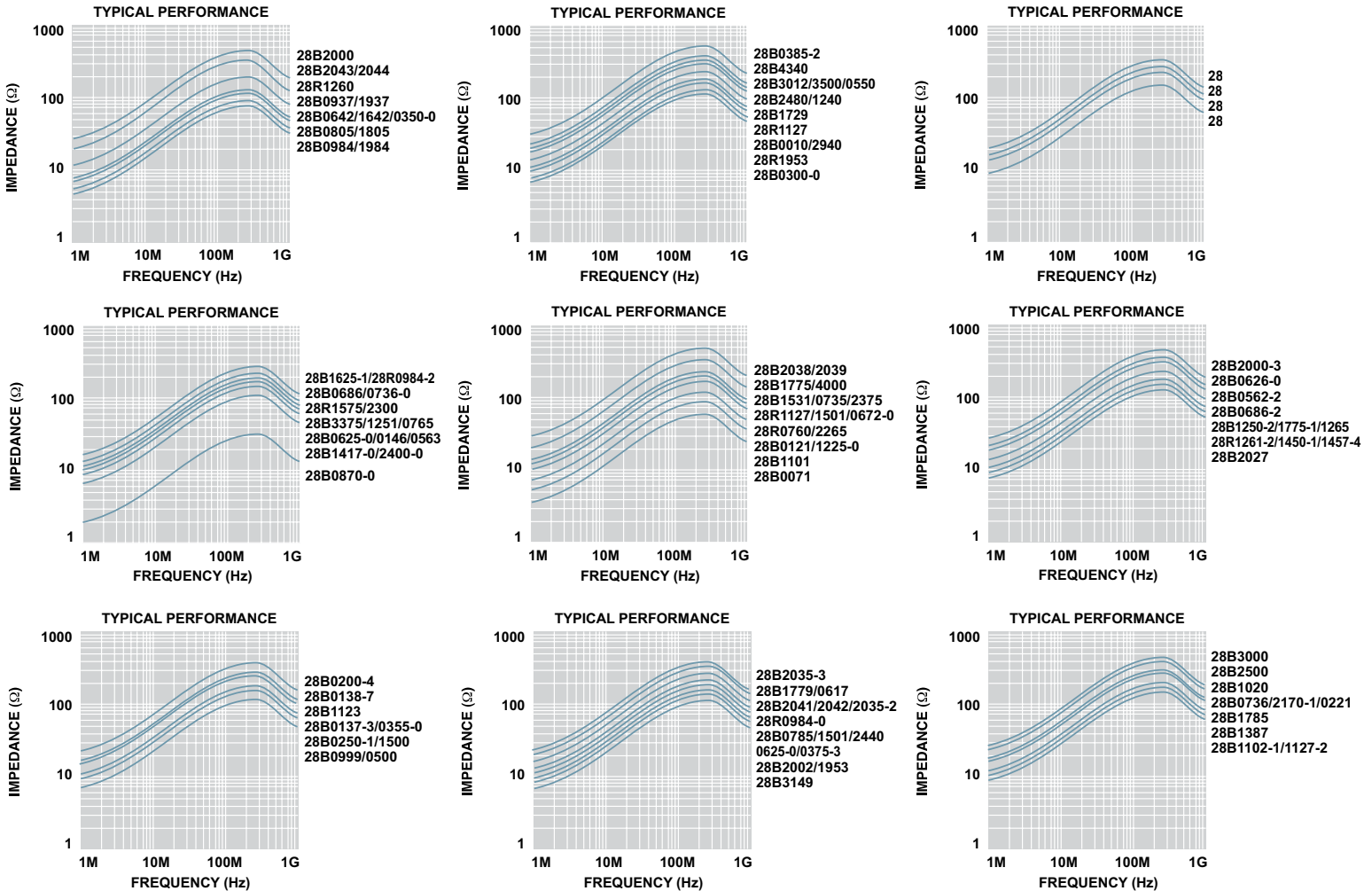

## IMPEDANCE VS. FREQUENCY-#33 MATERIAL.

The #33 formulation of suppression material is specifically applicable from 1 to 30 MHz with a decreasing effect beyond that range. The part numbers shown below are standard items available from stock and are the most commonly used configurations for those frequencies. Other sizes are available by special order.

All of the impedance data below applies to the FerriShield® series which are specified by "33B" or the following alpha prefixes: TC, CS, CA, CW, CF, CV, FA, FF, FD, ET, RC, RA, SE, SA and SS. For specific performance by part number, find the alpha-numeric designation on the charts below according to the last seven digits of each catalog part number, i.e. for part number "SS33B2032" see "33B2032" on the chart.

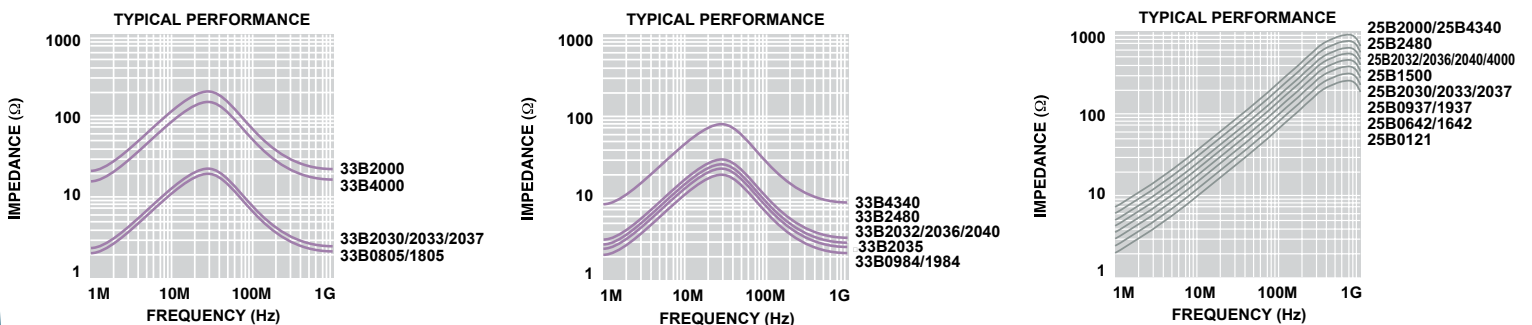

## IMPEDANCE VS. FREQUENCY-#25 MATERIAL.

The #25 formulation of suppression material is designed to address frequencies resulting from microprocessor speeds above 100MHz and harmonics peak interference at 700MHz with some attenuation effect up to 1.2GHz. Most of the product styles in this catalog are available by special order within a convenient lead time.

Impedance data for standard stock items is shown below. They are available in the component assemblies with the following alpha prefixes: TC, CS, CA, CW, CF, CV, FA, FF, FD, ET, RC, RA, SE, SA, IL and SS.

All attenuation data is derived from tests using an HP4191A attenuation analyzer with spring clip or binding post fixturing, and does not include the test wire resistance. All impedance readings are shown at nominal ±10% at 3 standard deviations from the mean.



# Material Properties

| Formula     | Description           | Application              | Permeability $\mu_i$ | $B_s$ @ 10 Oe Gauss | Loss Factor ( $1\mu_i^2$ ) x 10 <sup>-6</sup> | Curie Temp. °C | Vol. Res. ohm-cm  | Temperature Factor (20°C to 100°C) (x 10 <sup>5</sup> ) per °C |
|-------------|-----------------------|--------------------------|----------------------|---------------------|---|----------------|-------------------|--|
| 28 Material | Most popular wideband | 1MHz-1GHz, 250MHz peak   | 850                  | 3350                | 120 @ 1.0MHz                                  | ≥ 175          | x 10 <sup>5</sup> | < 7  |
| 33 Material | Low frequency         | 1MHz-60MHz, 30MHz peak   | 2700                 | 4800                | 7 @ .1MHz                                     | ≥ 200          | x 10 <sup>2</sup> | < 7  |
| 25 Material | High frequency        | 1MHz-1.2GHz, 700MHz peak | 125                  | 3650                | 32 @ 2.5MHz                                   | ≥ 225          | x 10 <sup>8</sup> | < 7  |
| 20 Material | Microwave             | 2.45GHz peak             | 20                   | 2700                | 500 @ 100.0MHz                                | ≥ 510          | x 10 <sup>5</sup> | < 7  |

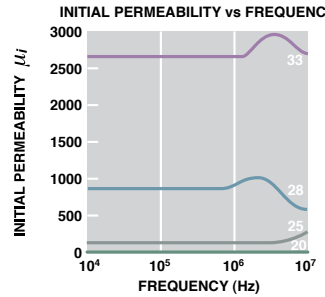
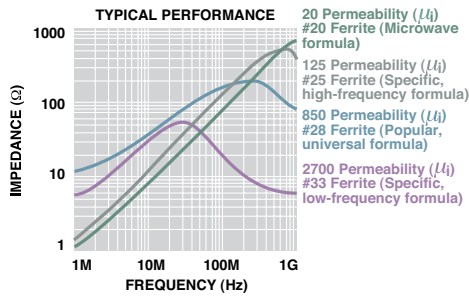
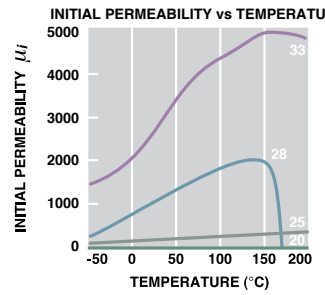
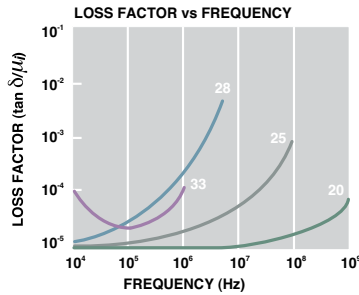

**CABLE SIZE BY PART NUMBER** The maximum recommended cable size or cable bundle diameter is shown below for each part number. A range of sizes indicates that the suppressor has a variable opening.

| Series          | Size              | Maximum recommended cable size-in. mm |
|-----------------|-------------------|---------------------------------------|
| TC, ET          | 0550              | .214 5,4 dia.                         |
| BA, BC          | 0617              | .276 7,0 dia.                         |
| IL              | 0642              | .320 8,1 dia.                         |
|                 | 0805              | .404 10,3 dia.                        |
|                 | 0937              | .449 11,4 dia.                        |
|                 | 1123              | .543 13,8 dia.                        |
|                 | 0984              | .591 15,0 dia.                        |
|                 | 1251              | .750 19,1 dia.                        |
|                 | 1501              | .750 19,1 dia.                        |
|                 | 1500              | 1.000 25,4 dia.                       |
|                 | 2000              | 1.000 25,4 dia.                       |
|                 | 0138-7            | .034 0,8 dia.                         |
| Special Purpose | 0137-3            | .051 1,3 dia.                         |
| Solid           | 0200-4            | .062 1,6 dia.                         |
|                 | 0300-0            | .069 1,8 dia.                         |
| Beads, PM       | 0250-1            | .125 3,2 dia.                         |
|                 | 0350-1            | .170 4,3 dia.                         |
|                 | 0355-0            | .187 4,8 dia.                         |
|                 | 0385-2            | .038 0,9 dia.                         |
|                 | 0375-3            | .200 5,0 dia.                         |
|                 | 0500-3            | .312 7,9 dia.                         |
|                 | 0562-2            | .250 6,3 dia.                         |
|                 | 0563-0            | .285 7,3 dia.                         |
|                 | 0625-0 and 0625-1 | .310 7,9 dia.                         |
|                 | 0626-0            | .133 3,4 dia.                         |
|                 | 0672-0            | .345 8,8 dia.                         |
|                 | 0686-2            | .375 9,5 dia.                         |
|                 | 0735-0            | .400 10,2 dia.                        |
|                 | 0736-0            | .410 10,4 dia.                        |
|                 | 1020-1            | .505 12,8 dia.                        |
|                 | 1102-1            | .630 16,0 dia.                        |
|                 | 1250-2            | .750 19,0 dia.                        |
|                 | 1387-1            | .880 22,4 dia.                        |
|                 | 2000-3            | 1.000 25,4 dia.                       |
| JB PM           | 0010              | .060 1,5 to .120 3,1 dia.             |
|                 | 3375              | .192 4,8 dia.                         |
|                 | 0625              | .310 7,9 dia.                         |
|                 | 1625              | .310 7,9 dia.                         |
|                 | 0686              | .375 9,5 dia.                         |
|                 | 2027              | .085 2,2 dia.                         |
| SS, AS          | 2034              | .125 3,2 to .170 4,3 dia.             |
| HI, HF          | 2031              | .200 5,1 dia.                         |
| HW, HA,         |                   |                                       |

| Series | Size    | Maximum recommended cable size- in. mm |                                      |
|--------|---------|--|--------------------------------------|
| USB    | 2035-3  | 3 holes ea. @ .203 5,2 dia.            |                                      |
|        | 2030    | .235 6,0 dia.                          |                                      |
|        | 2033    | .300 7,6 dia.                          |                                      |
|        | 2037    | .210 5,3 to .300 7,6 dia.              |                                      |
|        | 2035-2  | 2 holes ea. @ .335 8,5 dia.            |                                      |
|        | 2036    | .380 9,7 dia.                          |                                      |
|        | 2041    | .400 10,2 dia.                         |                                      |
|        | 2042    | .250 6,3 to .400 10,2 dia.             |                                      |
|        | 2032    | .250 6,3 to .500 12,7 dia.             |                                      |
|        | 2038    | .440 11,3 dia.                         |                                      |
|        | 2039    | .250 6,3 to .435 11,0 dia.             |                                      |
|        | 2040    | .500 12,7 dia.                         |                                      |
|        | 2035    | .730 18,5 dia.                         |                                      |
|        | 2043    | .730 18,5 dia.                         |                                      |
|        | 2044    | .500 12,7 to .710 18,0 dia.            |                                      |
|        | 2035-15 | 15 conductor, .038 x .75 1,0 x 19,1.   |                                      |
|        | ET, FA  | 0071                                   | 10 conductor, .060 x .500 1,5 x 12,7 |
| FF, FD | 0121    | 20 conductor, .060 x 1.00 1,5 x 25,4   |                                      |
| FC, SE | 0146    | 26 conductor, .060 x 1.25 1,5 x 31,8   |                                      |
| SA, RC | 0221    | 40 conductor, .060 x 2.00 1,5 x 50,8   |                                      |
| RA     | 0765    | 10 conductor, .038 x .500 1,0 x 12,7   |                                      |
|        | 1240    | 20 conductor, .040 x 1.00 1,0 x 25,4   |                                      |
|        | 1265    | 20 conductor, .038 x 1.00 1,0 x 25,4   |                                      |
|        | 1729    | 26 conductor, .060 x 1.25 1,5 x 31,8   |                                      |
|        | 1785    | 26 conductor .060 x 1.25 1,5 x 31,8    |                                      |
|        | 2265    | 40 conductor, .038 x 2.00 1,0 x 50,8   |                                      |
|        | 2375    | 34 conductor, .060 x 1.70 1,5 x 43,2   |                                      |
|        | 2440    | 40 conductor, .280 x 2.00 7,1 x 50,8   |                                      |
|        | 2480    | 40 conductor, .060 x 2.00 1,5 x 50,8   |                                      |
|        | 2500    | 40 conductor, .060 x 2.00 1,5 x 50,8   |                                      |
|        | 2940    | 50 conductor, .280 x 2.50 7,1 x 63,5   |                                      |
|        | 3000    | 50 conductor, .060 x 2.50 1,5 x 63,5   |                                      |
|        | 3012    | 50 conductor, .060 x 2.50 1,5 x 63,5   |                                      |
|        | 3500    | 60 conductor, .060 x 3.00 1,5 x 76,2   |                                      |
|        | 4340    | 64 conductor, .100 x 3.20 2,5 x 8,2    |                                      |
|        | FX      | 0984-0                                 | .030 x .700 0,76 x 17,8              |
|        |         | 0984-2                                 | .030 x .700 0,76 x 17,8              |
| 1261-2 |         | .030 x .980 0,76 x 24,9                |                                      |
| 1450-1 |         | .030 x 1.155 0,76 x 29,3               |                                      |
| 0984-0 |         | .018 x 1.29 95,0 x 32,8                |                                      |
|        |         |  |                                      |

| Series              | Size               | Maximum recommended cable size- in. mm |                                       |
|---------------------|--------------------|--|---------------------------------------|
| SM                  | 0760               | 10 conductor, .051 x .510 1,3 x 13,0   |                                       |
|                     | 0785               | 10 conductor, .145 x .500 3,7 x 12,7   |                                       |
|                     | and                | 1101                                   | 18 conductor, .059 x .900 1,5 x 22,8  |
|                     |                    | 1127/218                               | conductor, .060 x .900 1,5 x 22,8     |
|                     | Rectangular Solids | 1260                                   | 20 conductor, .051 x 1.01 1,3 x 25,7  |
|                     |                    | 1531                                   | 20 conductor, .210 x 1.00 12,9 x 25,4 |
|                     |                    | 1575                                   | 26 conductor, .051 x 1.30 1,3 x 33,0  |
|                     |                    | 1775                                   | 26 conductor, .060 x 1.30 1,5 x 33,0  |
|                     |                    | 1953                                   | 34 conductor, .059 x 1.70 1,5 x 43,1  |
|                     |                    | 2170                                   | 35 conductor, .050 x 1.72 1,2 x 43,7  |
| 2002                |                    | 40 conductor, .300 x 2.00 7,6 x 50,8   |                                       |
| 1779                |                    | 40 conductor, .066 x 2.00 1,6 x 50,8   |                                       |
| 2300                |                    | 40 conductor, .051 x 2.05 1,3 x 52,1   |                                       |
| 3149                |                    | 50 conductor, .075 x 2.70 1,9 x 68,5   |                                       |
| CS, CA CW, CF       | 1642 and 0642      | .300 7,6 dia.                          |                                       |
|                     | 1805 and 0805      | .345 8,7 dia.                          |                                       |
|                     | 1937 and 0937      | .400 10,2 dia.                         |                                       |
|                     | 1984 and 0984      | .520 13,2 dia.                         |                                       |
|                     | 1501               | .750 19,1 dia.                         |                                       |
|                     | 1500               | 1.000 25,4 dia.                        |                                       |
| CV                  | 2000               | 1.000 25,4 dia.                        |                                       |
|                     | 4000               | 2.000 50,8 dia.                        |                                       |
|                     | 1642               | .120 3,0 to .300 7,6 dia.              |                                       |
|                     | 1805               | .120 3,0 to .345 8,7 dia.              |                                       |
|                     | 1937               | .200 5,1 to .400 10,2 dia.             |                                       |
|                     | 1984               | .200 5,1 to .500 12,7 dia.             |                                       |
| Toroids             | 0870-0             | .540 13,7 dia.                         |                                       |
|                     | 0999-0             | .610 15,5 dia.                         |                                       |
|                     | 1225-0             | .750 19,1 dia.                         |                                       |
|                     | 1417-0             | .905 23,0 dia.                         |                                       |
|                     | 2400-0             | 1.400 35,6 dia.                        |                                       |
|                     | 2275               | 1.335 33,9 dia.                        |                                       |
| Extra Large Toroids | 3170               | 1.645 41,8 dia.                        |                                       |
|                     | 2945               | 1.775 45,1 dia.                        |                                       |
|                     | 4100               | 2.650 67,3 dia.                        |                                       |
|                     | 5950               | 3.675 93,3 dia.                        |                                       |
|                     | 5945               | 4.330 110,0 dia.                       |                                       |
|                     | 9210               | 6.665 169,3 dia.                       |                                       |
| SB                  | all                | per application - see page 14          |                                       |



## ScanEM probes

### NEAR-FIELD DETECTORS FOR EASY MEASUREMENT OF ELECTROMAGNETIC EMISSIONS

Shorten your development schedule and eliminate the need for product redesign by using proper EMC tools from the beginning of the project. ScanEM probes are diagnostic instruments for detecting, locating and measuring electromagnetic emissions. They are professional tools that don't require you to be an EMC expert to completely address emission compliance. They can reliably predict electromagnetic behavior of your products and locate emission sources in a matter of seconds. They detect the presence of an electromagnetic field and provide audio and visual indication of its relative strength either working by themselves, or as broadband active probes with any spectrum analyzer, oscilloscope or multimeter.

- Pinpoint exact sources of EMI
- Detect electric and magnetic fields separately
- Self-contained: palm-sized, no cords, no power supply or amplifier
- Audio output: tone changes indicate field strength
- LED color bar verifies relative field strength
- Squelch feature nullifies ambient to locate problem areas
- Output to spectrum analyzer or oscilloscope if desired
- DC output to multimeter for DC voltage as a function of field strength
- No disturbance of circuit under test - does not touch the circuit

### WHY NEAR-FIELD TESTING?

The standard radiated EMC test is done in the far field at 10'-0" (3M) from the product. This shows if there is a failure, but does not pinpoint the source of the problem. A near-field probe is a close-up inspection which permits quick product scanning for problem areas.

- PC board traces
- Trouble shooting
- Production quality control
- Service and repair
- Prequalification
- Cables, connectors – to a single circuit or pin
- Production quality control
- Service and repair
- Non-contact diagnostics – no circuit loading

A day spent at the beginning of a project preventing EMC problems saves days, even weeks, fixing these problems at the end.



## CTK015 – SCANEM-C PROBE SET

Complete kit contains electric and magnetic near-field probes. See specifications in chart below. Includes batteries, user guide, storage case and 6'-0" (1,8M) cable with adapters for connecting to spectrum analyzer, oscilloscope or multimeter. Free ferrite engineering kit included. See information at lower right.

| CTK015 W/ BOTH PROBES     | PROBE   | PROBE                                   |
|---------------------------|---|---|
| Parameters                | CTM030  | CTM032                                  |
| Fields                    | Electric  | Magnetic                                |
| Frequency Response        | 2MHz - 2GHz   | 1MHz - 1GHz                             |
| RF Output                 | Yes   | Yes                                     |
| DC Output to a multimeter | Yes   | Yes                                     |
| Sensitivity (typical)     | -10dBm/(V/m)  | -20dBm/mA                               |
| Connector                 | SMB/BNC   | SMB/BNC                                 |
| Dimensions (approx.)      | 6.18" x 1.21" x 0.76" (157 x 31 x 20mm)                 | 6.18" x 1.21" x 0.76" (157 x 31 x 20mm) |
| Weight (approx.)          | 2.25oz (65g)  | 2.25oz (65g)                            |
| Battery (included)        | 2 x AAA   | 2 x AAA                                 |
| LED Bar Graph             | 5 LED color bar   | 5 LED color bar                         |
| Audio Indication          | Speaker (tone pitch proportional to the field strength) |   |



## CTK031 – EMC COMPLIANCE ENGINEERING KIT WITH DEMO FIXTURE

Contains both CTM030 electric and CTM032 magnetic near-field probes shown above along with a step-by-step guide, an EMC Demo Fixture, and cables with adapters for spectrum analyzer, oscilloscope or multimeter. Free ferrite engineering kit included. See information at lower right.



DEMO FIXTURE



Observe how a ferrite reduces emission



Verify the effectiveness of shielding



**FREE #EK28B0032 FERRITE ENGINEERING KIT WITH EITHER SCANEM PROBE KIT PURCHASE**

Our popular, wideband assortment of 32 unique configurations for EMI cable suppression.

# Installation Guidelines

FerriShield® suppressors offer the finest performance alternatives by way of universal packaging, specific-purpose and general-purpose formulations. There are a few simple guidelines to assure expected results.

## 1. Cable Size

Refer to the chart on the page 33 for maximum recommended cable (or cable bundle) diameter. More than one cable may be inserted through the core opening since each circuit reacts with the ferrite material independently.

Consider the double loop knot shown in Attachment section below for snug attachment while greatly increasing the attenuation effect due to the increased magnetic path length. See also page 6, figures 3 and 4 for related technical information.

## 2. Closure

A tight fit between the cable outside dimensions; i.e. O.D., and the ferrite inside dimensions, i.e. I.D., will create the most effective magnetic path and a correspondingly higher attenuation ratio. Conversely, a loose fit is acceptable for many reasons, principally if a larger ferrite is desired, or a purpose-fit slack cable for tension control, flexing, etc.

## 3. Position

The suppressor should normally be located close to the cable termination where it exits the electronic enclosure.

Where a cable connects two enclosures containing RF sources, a suppressor on each end may be required.

For circuits within an enclosure, a position close to the RF source is best; however, other locations along the circuit may work just as well. This provides the opportunity to allow the suppressor, when affixed to the enclosure, to function also as a cable routing guide. See "Attachment" below for alternatives.

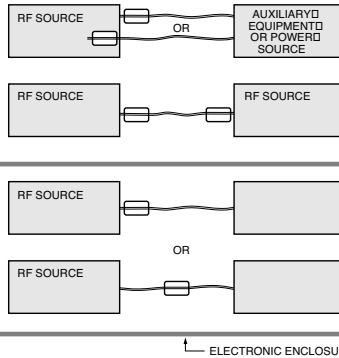

## 4. Attachment

Consider the various attachment alternatives shown below.



Tight grip on cable



Double loop knot



Hardware: screw, rivet



Press-fit tabs



Pressure sensitive adhesive



Cable tie wrap



Side-by-side double loop for flat cables

Each part number is a standard stock item and is carried in our inventories at all times for immediate delivery.

| Part Number | Page # | Part Number  | Page # | Part Number | Page #   | Part Number   | Page # |
|-------------|--------|--------------|--------|-------------|----------|---------------|--------|
| 20B0562-2   | 26     | AS20B2037    | 26,29  | CF28B0937   | 11       | FA20B1729     | 27     |
| 20B0736-0   | 26     | AS20B2041    | 26,29  | CF28B0984   | 11       | FA20B2480     | 27     |
| 20R1260     | 27     | AS20B2042    | 26,29  | CF28B1500   | 10       | FA25B0121     | 25     |
| 20R1575     | 27     | AS25B2030    | 24,29  | CF28B1501   | 10       | FA25B2480     | 25     |
| 21T3350     | 15     | AS25B2032    | 24,29  | CF28B1642   | 10       | FA28B0071     | 17     |
| 21T3937     | 15     | AS25B2033    | 24,29  | CF28B1805   | 10       | FA28B0121     | 17     |
| 21T4335     | 15     | AS25B2036    | 24     | CF28B1937   | 10       | FA28B1240     | 17     |
| 28B0137-3   | 15     | AS25B2037    | 24,29  | CF28B1984   | 10       | FA28B1265     | 17     |
| 28B0138-7   | 15     | AS25B2040    | 24     | CF28B2000   | 10       | FA28B1729     | 17     |
| 28B0200-4   | 15     | AS28B2027    | 12     | CS20B1500   | 26,29    | FA28B1785     | 18     |
| 28B0250-1   | 15     | AS28B2030    | 12,29  | CS20B2000   | 26,29,31 | FA28B2265     | 17     |
| 28B0300-0   | 15     | AS28B2031    | 12     | CS20B4000   | 26,29,31 | FA28B2375     | 17     |
| 28B0350-0   | 15     | AS28B2032    | 12,29  | CS25B1500   | 24,29    | FA28B2480     | 17     |
| 28B0355-0   | 15     | AS28B2033    | 12,29  | CS25B1642   | 24,29    | FA28B2500     | 18     |
| 28B0375-3   | 15     | AS28B2034    | 12,29  | CS25B1937   | 24,29    | FA28B2940     | 21     |
| 28B0385-2   | 15     | AS28B2035    | 12,14  | CS25B2000   | 24,29,31 | FA28B3000     | 18     |
| 28B0562-2   | 15     | AS28B2035-15 | 18     | CS25B4000   | 24,29,31 | FA28B3012     | 17     |
| 28B0563-0   | 15     | AS28B2035-2  | 14     | CS28B0642   | 11       | FA33B2480     | 23     |
| 28B0625-0   | 15     | AS28B2035-3  | 14     | CS28B0805   | 11       | FC20B1729     | 27     |
| 28B0625-1   | 15     | AS28B2036    | 12     | CS28B0937   | 11       | FC20B2480     | 27     |
| 28B0626-0   | 15     | AS28B2037    | 12,29  | CS28B0984   | 11       | FC25B0121     | 25     |
| 28B0672-0   | 15     | AS28B2040    | 12     | CS28B1500   | 10,29    | FC25B2480     | 25     |
| 28B0686-2   | 15     | AS28B2041    | 12,29  | CS28B1501   | 10,29    | FC28B0071     | 17     |
| 28B0735-0   | 15     | AS28B2042    | 12,29  | CS28B1642   | 10,29    | FC28B0121     | 17     |
| 28B0736-0   | 15     | AS28B2043    | 12     | CS28B1805   | 10,29    | FC28B1240     | 17     |
| 28B0785     | 19,21  | AS28B2044    | 12     | CS28B1937   | 10,29    | FC28B1729     | 17     |
| 28B0870-0   | 15     | AS33B2030    | 22     | CS28B1984   | 10,29    | FC28B1785     | 18     |
| 28B0999-0   | 15     | AS33B2032    | 22     | CS28B2000   | 10,29,31 | FC28B2375     | 17     |
| 28B1020-1   | 15     | AS33B2033    | 22     | CS28B4000   | 10,29,31 | FC28B2480     | 17     |
| 28B1101     | 19     | AS33B2035    | 22     | CS33B1805   | 22       | FC28B2500     | 18     |
| 28B1102-1   | 15     | AS33B2036    | 22     | CS33B1984   | 22       | FC28B3000     | 18     |
| 28B1225-0   | 15     | AS33B2037    | 22     | CS33B2000   | 22,31    | FC28B3012     | 17     |
| 28B1250-2   | 15     | AS33B2040    | 22     | CS33B4000   | 22,31    | FC33B2480     | 23     |
| 28B1387-1   | 15     | BA28B1251    | 14     | CTK015      | 34       | FD25B2480     | 25     |
| 28B1417-2   | 15     | BA28B1500    | 14     | CTK031      | 28,34    | FD28B2375     | 17     |
| 28B1775     | 19     | BA28B1501    | 14     | CV28B1642   | 10       | FD28B2480     | 17     |
| 28B1775-1   | 19     | BC28B1251    | 14     | CV28B1805   | 10       | FD28B2500     | 18     |
| 28B1779     | 19     | BC28B1500    | 14     | CV28B1937   | 10       | FD28B3000     | 18     |
| 28B2000-3   | 15     | BC28B1501    | 14     | CV28B1984   | 10       | FD28B3012     | 17     |
| 28B2002     | 19,21  | CA20B1500    | 29     | CW28B0642   | 11       | FD33B2480     | 23     |
| 28B2170-1   | 19     | CA20B2000    | 29     | CW28B0805   | 11       | FF25B0121     | 25     |
| 28B2275     | 15     | CA20B4000    | 29     | CW28B0937   | 11       | FF25B2480     | 25     |
| 28B2400-0   | 15     | CA25B1500    | 29     | CW28B0984   | 11       | FF28B0121     | 17     |
| 28B2945     | 15     | CA25B1642    | 29     | CW28B1500   | 10       | FF28B1240     | 17     |
| 28B3149     | 19     | CA25B1937    | 29     | CW28B1501   | 10       | FF28B1265     | 17     |
| 28B3170     | 15     | CA25B2000    | 29     | CW28B1642   | 10       | FF28B1729     | 17     |
| 28B4100     | 15     | CA25B4000    | 29     | CW28B1805   | 10       | FF28B1785     | 18     |
| 28B5945     | 15     | CA28B0642    | 11     | CW28B1937   | 10       | FF28B2375     | 17     |
| 28B5950     | 15     | CA28B0805    | 11     | CW28B1984   | 10       | FF28B2440     | 21     |
| 28B9210     | 15     | CA28B0937    | 11     | CW28B2000   | 10       | FF28B2480     | 17     |
| 28R0760     | 19     | CA28B0984    | 11     | EK20B0009   | 30       | FF28B2500     | 18     |
| 28R1127     | 19     | CA28B1500    | 10,29  | EK25B0012   | 30       | FF28B2940     | 21     |
| 28R1127-2   | 19     | CA28B1501    | 10,29  | EK28B0021   | 30       | FF28B3000     | 18     |
| 28R1260     | 19     | CA28B1642    | 10,29  | EK28B0032   | 30       | FF28B3012     | 17     |
| 28R1531     | 19,21  | CA28B1805    | 10,29  | EK28B27SB   | 30       | FF33B2480     | 23     |
| 28R1575     | 19     | CA28B1937    | 10,29  | EK33B0011   | 30       | FX28R0984-0/A | 19     |
| 28R1953     | 19     | CA28B1984    | 10,29  | ET20B2000   | 31       | FX28R0984-2/A | 19     |
| 28R2300     | 19     | CA28B2000    | 10,29  | ET25B2000   | 31       | FX28R1261-2/A | 19     |
| AS20B2030   | 26,29  | CA28B4000    | 29     | ET28B2000   | 31       | FX28R1450-1/A | 19     |
| AS20B2033   | 26,29  | CF28B0642    | 11     | ET28B3000   | 31       | FX28R1457-4/A | 19     |
| AS20B2034   | 26,29  | CF28B0805    | 11     | ET33B2000   | 31       |               |        |



Each part number is a standard stock item and is carried in our inventories at all times for immediate delivery.

| Part Number      | Page # | Part Number    | Page # | Part Number    | Page # | Part Number  | Page #   |
|------------------|--------|----------------|--------|----------------|--------|--------------|----------|
| HA28B2038        | 13     | SB28B0071      | 20     | SB28B2043AT/AB | 20     | SS25B2036    | 24       |
| HA28B2039        | 13     | SB28B0071AB/AT | 20     | SB28B2100      | 20     | SS25B2037    | 24,29    |
| HF28B2038        | 13     | SB28B0121      | 20     | SB28B2100-1    | 20     | SS25B2040    | 24       |
| HF28B2039        | 13     | SB28B0121AB/AT | 20     | SB28B2100-1AB  | 20     | SS28B2027    | 12       |
| HI28B2038        | 13     | SB28B0146      | 20     | SB28B2100AB    | 20     | SS28B2030    | 12,29    |
| HI28B2039        | 13     | SB28B0146AB/AT | 20     | SB28B2375      | 20     | SS28B2031    | 12,14    |
| HW28B2038        | 13     | SB28B0221      | 20     | SB28B2375AT/AB | 20     | SS28B2032    | 12,29    |
| HW28B2039        | 13     | SB28B0221AT/AB | 20     | SB28B2480      | 20     | SS28B2033    | 12,29    |
| IL25B0642W/G/B/K | 24     | SB28B0500      | 20     | SB28B2480AT/AB | 20     | SS28B2034    | 12,14,29 |
| IL28B0642W/G/B/K | 12     | SB28B0500-1    | 20     | SB28B3012      | 20     | SS28B2035    | 12,14    |
| JB28B0010        | 12     | SB28B0500-1AB  | 20     | SB28B3012AT/AB | 20     | SS28B2035-15 | 18       |
| PM28B0625        | 14     | SB28B0500AB    | 20     | SB28B3500      | 20     | SS28B2035-2  | 14       |
| PM28B0686        | 14     | SB28B0550      | 20     | SB28B3500AT/AB | 20     | SS28B2035-3  | 14       |
| PM28B0736        | 14     | SB28B0550AB    | 20     | SB28B4340      | 20     | SS28B2036    | 12       |
| PM28B1625        | 14     | SB28B0617      | 20     | SB28B4340AT/AB | 20     | SS28B2037    | 12,29    |
| PM28B3375        | 14     | SB28B0617AB    | 20     | SB28B5630      | 14,21  | SS28B2040    | 12       |
| RA20B1729        | 27,29  | SB28B0642      | 20     | SB28B5630A     | 14,21  | SS28B2041    | 12,29    |
| RA20B2480        | 27,29  | SB28B0642AB    | 20     | SE20B1729      | 27     | SS28B2042    | 12,29    |
| RA25B2480        | 25,29  | SB28B0805      | 20     | SE20B2480      | 27     | SS28B2043    | 12       |
| RA25B4340        | 25,29  | SB28B0805AB    | 20     | SE25B0121      | 25     | SS28B2044    | 12       |
| RA28B0765        | 16     | SB28B0875      | 20     | SE25B2480      | 25     | SS33B2030    | 22       |
| RA28B1265        | 16     | SB28B0875-1    | 20     | SE25B4340      | 25     | SS33B2032    | 22       |
| RA28B1729        | 16,29  | SB28B0875-1AB  | 20     | SE28B0071      | 17     | SS33B2033    | 22       |
| RA28B2265        | 16     | SB28B0875AB    | 20     | SE28B0121      | 17     | SS33B2035    | 22       |
| RA28B2480        | 16,29  | SB28B0937      | 20     | SE28B0146      | 17     | SS33B2036    | 22       |
| RA28B3012        | 16,29  | SB28B0937AB    | 20     | SE28B0221      | 17     | SS33B2037    | 22       |
| RA28B4340        | 16,29  | SB28B0984      | 20     | SE28B1240      | 17     | SS33B2040    | 22       |
| RA33B2480        | 23     | SB28B0984AB    | 20     | SE28B1729      | 17     | TC20B1500    | 26       |
| RA33B4340        | 23     | SB28B1055      | 20     | SE28B2480      | 17     | TC20B2000    | 26       |
| RC20B1729        | 27,29  | SB28B1055-1    | 20     | SE28B3012      | 17     | TC25B0642    | 24       |
| RC20B2480        | 27,29  | SB28B1055-1AB  | 20     | SE28B3500      | 17     | TC25B0937    | 24       |
| RC25B2480        | 25,29  | SB28B1055AB    | 20     | SE28B4340      | 17     | TC25B1500    | 24       |
| RC25B4340        | 25,29  | SB28B1123      | 20     | SE33B2480      | 23     | TC25B2000    | 24       |
| RC28B0765        | 16     | SB28B1123AB    | 20     | SE33B4340      | 23     | TC28B0550    | 11       |
| RC28B1265        | 16     | SB28B1251      | 20     | SM20R1260      | 27     | TC28B0617    | 11       |
| RC28B1729        | 16,29  | SB28B1251AB    | 20     | SM20R1575      | 27     | TC28B0642    | 11       |
| RC28B2265        | 16     | SB28B1500      | 20     | SM28B0785      | 19,21  | TC28B0805    | 11       |
| RC28B2480        | 16,29  | SB28B1500AB    | 20     | SM28B1101      | 19     | TC28B0937    | 11       |
| RC28B3012        | 16,29  | SB28B1501      | 20     | SM28B1775      | 19     | TC28B0984    | 11       |
| RC28B4340        | 16,29  | SB28B1501AB    | 20     | SM28B1775-1    | 19     | TC28B1123    | 11       |
| RC33B2480        | 23     | SB28B1729      | 20     | SM28B1779      | 19     | TC28B1251    | 11       |
| RC33B4340        | 23     | SB28B1729AT/AB | 20     | SM28B2002      | 19,21  | TC28B1500    | 11       |
| SA20B1729        | 27     | SB28B2000      | 20     | SM28B2170-1    | 19     | TC28B1501    | 11       |
| SA20B2480        | 27     | SB28B2000AB    | 20     | SM28B3149      | 19     | TC28B2000    | 11       |
| SA25B0121        | 25     | SB28B2027      | 20     | SM28R0760      | 19     | TC33B0805    | 22       |
| SA25B2480        | 25     | SB28B2027AT/AB | 20     | SM28R1127      | 19     | TC33B0984    | 22       |
| SA25B4340        | 25     | SB28B2030      | 20     | SM28R1127-2    | 19     | TC33B2000    | 22       |
| SA28B0071        | 17     | SB28B2030AT/AB | 20     | SM28R1260      | 19     | USB28B2034   | 13       |
| SA28B0121        | 17     | SB28B2031      | 20     | SM28R1531      | 19,21  | USB28B2034A  | 13       |
| SA28B0146        | 17     | SB28B2031AT/AB | 20     | SM28R1575      | 19     | USB28B2034K  | 13       |
| SA28B0221        | 17     | SB28B2032      | 20     | SM28R1953      | 19     | USB28B2034KA | 13       |
| SA28B1240        | 17     | SB28B2032AT/AB | 20     | SM28R2300      | 19     |              |          |
| SA28B1729        | 17     | SB28B2034      | 20     | SS20B2030      | 26,29  |              |          |
| SA28B2480        | 17     | SB28B2034AT/AB | 20     | SS20B2033      | 26,29  |              |          |
| SA28B3012        | 17     | SB28B2035      | 20     | SS20B2034      | 26,29  |              |          |
| SA28B3500        | 17     | SB28B2035AT/AB | 20     | SS20B2037      | 26,29  |              |          |
| SA28B4340        | 17     | SB28B2039      | 20     | SS20B2041      | 26,29  |              |          |
| SA33B2480        | 23     | SB28B2039AT/AB | 20     | SS20B2042      | 26,29  |              |          |
| SA33B4340        | 23     | SB28B2041      | 20     | SS25B2030      | 24,29  |              |          |
| SB28B0010        | 20     | SB28B2041AT/AB | 20     | SS25B2032      | 24,29  |              |          |
| SB28B0010AB/AT   | 20     | SB28B2043      | 20     | SS25B2033      | 24,29  |              |          |

# WE'VE GOT YOU COVERED

## Reliable Board, Enclosure and Cable Shielding Solutions

Leader Tech is a world-leading innovator and US-based manufacturer of EMI shielding products for circuit boards, enclosures and cables. In addition to our best selling standard, modified standard and custom CBS shields, Leader Tech offers an expansive line of beryllium copper fingerstock gaskets, conductive elastomers, advanced RF absorber materials and EMI/RFI ferrites.



EMI Enclosure Solutions Catalog



CBS Circuit Board Shielding Catalog

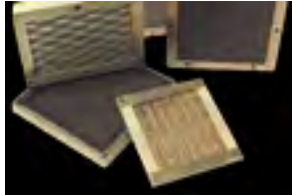
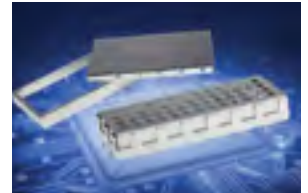

## LEADERTECH SHIELDING PRODUCTS

### Board Level Shielding

- Standard and Multi-Cavity CBS
- Modified Standard Options
- Custom Circuit Board Shields

### FerriShield Ferrites

- Snap-On Bisected & Solid Bead Ferrites
- Round & Flat Styles for Cables, Wires and Flex Circuits
- Low, High, Microwave and Wideband Frequency-Specific Material

### Enclosure Shielding

- BeCu Fingerstock Gaskets
- TechSIL 5000 Conductive Elastomers
- Conductive Fabric Shielding Gaskets
- TechSIL 8000 Oriented Wire Gaskets
- TechMESH Knitted Wire Gaskets
- TechMESH Combo Strip & Gaskets
- TechVent Honeycomb Shielding Panels

## EMI PROBLEM?

Our sales engineers are waiting for your call: 866-TECH-EMI (866-832-4364)

Visit our web site today to browse our complete product line, download literature and find your local sales engineer or sales representative! [www.leadertechinc.com](http://www.leadertechinc.com)



# STANDARD PRODUCTS

## Part Number Explanation

|            |               |               |              |                |
|------------|---------------|---------------|--------------|----------------|
| Part Style | Material Type | Ferrite Shape | Ferrite Size | Special Option |
|            |               |               |              |                |
| SS         | 28            | B             | 2031         | K              |

## Color

All plastic components are supplied in PMS #413 computer gray unless shown in photos as natural white or black. Black is optional where indicated.

## Custom Products

Engineering support is always available for special designs and evaluations.

## Samples

Most items on catalog pages 10 through 27 are available from stock on a complimentary basis.

## Commercial and Government Entity Code (CAGE CODE): 4J674

## Quality System

ISO 9001:2008 certified.

## Delivery

*All items are normally available from stock at all times for immediate delivery.*

## RoHS Directive

All FerriShield products are in compliance with the European Commission RoHS Directive, Restriction of use of certain Hazardous Substances, dated July, 1 2006. FerriShield products do not contain any of the six restricted substances; namely, lead, cadmium, mercury, hexavalent chromium, PBB or PBDE flame retardant.

## Customer Service

For quotes, technical information or personal assistance, contact:



12420 Race Track Road, Tampa, Florida 33626  
 www.leadertechinc.com • sales@leadertechinc.com  
 866.TECH.EMI (866.832.4364) • Local: 813.855.6921  
 Fax: 813.855.3291



STATEMENT OF LIEU OF WARRANTY: All technical information and data in this document is based on tests and is believed to be accurate and reliable. Nevertheless, since the products described herein are not provided to conform with mutually accepted specifications and the use thereof is unknown, the manufacturer and seller of the products do not guarantee results, freedom from patent infringement, or suitability of the products for any application thereof. The manufacturer and seller of the products described in this document will provide all possible technical assistance and will replace any products proven defective. No statement or recommendations made by the manufacturer or seller not contained herein shall have any force of effect unless in conformity with an agreement signed by an officer of the seller and manufacturer. Product testing by the purchaser is recommended in order to confirm expected results.

[www.LEADERTECHINC.COM](http://www.LEADERTECHINC.COM)

*A passion in all we do*



**LEADER  
TECH**   
a HEICO company

12420 Race Track Rd.  
Tampa, Florida 33626

866.TECH.EMI (866.832.4364)

Tel: 813.855.6921

Fax: 813.855.3291

[www.leadertechinc.com](http://www.leadertechinc.com)

F071

ISO 9001: 2008  
CERTIFIED

 **RoHS**  
COMPLIANT





## Стандарт Электрон Связь

Мы молодая и активно развивающаяся компания в области поставок электронных компонентов. Мы поставляем электронные компоненты отечественного и импортного производства напрямую от производителей и с крупнейших складов мира.

Благодаря сотрудничеству с мировыми поставщиками мы осуществляем комплексные и плановые поставки широчайшего спектра электронных компонентов.

Собственная эффективная логистика и склад в обеспечивает надежную поставку продукции в точно указанные сроки по всей России.

Мы осуществляем техническую поддержку нашим клиентам и предпродажную проверку качества продукции. На все поставляемые продукты мы предоставляем гарантию .

Осуществляем поставки продукции под контролем ВП МО РФ на предприятия военно-промышленного комплекса России , а также работаем в рамках 275 ФЗ с открытием отдельных счетов в уполномоченном банке. Система менеджмента качества компании соответствует требованиям ГОСТ ISO 9001.

Минимальные сроки поставки, гибкие цены, неограниченный ассортимент и индивидуальный подход к клиентам являются основой для выстраивания долгосрочного и эффективного сотрудничества с предприятиями радиоэлектронной промышленности, предприятиями ВПК и научно-исследовательскими институтами России.

С нами вы становитесь еще успешнее!

### Наши контакты:

**Телефон:** +7 812 627 14 35

**Электронная почта:** [sales@st-electron.ru](mailto:sales@st-electron.ru)

**Адрес:** 198099, Санкт-Петербург,  
Промышленная ул, дом № 19, литера Н,  
помещение 100-Н Офис 331