

### RoHS MHS Varistor Series

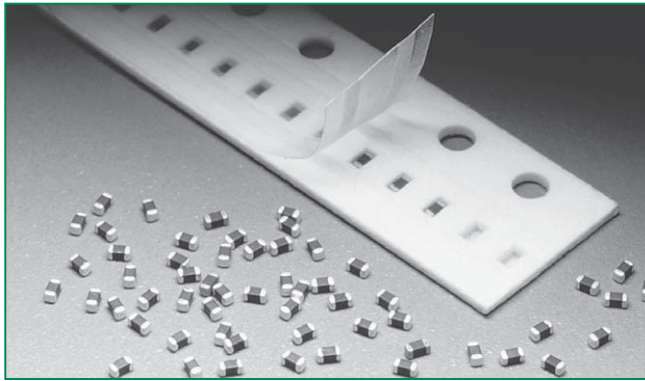

#### Size Table

Metric	EIA
1005	0402
1608	0603

#### Applications

- Data, Diagnostic I/O Ports
- Universal Serial Bus (USB)
- Video & Audio Ports
- Portable/Hand-Held Products
- Mobile Communications
- Computer/DSP Products
- Industrial Instruments Including Medical

#### Description

The Multilayer High-Speed MHS Series is a very-low capacitance extension to the Littelfuse ML family of transient voltage surge suppression devices available in an 0402 and 0603-size surface mount chip.

The MHS Series provides protection from ESD and EFT in high-speed data line and other high frequency applications. The low capacitance of the MHS Series permits usage in analog or digital circuits where it will not attenuate or distort the desired signal or data.

Their small size is ideal for high-density printed circuit boards, being typically applied to protect intergrated circuits and other sensitive components. They are particularly well suited to suppress ESD events including those specified in IEC 61000-4-2 or other standards used for Electromagnetic Compliance (EMC) testing.

The MHS Series is manufactured from semiconducting ceramics and is supplied in a leadless, surface mount package. The MHS Series is also compatible with modern reflow and wave soldering processes.

Littelfuse Inc. manufactures other multilayer varistor series products, see the ML, MLE, MLN and AUML Series data sheets.

#### Features

- AEC - Q200 compliant
- RoHS compliant
- 3pF, 12pF, and 22pF capacitance versions suitable for high-speed data rate lines
- ESD rated to IEC 61000-4-2 (Level 4)
- EFT/B rated to IEC 61000-4-4 (Level 4)
- Low leakage currents
- -55°C to +125°C operating temp. range
- Inherently bi-directional

#### Absolute Maximum Ratings

• For ratings of individual members of a series, see device ratings and specifications table.

Continuous	MHS Series	Units
Steady State Applied Voltage:		
DC Voltage Range ( $V_{MDC}$ ) :	V0402/0603MHS03	≤ 42 V
	V0402/0603MHS12	≤ 18 V
	V0402/0603MHS22	≤ 09 V
Operating Ambient Temperature Range ( $T_A$ )		-55 to +125 °C
Storage Temperature Range ( $T_{STG}$ )		-55 to +150 °C

### Device Ratings and Specifications

Part Number	Performance Specifications (25 °C)							
	Maximum Clamping Voltage At 1A (8X20 $\mu$ s)	Maximum ESD Clamp Voltage (Note 1)		Typical Leakage Current at Specified DC Voltage		Typical Capacitance at 1MHz (1V p-p)		Typical Inductance (from Impedance Analysis)
		8kV Contact (Note 2)	15kV AIR (Note 3)	3.5V	5.5V	C (Note 4)		
		Clamp	Clamp	P	I <sub>L</sub>	MIN	MAX	
(V <sub>c</sub> )	(V)	(V)	( $\mu$ A)	( $\mu$ A)	(pF)	(pF)	L	
V0402MHS03N (Note 5)	135	<300	<400	0.5	1.00	2	5	<1.0
V0603MHS03N	135	<300	<400	0.5	1.00	1	6	<1.0
V0402MHS12N (Note 5)	55	<125	<160	0.5	1.00	8	16	<1.0
V0603MHS12N	55	<125	<160	0.5	1.00	8	16	<1.0
V0402MHS22N (Note 5)	30	<125	<160	0.5	1.00	15	29	<1.0
V0603MHS22N	30	<65	<100	0.5	1.00	15	29	<1.0

NOTES:

1. Tested to IEC-61000-4-2 Human Body Model (HBM) discharge test circuit.
2. Direct discharge to device terminals (IEC preferred test method).
3. Corona discharge through air (represents actual ESD event).
4. Capacitance may be customized, contact your Littelfuse Sales Representative.
5. V0402MHSxxx (0402 size devices) available as "R" packaging option only. Example: V0402MHS03NR. See Packaging and Tape and Reel sections (last page) for additional information.

### Peak Current and Energy Derating Curve

For applications exceeding 125°C ambient temperature, the peak surge current and energy ratings must be reduced as shown below.

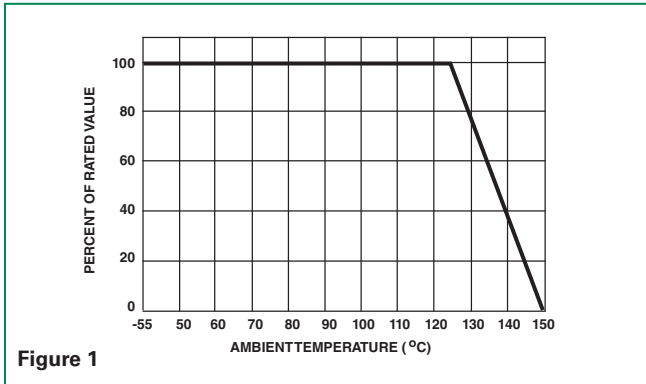

Figure 1

### Standby Current at Normalized Varistor Voltage and Temperature

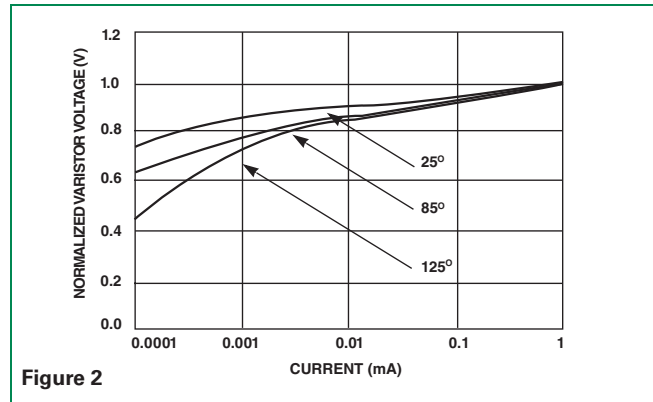

Figure 2

### Nominal Voltage Stability to Multiple ESD Impulses (8kV Contact Discharges per IEC 61000-4-2)

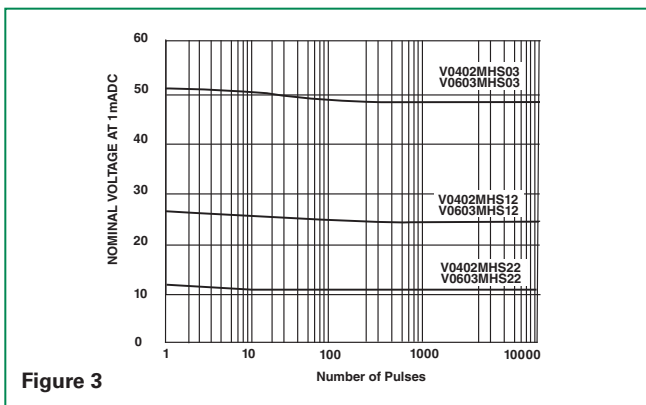

Figure 3

### Insertion Loss (S21) Characteristics

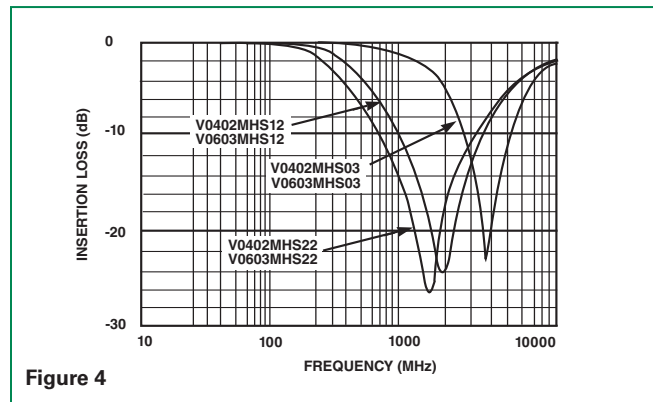
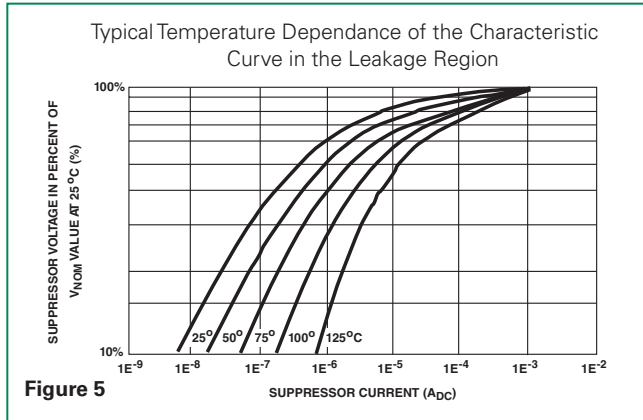

Figure 4

### Device Characteristics

At low current levels, the V-I curve of the multilayer transient voltage suppressor approaches a linear (ohmic) relationship and shows a temperature dependent effect. At or below the maximum working voltage, the suppressor is in a high resistance model (approaching  $10^6\Omega$  at its maximum rated working voltage). Leakage currents at maximum rated voltage are below  $100\mu A$ , typically  $25\mu A$ ; for 0402 size below  $20\mu A$ , typically  $5\mu A$ .



### Speed of Response

The Multilayer Suppressor is a leadless device. Its response time is not limited by the parasitic lead inductances found in other surface mount packages. The response time of the  $Z_{N}O$  dielectric material is less than 1ns and the MLE can clamp very fast dV/dT events such as ESD. Additionally, in "real world" applications, the associated circuit wiring is often the greatest factor effecting speed of response. Therefore, transient suppressor placement within a circuit can be considered important in certain instances.

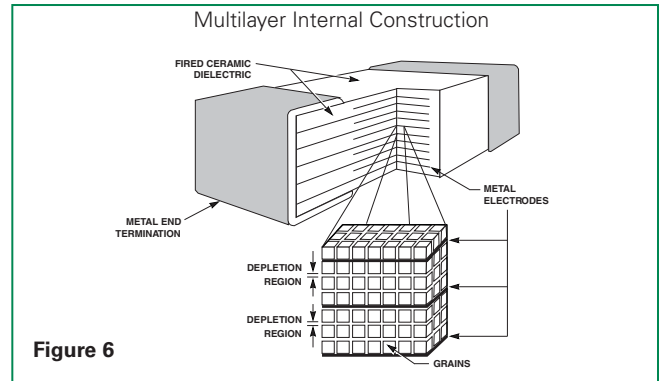

MHS Series

### Lead (Pb) Soldering Recommendations

The principal techniques used for the soldering of components in surface mount technology are IR Re-flow and Wave soldering. Typical profiles are shown on the right.

The recommended solder for the MHS suppressor is a 62/36/2 (Sn/Pb/Ag), 60/40 (Sn/Pb) or 63/37 (Sn/Pb). Littelfuse also recommends an RMA solder flux.

Wave soldering is the most strenuous of the processes. To avoid the possibility of generating stresses due to thermal shock, a preheat stage in the soldering process is recommended, and the peak temperature of the solder process should be rigidly controlled.

When using a reflow process, care should be taken to ensure that the MHS chip is not subjected to a thermal gradient steeper than 4 degrees per second; the ideal gradient being 2 degrees per second. During the soldering process, preheating to within 100 degrees of the solder's peak temperature is essential to minimize thermal shock.

Once the soldering process has been completed, it is still necessary to ensure that any further thermal shocks are avoided. One possible cause of thermal shock is hot printed circuit boards being removed from the solder process and subjected to cleaning solvents at room temperature. The boards must be allowed to cool gradually to less than 50°C before cleaning.

### Reflow Solder Profile

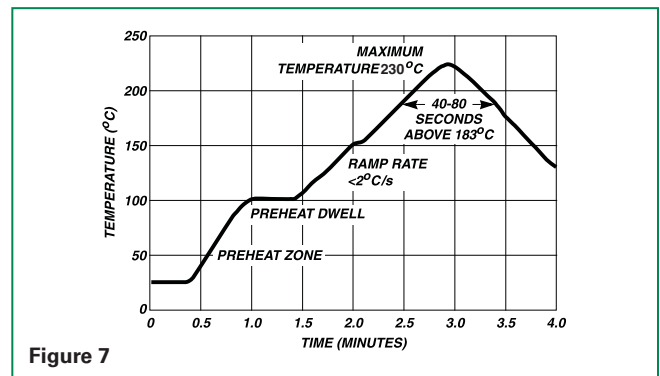

### Wave Solder Profile

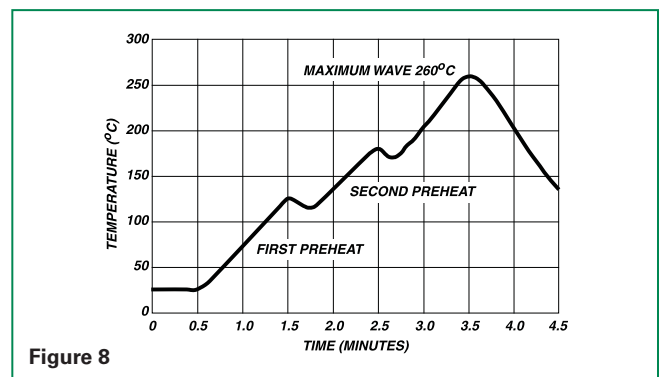

### Lead-free (Pb-free) Soldering Recommendations

Littelfuse offers the Nickel Barrier Termination finish for the optimum Lead-free solder performance.

The preferred solder is 96.5/3.0/0.5 (SnAgCu) with an RMA flux, but there is a wide selection of pastes and fluxes available with which the Nickel Barrier parts should be compatible.

The reflow profile must be constrained by the maximums in the Lead-free Reflow Profile. For Lead-free wave soldering, the Wave Solder Profile still applies.

Note: the Lead-free paste, flux and profile were used for evaluation purposes by Littelfuse, based upon industry standards and practices. There are multiple choices of all three available, it is advised that the customer explores the optimum combination for their process as processes vary considerably from site to site.

### Lead-free Re-flow Profile

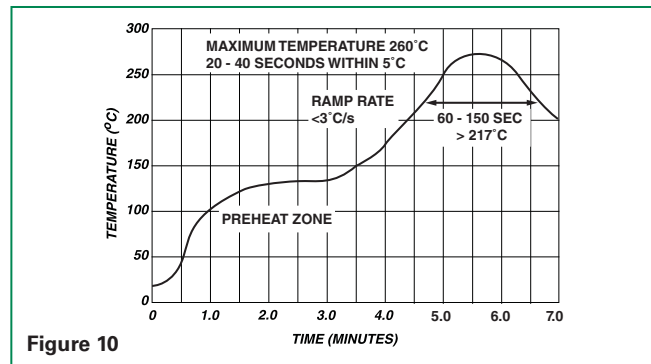

### Product Dimensions (mm)

PAD LAYOUT DIMENSIONS

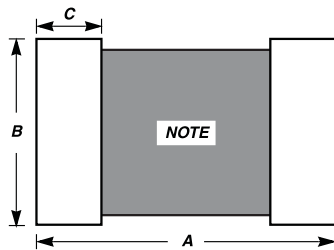

Note: Avoid metal runs in this area, parts are not recommended for use in applications using Silver (Ag) epoxy paste.

CHIP LAYOUT DIMENSIONS

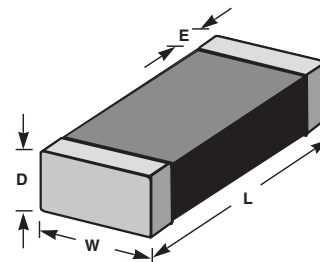

Dimension	0402 Size		0603 Size	
	IN	MM	IN	MM
<b>A</b>	0.067	1.700	0.100	2.540
<b>B</b>	0.020	0.510	0.030	0.760
<b>C</b>	0.024	0.610	0.035	0.890
<b>D (max.)</b>	0.024	0.600	0.040	1.000
<b>E</b>	0.10 +/- 0.006	0.25 +/- 0.15	0.015 +/- 0.008	0.4 +/- 0.2
<b>L</b>	0.039 +/- 0.004	1.00 +/- 0.10	0.063 +/- 0.006	1.6 +/- 0.15
<b>W</b>	0.020 +/- 0.004	0.50 +/- 0.10	0.032 +/- 0.006	0.8 +/- 0.15

### Part Numbering System

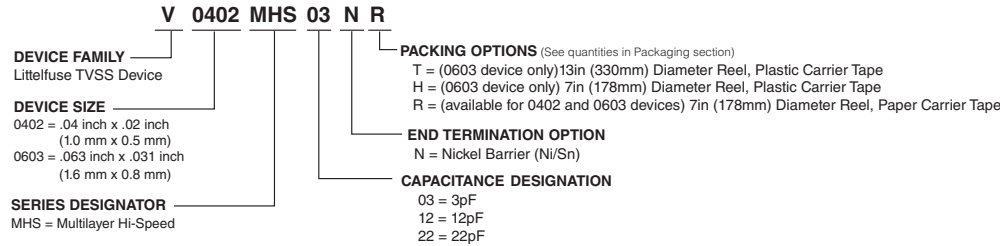

### Packaging\*

Device Size	Quantity		
	13 Inch Reel ("T" Option)	7 Inch Reel ("H" Option)	7 Inch Reel ("R" Option)
0603	10,000	2,500	4,000
0402	not available	not available	10,000

\*(Packaging) It is recommended that parts be kept in the sealed bag provided and that parts be used as soon as possible when removed from bags.

### Tape and Reel Specifications

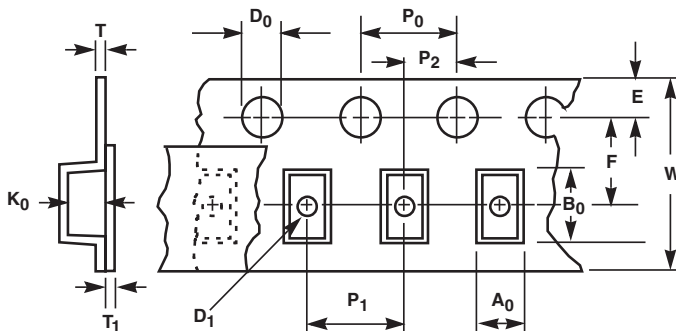

Symbol	Description	Dimensions in Millimeters	
		0402 Size	0603 Size
A <sub>0</sub>	Width of Cavity	Dependent on Chip Size to Minimize Rotation.	
B <sub>0</sub>	Length of Cavity	Dependent on Chip Size to Minimize Rotation.	
K <sub>0</sub>	Depth of Cavity	Dependent on Chip Size to Minimize Rotation.	
W	Width of Tape	8 +/- 0.2	8 +/- 0.3
F	Distance Between Drive Hole Centers and Cavity Centers	3.5 +/- .05	3.5 +/- .05
E	Distance Between Drive Hole Centers and Tape Edge	1.75 +/- 0.1	1.75 +/- 0.1
P <sub>1</sub>	Distance Between Cavity Centers	2 +/- 0.05	4 +/- 0.1
P <sub>2</sub>	Axial Drive Distance Between Drive Hole Centers & Cavity Centers	2 +/- 0.1	2 +/- 0.1
P <sub>0</sub>	Axial Drive Distance Between Drive Hole Centers	4 +/- 0.1	4 +/- 0.1
D <sub>0</sub>	Drive Hole Diameter	1.55 +/- 0.05	1.55 +/- 0.05
D <sub>1</sub>	Diameter of Cavity Piercing	N/A	1.05 +/- 0.05
T <sub>1</sub>	Top Tape Thickness	0.1 Max	0.1 Max
T	Nominal Carrier Tape Thickness	1.1	1.1

Notes:

- Conforms to EIA-481-1, Revision A
- Can be supplied to IEC publication 286-3

©2010 Littelfuse, Inc.

Specifications are subject to change without notice.  
Please refer to [www.littelfuse.com/series/MHS.html](http://www.littelfuse.com/series/MHS.html) for current information.

Revision: June 28, 2010

MHS Varistor Series



**Стандарт  
Электрон  
Связь**

Мы молодая и активно развивающаяся компания в области поставок электронных компонентов. Мы поставляем электронные компоненты отечественного и импортного производства напрямую от производителей и с крупнейших складов мира.

Благодаря сотрудничеству с мировыми поставщиками мы осуществляем комплексные и плановые поставки широчайшего спектра электронных компонентов.

Собственная эффективная логистика и склад в обеспечивает надежную поставку продукции в точно указанные сроки по всей России.

Мы осуществляем техническую поддержку нашим клиентам и предпродажную проверку качества продукции. На все поставляемые продукты мы предоставляем гарантию .

Осуществляем поставки продукции под контролем ВП МО РФ на предприятия военно-промышленного комплекса России , а также работаем в рамках 275 ФЗ с открытием отдельных счетов в уполномоченном банке. Система менеджмента качества компании соответствует требованиям ГОСТ ISO 9001.

Минимальные сроки поставки, гибкие цены, неограниченный ассортимент и индивидуальный подход к клиентам являются основой для выстраивания долгосрочного и эффективного сотрудничества с предприятиями радиоэлектронной промышленности, предприятиями ВПК и научно-исследовательскими институтами России.

С нами вы становитесь еще успешнее!

**Наши контакты:**

**Телефон:** +7 812 627 14 35

**Электронная почта:** [sales@st-electron.ru](mailto:sales@st-electron.ru)

**Адрес:** 198099, Санкт-Петербург,  
Промышленная ул, дом № 19, литера Н,  
помещение 100-Н Офис 331